

## MET 1-PHASE CONTROL AND ISOLATION TRANSFORMER

P: 4000VA IN: 400VAC+/- 5% OUT: 230VAC

Single-phase - Control and Isolation Transformers  
4000 VA  
Isolation class T 40/B

### [Link to Product](#)

#### Illustration

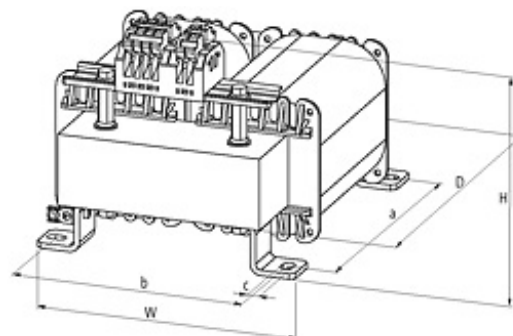
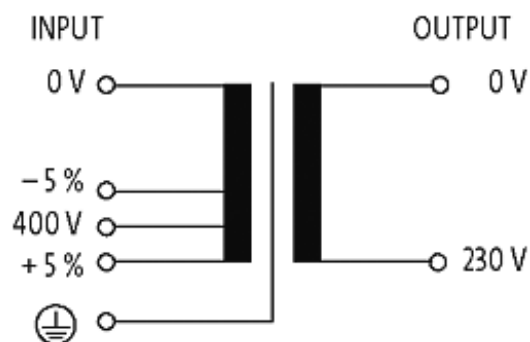

Product may differ from image

Product may differ from image

### Approvals



### Input

Input voltage	400 V AC $\pm$ 5 %
Frequency	50...60 Hz
Short-circuit current	480.8 A (400 V AC)
Input current	10.32 A (400 V AC)
Inrush current	186.7 A (400 V AC)

### General data

Standards	(EN 61558-1), (EN 61558-2-4), (EN 62041 category 0)
Test isolation voltage	4 kV (prim./sec.)
Dimensions H x W x D	206x198x250 mm
Fixing centers a x b x c	200x174x9 mm
Drill hole $\varnothing$	9x14 mm
Mounting method	Long-hole mounting
Temperature range	-20...+40 °C, no condensation

### Output

Output voltage	230 V AC
----------------	----------

### Commercial data

country of origin	CZ
customs tariff number	85043200
minimum order quantity	1