

## Technisches Datenblatt

Artnr.	GEL12-24HL-BS
Japan-Code	CTX24HL-BS
Nennspannung	12V
Nennkapazität	24 AH (c20)
Kälteprüfstrom -18°C (EN)	335 A (EN)
Elektrolyt	verdünnte Schwefelsäure diluted sulphuric acid
Elektrolytdichte	1,28+/- 0,01 Kg/l (25°)
Abmessungen (LxBxH)	205 x 87 x 162 mm
Schaltung	0

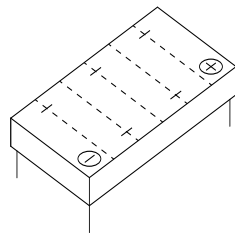
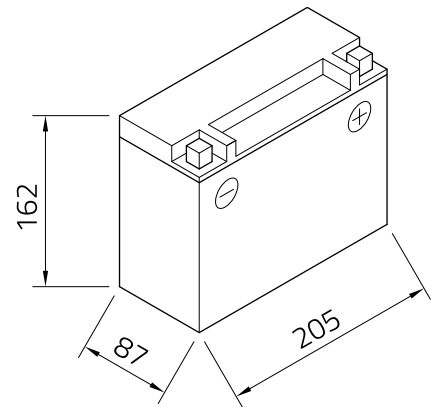

Technologie	Verschlussene GEL-Batterie   Elektrolyt gelartig gebunden   gefüllt und geladen   absolut wartungsfrei
-------------	--

Polausführung	A
---------------	---

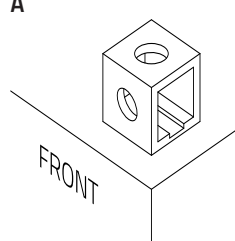

Bodenleiste	-
-------------	---