

C-Washers • DIN 6372

22290.0020



Product Description

The c-washers (slotted washers) are manufactured according to DIN 6372. For better handling, the c-washers have a knurling all around.

Material

- Heat-treated steel, tempered, blackened

Drawing

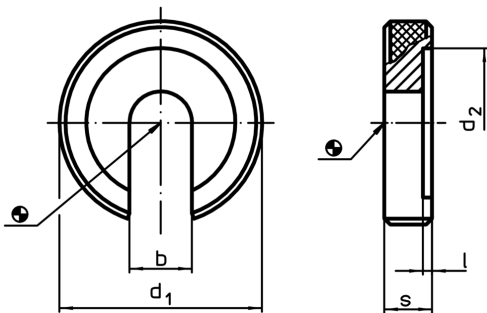

Order information

Nominal size [mm]	Dimensions					Art. No.
	b	d ₁	d ₂ [mm]	l	s	
20	21	64	45	2	14	22290.0020

Application example

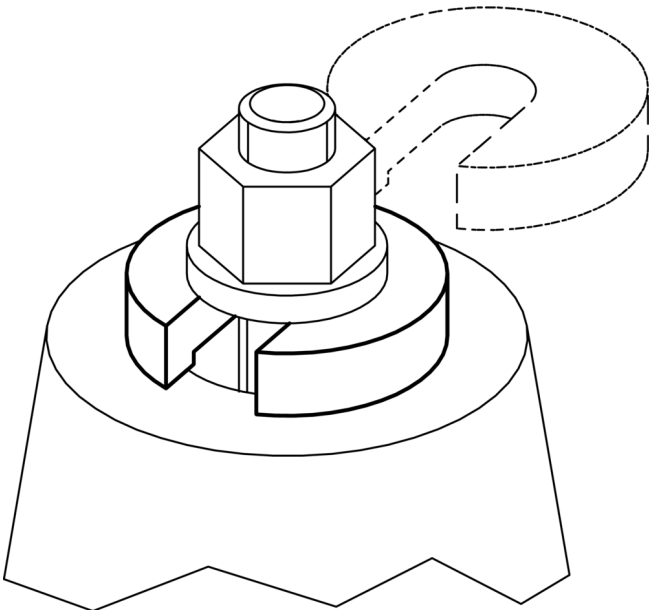

Compliance

RoHS compliant

Compliant according to Directive 2011/65/EU and Directive 2015/863

Does not contain SVHC substances

No SVHC substances with more than 0.1% w/w contained - SVHC list [REACH] as of 10.06.2022

Does not contain Proposition 65 substances

No Proposition 65 substances included
<https://www.P65Warnings.ca.gov/>

Free from Conflict Minerals

This product does not contain any substances designated as "conflict minerals" such as tantalum, tin, gold or tungsten from the Democratic Republic of Congo or adjacent countries.