

OMNIMATE Data - RJ45 jacks transformer RJ45M R1V 3.3N4YG/YG TY

Weidmüller Interface GmbH & Co. KG
Klingenbergstraße 16
D-32758 Detmold
Germany
Fon: +49 5231 14-0
Fax: +49 5231 14-292083
www.weidmueller.com



RJ45 transmitter sockets (magnetics) for gigabit applications (1000 base-T) with integrated compensation actively counteracts inductive and capacitive couplings and saves space on the PCB.

- THT or THR soldering processes
- Wide range of different design types, also with integrated LEDs and shield contact tabs
- Packed either in a tray (TY) or on a roll (tape-on-reel, RL)
- Extended temperature range of -40 °C to +85 °C
- Reinforced gold layer for improved corrosion protection
- Transmission rates of up to 1 Gbit/s

General ordering data

Type	RJ45M R1V 3.3N4YG/YG TY
Order No.	1534750000
Version	PCB plug-in connector, RJ45 jacks transformer, THT/THR solder connection, 1.27 mm, No. of poles: 8, 180°, Solder pin length (l): 3.2 mm, Gold over nickel, Black, Tray (manual assembly)
GTIN (EAN)	4050118338416
Qty.	120 pc(s).
Packaging	Tray (manual assembly)

**OMNIMATE Data - RJ45 jacks transformer
RJ45M R1V 3.3N4YG/YG TY**

Weidmüller Interface GmbH & Co. KG
 Klingenbergstraße 16
 D-32758 Detmold
 Germany
 Fon: +49 5231 14-0
 Fax: +49 5231 14-292083
 www.weidmueller.com

Technical data**Dimensions and weights**

Net weight	4.208 g
------------	---------

Temperatures

Operating temperature, max.	85 °C	Operating temperature, min.	-40 °C
Storage temperature, max.	85 °C	Storage temperature, min.	-40 °C

System specifications

Colour of left LED	green / yellow	Colour of right LED	green / yellow
LED	Yes	Mounting onto the PCB	THT/THR solder connection
No. of poles	8	Number of solder pins per pole	1
Outgoing elbow	180°	Packaging	Tray (manual assembly)
Pitch in inches (P)	0.05 inch	Pitch in mm (P)	1.27 mm
Plugging cycles	750	Product family	OMNIMATE Data - RJ45 jacks transformer
Protection degree	IP20	Shield surface	nickel-plated
Shield tabs	none	Shielding	Yes
Shielding material	Brass	Solder eyelet hole diameter (D)	0.9 mm
Solder eyelet hole diameter tolerance (D)	± 0.1 mm	Solder pin dimensions	0.40 x 0.30 mm, LED pins = 0.50 x 0.50 mm
Solder pin length (l)	3.2 mm	Transmission rate	10/100 Mbit/s
Type of connection	Socket	Wiring	8-core

Electrical properties

Dielectric strength, contact / contact	≥ 1000 V DC	Insulation resistance	> 500 MΩ
Rated current	1.5 A	Rated voltage	125 V AC

Material data

Insulating material	PA 9T	Colour	Black
Colour chart (similar)	RAL 9011	Insulating material group	II
CTI	≥ 500	Insulation resistance	> 500 MΩ
Moisture Level (MSL)	1	UL 94 flammability rating	V-0
Contact base material	Phosphorus bronze	Contact surface	Gold over nickel
Layer structure of plug contact	30-80 μ" Ni / 30- μ" Au	Storage temperature, min.	-40 °C
Storage temperature, max.	85 °C	Operating temperature, min.	-40 °C
Operating temperature, max.	85 °C		

Classifications

ETIM 6.0	EC002637	eClass 6.2	27-25-05-04
eClass 7.1	27-25-05-04	eClass 8.1	19-17-01-25
eClass 9.0	19-17-01-25		

Approvals

Approvals



ROHS

Conform

Creation date July 2, 2018 10:07:42 AM CEST

Catalogue status 29.06.2018 / We reserve the right to make technical changes.

2

Data sheet**OMNIMATE Data - RJ45 jacks transformer
RJ45M R1V 3.3N4YG/YG TY**

Weidmüller Interface GmbH & Co. KG
Klingenbergstraße 16
D-32758 Detmold
Germany
Fon: +49 5231 14-0
Fax: +49 5231 14-292083
www.weidmueller.com

Technical data**Downloads**

Brochure/Catalogue	MB FREECONTACT EN FL FIELDWIRING EN PI PROFINET CABLING EN
User Documentation	MAN IE GUIDE DE MAN IE GUIDE EN

**OMNIMATE Data - RJ45 jacks transformer
RJ45M R1V 3.3N4YG/YG TY**

Weidmüller Interface GmbH & Co. KG
 Klängenbergstraße 16
 D-32758 Detmold
 Germany
 Fon: +49 5231 14-0
 Fax: +49 5231 14-292083
 www.weidmueller.com

Drawings

Dimensioned drawing

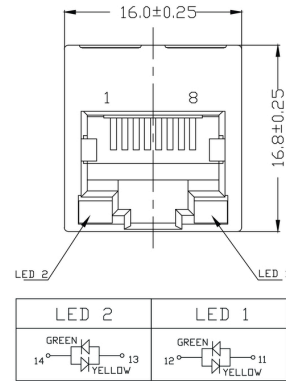

Dimensioned drawing

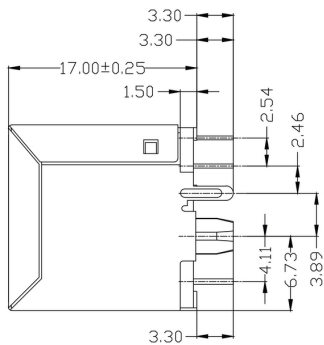

Dimensioned drawing

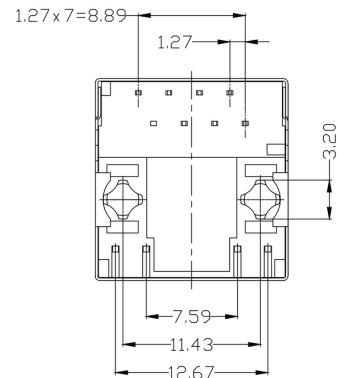

Dimensioned drawing

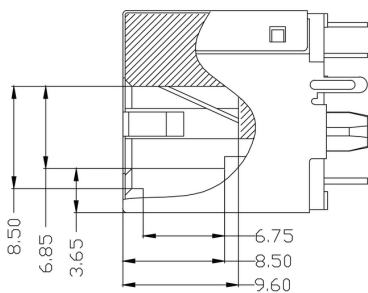

Dimensioned drawing

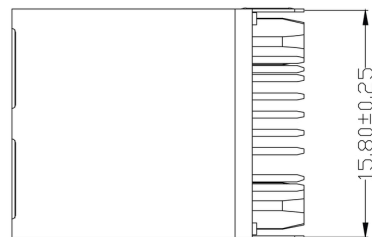

**OMNIMATE Data - RJ45 jacks transformer
RJ45M R1V 3.3N4YG/YG TY**

Weidmüller Interface GmbH & Co. KG
Klingenbergstraße 16
D-32758 Detmold
Germany
Fon: +49 5231 14-0
Fax: +49 5231 14-292083
www.weidmueller.com

Drawings

Wiring diagram

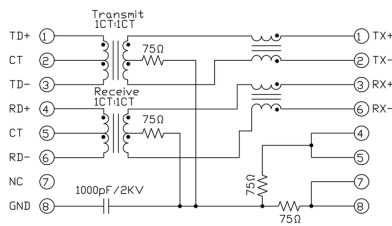

PCB design

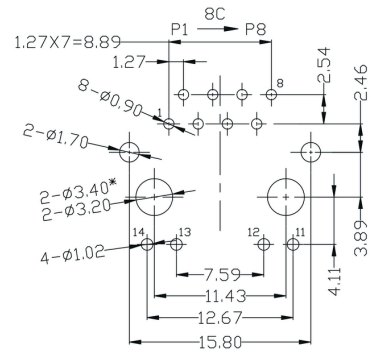

PCB LAYOUT

Miscellaneous

Characteristics

Inductance	350 μH min. @ 100 kHz, 100 mV, 8 mA DC Bias
Leakage Inductance	0.3 μH max. @ 100 kHz, 100 mV
Insertion Loss	1.1 dB max. @ (1 - 100) MHz
Return Loss	18 dB min. @ (1 - 30) MHz 16 dB min. @ (30 - 60) MHz 12 dB min. @ (60 - 80) MHz
Cross Talk	30 dB min. @ (1 - 100) MHz
Common Mode Rejection	30 dB min. @ (1 - 100) MHz

OMNIMATE Data - RJ45 jacks transformer
RJ45M R1V 3.3N4YG/YG TY

Weidmüller Interface GmbH & Co. KG
 Klingenbergstraße 16
 D-32758 Detmold
 Germany
 Fon: +49 5231 14-0
 Fax: +49 5231 14-292083
 www.weidmueller.com

Drawings

Legend

Code	Description	Options
RJ45	Product family	
G1	Performance Category	C5, C6, C6A, C5e, M, G1, G10, U, MP, MP+
R1	Assembly on PCB	R, S, T
U	Direction, latch style	U, D, V, Y
3.2	Solder Pin length	3.2, 1.6, D
E4	EMI tabs (ground fingers)	E, N
4	Contact surface thickness	4
GY/GY	LED	Y/G, G/Y, GY/GY, O/G, R/O, N
TY	Packaging	TY, RL

Code	Description	Options
TY	Packaging	TY: Tray in box (manual assembly) RL: Tape on Reel (automated assembly)
Y/G	LED	Yellow/Green
G/Y	LED	Green/Yellow (standard)
GY/GY	LED	Green-Yellow/Green-Yellow
O/G	LED	Orange/Green
R/O	LED	Red/Orange
N	LED	without LED
4	Contact surface thickness	1 = 3µ", 2 = 6µ", 3 = 15µ", 4 = 30µ", 5 = 50µ"
E	EMI tabs (ground fingers)	E = with EMI tabs N = without EMI tabs
3.2	Solder Pin length	3.2 mm 1.6 mm SMD
U	Direction, latch style	U: Horizontal (90°, side entry), latch up D: Horizontal (90°, side entry), latch down V: Vertical (180°, top entry) Y: Diagonal (45°), latch up
1	Number of Ports	1 Port 12; 14; ... multi ports side by side, Multiport 21; 41; ... multi ports about each other, Multilevel
R	Assembly on PCB	Through Hole Reflow - THR Soldering process: Wave or Reflow soldering
S	Assembly on PCB	Surface Mount Technology - SMT Soldering process: Reflow soldering
T	Assembly on PCB	Through Hole Technology - THT Soldering process: Wave
C5	Performance Category	Category 5
C6	Performance Category	Category 6
C6A	Performance Category	Category 6A
C5e	Performance Category	Category 5e
M	Performance Category	10/100 Mbit
G1	Performance Category	10/100/1000 Mbit
G10	Performance Category	10 Gbit
U	Performance Category	Unshielded
MP	Performance Category	10/100 Mbit with POE
MP+	Performance Category	10/100 Mbit with POE+

Recommended wave soldering profiles

Weidmüller Interface GmbH & Co. KG
 Klängenbergstraße 16
 D-32758 Detmold
 Germany
 Fon: +49 5231 14-0
 Fax: +49 5231 14-292083
 www.weidmueller.com

Single Wave:



Double Wave:



Wave soldering profiles

Wired connection elements should be processed in accordance with the DIN EN 61760-1 standard. We have included two recommendations for practical wave soldering profiles, with which Weidmüller PCB terminals and connectors are qualified.

When choosing a suitable profile for your application, the following factors also need to be considered:

- PCB thickness
- Proportion of Cu in the layers
- Single/double-sided assembly
- Product range
- Heating and cooling rates

The single and double wave profiles each indicate the recommended operating range, including the maximum soldering temperature of 260°C. In practice, the maximum soldering temperature is quite often well below the above maximum profile.

Recommended reflow soldering profile

Weidmüller Interface GmbH & Co. KG
 Klingenbergstraße 16
 D-32758 Detmold
 Germany
 Fon: +49 5231 14-0
 Fax: +49 5231 14-292083
 www.weidmueller.com



Reflow soldering profile

The perfect soldering profile for SMT Surface Mount Technology is one the most exiting question in SMT production. But there are more than one correct answer: The diagram of temperature-on-time is related to processing features of solder paste and to maximum load of components.

We have to consider the following parameters:

- Time for pre heating
- Maximum temperature
- Time above melting point
- Time for cooling
- Maximum heating rate
- Maximum cooling rate

We recommend a typical solder profile with associated process limits. With preheating components and board are prepared smoothly for the solder phase. Heating rate is typically $\leq +3\text{K/s}$. In parallel the solder paste is ‚activated‘. The time above melting point of 217°C the paste gets liquid and components and boards begin to connect. The maximum temperature of 245°C to 254°C should stay between 10 and 40 seconds. In the cooling phase at $\geq -6\text{K/s}$ solder is cured. Board and components cool down while avoiding cold cracks.