

# Industrial contactors

## 9 - 10 - 12 - 18 - 24 - 32 - 50 - 74 A



Power generators



Back-up generators



Industrial motors



Panels for electrical distribution



Pump control





**Mini industrial contactors**

**Type 6K.04.x.xxx.4x09**

- 9 A - 400 V AC3
- 4 kW - 400 V AC3

**Type 6K.04.x.xxx.4x12**

- 12 A - 400 V AC3
- 5.5 kW - 400 V AC3

- 3 NO contacts + 1 NC (2 A 400 V AC15)  
- Version 47xx
- 3 NO contacts + 1 NO (2 A 400 V AC15)  
- Version 48xx
- 4 NO contacts  
- Version 43xx
- According to EN 60947 / IEC 947
- Nominal voltage: 120 V AC, 230 V AC, 24 V AC or 24 V DC
- NC auxiliary contact in "mirror contact" configuration according to EN 60947-4-1
- Auxiliary block contact 2 A (AC15 - 400 V) in various configurations availables
- AgSnO<sub>2</sub> contacts
- 35 mm rail (EN 60715) mount

Screw terminal



\* Mirror contact configuration

For outline drawings see page 12

**NEW 6K.04.x.xxx.4x09**



• AgSnO<sub>2</sub> contacts

**NEW 6K.04.x.xxx.4x12**



• AgSnO<sub>2</sub> contacts

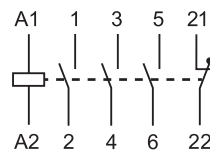

3 NO + 1 NC  
(47xx)

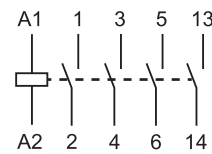

3 NO + 1 NO  
(48xx)

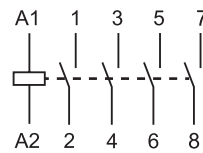

4 NO  
(43xx)

**Contact specification**

Contact configuration	3 NO + 1 NC* or 3 NO + 1 NO or 4 NO	
Rated current AC3	A	9                      12
Rated voltage	V AC	400                    400
Rated power AC3 @ 440 V	kW	4                        5.5
Rated power AC3 @ 690 V	kW	4                        5.5
Rated current AC1 @ 690 V	A	20                      20
Breaking capacity DC1: 24/110/220 V	A	20/5/0.6
Breaking capacity DC3: 24/110/220 V	A	20/1/0.15
Contact material	AgSnO <sub>2</sub>	

**Coil specification**

Nominal voltage (U <sub>N</sub> )	V AC (50/60 Hz)	24 - 110 - 230
	V DC	24
Rated power AC/DC	VA (50 Hz)/W	4/1.2
Operating range	V AC (50/60 Hz)	(0.85...1.1) U <sub>N</sub>
	V DC	(0.8...1.1) U <sub>N</sub>

**Technical data**

Mechanical life AC/DC	cycles	5 · 10 <sup>6</sup> / 15 · 10 <sup>6</sup>
Electrical life at rated load AC3	cycles	For electric life see page 9
Operate/release time	ms	15/8
Ambient temperature range	°C	-40...+70 (+90)**
Protection category		IP 20

**Approvals** (according to type)



\*\* with reduced voltage range (0.9...1.0) U<sub>N</sub>

A

**Industrial contactors**

**Type 6K.14.x.xxx.4x10**

- 10 A - 400 V AC3
- 4 kW

**Type 6K.14.x.xxx.4x18**

- 18 A - 400 V AC3
- 7.5 kW

- 3 NO contacts + 1 NC (2 A 400 V AC15)  
- Version 47xx
- 3 NO contacts + 1 NO (2 A 400 V AC15)  
- Version 48xx
- 4 NO contacts  
- Version 43xx
- According to EN 60947 / IEC
- Nominal voltage: 120 V AC, 230 V AC, 24 V AC
- NC auxiliary contact in "mirror contact" configuration according to EN 60947-4-1
- Auxiliary contact 1 NO or 1 NC 2A - 400 V AC15 available
- AgSnO<sub>2</sub> contacts
- 35 mm rail (EN 60715) mount

Screw terminal



**NEW 6K.14.x.xxx.4x10**



• AgSnO<sub>2</sub> contacts

**NEW 6K.14.x.xxx.4x18**



• AgSnO<sub>2</sub> contacts

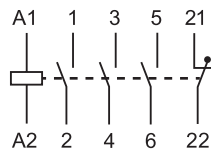

3 NO + 1 NC  
(47xx)

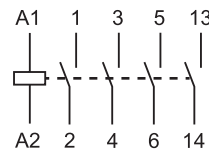

3 NO + 1 NO  
(48xx)

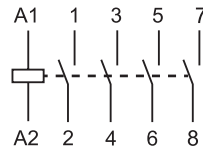

4 NO  
(43xx)

\* Mirror contact configuration  
For outline drawings see page 12

Contact specification			
Contact configuration		3 NO + 1 NC* or 3 NO + 1 NO or 4 NO	
Rated current AC3	A	10	18
Rated voltage	V	400	400
Rated power AC3 @ 400 V	kW	4	7.5
Rated power AC3 @ 690 V	kW	5.5	10
Rated current AC1 @ 690 V	A	25	32
Breaking capacity DC1: 24/110/220 V	A	20/6/0.8	32/6/0.8
Breaking capacity DC3: 24/110/220 V	A	20/1.2/0.2	32/1.2/0.2
Contact material		AgSnO <sub>2</sub>	AgSnO <sub>2</sub>
Coil specification			
Nominal voltage (U <sub>N</sub> )	V AC	24 - 110 - 230	
Rated power AC	VA (50 Hz)	7	
Operating range	V AC	(0.85...1.1) U <sub>N</sub>	
Technical data			
Mechanical life AC	cycles	10 · 10 <sup>6</sup>	
Electrical life at rated load AC3	cycles	For electric life see page 9	
Operate/release time	ms	10/8	
Ambient temperature range	°C	-40...+70 (+90)**	
Protection category		IP 20	
Approvals (according to type)			

\*\* with reduced voltage range (0.9...1.0) U<sub>N</sub>

**Industrial contactors**

**Type 6K.13.8.230.4324**

- 24 A - 400 V AC3
- 11 kW - 400 V AC3

**Type 6K.13.8.230.4332**

- 32 A - 400 V AC3
- 15 kW - 400 V AC3

- According to EN 60947 / IEC 947
- Nominal voltage: 120 V AC, 230 V AC, 24 V AC
- Auxiliary contact 1 NO or 1 NC 2A - 400 V AC15 available
- AgSnO<sub>2</sub> contacts
- 35 mm rail (EN 60715) mount

**NEW** 6K.13.8.xxx.4324



• AgSnO<sub>2</sub> contacts

**NEW** 6K.13.8.xxx.4332



• AgSnO<sub>2</sub> contacts

Screw terminal

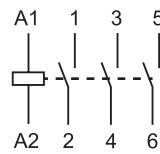

3 NO

For outline drawings see page 12

**Contact specification**

Contact configuration	3 NO	
Rated current AC3	A	24                      32
Rated voltage	V AC	400                      400
Rated power AC3 @ 400 V	kW	11                        15
Rated power AC3 @ 690 V	kW	15                        18.5
Rated current AC1 @ 690 V	A	50                        65
Breaking capacity DC1: 24/110/220 V	A	50/10/1.4              65/10/1.4
Breaking capacity DC3: 24/110/220 V	A	50/1.8/0.2             65/1.8/0.2
Contact material	AgSnO <sub>2</sub> AgSnO <sub>2</sub>	

**Coil specification**

Nominal voltage (U <sub>N</sub> )	V AC (50/60 Hz)	24 - 110 - 230
Rated power AC	VA (50 Hz)	9
Operating range	AC (50/60 Hz)	(0.85...1.1) U <sub>N</sub>

**Technical data**

Mechanical life AC	cycles	10 · 10 <sup>6</sup>
Electrical life at rated load AC3	cycles	For electric life see page 9
Operate/release time	ms	10/8
Ambient temperature range	°C	-40...+70 (+90)*
Protection category		IP 20

**Approvals** (according to type)



\* with reduced voltage range (0.9...1.0) U<sub>N</sub>

A

**Industrial contactors**

**Type 6K.13.8.xxx.4350**

- 50 A - 400 V AC3
- 22 kW - 400 V AC3

**Type 6K.13.8.xxx.4374**

- 74 A - 400 V AC3
- 37 kW - 400 V AC3

- According to EN 60947 / IEC 947
- Nominal voltage: 120 V AC, 230 V AC, 24 V AC
- Auxiliary contact 1 NO or 1 NC 2A - 400 V AC15 available
- AgSnO<sub>2</sub> contacts
- 35 mm rail (EN 60715) mount

**NEW** 6K.13.8.xxx.4350



• AgSnO<sub>2</sub> contacts

**NEW** 6K.13.8.xxx.4374



• AgSnO<sub>2</sub> contacts

Screw terminal

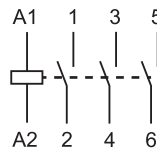

3 NO

For outline drawings see page 12

**Contact specification**

Contact configuration	3 NO		
Rated current AC3	A	50	74
Rated voltage	V	400	400
Rated power AC3 @ 400 V	kW	22	37
Rated power AC3 @ 690 V	kW	30	45
Rated current AC1 @ 690 V	A	110	130
Breaking capacity DC1: 24/110/220 V	A	110/12/1.4	130/12/1.4
Breaking capacity DC3: 24/110/220 V	A	110/1.8/0.25	130/1.8/0.25
Contact material	AgSnO <sub>2</sub>		AgSnO <sub>2</sub>

**Coil specification**

Nominal voltage (U <sub>N</sub> )	V AC	24 - 110 - 230	
Rated power AC	VA (50 Hz)	13	
Operating range	V AC	(0.85...1.1) U <sub>N</sub>	

**Technical data**

Mechanical life AC	cycles	10 · 10 <sup>6</sup>	
Electrical life at rated load AC3	cycles	For electric life see page 9	
Operate/release time	ms	12/8	
Ambient temperature range	°C	-40...+60 (+90)*	
Protection category		IP 20	

**Approvals** (according to type)



\* with reduced voltage range (0.9...1.0) U<sub>N</sub>

## Ordering information

Example: 6K series, industrial contactor, 3 contacts, 230 V AC, all NO contacts, 24 A AC3-400 V

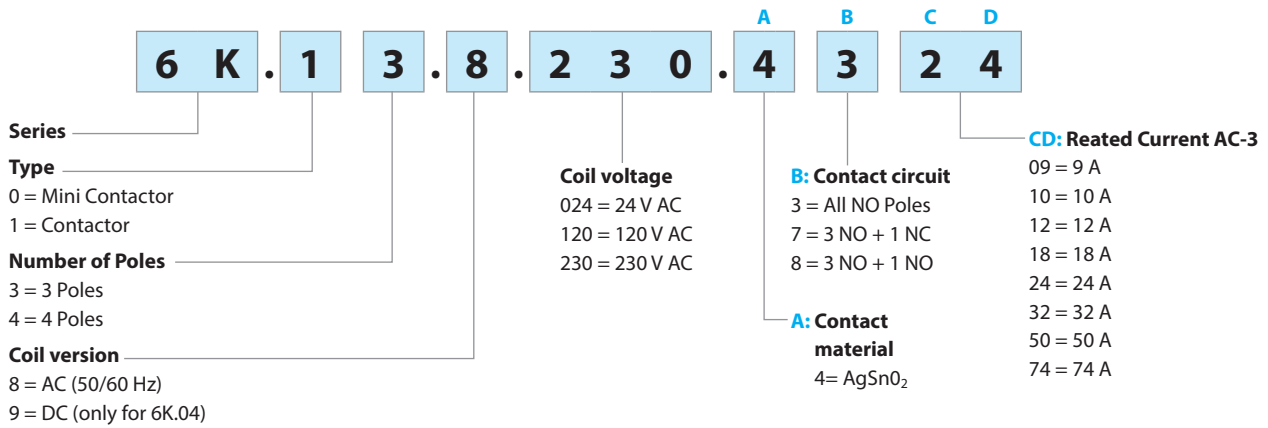

Selecting features and options: only combinations in the same row are possible.

Type	A	B	CD
6K.04	4	3 - 7 - 8	09 - 12
6K.14	4	3 - 7 - 8	10 - 18
6K.13	4	3	24 - 32 - 50 - 74

## Technical data

Short circuit protection		6K.04	6K.14	6K.13 - 4324/4332	6K.13 - 4350/4374	
Rated conditional short circuit current	kA	3	10	10	10	
Back-up fuse	A	40 (gL/gG type)	63	100	160	
Terminals	Solid and stranded cable					
		6K.04	6K.14	6K.13 - 4324/4332	6K.13 - 4350/4374	
Max. wire size	mm <sup>2</sup>	1 x 2.5	1 x 6	1 x 25	1 x 50	
	AWG	1 x 14	1 x 10	1 x 10	1 x 10	
Min. wire size	mm <sup>2</sup>	1 x 0.5	1 x 0.75	1 x 1.5	1 x 4	
	AWG	1 x 18	1 x 18	1 x 16	1 x 12	
Screw torque	Nm	0.8	0.8	2.5	3.5	
Wire strip length	mm	8	11	13	20	
Other data		6K.04	6K.14	6K.13 - 4324/4332	6K.13 - 4350	6K.13 - 4374
Shock resistance NO/NC	g	5/5	10/6	8/—	8/—	8/—
Power lost per pole AC3-400V	W	0.20	0.35	1.3	2.2	5.5

## Contact specification

Ratings and utilization categories according to EN 61095: 2009

Type	Utilization category					
	AC-4		AC-6a		AC-6b	
	Rated current $I_E$ @ 400V (A)	Rated power @440V (kW)	Rated current $I_E$ @ 400V (A)	Rated power @400V (kVA)	Rated current $I_E$ @ 500V (A)	Rated power @400V (kVA)
6K.04-4x09	9	4	—	—	—	—
6K.04-4x12	12	5.5	—	—	—	—
6K.14-4x10	10	4	4.5	3.1	8	5
6K.14-4x18	18	7.5	7.5	5.2	15.5	10
6K.13-4324	24	11	1.5	7.3	23	15
6K.13-4332	32	15	13.5	9.3	32	20
6K.13-4350	50	22	20	13.5	45	29
6K.13-4374	74	30	33	22.5	70	46

### Utilization categories

Kind of current	Utilization categories	Additional category designation	Typical load
AC	AC-1	General use	Non-inductive or slightly inductive loads
	AC-3		Squirrel-cage motors <sup>d</sup> : starting, switching off motors during running, reversing <sup>a</sup>
	AC-4		Squirrel-cage motors <sup>d</sup> : starting, plugging, inching
	AC-6a		Transformers
	AC-6b		Capacitor banks

### F 6K - Electrical life AC3 (kW) and AC1 (A) - Type 6K.04

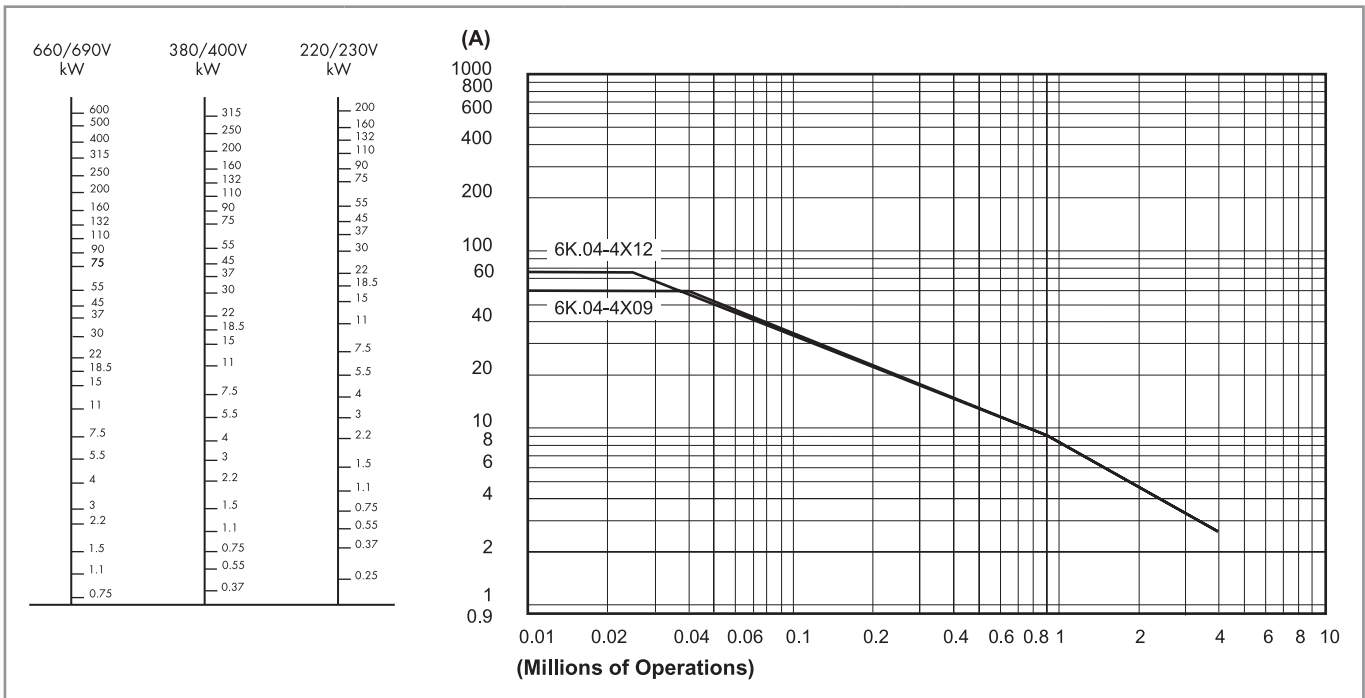



## Contact specification

### F 6K - Electrical life AC3 (kW) and AC1 (A) - Type 6K.13

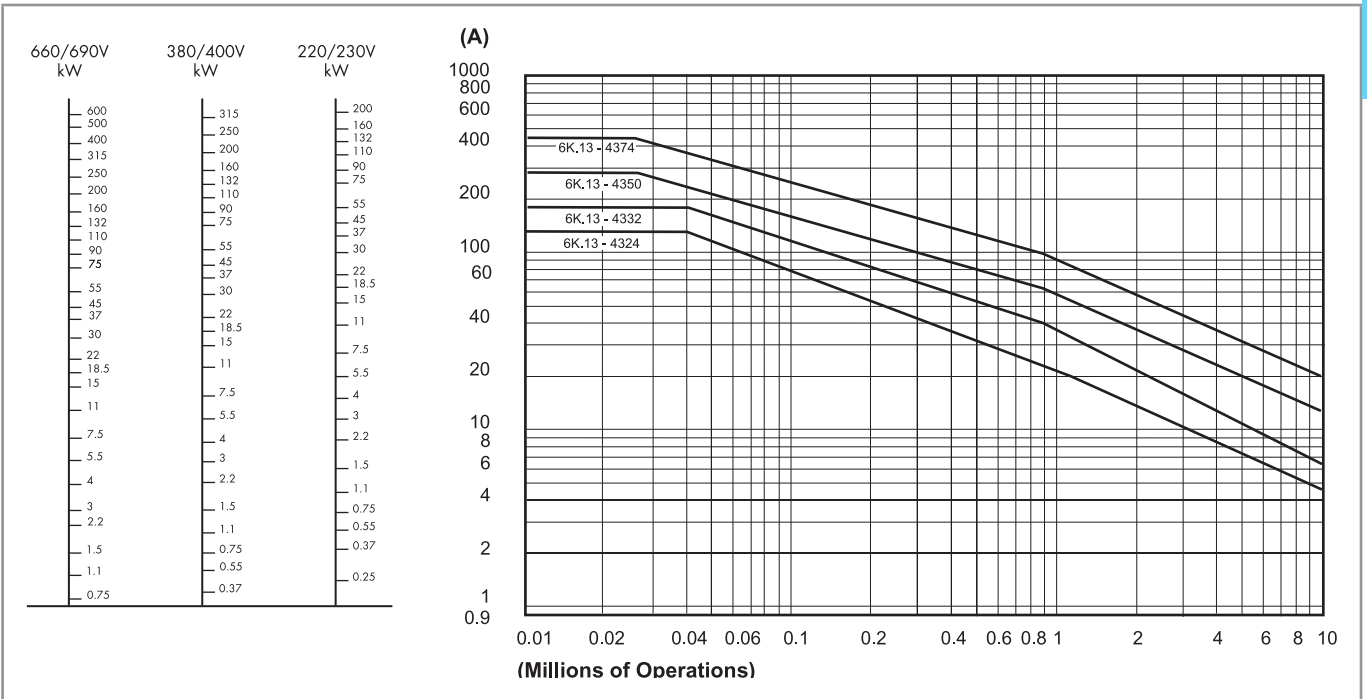

### F 6K - Electrical life AC3 (kW) and AC1 (A) - Type 6K.14

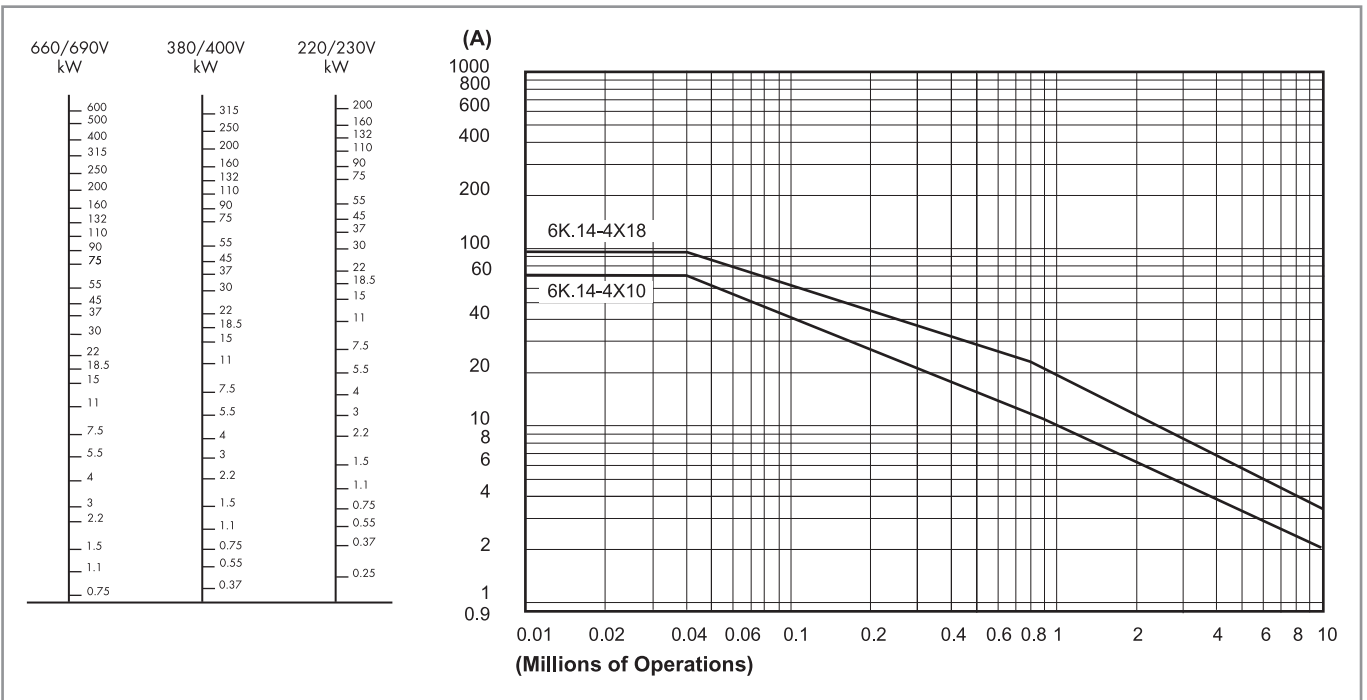

## Coil specifications

### AC version data (type 6K.04/14/13)

Nominal voltage $U_N$	Coil code	Operating range	
		$U_{min}$	$U_{max}$
V		V	V
24	<b>8.024</b>	20.4	26.4
110	<b>8.110</b>	93.5	132
230	<b>8.230</b>	187	253

### DC version data (type 6K.04)

Nominal voltage $U_N$	Coil code	Operating range	
		$U_{min}$	$U_{max}$
V		V	V
24	<b>9.024</b>	19.2	26.4

### Coil operating range v ambient temperature

Temperature	Operating range $U_N$
	Min...Max
70 °C	0.85...1.1
75 °C	0.86...1.08
80 °C	0.88...1.05
85 °C	0.89...1.02
90 °C	0.9...1.0

Wiring diagrams

A

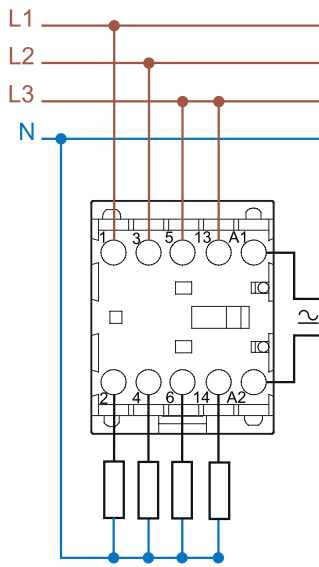

Type 6K.04-4x09/4x12

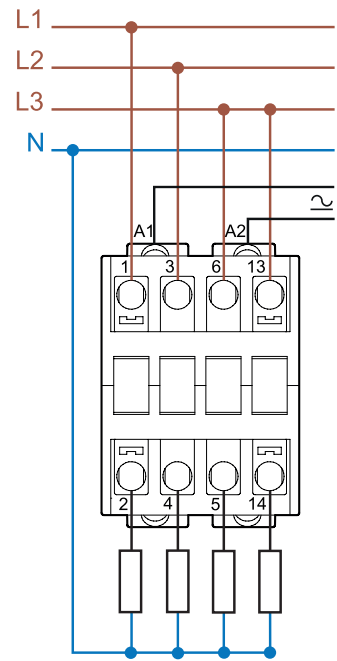

Type 6K.14-4x10/4x18

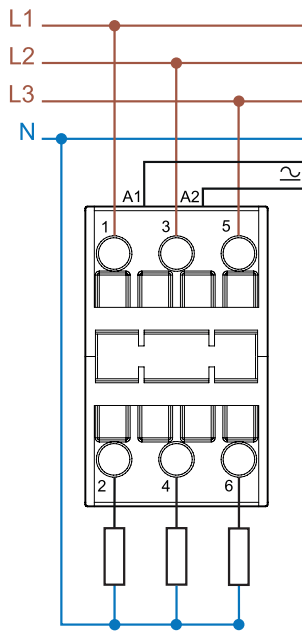

Type 6K.13-4324/4332

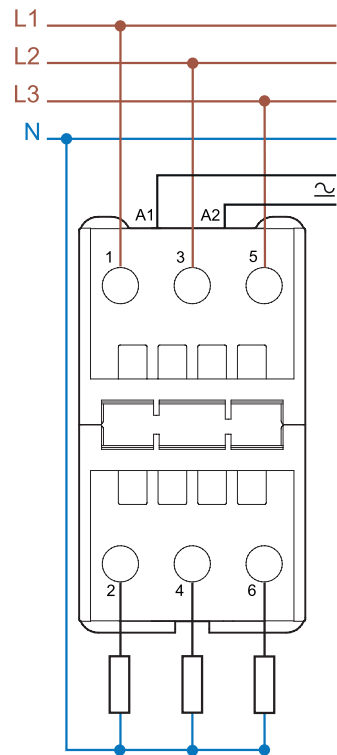

Type 6K.13-4350/4374

Outline drawings

A

Type 6K.04  
Screw terminal

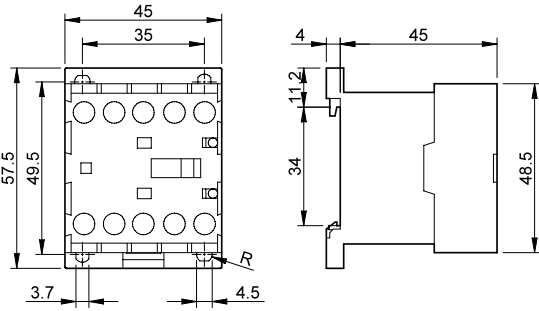

Type 6K.14  
Screw terminal

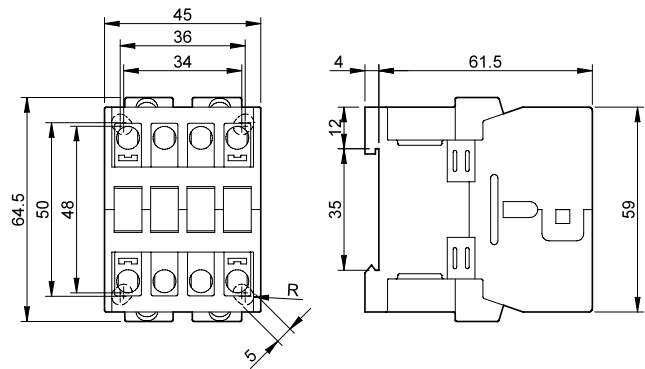

Type 6K.13-4324/4332  
Screw terminal

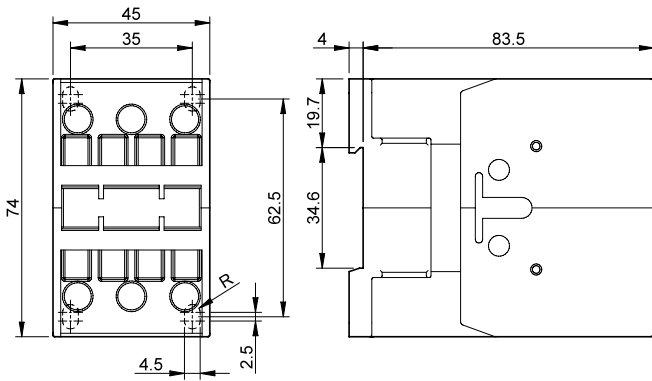

Type 6K.13-4350/4374  
Screw terminal

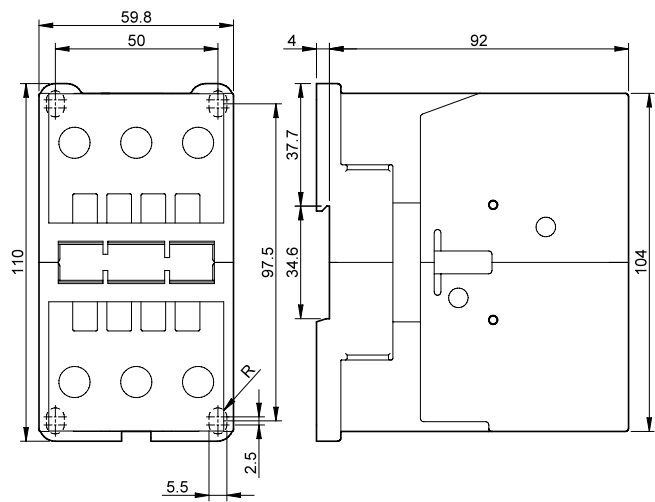

Type 06K.03/06

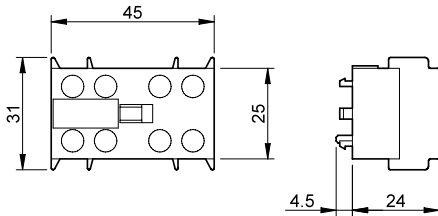

Type 06K11

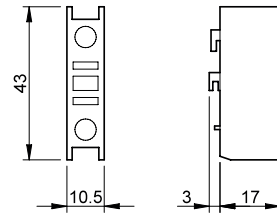



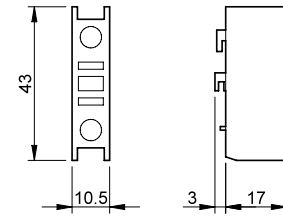



Type 06K12

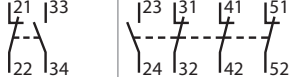

### Auxiliary modules

Mechanically linked contacts according to EN 60947-5-1, IEC 947-5-1

		06K.11	06K.12	06K.03 / 06K.06
				
				
Type of contactor		Type 6K.13 and 6K.14	Type 6K.13 and 6K.14	Type 6K.04
<b>Contact specification</b>				
Contact configuration (Bifurcated)		1 NO	1 NC	1 NO + 1 NC or 2 NO + 2 NC
Rated current @ 400 V AC15	A	2	2	2
Thermal rated current	A	10	10	10
Breaking capacity DC13: 24/110/220 V	A	2/0.4/0.1	2/0.4/0.1	2/0.4/0.1
Contact material		AgNi	AgNi	AgNi
<b>Short circuit protection</b>				
Max fuse size gL (gG)	A	20	20	20
<b>Terminals</b>				
Max. wire size	mm <sup>2</sup>	2.5	2.5	2.5
	AWG	12	12	14
Min. wire size	mm <sup>2</sup>	0.75	0.75	0.5
	AWG	14	14	18
 Screw torque	Nm	0.8	0.8	0.8
Wire strip length	mm	8	8	8
<b>Power lost to the environment</b>				
with rated current per pole @ AC1	W	0.5	0.5	1.2
<b>Approvals</b> (according to type)		