









## Ficha técnica

### Rueda TV-TN 2-0021

Codigo				Tipo cojinete Eje					
2-0021	125	350	45	—	139x110	110x84/98x66	10	164	115



#### Características

Fabricada con chapa de acero embutido hasta 5m/m de espesor.  
Acabado bicromatizado de alta resistencia al óxido.  
Doble rodamiento a bolas reforzado con pistas de rodadura endurecidas.  
Protector anti-polvo en el cojinete del soporte.  
Fabricadas según normas europeas en 12532.

#### Datos técnicos

**Diámetro:** 125 mm  
**Carga:** 350 kg  
**Tipo de cojinete:** Cojinete Liso  
**Ancho de Banda de rodadura:** 45 mm  
**Medidas de placa superior:** 139x110 mm  
**Distancia entre agujeros:** 110x84/98x66 mm  
**Diámetro agujero sujeción platina:** 10 mm  
**Altura total:** 164 mm  
**Radio de giro:** 115 mm

#### Archivos CAD

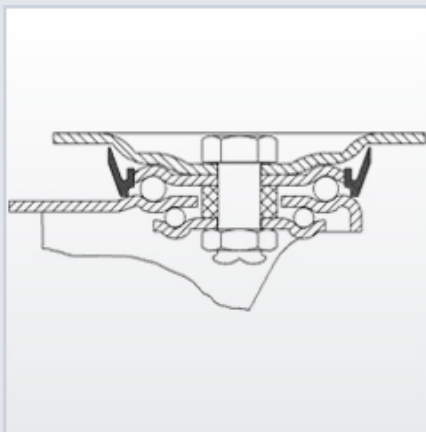

#### Rueda

**TN (Nylon)**  
Rueda de nylon extrafuerte  
**Rango de temperatura:** -30° ÷ +80°

#### Productos relacionados

