

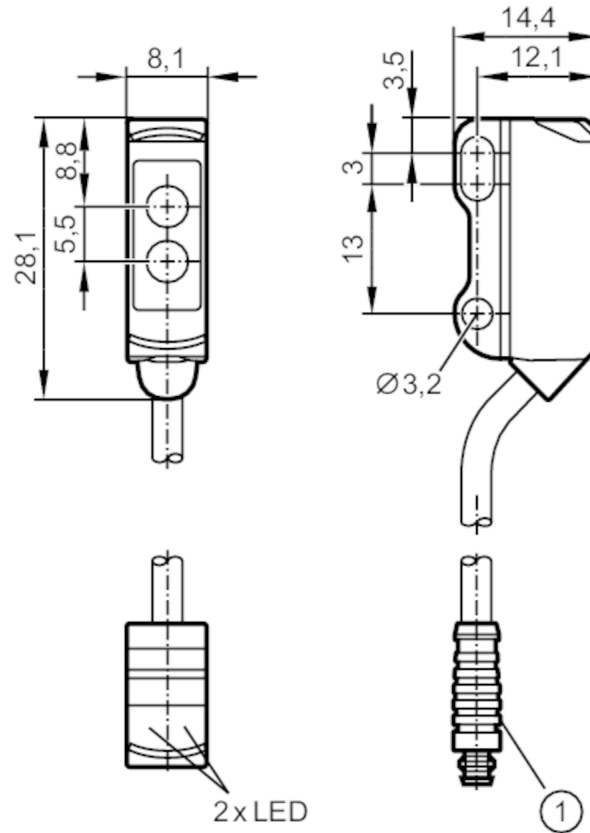

Diffuse reflection sensor with background suppression

O8H-HNKG/0,30M/AS/3P



1: illustration (example)
receiver in upper lens
transmitter in lower lens



Product characteristics

Type of light	red light
Housing	rectangular
Dimensions [mm]	28.1 x 8.1 x 14.4

Application

Special feature	Background suppression
Function principle	Diffuse reflection sensor

Electrical data

Operating voltage [V]	10...30 DC
Current consumption [mA]	20; ((24 V))
Protection class	III
Reverse polarity protection	yes
Type of light	red light
Wave length [nm]	633

O8H221



Diffuse reflection sensor with background suppression

O8H-HNKG/0,30M/AS/3P

Outputs		
Electrical design		NPN
Output function		light-on mode
Max. voltage drop switching output DC	[V]	2.5
Permanent current rating of switching output DC	[mA]	100
Switching frequency DC	[Hz]	1000
Short-circuit protection		yes
Type of short-circuit protection		pulsed
Detection zone		
Range	[mm]	1...80; (white paper 200 x 200 mm)
Range on white object (90 % remission)	[mm]	1...80
Range on grey object (18 % remission)	[mm]	3...76
Range on black object (6 % remission)	[mm]	5...74
Range adjustable		no
Max. light spot diameter	[mm]	4
Light spot dimensions refer to		at maximum range
Background suppression available		yes
Operating conditions		
Ambient temperature	[°C]	-25...60
Protection		IP 65; IP 67
Tests / approvals		
EMC		EN 60947-5-2
MTTF	[years]	757
Mechanical data		
Weight	[g]	22.7
Housing		rectangular
Dimensions	[mm]	28.1 x 8.1 x 14.4
Materials		housing: ABS; stainless steel (1.4404 / 316L)
Lens material		PMMA
Lens alignment		side lens
Displays / operating elements		
Display	switching status	1 x LED, yellow
	operation	1 x LED, green
Remarks		
Pack quantity		1 pcs.
Electrical connection		
Cable: 0.3 m, PVC; 3 x 0.08 mm ²		
Connector: 1 x M8		

Diffuse reflection sensor with background suppression

O8H-HNKG/0,30M/AS/3P



Connection

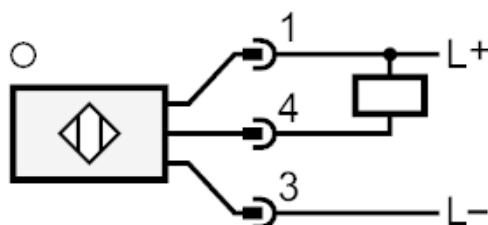

Diagrams and graphs

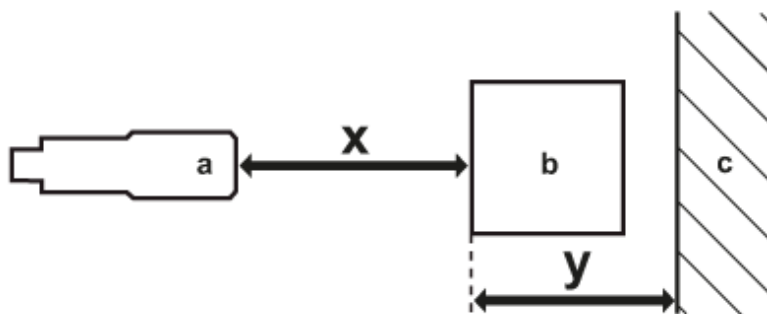

- a: sensor
- b: object
- c: background
- x: distance sensor/object [mm]
- y: min. distance object/background [mm]



Diffuse reflection sensor with background suppression

O8H-HNKG/0,30M/AS/3P

accuracy graph

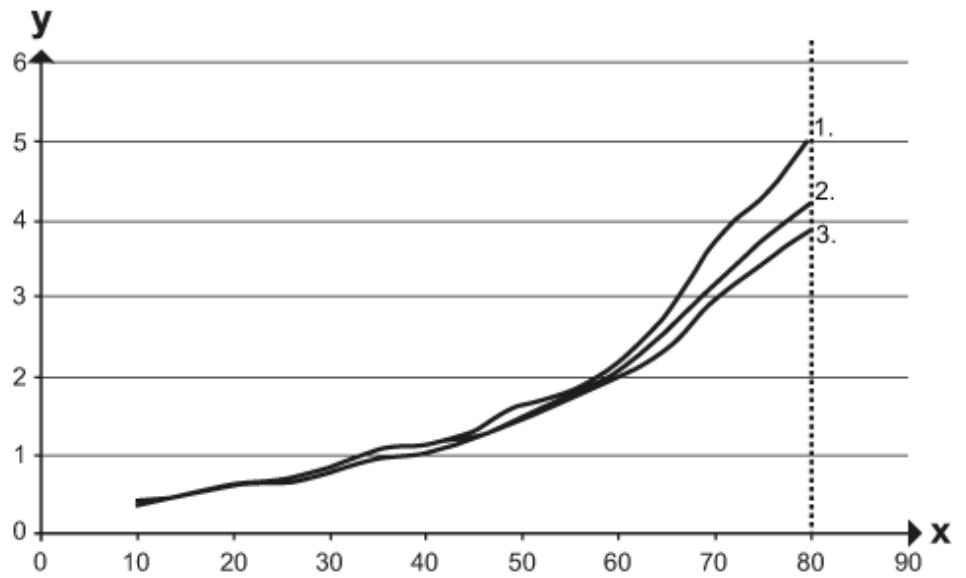

x: distance sensor/object [mm]

y: min. distance object/background [mm]

1 = object black (6 % remission) , background (white 90 % remission)

2 = object grey (18 % remission) , background (white 90 % remission)

3 = object white (90 % remission) , background (white 90 % remission)