

OY828S

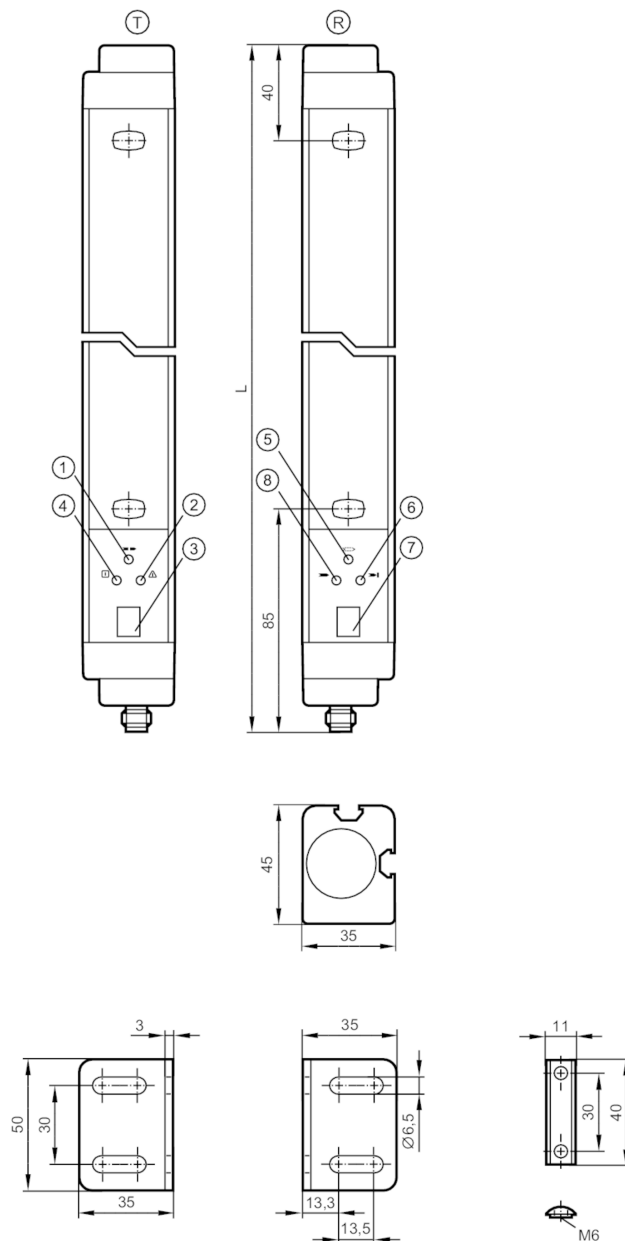

Safety light curtain

OYA1060-40-4-18-P-1-B



- T transmitter
- R receiver
- 1 LED yellow
- 2 LED red
- 3 7-segment LED display
- 4 LED green
- 5 LED yellow
- 6 LED red
- 7 7-segment LCD display
- 8 LED green



Product characteristics

Type of light	infrared light
Dimensions [mm]	1161 x 35 x 45



Safety light curtain

OYA1060-40-4-18-P-1-B

Application		
Protective function		access prevention hand protection
Electrical data		
Operating voltage tolerance	[%]	20
Operating voltage	[V]	24 DC
Protection class		III
Reverse polarity protection		yes
Power-on delay time	[s]	< 18
Type of light		infrared light
Wave length	[nm]	950
Receiver		
Current consumption	[mA]	125
Transmitter		
Current consumption	[mA]	83
Outputs		
Electrical design		PNP
Number of OSSD outputs		2
Max. current load per OSSD output	[mA]	500; (24 V)
Short-circuit protection		yes
Detection zone		
Protected area height	[mm]	1060
Resolution (detection capacity d)	[mm]	40
Protection area width (low light intensity)	[m]	0...6
Protection area width (high light intensity)	[m]	3...18
Floating blanking		yes
Response times		
Response time	[ms]	11.5
Operating conditions		
Applications		class C to EN 60654-1 weatherproof application
Ambient temperature	[°C]	0...55
Max. relative air humidity	[%]	95
Protection		IP 65
Tests / approvals		
EMC		IEC 61496-1
Shock resistance		IEC 61496-1
Vibration resistance		IEC 61496-1



Safety light curtain

OYA1060-40-4-18-P-1-B

Safety classification

ESPE type (IEC 61496-1)	4
ISO 13849-1	category 4, PL e
IEC 61508	SIL 3
IEC 62061	SIL cl 3
Mission time TM [h]	175200
Safety-related reliability PFHD [1/h]	1.4 E -08

Mechanical data

Weight [g]	5837
Dimensions [mm]	1161 x 35 x 45
Materials	housing: aluminium; front lens: PC
Length L [mm]	1161

Displays / operating elements

Display	transmitter	3 x LED
	transmitter	7-segment LCD display
	receiver	3 x LED
	receiver	7-segment LCD display

Accessories

Accessories (supplied)	mounting bracket: 4
	slot nuts: 4
	screws

Remarks

Notes	For 8-pole sockets the core colours are not standardised.; Please note the wiring of the sensor and the sockets (see data sheet).
Pack quantity	1 pcs.

Electrical connection - receiver

Connector: 1 x M12; Maximum cable length: 100 m; for wire cross-section 0.34 mm²

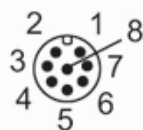

OY828S



Safety light curtain

OYA1060-40-4-18-P-1-B

Connection

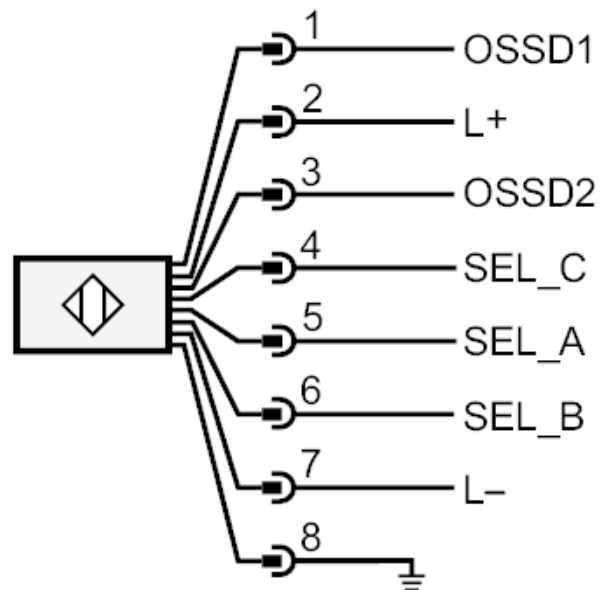

Electrical connection - transmitter

Connector: 1 x M12



OY828S



Safety light curtain

OYA1060-40-4-18-P-1-B

Connection

