

# New Generation DPDT Subminiature Signal Relay UC2/UD2

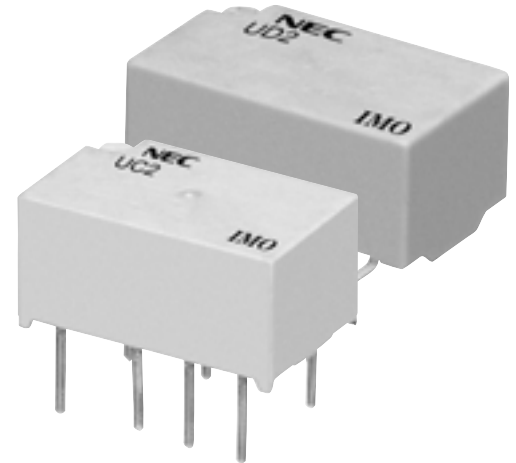

- Compact and light weight
- 2 Form C Contact arrangement
- Low power consumption (140mW)
- UL Recognised, CSA Certified
- Tube or taped packaging
- Super high density mounted
- Meets Bell-Core standard requirements
- Meets IEC950/UL1950/EN60950 insulation distance



## Options and ordering codes

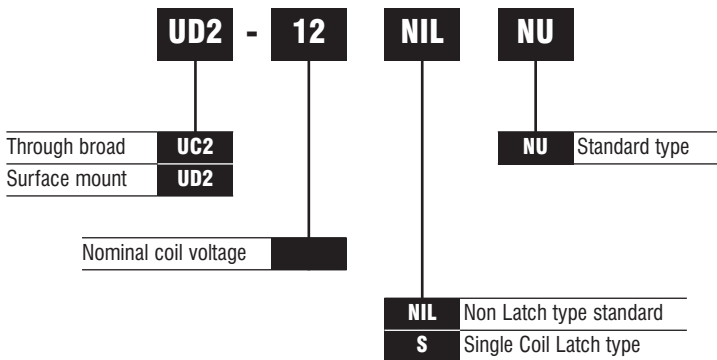

## Contact Data

Contact form	2 Form C
Contact rating	
Max. switching power	30W/37.5VA
Max. switching voltage	220Vdc/250Vac
Max. switching current	1A
Max. carrying current	1A
Initial contact resistance	Maximum 100mΩ (initial)
Contact material	Silver alloy with gold overlay
Nominal operating power	
Non-latch type	140mW (230mW for 24V)
Single coil latch type	100mW (120mW for 24V)
Running specifications	
Nonload	5x10 <sup>7</sup> ops 1x10 <sup>7</sup> ops for latching types
Load	1x10 <sup>6</sup> (30VDC-1A resistive) 1x10 <sup>6</sup> (125VAC-0.3A resistive)

## Characteristics

Operate time (excluding bounce)	Approx. 4ms without diode	
Release time (excluding bounce)	Approx. 4ms without diode	
Insulation resistance	1000MΩ at 500 VDC	
Breakdown voltage	Between open contact	1000VAC 1min (1500V surge, 10x160μs FCC Part 68)
	Between adjacent contacts	1000VAC 1min (1500V surge, 10x160μs FCC Part 68)
	Between coil to contacts	1500VAC 1min, 2500V surge (2x10μs Bell-Core)
Shock resistance	735mm/s <sup>2</sup>	
Vibration resistance	10-55Hz, double amplitude 3.3mm	
Ambient temperature	-40 to 85°C	
Weight	Approx. 1 gram	

# New Generation DPDT Subminiature Signal Relay UC2/UD2



## Coil Data

Non-latch type

20 °C

Part Number	Nominal Coil Voltage VDC	Coil Resistance $\Omega \pm 10\%$	Operate Voltage (VDC)	Release Voltage (VDC)	Nominal operate power
UC2-1.5NU/UD2-1.5NU	1.5	16	75% of nominal voltage	10% of nominal voltage	140mW
UC2-3NU/UD2-3NU	3	64.3			140mW
UC2-4.5NU/UD2-4.5NU	4.5	145			140mW
UC2-5NU/UD2-5NU	5	178			140mW
UC2-6NU/UD2-6NU	6	257			140mW
UC2-9NU/UD2-9NU	9	579			140mW
UC2-12NU/UD2-12NU	12	1028			140mW
UC2-24NU/UD2-24NU	24	2504			230mW

Single coil latch type

20 °C

Part Number	Nominal Coil Voltage VDC	Coil Resistance $\Omega \pm 10\%$	Operate Voltage (VDC)	Release Voltage (VDC)	Nominal operate power
UC2-1.5SNU/UD2-1.5SNU	1.5	22.5	75% of nominal voltage	10% of nominal voltage	100mW
UC2-3SNU/UD2-3SNU	3	90			100mW
UC2-4.5SNU/UD2-4.5SNU	4.5	202.5			100mW
UC2-5SNU/UD2-5SNU	5	250			100mW
UC2-6SNU/UD2-6SNU	6	360			100mW
UC2-9SNU/UD2-9SNU	9	810			100mW
UC2-12SNU/UD2-12SNU	12	1440			100mW
UC2-24SNU/UD2-24SNU	24	4800			120mW

## Outline dimensions (mm)

Wiring diagram and PC Board layout

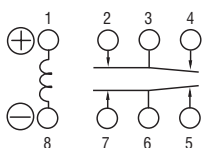
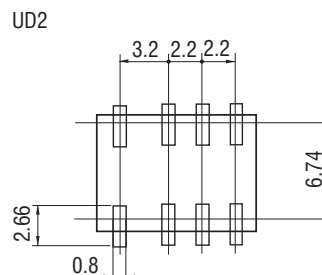
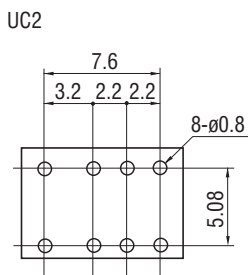
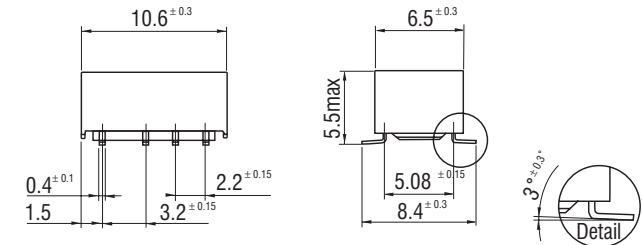
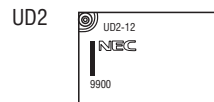
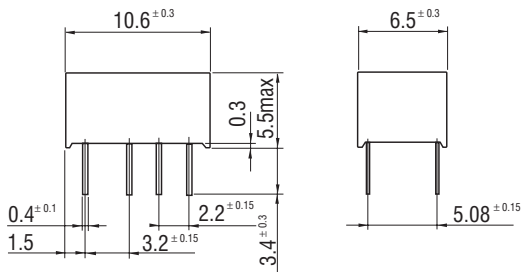
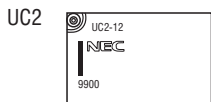

Non-latch type  
(Not energised position)

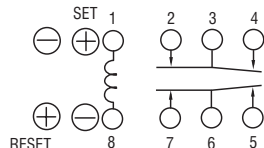

Single coil latch type  
(reset position)