

IT - RICEVITORE RADIO PER IL CONTROLLO DI STRIP LED 1-COLORE ANODO COMUNE

Permette di controllare le 3 uscite in modo indipendente o sincronizzato.

EN - RADIO RECEIVER CONTROLLING 1-COLOUR LED STRIPS COMMON ANODE

Independent or synchronized control of the 3 output.

FR - RECEPTEUR RADIO POUR LE CONTROLE DES LEDS MONOCHROME AVEC ANODE COMMUNE

Possibilité de commander les 3 sorties séparément ou simultanément.

DE - EMPFÄNGER ZUR ANSTEUERUNG VON EINFARBIGEN LED STRIPES – GEMEINSAME ANODE

Es ist möglich die Ausgänge entweder auf unabhängige oder synchronisierte Weise anzusteuern.

IT - Codice prodotto

EN - Product code

FR - Code du produit

DE - Artikelnummer

TVSTRD868SI24G Master 3x4A (868.3Mhz)

TVSTRD916SI24G Master 3x4A (916Mhz)

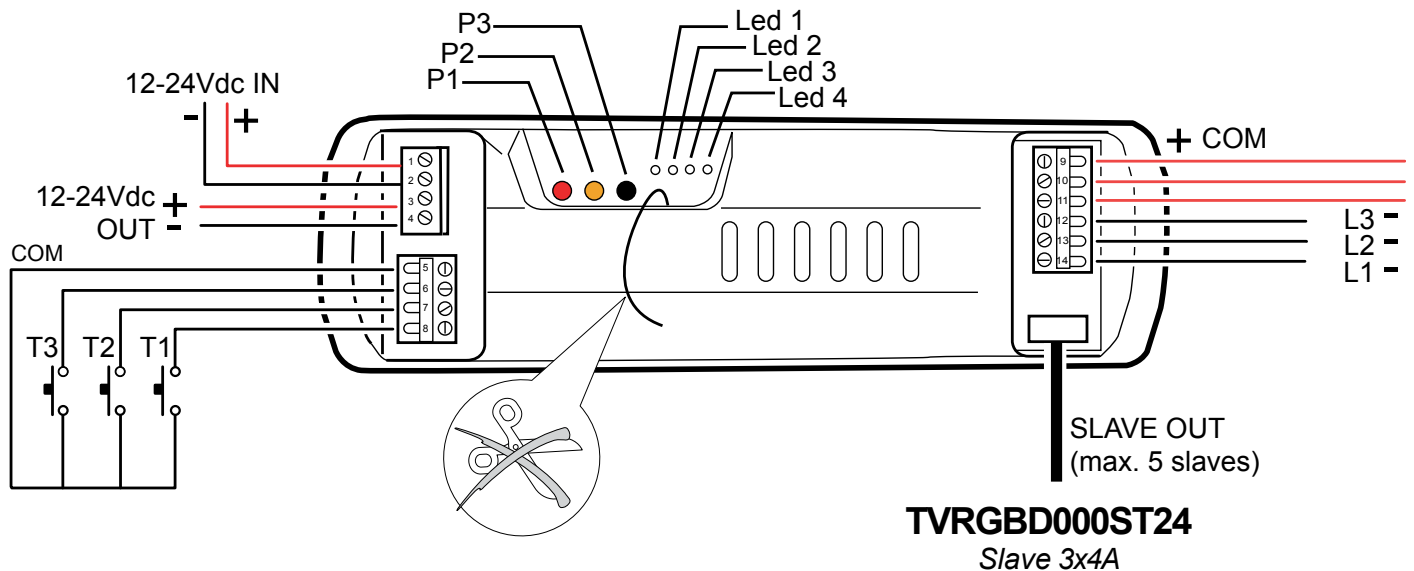

IT - Montaggio EN - Mounting FR - Fixation DE - Montage

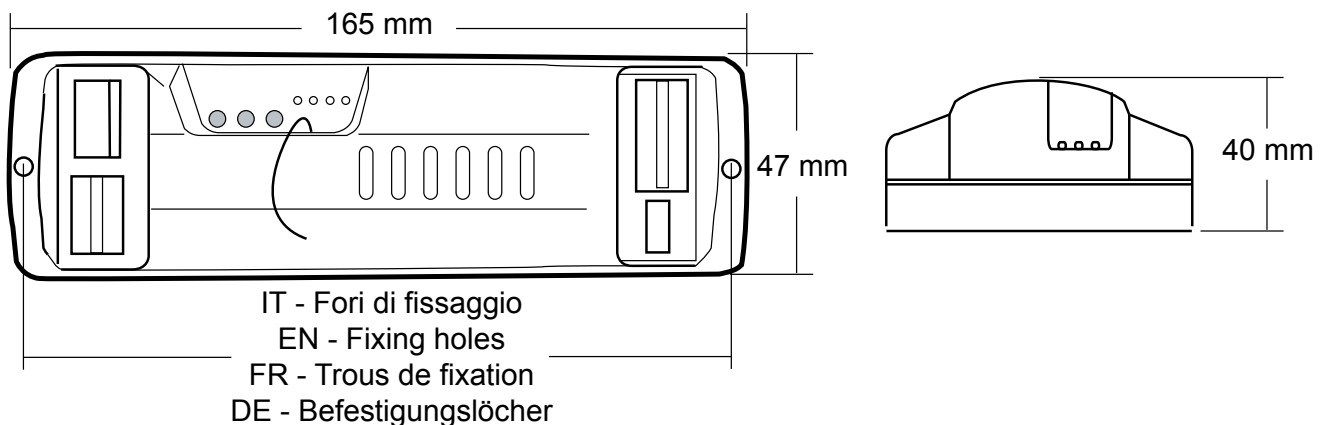

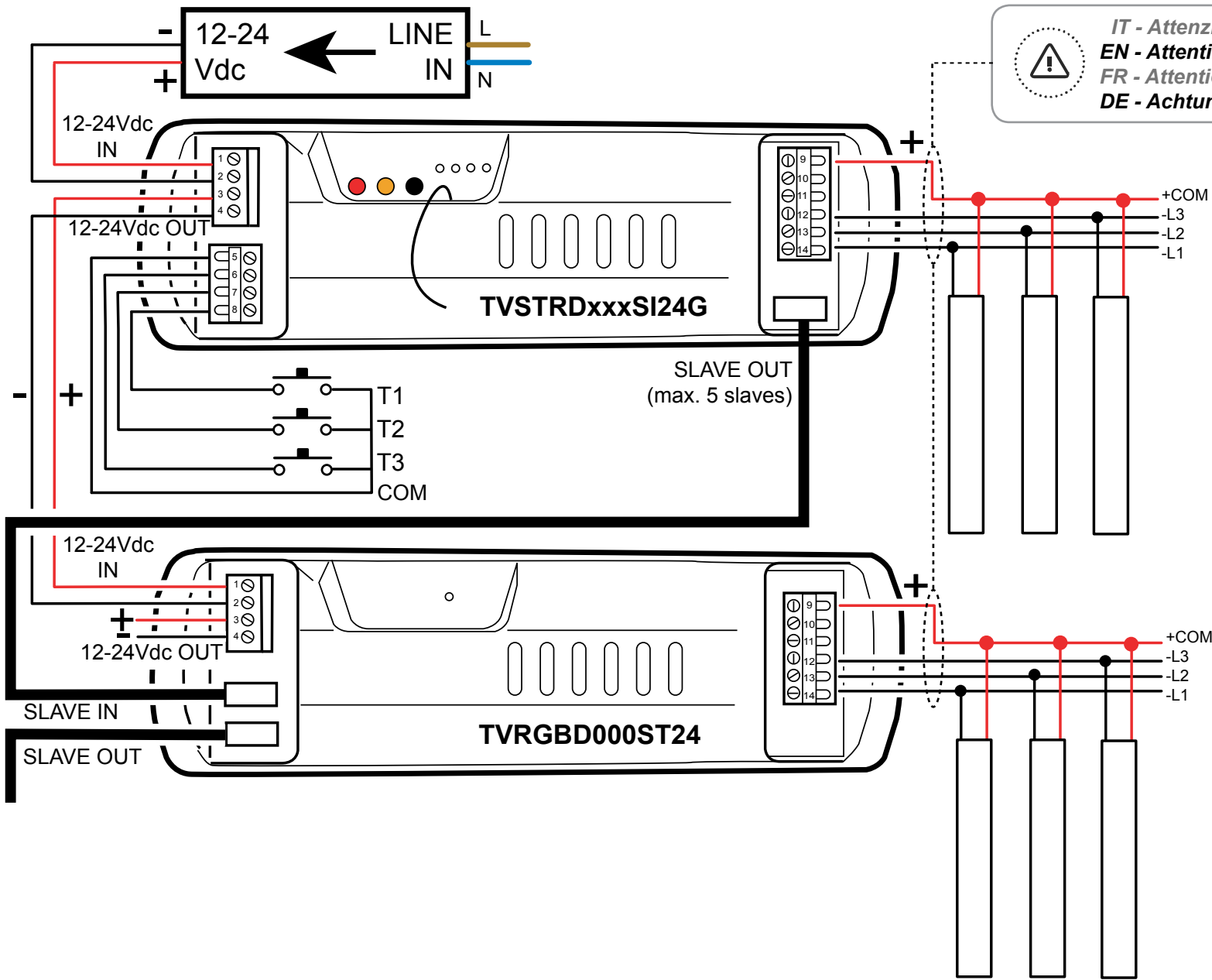

IT - Attenzione: non invertire la polarità dei led!
EN - Attention: do not invert the polarity of the led!
FR - Attention: ne pas inverser la polarité des leds!
DE - Achtung: Polung der LEDs nicht invertieren!

IT - Attenzione: l'alimentazione fornita al ricevitore deve corrispondere al voltaggio del carico!
EN - Attention: the power supply connected to the receiver must correspond to the voltage of the load!
FR - Attention: l'alimentation fournie au récepteur doit correspondre à la tension de la charge!
DE - Achtung: Die Stromversorgung des Empfängers muss mit der Spannung der Last übereinstimmen!

IT - Dispositivi di comando EN - Command devices FR - Dispositifs de commande DE - Steuerungsgeräte

IT - Ingressi filari EN - Wired input FR - Entrées filaires DE - Verdrahtete Eingänge

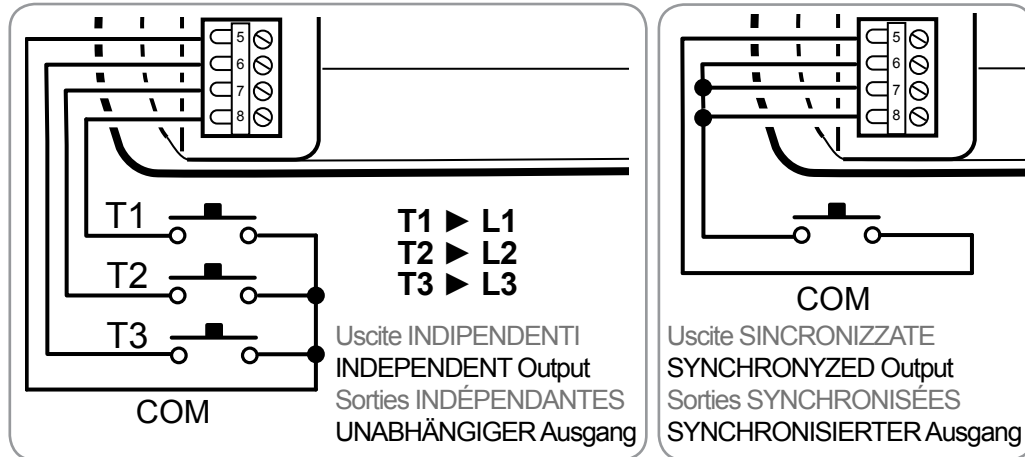

IT - T1, T2, T3 / (T1+T2+T3)
Breve pressione = ON/OFF
Premuto = Dimmer

EN - T1, T2, T3 / (T1+T2+T3)
Short press = ON/OFF
Keep pressed = Dimmer

FR - T1, T2, T3 / (T1+T2+T3)
Pression courte = ON/OFF
Continue = Dimmer

DE - T1, T2, T3 / (T1+T2+T3)
Kurzer Druck = EIN/AUS
Gedrückt halten = Dimmer

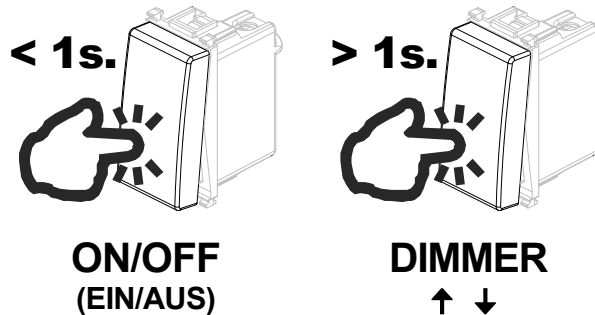

IT - Comando wireless EN - Wireless command FR - Commande sans fil DE - Drahtlose Steuerung

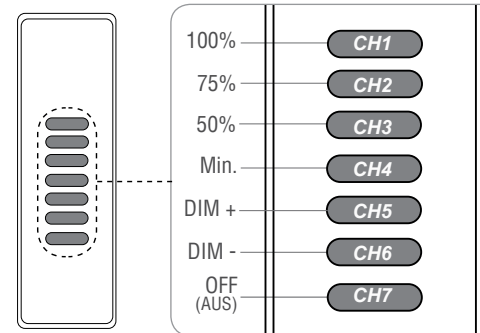

IT - Trasmettitore 7 canali EN - 7 channels transmitter FR - Emetteur à 7 canaux DE - 7-Kanal Sender

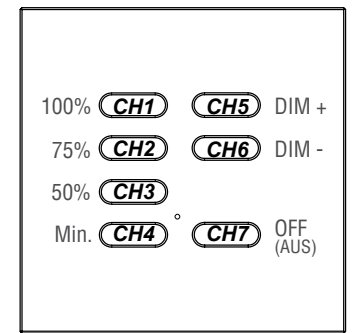

IT - Trasmettitore 7 canali EN - 7 channels transmitter FR - Emetteur à 7 canaux DE - 7-Kanal Sender

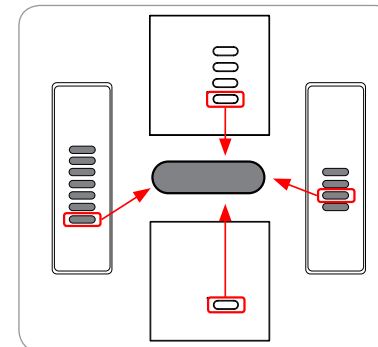

IT - Canale singolo di comando EN - Single command channel FR - Canal individuel de commande DE - Einzel- Kanal für Befehle

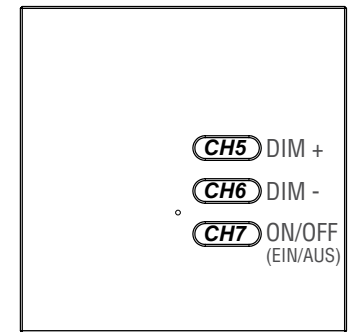

IT - Trasmettitore 3 canali EN - 3 channels transmitter FR - Emetteur à 3 canaux DE - 3-Kanal Sender

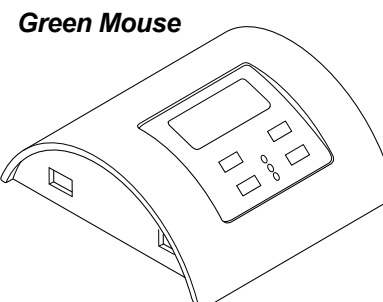

IT - Trasmettitore con sensore luce integrato
i Vedere le istruzioni del prodotto per dettagli.

EN - Transmitter with integrated light sensor
i See the product's instructions for details.

FR - Emetteur avec capteur de lumière intégré
i Voir la notice du produit pour plus d'informations.

DE - Sender mit integriertem Lichtsensor
i Siehe Anleitung des Produkts für Details.



**Attenzione
Attention
Achtung**

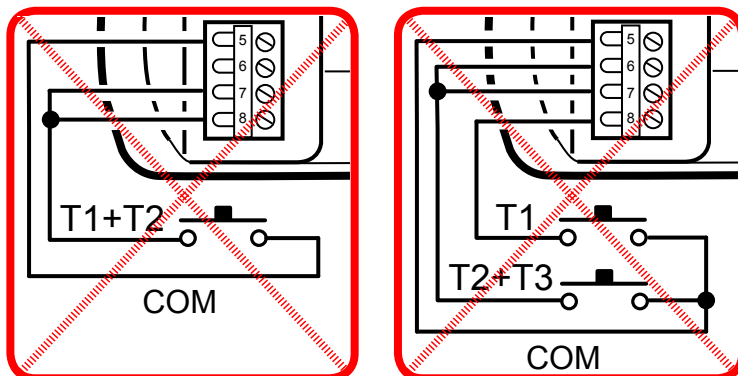

1.1

IT - Selezione delle uscite (L1, L2, L3) per la memorizzazione dei codici radio

EN - Output selection (L1, L2, L3) for the radio codes memorization

FR - Sélection des sorties (L1, L2, L3) pour la mémorisation des codes radio

DE - Auswahl einzelner Ausgänge (L1, L2, L3) für Einlernung Sendekanäle

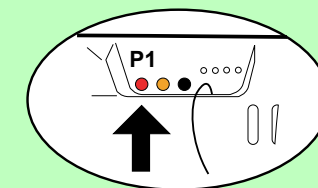

IT - Prima della memorizzazione di qualsiasi codice radio è necessario selezionare l'uscita alla quale verrà associato. Se non viene eseguita questa procedura il nuovo codice radio comanderà tutte le uscite contemporaneamente. **ATTENZIONE:** una volta selezionata l'uscita, la memorizzazione del codice radio deve essere effettuata entro **15 secondi** (vedere pagina 5). In caso di time-out il ricevitore emette un bip ed esce dalla procedura. **EN - Before memorizing any radio code it is necessary to select the output which it will be associated to. By default, in case of no output selection, the new radio code will command all the outputs at the same time. ATTENTION:** once the output is selected, the memorization of the radio code must be carried out within **15 seconds** (see page 5). In case of time-out the receiver beeps and exits the procedure. **FR - Avant de mémoriser n'importe quel code radio, il est nécessaire de sélectionner la sortie à laquelle il sera associé. Si cette procédure n'est pas suivie, le nouveau code radio commandera toutes les sorties simultanément. ATTENTION :** Quand la sortie a été sélectionnée, la mémorisation du code radio doit être effectuée dans les **15 secondes** (voir page 5). Si le temps a été dépassé, le récepteur émettra un bip et sortira de la procédure. **DE - Vor dem Einspeichern eines beliebigen Sendekanals muss der gewünschte Ausgang festgelegt werden, ansonsten werden alle Ausgänge gemeinsam angesteuert. ACHTUNG:** Nach Auswahl des Ausgangs haben Sie **15 Sekunden** Zeit um den Sendekanal einzulernen (siehe S. 5). Wird während dieser **15 Sekunden** kein Einlernvorgang durchgeführt bricht der Empfänger mit einem Piep ab und beendet den Vorgang.

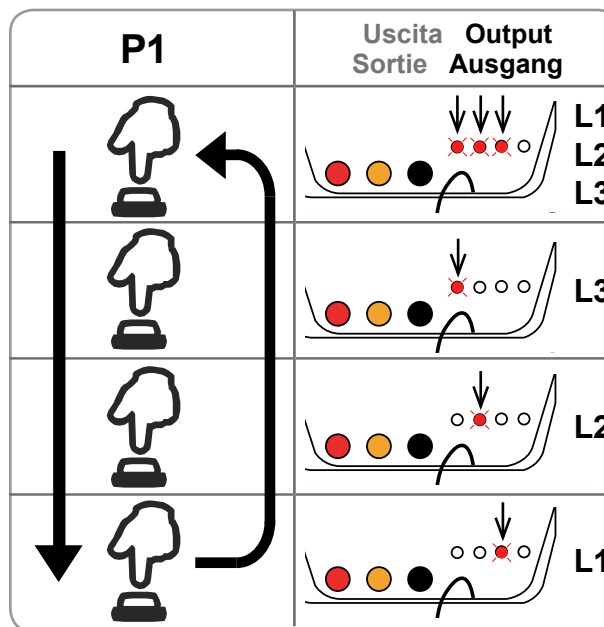
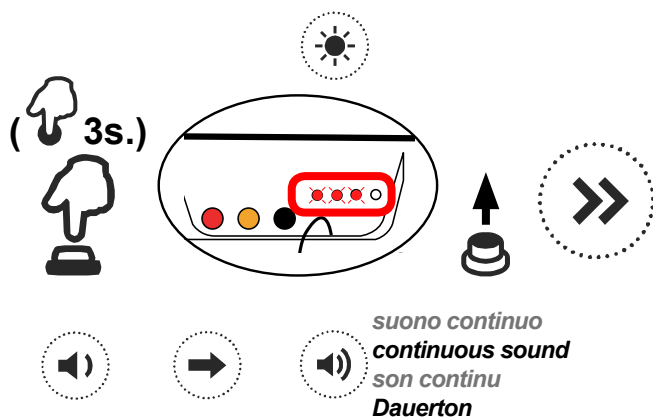

IT - VEDERE PAG. 5

EN - SEE PAGE 5

FR - VOIR PAGE 5

DE - SIEHE SEITE 5

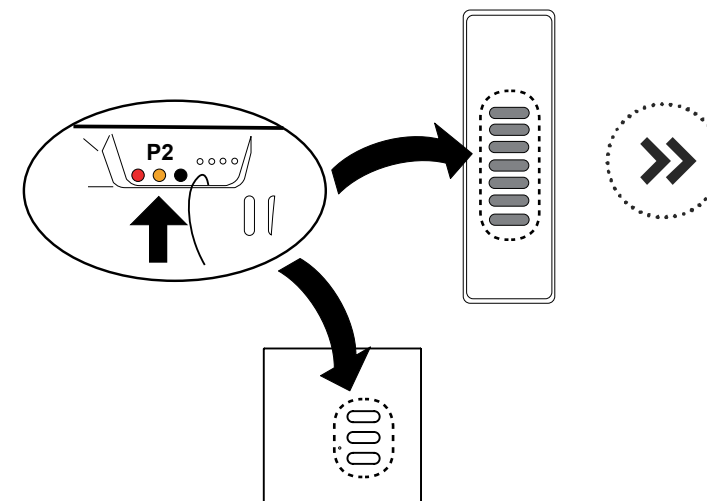







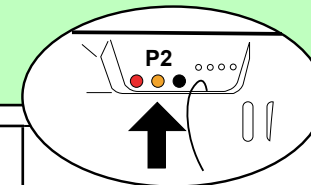



















IT - Premere **P1** e tenere premuto per **3s.**,
 EN - Press **P1** and keep it pressed for **3s.**,
 FR - Appuyer sur **P1** et le maintenir appuyé pendant **3s.**,
 DE - **P1** Drücken und **3S.** lang gedrückt halten,

premere **P1** per selezionare l'uscita,
 press **P1** to select the output,
 appuyer sur **P1** pour sélectionner la sortie,
P1 Drücken um Ausgang auszuwählen,





memorizzare il codice radio entro **15s.**
 memorize the radio code within **15s.**
 mémoriser le code radio dans les **15s.**
 lernen Sie innerhalb von **15S.** den Sendekanal ein.

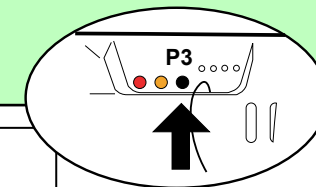

<p>IT - TIPO DI MEMORIZZAZIONE (vedere descrizione p.3)</p> <p>EN - TYPE OF MEMORIZATION (see description p.3)</p> <p>FR - TYPE DE MÉMORISATION (voir description p.3)</p> <p>DE - EINLERNUNGSART (siehe Beschreibung S.3)</p>	<p>P2</p>	<p> tenere premuto keep it pressed maintenir appuyé gedrückt halten</p>	<p> suono continuo continuous sound son continu Dauer-ton</p>
<p>IT - 7 canali EN - 7 channels FR - 7 canaux DE - 7 Kanäle</p>	<p>* x1</p>	<p> → </p>	
<p>IT - 1 tasto: EN - 1 button: FR - 1 bouton: DE - 1 Taste:</p> <p> < 1s.  > 1s.</p> <p>ON/OFF (EIN/AUS) DIMMER ↑ ↓</p>	<p>* x2</p>	<p> → </p>	<p>IT - Premere il tasto del trasmettitore relativo al codice da memorizzare.</p>
<p>IT - 1 tasto con funzione ON EN - 1 button with function ON FR - 1 bouton avec fonction ON DE - 1 Taste mit Funktion EIN</p>	<p>* x3</p>	<p> →  → </p>	<p>EN - Press the button of the transmitter relative to the code to memorize.</p>
<p>IT - 1 tasto con funzione OFF EN - 1 button with function OFF FR - 1 bouton avec fonction OFF DE - 1 Taste mit Funktion AUS</p>	<p>* x4</p>	<p> →  →  → </p>	<p>FR - Appuyer sur le bouton de l'émetteur concernant le code à mémoriser.</p> <p>DE - Drücken Sie die Sendertaste die auf den zu speichernden Code bezogen ist.</p>
<p>IT - 3 canali EN - 3 channels FR - 3 canaux DE - 3 Kanäle</p>	<p>* x5</p>	<p> →  →  →  → </p>	
<p>IT - Green Mouse EN - Green Mouse FR - Green Mouse DE - Green Mouse</p>	<p>* x6</p>	<p> →  →  →  →  → </p>	





<p>IT - TIPO DI CANCELLAZIONE EN - TYPE OF DELETION FR - TYPE DE SUPPRESSION DE - LÖSCHUNGSART</p>	<p>P3</p>	 <i>tenere premuto</i> <i>keep it pressed</i> <i>maintenir appuyé</i> <i>gedrückt halten</i>	 <i>suono intermittente</i> <i>intermittent sound</i> <i>son intermittent</i> <i>intermittierender Ton</i>	 <i>suono continuo</i> <i>continuous sound</i> <i>son continu</i> <i>Dauer-ton</i>
<p>IT - Singolo codice radio EN - Single radio code FR - Un seul code radio DE - Einzelner Sendekanal</p>	<p>* x1</p>		<p>IT - Premere il tasto del trasmettitore relativo al codice da cancellare. EN - Press the button of the transmitter relative to the code to delete. FR - Appuyer sur le bouton de l'émetteur concernant le code à supprimer. DE - Drücken Sie die Sendertaste die auf den zu löschenden Code bezogen ist.</p>	
<p>IT - Tutti i codici radio EN - All the radio codes FR - Tous les codes radio DE - Alle Sendekanäle</p>	<p>* x2</p>	 <p>(10s.)</p>		

2.1

IT - Memorizzazione remota di ulteriori codici radio FR - Mémorisation à distance d'autres codes radio

EN - Remote memorization of further radio codes DE - Fern-Speicherung von weiteren Sendekanälen



IT - Il tasto **P3** si trova all'interno del trasmettitore. Il codice radio aggiunto avrà le stesse funzioni del codice usato per l'inserimento. La procedura è compatibile con qualsiasi tipo di trasmettitore.

EN - **P3** button is located inside the transmitter. The added radio code will have the same functions of the code used for the memorization. This procedure is compatible with any type of transmitter.

FR - Le bouton **P3** se trouve à l'intérieur de l'émetteur. Le code radio ajouté aura les mêmes fonctions que le code utilisé pour la mémorisation. La procédure est compatible avec n'importe quel type d'émetteur.

DE - Die Taste **P3** befindet sich im Inneren des Senders. Der hinzugefügte Sendekanal wird dieselben Funktionen des Codes haben welcher für die Einlernung verwendet wurde. Die Prozedur kann mit allen Arten von Sendern durchgeführt werden.

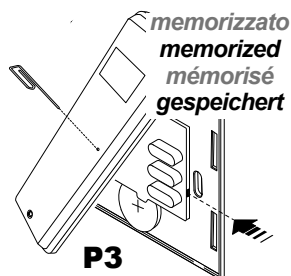

suono continuo
continuous sound
son continu
Dauerton



< 5 s.

memorizzato
memorized
mémorisé
gespeichert



1 s.

suono continuo
continuous sound
son continu
Dauerton



< 5 s.

nuovo
new
nouveau
neu



suono intermittente
intermittent sound
son intermittent
intermittierender Ton



IT - Premere il tasto **P3** del trasmettitore **memorizzato**. Premere il tasto relativo ad un codice **memorizzato**. Premere il tasto relativo al **nuovo** codice. **EN** - Press the button **P3** of the **memorized** transmitter. Press the button relative to a **memorized** code. Press the button relative to the **new** code. **FR** - Appuyer sur le bouton **P3** de l'émetteur **mémorisé**. Appuyer sur le bouton concernant un code **mémorisé**. Appuyer sur le bouton concernant le **nouveau** code. **DE** - Drücken Sie die Taste **P3** des **gespeicherten** Senders. Drücken Sie die auf den **gespeicherten** Code bezogene Taste. Drücken Sie die auf den **neuen** Code bezogene Taste.

2.2

IT - Cancellazione remota di un codice radio FR - Suppression à distance d'un code radio

EN - Remote deletion of a radio code DE - Fern-Löschung eines Sendekanals



IT - Il tasto **P3** si trova all'interno del trasmettitore.

EN - **P3** button is located inside the transmitter.

FR - Le bouton **P3** se trouve à l'intérieur de l'émetteur. **DE** - Die Taste **P3** befindet sich im Inneren des Senders.

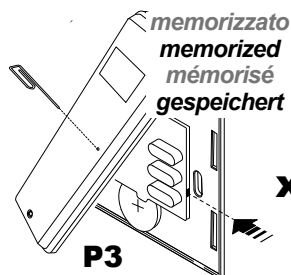

x 3

suono continuo
continuous sound
son continu
Dauerton



1 s.



suono intermittente
intermittent sound
son intermittent
intermittierender Ton



< 5 s.

suono continuo
continuous sound
son continu
Dauerton



IT - Premere tre volte il tasto **P3** del trasmettitore **memorizzato**. Premere il tasto relativo al codice da cancellare. **EN** - Press three times the button **P3** of the **memorized** transmitter. Press the button relative to the code to delete. **FR** - Appuyer trois fois sur le bouton **P3** de l'émetteur **mémorisé**. Appuyer sur le bouton concernant le code à supprimer. **DE** - Drücken Sie drei mal die Taste **P3** des **gespeicherten** Senders. Drücken Sie die auf den zu löschenden Code bezogene Taste.

3.1

IT - Attivazione/disattivazione memoria dell'ultimo valore di intensità luminosa

EN - Activation/deactivation of the memory of the last light intensity value

FR - Activation/désactivation de la mémoire à la dernière valeur d'intensité lumineuse

DE - Aktivierung/ Deaktivierung der Speicherung letzter Wert der Lichtintensität

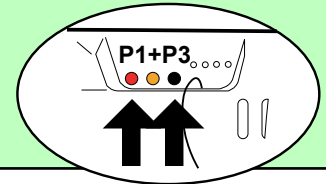

IT - Premere i tasti P1 e P3 contemporaneamente.
EN - Press the buttons P1 and P3 at the same time.
FR - Appuyer en même temps sur le boutons P1 et P3.
DE - Drücken Sie gleichzeitig die Tasten P1 und P3.



Attivazione
Activation
Activation
Aktivierung

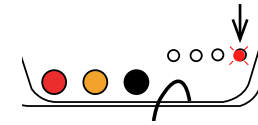

LED4 ON



Disattivazione
Deactivation
Désactivation
Deaktivierung

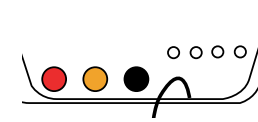

LED4 OFF

3.2

IT - Modifica dei valori di luminosità preimpostati di un trasmettitore 7/42 canali

EN - Modification of the preset light values of a 7/42 channel transmitter

FR - Modification des valeurs de luminosité pré réglées d'un émetteur 7/42 canaux

DE - Änderung der voreingestellten Helligkeitswerte eines 7/42-Kanal Senders

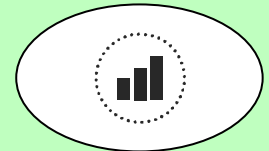

IT - Se un trasmettitore con valori di luminosità modificati viene usato nella memorizzazione remota (2.1), il trasmettitore aggiunto avrà gli stessi valori modificati.
EN - If any transmitter with modified light values is used in the remote memorization (2.1), the added transmitter will have the same modified values.
FR - Si un émetteur avec valeurs de luminosité modifiées est utilisé dans la mémorisation via radio (2.1), l'émetteur ajouté aura les mêmes valeurs modifiées.
DE - Wenn ein Sender mit geändertem Helligkeitswert für die Fern- Einlernung (2.1) verwendet wird, wird der Sender dieselben geänderten Werte haben.

1

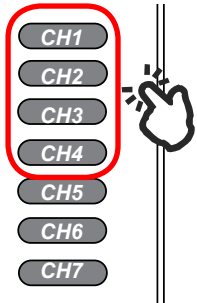

2



3



LED OFF



LED ON



suono continuo
continuous sound
son continu
Dauerton

IT - 1. Premere il tasto relativo al valore da modificare (CH1..CH4). 2. Regolare il valore con i tasti CH5 e CH6. 3. Premere e tenere premuto CH7 per 5s.
EN - 1. Press the button relative to the value to modify (CH1..CH4). 2. Adjust the value with buttons CH5 and CH6. 3. Press CH7 and keep it pressed for 5s.
FR - 1. Appuyer sur le bouton concernant la valeur à modifier (CH1..CH4). 2. Régler la valeur par mois des boutons CH5 et CH6. 3. Appuyer et maintenir appuyé CH7 pour 5s.
DE - 1. Drücken Sie die Taste bezüglich des zu ändernden Werts (CH1..CH4). 2. Stellen Sie den Wert mit den Tasten CH5 und CH6 ein. 3. CH7 drücken und halten Sie 5s. lang gedrückt.

