

500-750W, 18 to 32V or 18 to 60V Input Non-Isolated Step Down DC-DC Converter

<https://product.tdk.com/en/power/i7a>
www.emea.lambda.tdk.com/i7a



The i7A series of up to 750W non-isolated DC-DC step-down converters are ideal for creating additional high current/high power 33A and 45A output voltage rails from a single output 24V, 36V or 48V AC-DC or DC-DC power supply. The highly efficient i7A series has low ripple, excellent dynamic response under sudden load changes, accepts a wide DC input with a wide output adjustment range. Three mechanical configurations are available; low profile open frame, baseplate construction for conduction cooling, or models with an integral heat sink for convection or forced air cooling. The i7A series expands upon TDK-Lambda's existing 100 to 250W rated [i3A](#) / [i6A](#) series and reduces the need to parallel modules.

Features	Benefits
• Up to 750W in a 1/16th Brick Footprint	• High Power Density, Less Board Area Needed
• High Efficiency - Up to 98.5%	• Longer Battery Life / Less Power Consumed
• Wide 3.3 to 18V or 3.3 to 24V Output Adjustment	• One Part Supports Multiple System Voltages
• 18 to 32V or 18 to 60V Input Ranges	• Can Operate From Different DC Source Voltages Including Batteries
• Low Component Count With Minimal External Components	• Low Cost
• Minimal Derating Requirements in Low Airflow Environments	• Easy To Cool In End System

Model Selector								
Model	Input Voltage (V)	Output Voltage (V)	Max Current (A)	Max Power (W)	Positive Logic On/Off	Negative Logic On/Off	Integrated Baseplate	Integrated Heatsink
i7A4W033A033V-000-R	18 - 60	3.3 - 24	33	500	Yes	-	-	-
i7A4W033A033V-001-R	18 - 60	3.3 - 24	33	500	-	Yes	-	-
i7A4W033A033V-0C1-R	18 - 60	3.3 - 24	33	500	-	Yes	Yes	-
i7A4W033A033V-0F1-R	18 - 60	3.3 - 24	33	500	-	Yes	-	Yes
i7A24045A033V-000-R	18 - 32	3.3 - 18	45	750	Yes	-	-	-
i7A24045A033V-001-R	18 - 32	3.3 - 18	45	750	-	Yes	-	-
i7A24045A033V-0C1-R	18 - 32	3.3 - 18	45	750	-	Yes	Yes	-
i7A24045A033V-0F1-R	18 - 32	3.3 - 18	45	750	-	Yes	-	Yes

Preferred Model

Related Products		
Type	Part Number	Description
DC-DC Buck Converter	i3A	100W, Input 9-53V, Output 5-30V 4.5A or 3.3-16.5V 8A
DC-DC Buck Converter	i6AN	75W, Input 9-40V, Negative Output -3.3 to -30V, 8A
DC-DC Buck Converter	i6A24	250W, Input 9-40V, Output 3.3-24V 14A
DC-DC Buck Converter	i6A4W	250W, Input 9-53V, Output 3.3-40V 10A or 3.3-15V 20A
DC-DC Buck-Boost Converter	i7C	300W, Input 9-53V or 9-36V, Output 9.6-48V 8A, 5-28V 12.5A or 8-24V 20A
Evaluation Kit	i7A33A-C01-EVK-S1	Evaluation kit with i7A4W033A033V-001-R Full Module
	i7A45A-C01-EVK-S1	Evaluation kit with i7A24045A033V-001-R Module

Specification			
Model		i7A4W033A033V	i7A24045A033V
Input			
Input Voltage Range	Vdc	18-60 (Turn on at 16.5 typ)	18-32 (Turn on at 16.5 typ)
Input Transient (t < 100 ms)	Vdc	65 max	36 max
Input Current (max)	A	50	
Efficiency	%	91 - 98	93 - 98.5
Safety Agency Certifications	-	IEC/EN/UL/CSA 62368-1, CE Mark	
Output			
Output Voltage Tolerance	%	±3.5	
Switching Frequency	kHz	660	
Line Regulation	%	0.2	
Load Regulation	%	0.4	
External Load Capacitance	uF	220 - 10000	330 - 10000
Output Current	A	0 - 33	0 - 45
Ripple & Noise	mV	25	
Overcurrent Protection Threshold (typ)	A	45	63
Overtemperature Protection	-	Yes	
Remote Sense	-	(+) Sense, compensating up to 5% of output voltage	
Remote On/Off	-	See Model Selector table (Negative Logic: Von/off < 0.25V @ 1mA sink; Module = On)	
Output Adjust	-	See detailed specifications for trim equation.	
Dynamic Response	-	420 mV / 70 µs typ @ Vo=12V, 1 A/µs, 25% to 75% Step Load)	
Environmental			
Operating Temperature (Tref)	°C	-40 to 125 (See i7A Specifications for Derating)	
Storage Temperature	°C	-55° to +125	
Humidity (non condensing)	%RH	5 - 95 (Operating & Storage)	
Cooling	-	Convection, conduction (baseplate) or forced air	
Random Vibration (Operating)		IEC 60068-2-64 / IPC9592B: 2.40 Grms, 10-500 Hz, 30 min per x, y, z axis	
Shock (Operating)		IEC 60068-2-27 / IPC9592B: 30G, 11ms per x, y, z axis	
Other			
Weight (Typ)	g	Open Frame: 25g With Baseplate: 50g With Heatsink: 70g	
Size (LxWxH)	mm	Open Frame: 34 x 36.8 x 11.5 With Baseplate: 34 x 36.8 x 12.7 With Heatsink: 34 x 36.8 x 24.9	
Size (LxWxH)	Inches	Open Frame: 1.34 x 1.45 x 0.45 With Baseplate: 1.34 x 1.45 x 0.50 With Heatsink: 1.34 x 1.45 x 0.98	
MTBF - Telcordia SR-332	-	> 5 Mhrs; 100% Load; Ta = 40 °C	
Warranty	yrs	3	

Notes
See website for detailed [specifications](#) and test methods.

Typical Application Circuit

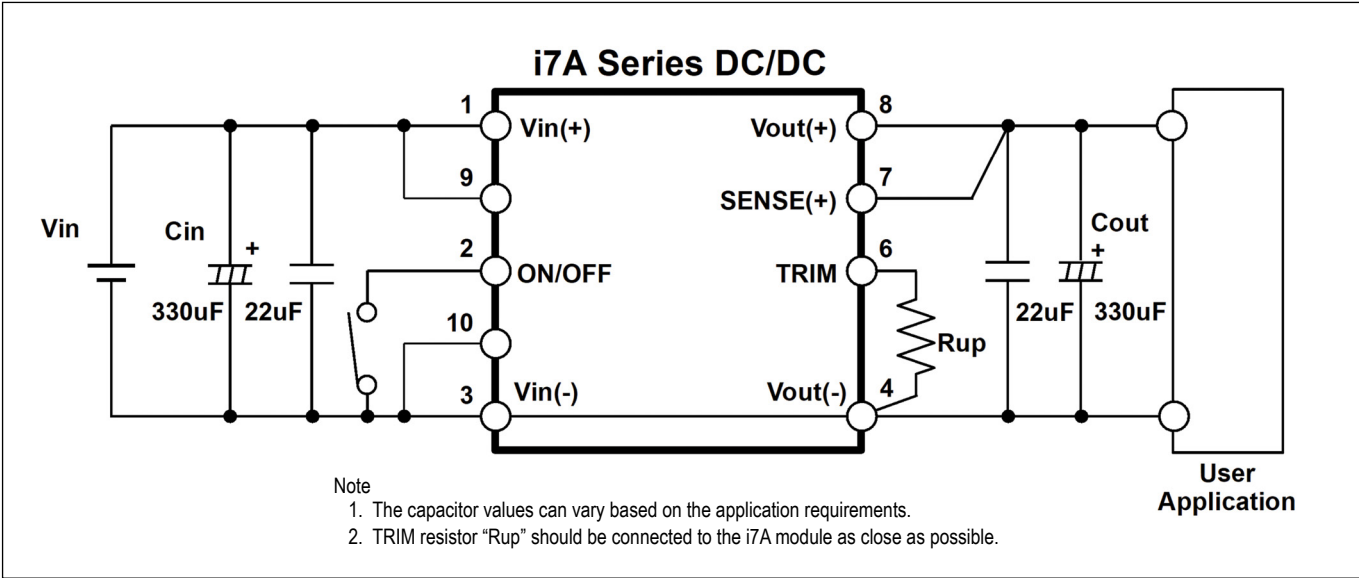

i7A4W033A033V: Output vs. Input Voltage Operating Range

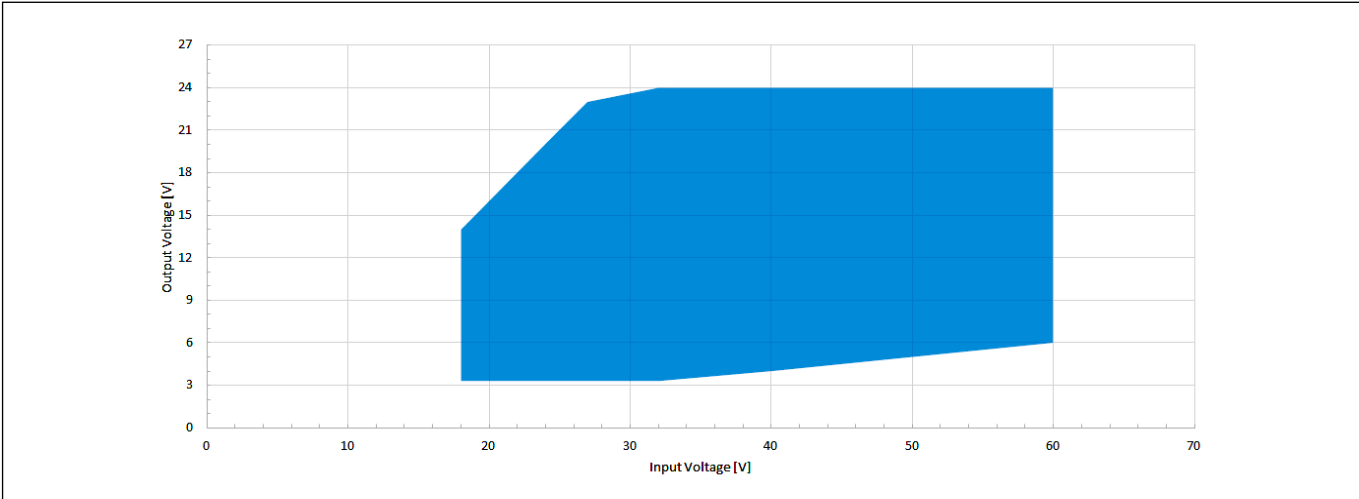

i7A24045A033V: Output vs. Input Voltage Operating Range

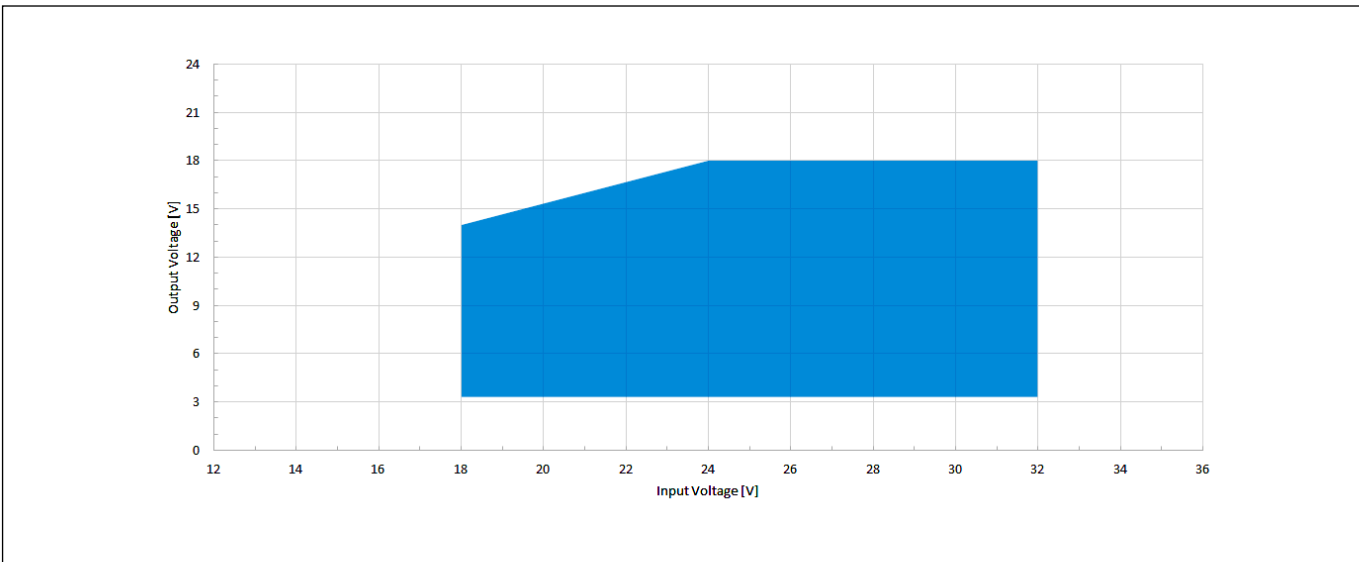

Mechanical Specification

Outline Drawing Open frame –00x-R product options

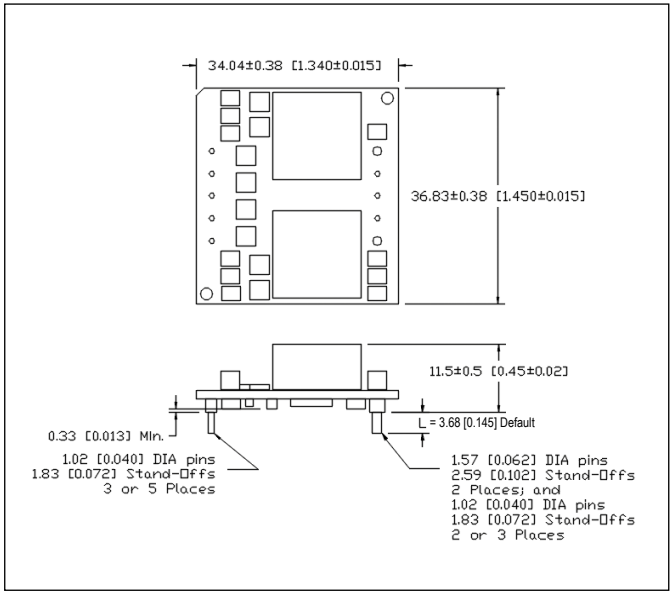

Outline Drawing With Baseplate –xCx-R product options

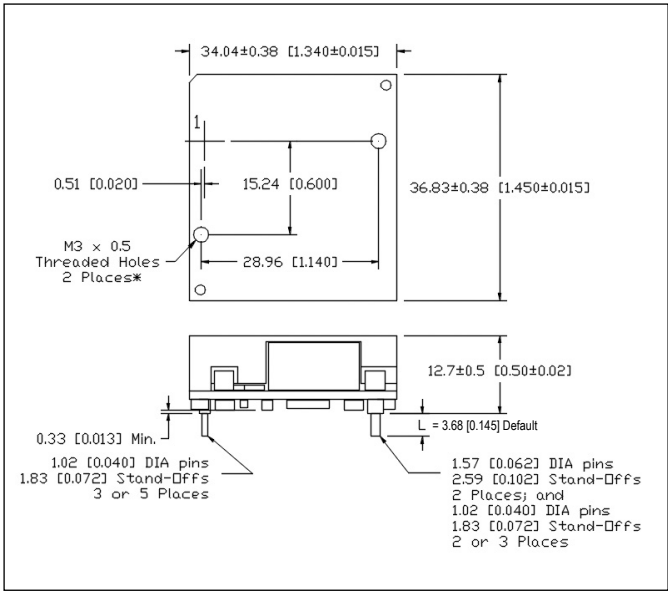

Outline Drawing With Heatsink –xFx-R product options

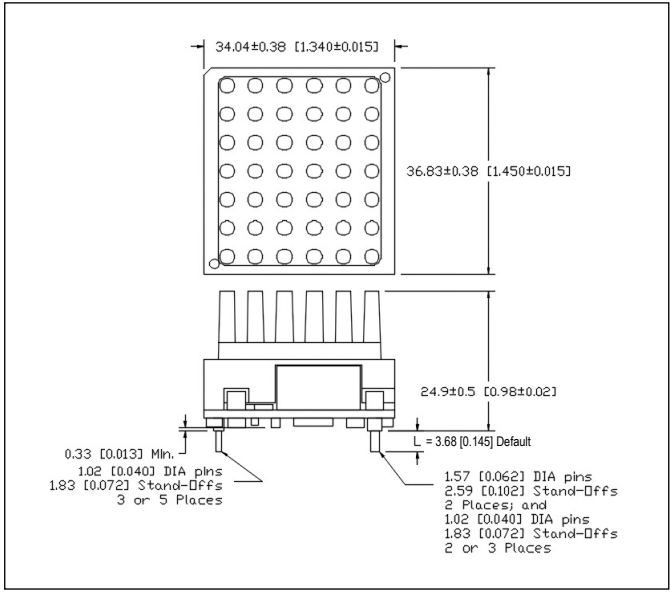

Mechanical Specification

Recommended Hole Pattern – i7A4W033A033V-xxx-R (Top View)

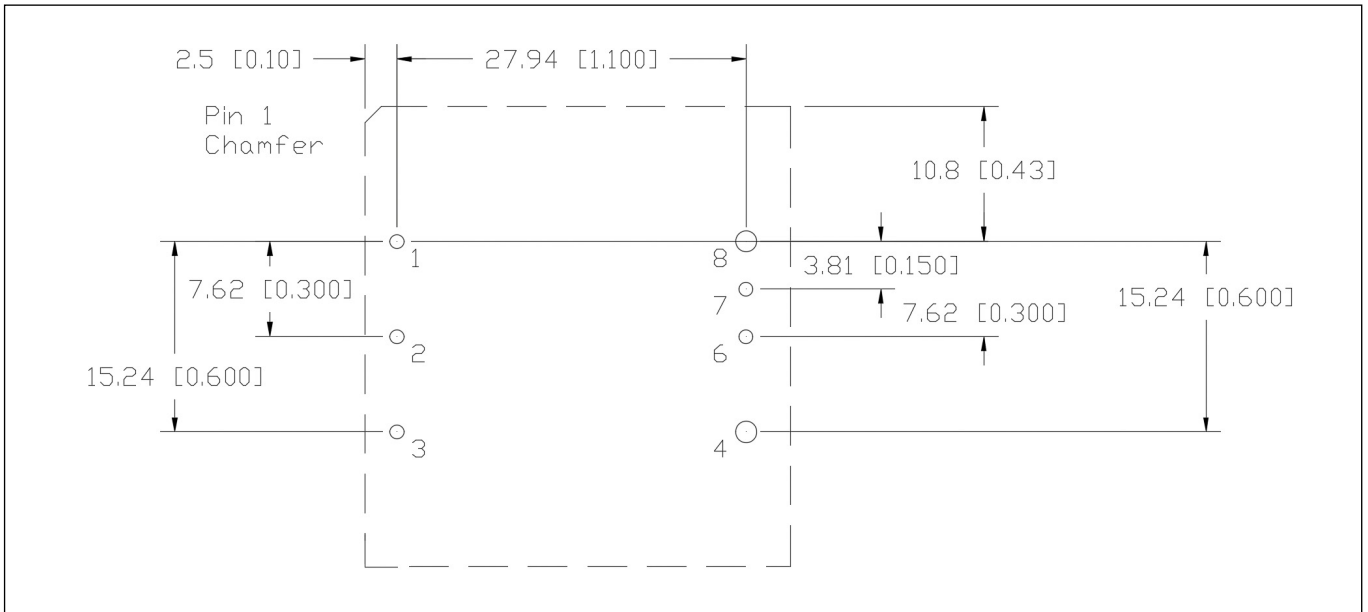

Recommended Hole Pattern – i7A24045A033V-xxx-R (Top View)

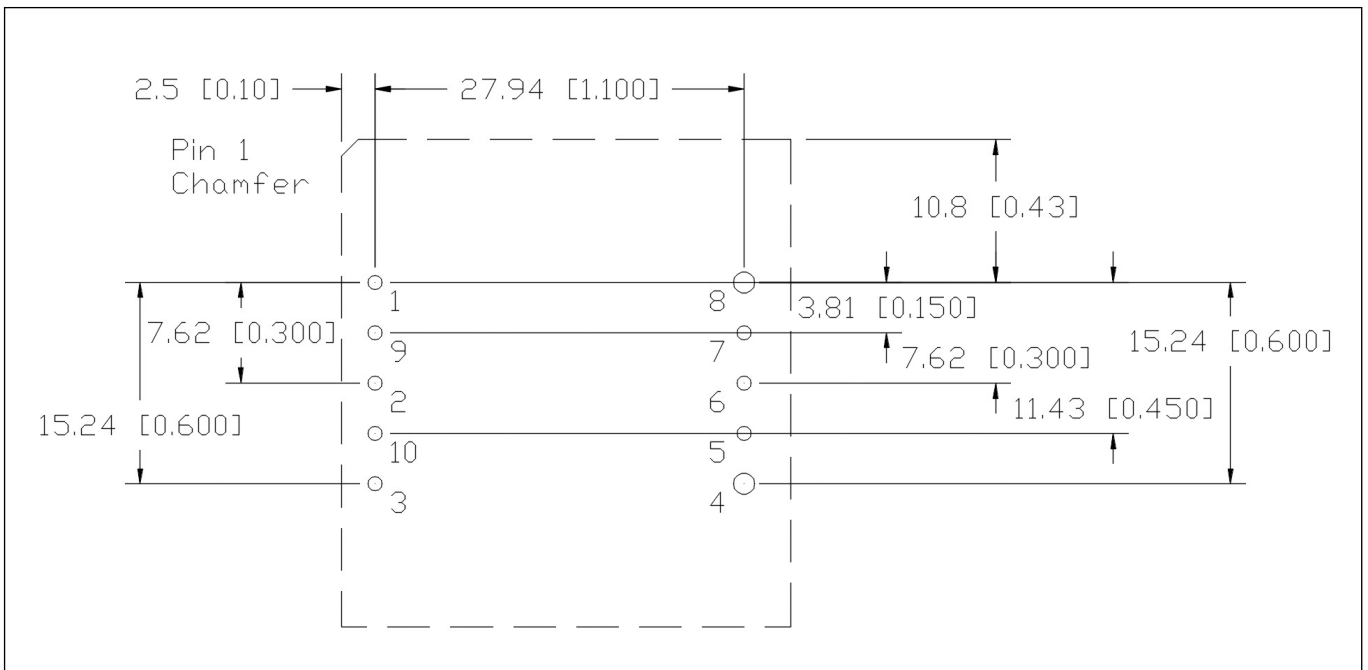

Pinout

PIN	Function	PIN	Function
1	VIN (+)	6	TRIM
2	ON / OFF	7	SENSE (+)
3	VIN (-) / GND	8	VOUT (+)
4	VOUT (-) / GND	9*	VIN (+)
5	Not Populated	10*	VIN (-) / GND

* Pin 9 & 10 are added for products drawing higher input currents (e.g. i7A24045A033V-xxx-R)
Pin base material is brass or copper with gold over nickel plating.



TDK-Lambda France SAS

Tel: +33 1 60 12 71 65
france@fr.tdk-lambda.com
www.emea.lambda.tdk.com/fr



Italy Sales Office

Tel: +39 02 61 29 38 63
info.italia@it.tdk-lambda.com
www.emea.lambda.tdk.com/it



Netherlands

info@nl.tdk-lambda.com
www.emea.lambda.tdk.com/nl



TDK-Lambda Germany GmbH

Tel: +49 7841 666 0
info.germany@de.tdk-lambda.com
www.emea.lambda.tdk.com/de



Austria Sales Office

Tel: +43 2256 655 84
info@at.tdk-lambda.com
www.emea.lambda.tdk.com/at



Switzerland Sales Office

Tel: +41 44 850 53 53
info@ch.tdk-lambda.com
www.emea.lambda.tdk.com/ch



Nordic Sales Office

Tel: +45 8853 8086
info@dk.tdk-lambda.com
www.emea.lambda.tdk.com/dk

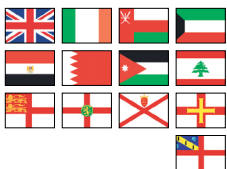

TDK-Lambda UK Ltd.

Tel: +44 (0) 12 71 85 66 66
powersolutions@uk.tdk-lambda.com
www.emea.lambda.tdk.com/uk



TDK-Lambda Ltd.

Tel: +9 723 902 4333
info@tdk-lambda.co.il
www.emea.lambda.tdk.com/il



C.I.S.

Commercial Support:

Tel: +7 (495) 665 2627

Technical Support:

Tel: +7 (812) 658 0463
info@tdk-lambda.ru
www.emea.lambda.tdk.com/ru



TDK-Lambda Americas

Tel: +1 800-LAMBDA-4 or 1-800-526-2324
powersolutions@us.tdk-lambda.com
www.us.lambda.tdk.com



TDK Electronics do Brasil Ltda

Tel: +55 11 3289-9599
sales.br@tdk-electronics.tdk.com
www.tdk-electronics.tdk.com/en



TDK-Lambda Corporation

Tel: +81-3-6778-1113
www.jp.lambda.tdk.com



TDK-Lambda (China) Electronics Co. Ltd.

Tel: +86 21 6485-0777
powersolutions@cn.tdk-lambda.com
www.lambda.tdk.com.cn



TDK-Lambda Singapore Pte Ltd.

Tel: +65 6251 7211
tis.mkt@sg.tdk-lambda.com
www.sg.lambda.tdk.com



TDK India Private Limited, Power Supply Division

Tel: +91 80 4039-0660
mathew.philip@in.tdk-lambda.com
www.sg.lambda.tdk.com

