



NEOZED-FLUSH MOUNTING FUSE BASE MOLDED PLASTIC,
 D01 1-POLE TOUCH PROTECTION (BGV A2) ACCESS:
 ELEVATOR TERMINAL OUTGOING: ELEVATOR
 TERMINAL 16A,
 AC 400V/DC 250V

Similar to image

Technical data:

Number of poles		1
Type of mounting		DIN rail
Operating current / rated value	A	16
Operating voltage / rated value	V	400
Material / of D fuse base		others
Product component / Cover		Yes
Size of the fallback-system / acc. to DIN EN 60269-1		D01

Certificates/approvals:

General Product Approval

Declaration of
Conformity

Test Certificates



[Type Test
Certificates/Test
Report](#)

Further information:

Information- and Downloadcenter (Catalogs, Brochures,...)

<http://www.siemens.com/lowvoltage/catalogs>

Industry Mall (Online ordering system)

<http://www.siemens.com/lowvoltage/mall>

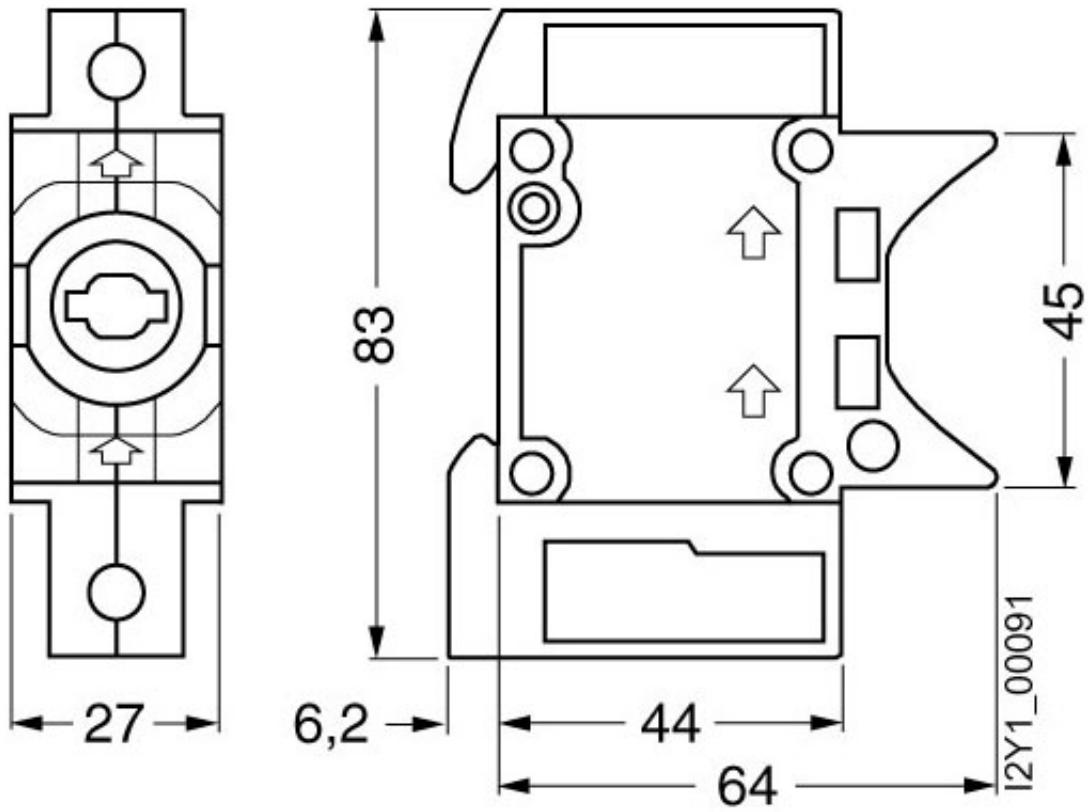



last change:

Oct 28, 2013