

CLIFF

FEED THROUGH CONNECTORS FT Series

The FT Series of true feed through connectors are perfect for developing custom I/O configurations for wall-plates, rack panels, etc. ALL fit within a standard XLR panel cutout, and use common cabling for front and back connections. No soldering, no punch terminations, just use the standard cable for that particular connector style. Mount from the front or back, low rear profile accommodates the tightest "behind the panel" spaces. Available in a wide variety of styles.

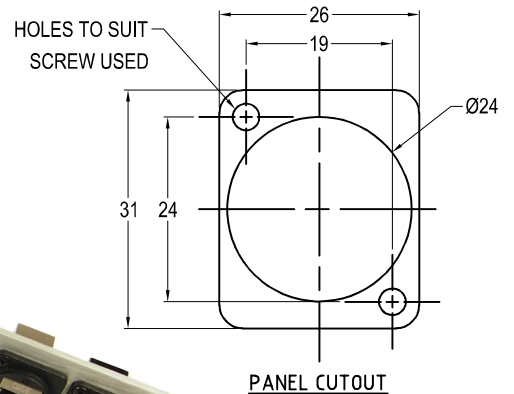

Part No.	Description
CP30200G	HDMI A Female to HDMI A, Gold Plated, CSK hole.
CP30200GX	As above with Plain hole.

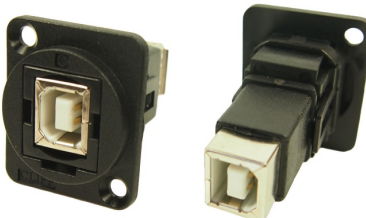

Part No.	Description
CP30203N	USB 2.0 B to USB 2.0 B, Nickel Plated, CSK hole.
CP30203NX	As above with Plain hole

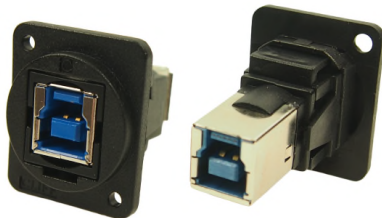

Part No.	Description
CP30204N	USB 3.0 B to USB 3.0 B, Nickel Plated, CSK hole.
CP30204NX	As above with Plain hole



Part No.	Description
CP30205N	USB 3.0 A to USB 3.0 A, Nickel Plated, CSK hole.
CP30205NX	As above with Plain hole

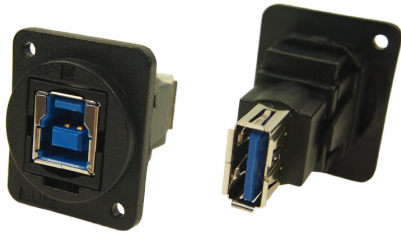

Part No. **Description**
CP30206N USB 3.0 B to USB 3.0 A, Nickel Plated, CSK hole.
CP30206NX As above with Plain hole



Part No. **Description**
CP30207N USB 2.0 B to USB 2.0 A, Nickel Plated, CSK hole.
CP30207NX As above with Plain hole

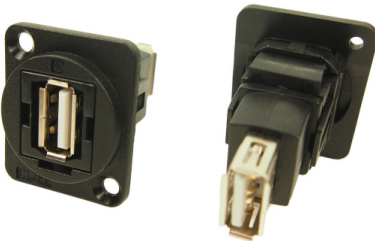

Part No. **Description**
CP30208N USB 2.0 A to USB 2.0 A, Nickel Plated, CSK hole.
CP30208NX As above with Plain hole

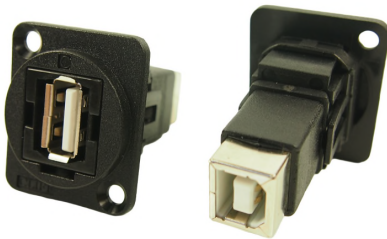

Part No. **Description**
CP30209N USB 2.0 A to USB 2.0 B, Nickel Plated, CSK hole.
CP30209NX As above with Plain hole

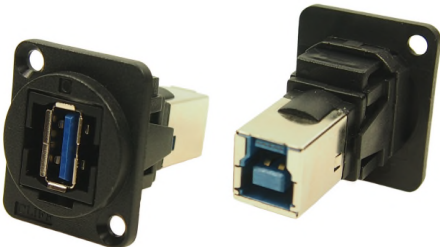

Part No. **Description**
CP30210N USB 3.0 A to USB 3.0 B, Nickel Plated, CSK hole.
CP30210NX As above with Plain hole



Part No. **Description**
CP30211 USB C Female to Male, Nickel Plated, CSK hole.
CP30211X As above with Plain hole



Part No. **Description**
CP30212 Dual USB C Female to Male, Nickel Plated, CSK hole.
CP30212X As above with Plain hole

For further information, contact sales@cliffuk.co.uk

Cliff Electronic Components Limited

76 Holmethorpe Avenue, Holmethorpe Ind. Estate,
Redhill, Surrey RH1 2PF U.K.

Tel: +44 (0)1737 771375 Fax: +44 (0)1737 766012

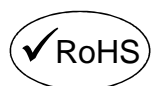

Visit us online at:
www.cliffuk.co.uk

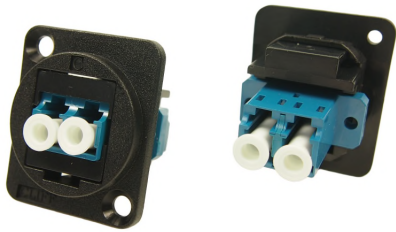

Part No.
CP30213
CP30213X

Description
LC Duplex SM adaptor, Black, CSK Hole
As above with Plain hole



Part No.
CP30214
CP30214X

Description
LC Duplex MM, Black, CSK Hole
As above with Plain hole



Part No.
CP30215
CP30215X

Description
SC Simplex SM, Black, CSK Hole
As above with Plain hole



Part No.
CP30216
CP30216X

Description
SC Simplex MM, Black, CSK Hole
As above with Plain hole



Part No.
CP30217
CP30217X

Description
Toslink, CSK Hole
As above with Plain hole



Part No.
CP30218
CP30218X

Description
ST Fibre, CSK Hole
As above with Plain hole



Part No.
CP30220
CP30220X

Description
UTP Cat5e RJ45-RJ45, CSK Hole
As above with Plain hole

For further information, contact sales@cliffuk.co.uk

Cliff Electronic Components Limited

76 Holmethorpe Avenue, Holmethorpe Ind. Estate,
Redhill, Surrey RH1 2PF U.K.

Tel: +44 (0)1737 771375 Fax: +44 (0)1737 766012



www.cliffuk.co.uk



Part No. Description
CP30220S FTP Cat5e RJ45-RJ45, Shielded, CSK Hole
CP30220SX As above with Plain hole

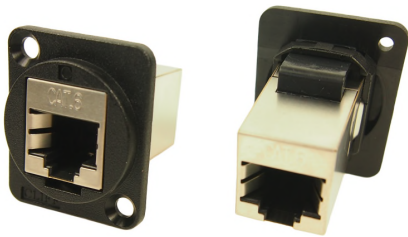

Part No. Description
CP30222S FTP Cat6 RJ45-RJ45, Shielded, CSK Hole
CP30222SX As above with Plain hole



Part No. Description
CP30222 UTP Cat6 RJ45-RJ45, CSK Hole
CP30222X As above with Plain hole



Part No. Description
CP30223 CAT3 RJ11 6P4C, CSK Hole
CP30223X As above with Plain hole

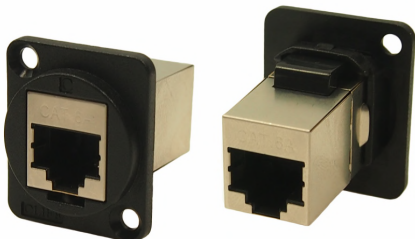

Part No. Description
CP30225S Cat6A RJ45-RJ45, Shielded, CSK Hole
CP30225SX As above with Plain hole



Part No. Description
CP30230 RCA Phono RED, CSK Hole
CP30230X As above with Plain hole
CP30231 RCA Phono WHITE, CSK Hole
CP30231X As above with Plain hole
CP30232 RCA Phono YELLOW, CSK Hole
CP30232X As above with Plain hole
 Other colours available on request.



Part No. Description
CP30240 2 Wire Terminal, CSK Hole
CP30240X As above with Plain hole
 Low voltage use only. Max rating 25VAC, 60VDC, 10A.

For further information, contact sales@cliffuk.co.uk

Cliff Electronic Components Limited

76 Holmethorpe Avenue, Holmethorpe Ind. Estate,
 Redhill, Surrey RH1 2PF U.K.
 Tel: +44 (0)1737 771375 Fax: +44 (0)1737 766012

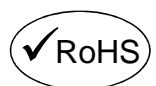

www.cliffuk.co.uk



Part No.	Description
CP30241	Blanking Plate, CSK Hole
CP30241X	As above with Plain hole



Part No.	Description
CP303090	BNC 50 Ohm, CSK Hole
CP303090X	As above with Plain hole



Part No.	Description
CP303095	BNC 75 Ohm, CSK Hole
CP303095X	As above with Plain hole

For further information, contact sales@cliffuk.co.uk

Cliff Electronic Components Limited

76 Holmethorpe Avenue, Holmethorpe Ind. Estate,
Redhill, Surrey RH1 2PF U.K.

Tel: +44 (0)1737 771375 Fax: +44 (0)1737 766012



www.cliffuk.co.uk