

R&S® Scope Rider RTH

Handheld Digital Oscilloscope

User Manual



1326.1578.02 – 08

This manual describes the following R&S®RTH models with firmware version 1.50:

- R&S®RTH1004 (1317.5000.K04)
- R&S®RTH1002 (1317.5000.K02)

In addition to the base unit, the following options are described:

- R&S®RTH-K1 I2C/SPI triggering and decoding (1325.9969.02)
- R&S®RTH-K2 UART/RS232 triggering and decoding (1325.9975.02)
- R&S®RTH-K3 CAN/LIN triggering & decoding (1333.0550.02)
- R&S®RTH-K15 History and segmented memory (1326.1803.02)
- R&S®RTH-K18 Spectrum analysis (1333.0680.02)
- R&S®RTH-K19 Advanced trigger (1326.0642.02)
- R&S®RTH-B1 Mixed signal option (1325.9981.02)
- R&S®RTH-K33 Frequency counter (1333.0696.02)
- R&S®RTH-K34 Harmonic analysis (1333.0673.02)

© 2017 Rohde & Schwarz GmbH & Co. KG

Mühlhofstr. 15, 81671 München, Germany

Phone: +49 89 41 29 - 0

Fax: +49 89 41 29 12 164

Email: info@rohde-schwarz.com

Internet: www.rohde-schwarz.com

Subject to change – Data without tolerance limits is not binding.

R&S® is a registered trademark of Rohde & Schwarz GmbH & Co. KG.

Trade names are trademarks of their owners.

Throughout this manual, products from Rohde & Schwarz are indicated without the ® symbol, e.g. R&S®Scope Rider RTH is indicated as R&S RTH.

Basic Safety Instructions

Always read through and comply with the following safety instructions!

All plants and locations of the Rohde & Schwarz group of companies make every effort to keep the safety standards of our products up to date and to offer our customers the highest possible degree of safety. Our products and the auxiliary equipment they require are designed, built and tested in accordance with the safety standards that apply in each case. Compliance with these standards is continuously monitored by our quality assurance system. The product described here has been designed, built and tested in accordance with the EC Certificate of Conformity and has left the manufacturer's plant in a condition fully complying with safety standards. To maintain this condition and to ensure safe operation, you must observe all instructions and warnings provided in this manual. If you have any questions regarding these safety instructions, the Rohde & Schwarz group of companies will be happy to answer them.

Furthermore, it is your responsibility to use the product in an appropriate manner. This product is designed for use solely in industrial and laboratory environments or, if expressly permitted, also in the field and must not be used in any way that may cause personal injury or property damage. You are responsible if the product is used for any purpose other than its designated purpose or in disregard of the manufacturer's instructions. The manufacturer shall assume no responsibility for such use of the product.

The product is used for its designated purpose if it is used in accordance with its product documentation and within its performance limits (see data sheet, documentation, the following safety instructions). Using the product requires technical skills and, in some cases, a basic knowledge of English. It is therefore essential that only skilled and specialized staff or thoroughly trained personnel with the required skills be allowed to use the product. If personal safety gear is required for using Rohde & Schwarz products, this will be indicated at the appropriate place in the product documentation. Keep the basic safety instructions and the product documentation in a safe place and pass them on to the subsequent users.

Observing the safety instructions will help prevent personal injury or damage of any kind caused by dangerous situations. Therefore, carefully read through and adhere to the following safety instructions before and when using the product. It is also absolutely essential to observe the additional safety instructions on personal safety, for example, that appear in relevant parts of the product documentation. In these safety instructions, the word "product" refers to all merchandise sold and distributed by the Rohde & Schwarz group of companies, including instruments, systems and all accessories. For product-specific information, see the data sheet and the product documentation.

Safety labels on products

The following safety labels are used on products to warn against risks and dangers.

Symbol	Meaning	Symbol	Meaning
	Notice, general danger location Observe product documentation		ON/OFF Power
	Caution when handling heavy equipment		Standby indication
	Danger of electric shock		Direct current (DC)

Basic Safety Instructions

Symbol	Meaning	Symbol	Meaning
	Caution ! Hot surface		Alternating current (AC)
	Protective conductor terminal To identify any terminal which is intended for connection to an external conductor for protection against electric shock in case of a fault, or the terminal of a protective earth		Direct/alternating current (DC/AC)
	Earth (Ground)		Class II Equipment to identify equipment meeting the safety requirements specified for Class II equipment (device protected by double or reinforced insulation)
	Frame or chassis Ground terminal		EU labeling for batteries and accumulators For additional information, see section "Waste disposal/Environmental protection", item 1.
	Be careful when handling electrostatic sensitive devices		EU labeling for separate collection of electrical and electronic devices For additional information, see section "Waste disposal/Environmental protection", item 2.
	Warning! Laser radiation For additional information, see section "Operation", item 7.		

Signal words and their meaning

The following signal words are used in the product documentation in order to warn the reader about risks and dangers.



Indicates a hazardous situation which, if not avoided, will result in death or serious injury.



Indicates a hazardous situation which, if not avoided, could result in death or serious injury.



Indicates a hazardous situation which, if not avoided, could result in minor or moderate injury.



Indicates information considered important, but not hazard-related, e.g. messages relating to property damage.

In the product documentation, the word ATTENTION is used synonymously.

These signal words are in accordance with the standard definition for civil applications in the European Economic Area. Definitions that deviate from the standard definition may also exist in other economic areas or military applications. It is therefore essential to make sure that the signal words described here are always used only in connection with the related product documentation and the related product. The use of signal words in connection with unrelated products or documentation can result in misinterpretation and in personal injury or material damage.

Basic Safety Instructions

Operating states and operating positions

The product may be operated only under the operating conditions and in the positions specified by the manufacturer, without the product's ventilation being obstructed. If the manufacturer's specifications are not observed, this can result in electric shock, fire and/or serious personal injury or death. Applicable local or national safety regulations and rules for the prevention of accidents must be observed in all work performed.

1. Unless otherwise specified, the following requirements apply to Rohde & Schwarz products: predefined operating position is always with the housing floor facing down, IP protection 2X, use only indoors, max. operating altitude 2000 m above sea level, max. transport altitude 4500 m above sea level. A tolerance of $\pm 10\%$ shall apply to the nominal voltage and $\pm 5\%$ to the nominal frequency, overvoltage category 2, pollution degree 2.
2. Do not place the product on surfaces, vehicles, cabinets or tables that for reasons of weight or stability are unsuitable for this purpose. Always follow the manufacturer's installation instructions when installing the product and fastening it to objects or structures (e.g. walls and shelves). An installation that is not carried out as described in the product documentation could result in personal injury or even death.
3. Do not place the product on heat-generating devices such as radiators or fan heaters. The ambient temperature must not exceed the maximum temperature specified in the product documentation or in the data sheet. Product overheating can cause electric shock, fire and/or serious personal injury or even death.

Electrical safety

If the information on electrical safety is not observed either at all or to the extent necessary, electric shock, fire and/or serious personal injury or death may occur.

1. Prior to switching on the product, always ensure that the nominal voltage setting on the product matches the nominal voltage of the mains-supply network. If a different voltage is to be set, the power fuse of the product may have to be changed accordingly.
2. In the case of products of safety class I with movable power cord and connector, operation is permitted only on sockets with a protective conductor contact and protective conductor.
3. Intentionally breaking the protective conductor either in the feed line or in the product itself is not permitted. Doing so can result in the danger of an electric shock from the product. If extension cords or connector strips are implemented, they must be checked on a regular basis to ensure that they are safe to use.
4. If there is no power switch for disconnecting the product from the mains, or if the power switch is not suitable for this purpose, use the plug of the connecting cable to disconnect the product from the mains. In such cases, always ensure that the power plug is easily reachable and accessible at all times. For example, if the power plug is the disconnecting device, the length of the connecting cable must not exceed 3 m. Functional or electronic switches are not suitable for providing disconnection from the AC supply network. If products without power switches are integrated into racks or systems, the disconnecting device must be provided at the system level.
5. Never use the product if the power cable is damaged. Check the power cables on a regular basis to ensure that they are in proper operating condition. By taking appropriate safety measures and carefully laying the power cable, ensure that the cable cannot be damaged and that no one can be hurt by, for example, tripping over the cable or suffering an electric shock.

Basic Safety Instructions

6. The product may be operated only from TN/TT supply networks fuse-protected with max. 16 A (higher fuse only after consulting with the Rohde & Schwarz group of companies).
7. Do not insert the plug into sockets that are dusty or dirty. Insert the plug firmly and all the way into the socket provided for this purpose. Otherwise, sparks that result in fire and/or injuries may occur.
8. Do not overload any sockets, extension cords or connector strips; doing so can cause fire or electric shocks.
9. For measurements in circuits with voltages $V_{rms} > 30$ V, suitable measures (e.g. appropriate measuring equipment, fuse protection, current limiting, electrical separation, insulation) should be taken to avoid any hazards.
10. Ensure that the connections with information technology equipment, e.g. PCs or other industrial computers, comply with the IEC 60950-1 / EN 60950-1 or IEC 61010-1 / EN 61010-1 standards that apply in each case.
11. Unless expressly permitted, never remove the cover or any part of the housing while the product is in operation. Doing so will expose circuits and components and can lead to injuries, fire or damage to the product.
12. If a product is to be permanently installed, the connection between the protective conductor terminal on site and the product's protective conductor must be made first before any other connection is made. The product may be installed and connected only by a licensed electrician.
13. For permanently installed equipment without built-in fuses, circuit breakers or similar protective devices, the supply circuit must be fuse-protected in such a way that anyone who has access to the product, as well as the product itself, is adequately protected from injury or damage.
14. Use suitable overvoltage protection to ensure that no overvoltage (such as that caused by a bolt of lightning) can reach the product. Otherwise, the person operating the product will be exposed to the danger of an electric shock.
15. Any object that is not designed to be placed in the openings of the housing must not be used for this purpose. Doing so can cause short circuits inside the product and/or electric shocks, fire or injuries.
16. Unless specified otherwise, products are not liquid-proof (see also section "Operating states and operating positions", item 1). Therefore, the equipment must be protected against penetration by liquids. If the necessary precautions are not taken, the user may suffer electric shock or the product itself may be damaged, which can also lead to personal injury.
17. Never use the product under conditions in which condensation has formed or can form in or on the product, e.g. if the product has been moved from a cold to a warm environment. Penetration by water increases the risk of electric shock.
18. Prior to cleaning the product, disconnect it completely from the power supply (e.g. AC supply network or battery). Use a soft, non-linting cloth to clean the product. Never use chemical cleaning agents such as alcohol, acetone or diluents for cellulose lacquers.

Operation

1. Operating the products requires special training and intense concentration. Make sure that persons who use the products are physically, mentally and emotionally fit enough to do so; otherwise, injuries or material damage may occur. It is the responsibility of the employer/operator to select suitable personnel for operating the products.

Basic Safety Instructions

2. Before you move or transport the product, read and observe the section titled "Transport".
3. As with all industrially manufactured goods, the use of substances that induce an allergic reaction (allergens) such as nickel cannot be generally excluded. If you develop an allergic reaction (such as a skin rash, frequent sneezing, red eyes or respiratory difficulties) when using a Rohde & Schwarz product, consult a physician immediately to determine the cause and to prevent health problems or stress.
4. Before you start processing the product mechanically and/or thermally, or before you take it apart, be sure to read and pay special attention to the section titled "Waste disposal/Environmental protection", item 1.
5. Depending on the function, certain products such as RF radio equipment can produce an elevated level of electromagnetic radiation. Considering that unborn babies require increased protection, pregnant women must be protected by appropriate measures. Persons with pacemakers may also be exposed to risks from electromagnetic radiation. The employer/operator must evaluate workplaces where there is a special risk of exposure to radiation and, if necessary, take measures to avert the potential danger.
6. Should a fire occur, the product may release hazardous substances (gases, fluids, etc.) that can cause health problems. Therefore, suitable measures must be taken, e.g. protective masks and protective clothing must be worn.
7. Laser products are given warning labels that are standardized according to their laser class. Lasers can cause biological harm due to the properties of their radiation and due to their extremely concentrated electromagnetic power. If a laser product (e.g. a CD/DVD drive) is integrated into a Rohde & Schwarz product, absolutely no other settings or functions may be used as described in the product documentation. The objective is to prevent personal injury (e.g. due to laser beams).
8. EMC classes (in line with EN 55011/CISPR 11, and analogously with EN 55022/CISPR 22, EN 55032/CISPR 32)
 - Class A equipment:
Equipment suitable for use in all environments except residential environments and environments that are directly connected to a low-voltage supply network that supplies residential buildings
Note: Class A equipment is intended for use in an industrial environment. This equipment may cause radio disturbances in residential environments, due to possible conducted as well as radiated disturbances. In this case, the operator may be required to take appropriate measures to eliminate these disturbances.
 - Class B equipment:
Equipment suitable for use in residential environments and environments that are directly connected to a low-voltage supply network that supplies residential buildings

Repair and service

1. The product may be opened only by authorized, specially trained personnel. Before any work is performed on the product or before the product is opened, it must be disconnected from the AC supply network. Otherwise, personnel will be exposed to the risk of an electric shock.

Basic Safety Instructions

- Adjustments, replacement of parts, maintenance and repair may be performed only by electrical experts authorized by Rohde & Schwarz. Only original parts may be used for replacing parts relevant to safety (e.g. power switches, power transformers, fuses). A safety test must always be performed after parts relevant to safety have been replaced (visual inspection, protective conductor test, insulation resistance measurement, leakage current measurement, functional test). This helps ensure the continued safety of the product.

Batteries and rechargeable batteries/cells

If the information regarding batteries and rechargeable batteries/cells is not observed either at all or to the extent necessary, product users may be exposed to the risk of explosions, fire and/or serious personal injury, and, in some cases, death. Batteries and rechargeable batteries with alkaline electrolytes (e.g. lithium cells) must be handled in accordance with the EN 62133 standard.

- Cells must not be taken apart or crushed.
- Cells or batteries must not be exposed to heat or fire. Storage in direct sunlight must be avoided. Keep cells and batteries clean and dry. Clean soiled connectors using a dry, clean cloth.
- Cells or batteries must not be short-circuited. Cells or batteries must not be stored in a box or in a drawer where they can short-circuit each other, or where they can be short-circuited by other conductive materials. Cells and batteries must not be removed from their original packaging until they are ready to be used.
- Cells and batteries must not be exposed to any mechanical shocks that are stronger than permitted.
- If a cell develops a leak, the fluid must not be allowed to come into contact with the skin or eyes. If contact occurs, wash the affected area with plenty of water and seek medical aid.
- Improperly replacing or charging cells or batteries that contain alkaline electrolytes (e.g. lithium cells) can cause explosions. Replace cells or batteries only with the matching Rohde & Schwarz type (see parts list) in order to ensure the safety of the product.
- Cells and batteries must be recycled and kept separate from residual waste. Rechargeable batteries and normal batteries that contain lead, mercury or cadmium are hazardous waste. Observe the national regulations regarding waste disposal and recycling.

Transport

- The product may be very heavy. Therefore, the product must be handled with care. In some cases, the user may require a suitable means of lifting or moving the product (e.g. with a lift-truck) to avoid back or other physical injuries.
- Handles on the products are designed exclusively to enable personnel to transport the product. It is therefore not permissible to use handles to fasten the product to or on transport equipment such as cranes, fork lifts, wagons, etc. The user is responsible for securely fastening the products to or on the means of transport or lifting. Observe the safety regulations of the manufacturer of the means of transport or lifting. Noncompliance can result in personal injury or material damage.
- If you use the product in a vehicle, it is the sole responsibility of the driver to drive the vehicle safely and properly. The manufacturer assumes no responsibility for accidents or collisions. Never use the product in a moving vehicle if doing so could distract the driver of the vehicle. Adequately secure the product in the vehicle to prevent injuries or other damage in the event of an accident.

Instrucciones de seguridad elementales

Waste disposal/Environmental protection

1. Specially marked equipment has a battery or accumulator that must not be disposed of with unsorted municipal waste, but must be collected separately. It may only be disposed of at a suitable collection point or via a Rohde & Schwarz customer service center.
2. Waste electrical and electronic equipment must not be disposed of with unsorted municipal waste, but must be collected separately.
Rohde & Schwarz GmbH & Co. KG has developed a disposal concept and takes full responsibility for take-back obligations and disposal obligations for manufacturers within the EU. Contact your Rohde & Schwarz customer service center for environmentally responsible disposal of the product.
3. If products or their components are mechanically and/or thermally processed in a manner that goes beyond their intended use, hazardous substances (heavy-metal dust such as lead, beryllium, nickel) may be released. For this reason, the product may only be disassembled by specially trained personnel. Improper disassembly may be hazardous to your health. National waste disposal regulations must be observed.
4. If handling the product releases hazardous substances or fuels that must be disposed of in a special way, e.g. coolants or engine oils that must be replenished regularly, the safety instructions of the manufacturer of the hazardous substances or fuels and the applicable regional waste disposal regulations must be observed. Also observe the relevant safety instructions in the product documentation. The improper disposal of hazardous substances or fuels can cause health problems and lead to environmental damage.

For additional information about environmental protection, visit the Rohde & Schwarz website.

Instrucciones de seguridad elementales

¡Es imprescindible leer y cumplir las siguientes instrucciones e informaciones de seguridad!

El principio del grupo de empresas Rohde & Schwarz consiste en tener nuestros productos siempre al día con los estándares de seguridad y de ofrecer a nuestros clientes el máximo grado de seguridad. Nuestros productos y todos los equipos adicionales son siempre fabricados y examinados según las normas de seguridad vigentes. Nuestro sistema de garantía de calidad controla constantemente que sean cumplidas estas normas. El presente producto ha sido fabricado y examinado según el certificado de conformidad de la UE y ha salido de nuestra planta en estado impecable según los estándares técnicos de seguridad. Para poder preservar este estado y garantizar un funcionamiento libre de peligros, el usuario deberá atenerse a todas las indicaciones, informaciones de seguridad y notas de alerta. El grupo de empresas Rohde & Schwarz está siempre a su disposición en caso de que tengan preguntas referentes a estas informaciones de seguridad.

Además queda en la responsabilidad del usuario utilizar el producto en la forma debida. Este producto está destinado exclusivamente al uso en la industria y el laboratorio o, si ha sido expresamente autorizado, para aplicaciones de campo y de ninguna manera deberá ser utilizado de modo que alguna persona/cosa pueda sufrir daño. El uso del producto fuera de sus fines definidos o sin tener en cuenta las instrucciones del fabricante queda en la responsabilidad del usuario. El fabricante no se hace en ninguna forma responsable de consecuencias a causa del mal uso del producto.















Instrucciones de seguridad elementales

Se parte del uso correcto del producto para los fines definidos si el producto es utilizado conforme a las indicaciones de la correspondiente documentación del producto y dentro del margen de rendimiento definido (ver hoja de datos, documentación, informaciones de seguridad que siguen). El uso del producto hace necesarios conocimientos técnicos y ciertos conocimientos del idioma inglés. Por eso se debe tener en cuenta que el producto solo pueda ser operado por personal especializado o personas instruidas en profundidad con las capacidades correspondientes. Si fuera necesaria indumentaria de seguridad para el uso de productos de Rohde & Schwarz, encontraría la información debida en la documentación del producto en el capítulo correspondiente. Guarde bien las informaciones de seguridad elementales, así como la documentación del producto, y entréguelas a usuarios posteriores.

Tener en cuenta las informaciones de seguridad sirve para evitar en lo posible lesiones o daños por peligros de toda clase. Por eso es imprescindible leer detalladamente y comprender por completo las siguientes informaciones de seguridad antes de usar el producto, y respetarlas durante el uso del producto. Deberán tenerse en cuenta todas las demás informaciones de seguridad, como p. ej. las referentes a la protección de personas, que encontrarán en el capítulo correspondiente de la documentación del producto y que también son de obligado cumplimiento. En las presentes informaciones de seguridad se recogen todos los objetos que distribuye el grupo de empresas Rohde & Schwarz bajo la denominación de "producto", entre ellos también aparatos, instalaciones así como toda clase de accesorios. Los datos específicos del producto figuran en la hoja de datos y en la documentación del producto.

Señalización de seguridad de los productos

Las siguientes señales de seguridad se utilizan en los productos para advertir sobre riesgos y peligros.

Símbolo	Significado	Símbolo	Significado
	Aviso: punto de peligro general Observar la documentación del producto		Tensión de alimentación de PUESTA EN MARCHA / PARADA
	Atención en el manejo de dispositivos de peso elevado		Indicación de estado de espera (standby)
	Peligro de choque eléctrico		Corriente continua (DC)
	Advertencia: superficie caliente		Corriente alterna (AC)
	Conexión a conductor de protección		Corriente continua / Corriente alterna (DC/AC)
	Conexión a tierra		El aparato está protegido en su totalidad por un aislamiento doble (reforzado)
	Conexión a masa		Distintivo de la UE para baterías y acumuladores Más información en la sección "Eliminación/protección del medio ambiente", punto 1.

Instrucciones de seguridad elementales

Símbolo	Significado	Símbolo	Significado
	Aviso: Cuidado en el manejo de dispositivos sensibles a la electrostática (ESD)		Distintivo de la UE para la eliminación por separado de dispositivos eléctricos y electrónicos Más información en la sección "Eliminación/protección del medio ambiente", punto 2.
	Advertencia: rayo láser Más información en la sección "Funcionamiento", punto 7.		

Palabras de señal y su significado

En la documentación del producto se utilizan las siguientes palabras de señal con el fin de advertir contra riesgos y peligros.



Indica una situación de peligro que, si no se evita, causa lesiones graves o incluso la muerte.



Indica una situación de peligro que, si no se evita, puede causar lesiones graves o incluso la muerte.



Indica una situación de peligro que, si no se evita, puede causar lesiones leves o moderadas.



Indica información que se considera importante, pero no en relación con situaciones de peligro; p. ej., avisos sobre posibles daños materiales.

En la documentación del producto se emplea de forma sinónima el término CUIDADO.

Las palabras de señal corresponden a la definición habitual para aplicaciones civiles en el área económica europea. Pueden existir definiciones diferentes a esta definición en otras áreas económicas o en aplicaciones militares. Por eso se deberá tener en cuenta que las palabras de señal aquí descritas sean utilizadas siempre solamente en combinación con la correspondiente documentación del producto y solamente en combinación con el producto correspondiente. La utilización de las palabras de señal en combinación con productos o documentaciones que no les correspondan puede llevar a interpretaciones equivocadas y tener por consecuencia daños en personas u objetos.

Estados operativos y posiciones de funcionamiento

El producto solamente debe ser utilizado según lo indicado por el fabricante respecto a los estados operativos y posiciones de funcionamiento sin que se obstruya la ventilación. Si no se siguen las indicaciones del fabricante, pueden producirse choques eléctricos, incendios y/o lesiones graves con posible consecuencia de muerte. En todos los trabajos deberán ser tenidas en cuenta las normas nacionales y locales de seguridad del trabajo y de prevención de accidentes.

Instrucciones de seguridad elementales

1. Si no se convino de otra manera, es para los productos Rohde & Schwarz válido lo que sigue: como posición de funcionamiento se define por principio la posición con el suelo de la caja para abajo, modo de protección IP 2X, uso solamente en estancias interiores, utilización hasta 2000 m sobre el nivel del mar, transporte hasta 4500 m sobre el nivel del mar. Se aplicará una tolerancia de $\pm 10\%$ sobre el voltaje nominal y de $\pm 5\%$ sobre la frecuencia nominal. Categoría de sobrecarga eléctrica 2, índice de suciedad 2.
2. No sitúe el producto encima de superficies, vehículos, estantes o mesas, que por sus características de peso o de estabilidad no sean aptos para él. Siga siempre las instrucciones de instalación del fabricante cuando instale y asegure el producto en objetos o estructuras (p. ej. paredes y estantes). Si se realiza la instalación de modo distinto al indicado en la documentación del producto, se pueden causar lesiones o, en determinadas circunstancias, incluso la muerte.
3. No ponga el producto sobre aparatos que generen calor (p. ej. radiadores o calefactores). La temperatura ambiente no debe superar la temperatura máxima especificada en la documentación del producto o en la hoja de datos. En caso de sobrecalentamiento del producto, pueden producirse choques eléctricos, incendios y/o lesiones graves con posible consecuencia de muerte.

Seguridad eléctrica

Si no se siguen (o se siguen de modo insuficiente) las indicaciones del fabricante en cuanto a seguridad eléctrica, pueden producirse choques eléctricos, incendios y/o lesiones graves con posible consecuencia de muerte.

1. Antes de la puesta en marcha del producto se deberá comprobar siempre que la tensión preseleccionada en el producto coincida con la de la red de alimentación eléctrica. Si es necesario modificar el ajuste de tensión, también se deberán cambiar en caso dado los fusibles correspondientes del producto.
2. Los productos de la clase de protección I con alimentación móvil y enchufe individual solamente podrán enchufarse a tomas de corriente con contacto de seguridad y con conductor de protección conectado.
3. Queda prohibida la interrupción intencionada del conductor de protección, tanto en la toma de corriente como en el mismo producto. La interrupción puede tener como consecuencia el riesgo de que el producto sea fuente de choques eléctricos. Si se utilizan cables alargadores o regletas de enchufe, deberá garantizarse la realización de un examen regular de los mismos en cuanto a su estado técnico de seguridad.
4. Si el producto no está equipado con un interruptor para desconectarlo de la red, o bien si el interruptor existente no resulta apropiado para la desconexión de la red, el enchufe del cable de conexión se deberá considerar como un dispositivo de desconexión. El dispositivo de desconexión se debe poder alcanzar fácilmente y debe estar siempre bien accesible. Si, p. ej., el enchufe de conexión a la red es el dispositivo de desconexión, la longitud del cable de conexión no debe superar 3 m). Los interruptores selectores o electrónicos no son aptos para el corte de la red eléctrica. Si se integran productos sin interruptor en bastidores o instalaciones, se deberá colocar el interruptor en el nivel de la instalación.
5. No utilice nunca el producto si está dañado el cable de conexión a red. Compruebe regularmente el correcto estado de los cables de conexión a red. Asegúrese, mediante las medidas de protección y de instalación adecuadas, de que el cable de conexión a red no pueda ser dañado o de que nadie pueda ser dañado por él, p. ej. al tropezar o por un choque eléctrico.

Instrucciones de seguridad elementales

6. Solamente está permitido el funcionamiento en redes de alimentación TN/TT aseguradas con fusibles de 16 A como máximo (utilización de fusibles de mayor amperaje solo previa consulta con el grupo de empresas Rohde & Schwarz).
7. Nunca conecte el enchufe en tomas de corriente sucias o llenas de polvo. Introduzca el enchufe por completo y fuertemente en la toma de corriente. La no observación de estas medidas puede provocar chispas, fuego y/o lesiones.
8. No sobrecargue las tomas de corriente, los cables alargadores o las regletas de enchufe ya que esto podría causar fuego o choques eléctricos.
9. En las mediciones en circuitos de corriente con una tensión $U_{\text{eff}} > 30 \text{ V}$ se deberán tomar las medidas apropiadas para impedir cualquier peligro (p. ej. medios de medición adecuados, seguros, limitación de tensión, corte protector, aislamiento etc.).
10. Para la conexión con dispositivos informáticos como un PC o un ordenador industrial, debe comprobarse que éstos cumplan los estándares IEC60950-1/EN60950-1 o IEC61010-1/EN 61010-1 válidos en cada caso.
11. A menos que esté permitido expresamente, no retire nunca la tapa ni componentes de la carcasa mientras el producto esté en servicio. Esto pone a descubierto los cables y componentes eléctricos y puede causar lesiones, fuego o daños en el producto.
12. Si un producto se instala en un lugar fijo, se deberá primero conectar el conductor de protección fijo con el conductor de protección del producto antes de hacer cualquier otra conexión. La instalación y la conexión deberán ser efectuadas por un electricista especializado.
13. En el caso de dispositivos fijos que no estén provistos de fusibles, interruptor automático ni otros mecanismos de seguridad similares, el circuito de alimentación debe estar protegido de modo que todas las personas que puedan acceder al producto, así como el producto mismo, estén a salvo de posibles daños.
14. Todo producto debe estar protegido contra sobretensión (debida p. ej. a una caída del rayo) mediante los correspondientes sistemas de protección. Si no, el personal que lo utilice quedará expuesto al peligro de choque eléctrico.
15. No debe introducirse en los orificios de la caja del aparato ningún objeto que no esté destinado a ello. Esto puede producir cortocircuitos en el producto y/o puede causar choques eléctricos, fuego o lesiones.
16. Salvo indicación contraria, los productos no están impermeabilizados (ver también el capítulo "Estados operativos y posiciones de funcionamiento", punto 1). Por eso es necesario tomar las medidas necesarias para evitar la entrada de líquidos. En caso contrario, existe peligro de choque eléctrico para el usuario o de daños en el producto, que también pueden redundar en peligro para las personas.
17. No utilice el producto en condiciones en las que pueda producirse o ya se hayan producido condensaciones sobre el producto o en el interior de éste, como p. ej. al desplazarlo de un lugar frío a otro caliente. La entrada de agua aumenta el riesgo de choque eléctrico.
18. Antes de la limpieza, desconecte por completo el producto de la alimentación de tensión (p. ej. red de alimentación o batería). Realice la limpieza de los aparatos con un paño suave, que no se deshilache. No utilice bajo ningún concepto productos de limpieza químicos como alcohol, acetona o diluyentes para lacas nitrocelulósicas.

Instrucciones de seguridad elementales

Funcionamiento

1. El uso del producto requiere instrucciones especiales y una alta concentración durante el manejo. Debe asegurarse que las personas que manejen el producto estén a la altura de los requerimientos necesarios en cuanto a aptitudes físicas, psíquicas y emocionales, ya que de otra manera no se pueden excluir lesiones o daños de objetos. El empresario u operador es responsable de seleccionar el personal usuario apto para el manejo del producto.
2. Antes de desplazar o transportar el producto, lea y tenga en cuenta el capítulo "Transporte".
3. Como con todo producto de fabricación industrial no puede quedar excluida en general la posibilidad de que se produzcan alergias provocadas por algunos materiales empleados —los llamados alérgenos (p. ej. el níquel)—. Si durante el manejo de productos Rohde & Schwarz se producen reacciones alérgicas, como p. ej. irritaciones cutáneas, estornudos continuos, enrojecimiento de la conjuntiva o dificultades respiratorias, debe avisarse inmediatamente a un médico para investigar las causas y evitar cualquier molestia o daño a la salud.
4. Antes de la manipulación mecánica y/o térmica o el desmontaje del producto, debe tenerse en cuenta imprescindiblemente el capítulo "Eliminación/protección del medio ambiente", punto 1.
5. Ciertos productos, como p. ej. las instalaciones de radiocomunicación RF, pueden a causa de su función natural, emitir una radiación electromagnética aumentada. Deben tomarse todas las medidas necesarias para la protección de las mujeres embarazadas. También las personas con marcapasos pueden correr peligro a causa de la radiación electromagnética. El empresario/operador tiene la obligación de evaluar y señalar las áreas de trabajo en las que exista un riesgo elevado de exposición a radiaciones.
6. Tenga en cuenta que en caso de incendio pueden desprenderse del producto sustancias tóxicas (gases, líquidos etc.) que pueden generar daños a la salud. Por eso, en caso de incendio deben usarse medidas adecuadas, como p. ej. máscaras antigás e indumentaria de protección.
7. Los productos con láser están provistos de indicaciones de advertencia normalizadas en función de la clase de láser del que se trate. Los rayos láser pueden provocar daños de tipo biológico a causa de las propiedades de su radiación y debido a su concentración extrema de potencia electromagnética. En caso de que un producto Rohde & Schwarz contenga un producto láser (p. ej. un lector de CD/DVD), no debe usarse ninguna otra configuración o función aparte de las descritas en la documentación del producto, a fin de evitar lesiones (p. ej. debidas a irradiación láser).
8. Clases de compatibilidad electromagnética (conforme a EN 55011 / CISPR 11; y en analogía con EN 55022 / CISPR 22, EN 55032 / CISPR 32)
 - Aparato de clase A:
Aparato adecuado para su uso en todos los entornos excepto en los residenciales y en aquellos conectados directamente a una red de distribución de baja tensión que suministra corriente a edificios residenciales.
Nota: Los aparatos de clase A están destinados al uso en entornos industriales. Estos aparatos pueden causar perturbaciones radioeléctricas en entornos residenciales debido a posibles perturbaciones guiadas o radiadas. En este caso, se le podrá solicitar al operador que tome las medidas adecuadas para eliminar estas perturbaciones.
 - Aparato de clase B:
Aparato adecuado para su uso en entornos residenciales, así como en aquellos conectados directamente a una red de distribución de baja tensión que suministra corriente a edificios residenciales.

Instrucciones de seguridad elementales

Reparación y mantenimiento

1. El producto solamente debe ser abierto por personal especializado con autorización para ello. Antes de manipular el producto o abrirlo, es obligatorio desconectarlo de la tensión de alimentación, para evitar toda posibilidad de choque eléctrico.
2. El ajuste, el cambio de partes, el mantenimiento y la reparación deberán ser efectuadas solamente por electricistas autorizados por Rohde & Schwarz. Si se reponen partes con importancia para los aspectos de seguridad (p. ej. el enchufe, los transformadores o los fusibles), solamente podrán ser sustituidos por partes originales. Después de cada cambio de partes relevantes para la seguridad deberá realizarse un control de seguridad (control a primera vista, control del conductor de protección, medición de resistencia de aislamiento, medición de la corriente de fuga, control de funcionamiento). Con esto queda garantizada la seguridad del producto.

Baterías y acumuladores o celdas

Si no se siguen (o se siguen de modo insuficiente) las indicaciones en cuanto a las baterías y acumuladores o celdas, pueden producirse explosiones, incendios y/o lesiones graves con posible consecuencia de muerte. El manejo de baterías y acumuladores con electrolitos alcalinos (p. ej. celdas de litio) debe seguir el estándar EN 62133.

1. No deben desmontarse, abrirse ni triturarse las celdas.
2. Las celdas o baterías no deben someterse a calor ni fuego. Debe evitarse el almacenamiento a la luz directa del sol. Las celdas y baterías deben mantenerse limpias y secas. Limpiar las conexiones sucias con un paño seco y limpio.
3. Las celdas o baterías no deben cortocircuitarse. Es peligroso almacenar las celdas o baterías en estuches o cajones en cuyo interior puedan cortocircuitarse por contacto recíproco o por contacto con otros materiales conductores. No deben extraerse las celdas o baterías de sus embalajes originales hasta el momento en que vayan a utilizarse.
4. Las celdas o baterías no deben someterse a impactos mecánicos fuertes indebidos.
5. En caso de falta de estanqueidad de una celda, el líquido vertido no debe entrar en contacto con la piel ni los ojos. Si se produce contacto, lavar con agua abundante la zona afectada y avisar a un médico.
6. En caso de cambio o recarga inadecuados, las celdas o baterías que contienen electrolitos alcalinos (p. ej. las celdas de litio) pueden explotar. Para garantizar la seguridad del producto, las celdas o baterías solo deben ser sustituidas por el tipo Rohde & Schwarz correspondiente (ver lista de recambios).
7. Las baterías y celdas deben reciclarse y no deben tirarse a la basura doméstica. Las baterías o acumuladores que contienen plomo, mercurio o cadmio deben tratarse como residuos especiales. Respete en esta relación las normas nacionales de eliminación y reciclaje.

Transporte

1. El producto puede tener un peso elevado. Por eso es necesario desplazarlo o transportarlo con precaución y, si es necesario, usando un sistema de elevación adecuado (p. ej. una carretilla elevadora), a fin de evitar lesiones en la espalda u otros daños personales.

Instrucciones de seguridad elementales

2. Las asas instaladas en los productos sirven solamente de ayuda para el transporte del producto por personas. Por eso no está permitido utilizar las asas para la sujeción en o sobre medios de transporte como p. ej. grúas, carretillas elevadoras de horquilla, carros etc. Es responsabilidad suya fijar los productos de manera segura a los medios de transporte o elevación. Para evitar daños personales o daños en el producto, siga las instrucciones de seguridad del fabricante del medio de transporte o elevación utilizado.
3. Si se utiliza el producto dentro de un vehículo, recae de manera exclusiva en el conductor la responsabilidad de conducir el vehículo de manera segura y adecuada. El fabricante no asumirá ninguna responsabilidad por accidentes o colisiones. No utilice nunca el producto dentro de un vehículo en movimiento si esto pudiera distraer al conductor. Asegure el producto dentro del vehículo debidamente para evitar, en caso de un accidente, lesiones u otra clase de daños.

Eliminación/protección del medio ambiente

1. Los dispositivos marcados contienen una batería o un acumulador que no se debe desechar con los residuos domésticos sin clasificar, sino que debe ser recogido por separado. La eliminación se debe efectuar exclusivamente a través de un punto de recogida apropiado o del servicio de atención al cliente de Rohde & Schwarz.
2. Los dispositivos eléctricos usados no se deben desechar con los residuos domésticos sin clasificar, sino que deben ser recogidos por separado.
Rohde & Schwarz GmbH & Co.KG ha elaborado un concepto de eliminación de residuos y asume plenamente los deberes de recogida y eliminación para los fabricantes dentro de la UE. Para desechar el producto de manera respetuosa con el medio ambiente, dirijase a su servicio de atención al cliente de Rohde & Schwarz.
3. Si se trabaja de manera mecánica y/o térmica cualquier producto o componente más allá del funcionamiento previsto, pueden liberarse sustancias peligrosas (polvos con contenido de metales pesados como p. ej. plomo, berilio o níquel). Por eso el producto solo debe ser desmontado por personal especializado con formación adecuada. Un desmontaje inadecuado puede ocasionar daños para la salud. Se deben tener en cuenta las directivas nacionales referentes a la eliminación de residuos.
4. En caso de que durante el trato del producto se formen sustancias peligrosas o combustibles que deban tratarse como residuos especiales (p. ej. refrigerantes o aceites de motor con intervalos de cambio definidos), deben tenerse en cuenta las indicaciones de seguridad del fabricante de dichas sustancias y las normas regionales de eliminación de residuos. Tenga en cuenta también en caso necesario las indicaciones de seguridad especiales contenidas en la documentación del producto. La eliminación incorrecta de sustancias peligrosas o combustibles puede causar daños a la salud o daños al medio ambiente.

Se puede encontrar más información sobre la protección del medio ambiente en la página web de Rohde & Schwarz.

Grundlegende Sicherheitshinweise

Lesen und beachten Sie unbedingt die nachfolgenden Anweisungen und Sicherheitshinweise!

Alle Werke und Standorte der Rohde & Schwarz Firmengruppe sind ständig bemüht, den Sicherheitsstandard unserer Produkte auf dem aktuellsten Stand zu halten und unseren Kunden ein höchstmögliches Maß an Sicherheit zu bieten. Unsere Produkte und die dafür erforderlichen Zusatzgeräte werden entsprechend der jeweils gültigen Sicherheitsvorschriften gebaut und geprüft. Die Einhaltung dieser Bestimmungen wird durch unser Qualitätssicherungssystem laufend überwacht. Das vorliegende Produkt ist gemäß beiliegender EU-Konformitätsbescheinigung gebaut und geprüft und hat das Werk in sicherheitstechnisch einwandfreiem Zustand verlassen. Um diesen Zustand zu erhalten und einen gefahrlosen Betrieb sicherzustellen, muss der Benutzer alle Hinweise, Warnhinweise und Warnvermerke beachten. Bei allen Fragen bezüglich vorliegender Sicherheitshinweise steht Ihnen die Rohde & Schwarz Firmengruppe jederzeit gerne zur Verfügung.













Darüber hinaus liegt es in der Verantwortung des Benutzers, das Produkt in geeigneter Weise zu verwenden. Das Produkt ist ausschließlich für den Betrieb in Industrie und Labor bzw., wenn ausdrücklich zugelassen, auch für den Feldeinsatz bestimmt und darf in keiner Weise so verwendet werden, dass einer Person/Sache Schaden zugefügt werden kann. Die Benutzung des Produkts außerhalb des bestimmungsgemäßen Gebrauchs oder unter Missachtung der Anweisungen des Herstellers liegt in der Verantwortung des Benutzers. Der Hersteller übernimmt keine Verantwortung für die Zweckentfremdung des Produkts.

Die bestimmungsgemäße Verwendung des Produkts wird angenommen, wenn das Produkt nach den Vorgaben der zugehörigen Produktdokumentation innerhalb seiner Leistungsgrenzen verwendet wird (siehe Datenblatt, Dokumentation, nachfolgende Sicherheitshinweise). Die Benutzung des Produkts erfordert Fachkenntnisse und zum Teil englische Sprachkenntnisse. Es ist daher zu beachten, dass das Produkt ausschließlich von Fachkräften oder sorgfältig eingewiesenen Personen mit entsprechenden Fähigkeiten bedient werden darf. Sollte für die Verwendung von Rohde & Schwarz-Produkten persönliche Schutzausrüstung erforderlich sein, wird in der Produktdokumentation an entsprechender Stelle darauf hingewiesen. Bewahren Sie die grundlegenden Sicherheitshinweise und die Produktdokumentation gut auf und geben Sie diese an weitere Benutzer des Produkts weiter.

Die Einhaltung der Sicherheitshinweise dient dazu, Verletzungen oder Schäden durch Gefahren aller Art auszuschließen. Hierzu ist es erforderlich, dass die nachstehenden Sicherheitshinweise vor der Benutzung des Produkts sorgfältig gelesen und verstanden sowie bei der Benutzung des Produkts beachtet werden. Sämtliche weitere Sicherheitshinweise wie z.B. zum Personenschutz, die an entsprechender Stelle der Produktdokumentation stehen, sind ebenfalls unbedingt zu beachten. In den vorliegenden Sicherheitshinweisen sind sämtliche von der Rohde & Schwarz Firmengruppe vertriebenen Waren unter dem Begriff „Produkt“ zusammengefasst, hierzu zählen u. a. Geräte, Anlagen sowie sämtliches Zubehör.

Grundlegende Sicherheitshinweise

Symbole und Sicherheitskennzeichnungen

Symbol	Bedeutung	Symbol	Bedeutung
	Achtung, allgemeine Gefahrenstelle Produktdokumentation beachten	○	EIN-/AUS (Versorgung)
	Vorsicht beim Umgang mit Geräten mit hohem Gewicht	⏻	Stand-by-Anzeige
	Gefahr vor elektrischem Schlag	≡	Gleichstrom (DC)
	Warnung vor heißer Oberfläche	~	Wechselstrom (AC)
	Schutzleiteranschluss	⎓	Gleichstrom/Wechselstrom (DC/AC)
	Erdungsanschluss		Gerät entspricht den Sicherheitsanforderungen an die Schutzklasse II (Gerät durchgehend durch doppelte / verstärkte Isolierung geschützt).
	Masseanschluss des Gestells oder Gehäuses		EU - Kennzeichnung für Batterien und Akkumulatoren. Das Gerät enthält eine Batterie bzw. einen Akkumulator. Diese dürfen nicht über unsortierten Siedlungsabfall entsorgt werden, sondern sollten getrennt gesammelt werden. Weitere Informationen siehe Seite 7.
	Achtung beim Umgang mit elektrostatisch gefährdeten Bauelementen		EU - Kennzeichnung für die getrennte Sammlung von Elektro- und Elektronikgeräten. Elektroaltgeräte dürfen nicht über unsortierten Siedlungsabfall entsorgt werden, sondern müssen getrennt gesammelt werden. Weitere Informationen siehe Seite 7.
	Warnung vor Laserstrahl Produkte mit Laser sind je nach ihrer Laser-Klasse mit genormten Warnhinweisen versehen. Laser können aufgrund der Eigenschaften ihrer Strahlung und aufgrund ihrer extrem konzentrierten elektromagnetischen Leistung biologische Schäden verursachen. Für zusätzliche Informationen siehe Kapitel „Betrieb“ Punkt 7.		

Grundlegende Sicherheitshinweise

Signalworte und ihre Bedeutung

Die folgenden Signalworte werden in der Produktdokumentation verwendet, um vor Risiken und Gefahren zu warnen.



kennzeichnet eine unmittelbare Gefährdung mit hohem Risiko, die Tod oder schwere Körperverletzung zur Folge haben wird, wenn sie nicht vermieden wird.



kennzeichnet eine mögliche Gefährdung mit mittlerem Risiko, die Tod oder (schwere) Körperverletzung zur Folge haben kann, wenn sie nicht vermieden wird.



kennzeichnet eine Gefährdung mit geringem Risiko, die leichte oder mittlere Körperverletzungen zur Folge haben könnte, wenn sie nicht vermieden wird.



weist auf die Möglichkeit einer Fehlbedienung hin, bei der das Produkt Schaden nehmen kann.

Diese Signalworte entsprechen der im europäischen Wirtschaftsraum üblichen Definition für zivile Anwendungen. Neben dieser Definition können in anderen Wirtschaftsräumen oder bei militärischen Anwendungen abweichende Definitionen existieren. Es ist daher darauf zu achten, dass die hier beschriebenen Signalworte stets nur in Verbindung mit der zugehörigen Produktdokumentation und nur in Verbindung mit dem zugehörigen Produkt verwendet werden. Die Verwendung von Signalworten in Zusammenhang mit nicht zugehörigen Produkten oder nicht zugehörigen Dokumentationen kann zu Fehlinterpretationen führen und damit zu Personen- oder Sachschäden führen.

Betriebszustände und Betriebslagen

Das Produkt darf nur in den vom Hersteller angegebenen Betriebszuständen und Betriebslagen ohne Behinderung der Belüftung betrieben werden. Werden die Herstellerangaben nicht eingehalten, kann dies elektrischen Schlag, Brand und/oder schwere Verletzungen von Personen, unter Umständen mit Todesfolge, verursachen. Bei allen Arbeiten sind die örtlichen bzw. landesspezifischen Sicherheits- und Unfallverhütungsvorschriften zu beachten.

1. Sofern nicht anders vereinbart, gilt für R&S-Produkte folgendes:
als vorgeschriebene Betriebslage grundsätzlich Gehäuseboden unten, IP-Schutzart 2X, Verschmutzungsgrad 2, Überspannungskategorie 2, nur in Innenräumen verwenden, Betrieb bis 2000 m ü. NN, Transport bis 4500 m ü. NN, für die Nennspannung gilt eine Toleranz von $\pm 10\%$, für die Nennfrequenz eine Toleranz von $\pm 5\%$.
2. Stellen Sie das Produkt nicht auf Oberflächen, Fahrzeuge, Ablagen oder Tische, die aus Gewichts- oder Stabilitätsgründen nicht dafür geeignet sind. Folgen Sie bei Aufbau und Befestigung des Produkts an Gegenständen oder Strukturen (z.B. Wände und Regale) immer den Installationshinweisen des Herstellers. Bei Installation abweichend von der Produktdokumentation können Personen verletzt, unter Umständen sogar getötet werden.
3. Stellen Sie das Produkt nicht auf hitzerzeugende Gerätschaften (z.B. Radiatoren und Heizlüfter). Die Umgebungstemperatur darf nicht die in der Produktdokumentation oder im Datenblatt spezifizierte Maximaltemperatur überschreiten. Eine Überhitzung des Produkts kann elektrischen Schlag, Brand und/oder schwere Verletzungen von Personen, unter Umständen mit Todesfolge, verursachen.

Grundlegende Sicherheitshinweise

Elektrische Sicherheit

Werden die Hinweise zur elektrischen Sicherheit nicht oder unzureichend beachtet, kann dies elektrischen Schlag, Brand und/oder schwere Verletzungen von Personen, unter Umständen mit Todesfolge, verursachen.

1. Vor jedem Einschalten des Produkts ist sicherzustellen, dass die am Produkt eingestellte Nennspannung und die Netzennspannung des Versorgungsnetzes übereinstimmen. Ist es erforderlich, die Spannungseinstellung zu ändern, so muss ggf. auch die dazu gehörige Netzsicherung des Produkts geändert werden.
2. Bei Produkten der Schutzklasse I mit beweglicher Netzzuleitung und Gerätesteckvorrichtung ist der Betrieb nur an Steckdosen mit Schutzkontakt und angeschlossenem Schutzleiter zulässig.
3. Jegliche absichtliche Unterbrechung des Schutzleiters, sowohl in der Zuleitung als auch am Produkt selbst, ist unzulässig. Es kann dazu führen, dass von dem Produkt die Gefahr eines elektrischen Schlags ausgeht. Bei Verwendung von Verlängerungsleitungen oder Steckdosenleisten ist sicherzustellen, dass diese regelmäßig auf ihren sicherheitstechnischen Zustand überprüft werden.
4. Sofern das Produkt nicht mit einem Netzschalter zur Netztrennung ausgerüstet ist, beziehungsweise der vorhandene Netzschalter zu Netztrennung nicht geeignet ist, so ist der Stecker des Anschlusskabels als Trennvorrichtung anzusehen.
Die Trennvorrichtung muss jederzeit leicht erreichbar und gut zugänglich sein. Ist z.B. der Netzstecker die Trennvorrichtung, darf die Länge des Anschlusskabels 3 m nicht überschreiten.
Funktionsschalter oder elektronische Schalter sind zur Netztrennung nicht geeignet. Werden Produkte ohne Netzschalter in Gestelle oder Anlagen integriert, so ist die Trennvorrichtung auf Anlagenebene zu verlagern.
5. Benutzen Sie das Produkt niemals, wenn das Netzkabel beschädigt ist. Überprüfen Sie regelmäßig den einwandfreien Zustand der Netzkabel. Stellen Sie durch geeignete Schutzmaßnahmen und Verlegearten sicher, dass das Netzkabel nicht beschädigt werden kann und niemand z.B. durch Stolperfallen oder elektrischen Schlag zu Schaden kommen kann.
6. Der Betrieb ist nur an TN/TT Versorgungsnetzen gestattet, die mit höchstens 16 A abgesichert sind (höhere Absicherung nur nach Rücksprache mit der Rohde & Schwarz Firmengruppe).
7. Stecken Sie den Stecker nicht in verstaubte oder verschmutzte Steckdosen/-buchsen. Stecken Sie die Steckverbindung/-vorrichtung fest und vollständig in die dafür vorgesehenen Steckdosen/-buchsen. Missachtung dieser Maßnahmen kann zu Funken, Feuer und/oder Verletzungen führen.
8. Überlasten Sie keine Steckdosen, Verlängerungskabel oder Steckdosenleisten, dies kann Feuer oder elektrische Schläge verursachen.
9. Bei Messungen in Stromkreisen mit Spannungen $U_{\text{eff}} > 30 \text{ V}$ ist mit geeigneten Maßnahmen Vorsorge zu treffen, dass jegliche Gefährdung ausgeschlossen wird (z.B. geeignete Messmittel, Absicherung, Strombegrenzung, Schutztrennung, Isolierung usw.).
10. Bei Verbindungen mit informationstechnischen Geräten, z.B. PC oder Industrierechner, ist darauf zu achten, dass diese der jeweils gültigen IEC 60950-1 / EN 60950-1 oder IEC 61010-1 / EN 61010-1 entsprechen.
11. Sofern nicht ausdrücklich erlaubt, darf der Deckel oder ein Teil des Gehäuses niemals entfernt werden, wenn das Produkt betrieben wird. Dies macht elektrische Leitungen und Komponenten zugänglich und kann zu Verletzungen, Feuer oder Schaden am Produkt führen.

Grundlegende Sicherheitshinweise

12. Wird ein Produkt ortsfest angeschlossen, ist die Verbindung zwischen dem Schutzleiteranschluss vor Ort und dem Geräteschutzleiter vor jeglicher anderer Verbindung herzustellen. Aufstellung und Anschluss darf nur durch eine Elektrofachkraft erfolgen.
13. Bei ortsfesten Geräten ohne eingebaute Sicherung, Selbstschalter oder ähnliche Schutzeinrichtung muss der Versorgungskreis so abgesichert sein, dass alle Personen, die Zugang zum Produkt haben, sowie das Produkt selbst ausreichend vor Schäden geschützt sind.
14. Jedes Produkt muss durch geeigneten Überspannungsschutz vor Überspannung (z.B. durch Blitzschlag) geschützt werden. Andernfalls ist das bedienende Personal durch elektrischen Schlag gefährdet.
15. Gegenstände, die nicht dafür vorgesehen sind, dürfen nicht in die Öffnungen des Gehäuses eingebracht werden. Dies kann Kurzschlüsse im Produkt und/oder elektrische Schläge, Feuer oder Verletzungen verursachen.
16. Sofern nicht anders spezifiziert, sind Produkte nicht gegen das Eindringen von Flüssigkeiten geschützt, siehe auch Abschnitt "Betriebszustände und Betriebslagen", Punkt 1. Daher müssen die Geräte vor Eindringen von Flüssigkeiten geschützt werden. Wird dies nicht beachtet, besteht Gefahr durch elektrischen Schlag für den Benutzer oder Beschädigung des Produkts, was ebenfalls zur Gefährdung von Personen führen kann.
17. Benutzen Sie das Produkt nicht unter Bedingungen, bei denen Kondensation in oder am Produkt stattfinden könnte oder ggf. bereits stattgefunden hat, z.B. wenn das Produkt von kalter in warme Umgebung bewegt wurde. Das Eindringen von Wasser erhöht das Risiko eines elektrischen Schlages.
18. Trennen Sie das Produkt vor der Reinigung komplett von der Energieversorgung (z.B. speisendes Netz oder Batterie). Nehmen Sie bei Geräten die Reinigung mit einem weichen, nicht fasernden Staublappen vor. Verwenden Sie keinesfalls chemische Reinigungsmittel wie z.B. Alkohol, Aceton, Nitroverdünnung.

Betrieb

1. Die Benutzung des Produkts erfordert spezielle Einweisung und hohe Konzentration während der Benutzung. Es muss sichergestellt sein, dass Personen, die das Produkt bedienen, bezüglich ihrer körperlichen, geistigen und seelischen Verfassung den Anforderungen gewachsen sind, da andernfalls Verletzungen oder Sachschäden nicht auszuschließen sind. Es liegt in der Verantwortung des Arbeitsgebers/Betreibers, geeignetes Personal für die Benutzung des Produkts auszuwählen.
2. Bevor Sie das Produkt bewegen oder transportieren, lesen und beachten Sie den Abschnitt "Transport".
3. Wie bei allen industriell gefertigten Gütern kann die Verwendung von Stoffen, die Allergien hervorrufen - so genannte Allergene (z.B. Nickel) - nicht generell ausgeschlossen werden. Sollten beim Umgang mit R&S-Produkten allergische Reaktionen, z.B. Hautausschlag, häufiges Niesen, Bindehautreizung oder Atembeschwerden auftreten, ist umgehend ein Arzt aufzusuchen, um die Ursachen zu klären und Gesundheitsschäden bzw. -belastungen zu vermeiden.
4. Vor der mechanischen und/oder thermischen Bearbeitung oder Zerlegung des Produkts beachten Sie unbedingt Abschnitt "Entsorgung", Punkt 1.

Grundlegende Sicherheitshinweise

- Bei bestimmten Produkten, z.B. HF-Funkanlagen, können funktionsbedingt erhöhte elektromagnetische Strahlungen auftreten. Unter Berücksichtigung der erhöhten Schutzwürdigkeit des ungeborenen Lebens müssen Schwangere durch geeignete Maßnahmen geschützt werden. Auch Träger von Herzschrittmachern können durch elektromagnetische Strahlungen gefährdet sein. Der Arbeitgeber/Betreiber ist verpflichtet, Arbeitsstätten, bei denen ein besonderes Risiko einer Strahlenexposition besteht, zu beurteilen und zu kennzeichnen und mögliche Gefahren abzuwenden.
- Im Falle eines Brandes entweichen ggf. giftige Stoffe (Gase, Flüssigkeiten etc.) aus dem Produkt, die Gesundheitsschäden verursachen können. Daher sind im Brandfall geeignete Maßnahmen wie z.B. Atemschutzmasken und Schutzkleidung zu verwenden.
- Falls ein Laser-Produkt in ein R&S-Produkt integriert ist (z.B. CD/DVD-Laufwerk), dürfen keine anderen Einstellungen oder Funktionen verwendet werden, als in der Produktdokumentation beschrieben, um Personenschäden zu vermeiden (z.B. durch Laserstrahl).
- EMV Klassen (nach EN 55011 / CISPR 11; sinngemäß EN 55022 / CISPR 22, EN 55032 / CISPR 32)

Gerät der Klasse A:

Ein Gerät, das sich für den Gebrauch in allen anderen Bereichen außer dem Wohnbereich und solchen Bereichen eignet, die direkt an ein Niederspannungs-Versorgungsnetz angeschlossen sind, das Wohngebäude versorgt.

Hinweis: Diese Einrichtung kann wegen möglicher auftretender leitungsgebundener als auch gestrahlter Störgrößen im Wohnbereich Funkstörungen verursachen. In diesem Fall kann vom Betreiber verlangt werden, angemessene Maßnahmen durchzuführen.

Gerät der Klasse B:

Ein Gerät, das sich für den Betrieb im Wohnbereich sowie in solchen Bereichen eignet, die direkt an ein Niederspannungs-Versorgungsnetz angeschlossen sind, das Wohngebäude versorgt.

Reparatur und Service

- Das Produkt darf nur von dafür autorisiertem Fachpersonal geöffnet werden. Vor Arbeiten am Produkt oder Öffnen des Produkts ist dieses von der Versorgungsspannung zu trennen, sonst besteht das Risiko eines elektrischen Schlages.
- Abgleich, Auswechseln von Teilen, Wartung und Reparatur darf nur von R&S-autorisierten Elektrofachkräften ausgeführt werden. Werden sicherheitsrelevante Teile (z.B. Netzschalter, Netztrafos oder Sicherungen) ausgewechselt, so dürfen diese nur durch Originalteile ersetzt werden. Nach jedem Austausch von sicherheitsrelevanten Teilen ist eine Sicherheitsprüfung durchzuführen (Sichtprüfung, Schutzleitertest, Isolationswiderstand-, Ableitstrommessung, Funktionstest). Damit wird sichergestellt, dass die Sicherheit des Produkts erhalten bleibt.

Batterien und Akkumulatoren/Zellen

Werden die Hinweise zu Batterien und Akkumulatoren/Zellen nicht oder unzureichend beachtet, kann dies Explosion, Brand und/oder schwere Verletzungen von Personen, unter Umständen mit Todesfolge, verursachen. Die Handhabung von Batterien und Akkumulatoren mit alkalischen Elektrolyten (z.B. Lithiumzellen) muss der EN 62133 entsprechen.

- Zellen dürfen nicht zerlegt, geöffnet oder zerkleinert werden.
- Zellen oder Batterien dürfen weder Hitze noch Feuer ausgesetzt werden. Die Lagerung im direkten Sonnenlicht ist zu vermeiden. Zellen und Batterien sauber und trocken halten. Verschmutzte Anschlüsse mit einem trockenen, sauberen Tuch reinigen.

Grundlegende Sicherheitshinweise

3. Zellen oder Batterien dürfen nicht kurzgeschlossen werden. Zellen oder Batterien dürfen nicht gefahrbringend in einer Schachtel oder in einem Schubfach gelagert werden, wo sie sich gegenseitig kurzschließen oder durch andere leitende Werkstoffe kurzgeschlossen werden können. Eine Zelle oder Batterie darf erst aus ihrer Originalverpackung entnommen werden, wenn sie verwendet werden soll.
4. Zellen oder Batterien dürfen keinen unzulässig starken, mechanischen Stößen ausgesetzt werden.
5. Bei Undichtheit einer Zelle darf die Flüssigkeit nicht mit der Haut in Berührung kommen oder in die Augen gelangen. Falls es zu einer Berührung gekommen ist, den betroffenen Bereich mit reichlich Wasser waschen und ärztliche Hilfe in Anspruch nehmen.
6. Werden Zellen oder Batterien, die alkalische Elektrolyte enthalten (z.B. Lithiumzellen), unsachgemäß ausgewechselt oder geladen, besteht Explosionsgefahr. Zellen oder Batterien nur durch den entsprechenden R&S-Typ ersetzen (siehe Ersatzteilliste), um die Sicherheit des Produkts zu erhalten.
7. Zellen oder Batterien müssen wiederverwertet werden und dürfen nicht in den Restmüll gelangen. Akkumulatoren oder Batterien, die Blei, Quecksilber oder Cadmium enthalten, sind Sonderabfall. Beachten Sie hierzu die landesspezifischen Entsorgungs- und Recycling-Bestimmungen.

Transport

1. Das Produkt kann ein hohes Gewicht aufweisen. Daher muss es vorsichtig und ggf. unter Verwendung eines geeigneten Hebemittels (z.B. Hubwagen) bewegt bzw. transportiert werden, um Rückenschäden oder Verletzungen zu vermeiden.
2. Griffe an den Produkten sind eine Handhabungshilfe, die ausschließlich für den Transport des Produkts durch Personen vorgesehen ist. Es ist daher nicht zulässig, Griffe zur Befestigung an bzw. auf Transportmitteln, z.B. Kränen, Gabelstaplern, Karren etc. zu verwenden. Es liegt in Ihrer Verantwortung, die Produkte sicher an bzw. auf geeigneten Transport- oder Hebemitteln zu befestigen. Beachten Sie die Sicherheitsvorschriften des jeweiligen Herstellers eingesetzter Transport- oder Hebemittel, um Personenschäden und Schäden am Produkt zu vermeiden.
3. Falls Sie das Produkt in einem Fahrzeug benutzen, liegt es in der alleinigen Verantwortung des Fahrers, das Fahrzeug in sicherer und angemessener Weise zu führen. Der Hersteller übernimmt keine Verantwortung für Unfälle oder Kollisionen. Verwenden Sie das Produkt niemals in einem sich bewegenden Fahrzeug, sofern dies den Fahrzeugführer ablenken könnte. Sichern Sie das Produkt im Fahrzeug ausreichend ab, um im Falle eines Unfalls Verletzungen oder Schäden anderer Art zu verhindern.

Entsorgung

1. Batterien bzw. Akkumulatoren, die nicht mit dem Hausmüll entsorgt werden dürfen, darf nach Ende der Lebensdauer nur über eine geeignete Sammelstelle oder eine Rohde & Schwarz-Kundendienststelle entsorgt werden.
2. Am Ende der Lebensdauer des Produktes darf dieses Produkt nicht über den normalen Hausmüll entsorgt werden, sondern muss getrennt gesammelt werden. Rohde & Schwarz GmbH & Co.KG ein Entsorgungskonzept entwickelt und übernimmt die Pflichten der Rücknahme- und Entsorgung für Hersteller innerhalb der EU in vollem Umfang. Wenden Sie sich bitte an Ihre Rohde & Schwarz-Kundendienststelle, um das Produkt umweltgerecht zu entsorgen.

Grundlegende Sicherheitshinweise

3. Werden Produkte oder ihre Bestandteile über den bestimmungsgemäßen Betrieb hinaus mechanisch und/oder thermisch bearbeitet, können ggf. gefährliche Stoffe (schwermetallhaltiger Staub wie z.B. Blei, Beryllium, Nickel) freigesetzt werden. Die Zerlegung des Produkts darf daher nur von speziell geschultem Fachpersonal erfolgen. Unsachgemäßes Zerlegen kann Gesundheitsschäden hervorrufen. Die nationalen Vorschriften zur Entsorgung sind zu beachten.
4. Falls beim Umgang mit dem Produkt Gefahren- oder Betriebsstoffe entstehen, die speziell zu entsorgen sind, z.B. regelmäßig zu wechselnde Kühlmittel oder Motorenöle, sind die Sicherheitshinweise des Herstellers dieser Gefahren- oder Betriebsstoffe und die regional gültigen Entsorgungsvorschriften einzuhalten. Beachten Sie ggf. auch die zugehörigen speziellen Sicherheitshinweise in der Produktdokumentation. Die unsachgemäße Entsorgung von Gefahren- oder Betriebsstoffen kann zu Gesundheitsschäden von Personen und Umweltschäden führen.

Weitere Informationen zu Umweltschutz finden Sie auf der Rohde & Schwarz Home Page.

Consignes de sécurité fondamentales

Lisez et respectez impérativement les instructions et consignes de sécurité suivantes

Les usines et sites du groupe Rohde & Schwarz veillent à la conformité des produits du groupe avec les normes de sécurité en vigueur dans un souci constant de garantir aux clients le plus haut niveau de sécurité possible. Nos produits ainsi que les accessoires nécessaires sont fabriqués et testés conformément aux règles de sécurité en vigueur. Le respect de ces règles est vérifié régulièrement par notre système d'assurance qualité. Le présent produit a été fabriqué et contrôlé conformément au certificat de conformité CE ci-joint et a quitté l'usine dans un parfait état de sécurité. Pour le maintenir dans cet état et en garantir une utilisation sans danger, l'utilisateur doit respecter l'ensemble des consignes, remarques de sécurité et avertissements qui se trouvent dans ce manuel. Le groupe Rohde & Schwarz se tient à votre disposition pour toutes questions relatives aux présentes consignes de sécurité.

















Il incombe à l'utilisateur d'employer ce produit de manière appropriée. Le produit est exclusivement destiné à l'utilisation en industrie et en laboratoire et/ou, si cela a été expressément autorisé, également aux travaux extérieurs ; il ne peut en aucun cas être utilisé à des fins pouvant causer des dommages corporels ou matériels. L'exploitation du produit en dehors de son utilisation prévue ou le non-respect des consignes du fabricant se font sous la responsabilité de l'utilisateur. Le fabricant décline toute responsabilité en cas d'utilisation non conforme du produit.

Le produit est présumé faire l'objet d'une utilisation conforme lorsqu'il est utilisé conformément aux consignes de la documentation produit correspondante et dans la limite de ses performances (voir fiche technique, documentation, consignes de sécurité ci-après). L'utilisation du produit exige des compétences en la matière et des connaissances de base de l'anglais. Par conséquent, le produit ne devra être utilisé que par un personnel qualifié ou des personnes formées de manière approfondie et possédant les compétences requises. Si, pour l'utilisation des produits Rohde & Schwarz, l'emploi d'un équipement personnel de protection s'avère nécessaire, il en est fait mention dans la documentation produit à l'emplacement correspondant. Conservez les consignes de sécurité fondamentales et la documentation produit dans un lieu sûr et transmettez ces documents aux autres utilisateurs du produit.

La stricte observation des consignes de sécurité a pour but d'exclure des blessures ou dommages causés par des dangers de toutes sortes. A cet effet, il est nécessaire de lire avec soin et de bien comprendre les consignes de sécurité ci-dessous avant l'utilisation du produit et de les respecter lors de l'utilisation du produit. Toutes les autres consignes de sécurité présentées à l'emplacement correspondant de la documentation produit, par exemple, celles concernant la protection des personnes, doivent également être impérativement respectées. Dans les présentes consignes de sécurité, toutes les marchandises commercialisées par le groupe Rohde & Schwarz, notamment les appareils, les systèmes ainsi que les accessoires, sont dénommés « produit ».

Consignes de sécurité fondamentales

Symboles et marquages de sécurité

Symbole	Signification	Symbole	Signification
	Avis, source générale de danger Se référer à la documentation produit		MARCHE / ARRET (tension d'alimentation)
	Attention lors de la manipulation d'appareils ayant un poids élevé		Indicateur de veille
	Risque de choc électrique		Courant continu (CC)
	Avertissement, surface chaude		Courant alternatif (CA)
	Borne de conducteur de protection		Courant continu/alternatif (CC/CA)
	Borne de mise à la terre		L'appareil est conforme aux exigences de sécurité du degré de protection II (appareil entièrement protégé par isolation double/renforcée).
	Borne de mise à la masse du bâti ou du boîtier		Marquage UE pour batteries et accumulateurs. L'appareil contient une batterie ou un accumulateur. Ces pièces ne peuvent pas être éliminées avec les déchets urbains non triés, mais doivent faire l'objet d'une collecte séparée. Pour plus d'informations, voir la page 7.
	Avis : prudence lors de la manipulation de composants sensibles aux décharges électrostatiques		Marquage UE pour la collecte séparée d'équipements électriques et électroniques. Les déchets d'équipements électriques et électroniques ne peuvent pas être éliminés avec les déchets urbains non triés, mais doivent faire l'objet d'une collecte séparée. Pour plus d'informations, voir la page 7.
	Avertissement, rayon laser Les produits laser sont munis d'avertissements normalisés d'après leur catégorie laser. En raison des caractéristiques de leur rayonnement ainsi que de leur puissance électromagnétique extrêmement concentrée, les lasers peuvent causer des dommages biologiques. Pour plus d'informations, voir le chapitre « Fonctionnement », point 7.		

Consignes de sécurité fondamentales

Mots d'alerte et significations

Les mots d'alerte suivants sont utilisés dans la documentation produit pour avertir des risques et dangers.



Indique une situation dangereuse immédiate qui, si elle n'est pas évitée, comporte un risque élevé de blessures graves ou mortelles.



Indique une situation dangereuse possible qui, si elle n'est pas évitée, comporte un risque modéré de blessures (graves) ou mortelles.



Indique une situation dangereuse qui, si elle n'est pas évitée, comporte un risque faible de blessures mineures ou modérées.



Indique la possibilité d'une fausse manœuvre susceptible d'endommager le produit.

Ces mots d'alerte correspondent à la définition habituelle utilisée pour des applications civiles dans l'espace économique européen. Des définitions divergentes peuvent cependant exister dans d'autres espaces économiques ou dans le cadre d'applications militaires. Il faut donc veiller à ce que les mots d'alerte décrits ici ne soient utilisés qu'en relation avec la documentation produit correspondante et seulement avec le produit correspondant. L'utilisation des mots d'alerte en relation avec des produits ou des documentations non correspondants peut conduire à des erreurs d'interprétation et par conséquent à des dommages corporels ou matériels.

États et positions de fonctionnement

L'appareil ne doit être utilisé que dans les états et positions de fonctionnement indiqués par le fabricant. Tout obstacle à la ventilation doit être empêché. Le non-respect des indications du fabricant peut provoquer des chocs électriques, des incendies et/ou des blessures graves pouvant éventuellement entraîner la mort. Pour tous les travaux, les règles locales et/ou nationales de sécurité et de prévention des accidents doivent être respectées.

1. Sauf stipulations contraires, les produits Rohde & Schwarz répondent aux exigences ci-après : faire fonctionner le produit avec le fond du boîtier toujours en bas, degré de protection IP 2X, degré de pollution 2, catégorie de surtension 2, utilisation uniquement à l'intérieur, fonctionnement à une altitude max. de 2000 m au-dessus du niveau de la mer, transport à une altitude max. de 4500 m au-dessus du niveau de la mer, tolérance de $\pm 10\%$ pour la tension nominale et de $\pm 5\%$ pour la fréquence nominale.
2. Ne jamais placer le produit sur des surfaces, véhicules, dépôts ou tables non appropriés pour raisons de stabilité ou de poids. Suivre toujours strictement les indications d'installation du fabricant pour le montage et la fixation du produit sur des objets ou des structures (par exemple parois et étagères). En cas d'installation non conforme à la documentation produit, il y a risque de blessures, voire de mort.
3. Ne jamais placer le produit sur des dispositifs générant de la chaleur (par exemple radiateurs et appareils de chauffage soufflants). La température ambiante ne doit pas dépasser la température maximale spécifiée dans la documentation produit ou dans la fiche technique. Une surchauffe du produit peut provoquer des chocs électriques, des incendies et/ou des blessures graves pouvant éventuellement entraîner la mort.

Consignes de sécurité fondamentales

Sécurité électrique

Si les consignes relatives à la sécurité électrique ne sont pas ou sont insuffisamment respectées, il peut s'ensuivre des chocs électriques, des incendies et/ou des blessures graves pouvant éventuellement entraîner la mort.

1. Avant chaque mise sous tension du produit, il faut s'assurer que la tension nominale réglée sur le produit correspond à la tension nominale du réseau électrique. S'il est nécessaire de modifier le réglage de la tension, il faut remplacer le fusible du produit, le cas échéant.
2. L'utilisation des produits du degré de protection I pourvus d'un câble d'alimentation mobile et d'un connecteur n'est autorisée qu'avec des prises munies d'un contact de protection et d'un conducteur de protection raccordé.
3. Toute déconnexion intentionnelle du conducteur de protection, dans le câble ou dans le produit lui-même, est interdite. Elle entraîne un risque de choc électrique au niveau du produit. En cas d'utilisation de câbles prolongateurs ou de multiprises, ceux-ci doivent être examinés régulièrement quant à leur état de sécurité technique.
4. Si le produit n'est pas doté d'un interrupteur d'alimentation pour le couper du réseau électrique ou si l'interrupteur d'alimentation disponible n'est pas approprié pour couper le produit du réseau électrique, le connecteur mâle du câble de raccordement est à considérer comme dispositif de séparation. Le dispositif de séparation doit être à tout moment facilement accessible. Si, par exemple, le connecteur d'alimentation sert de dispositif de séparation, la longueur du câble de raccordement ne doit pas dépasser 3 m.
Les commutateurs fonctionnels ou électroniques ne sont pas appropriés pour couper l'appareil du réseau électrique. Si des produits sans interrupteur d'alimentation sont intégrés dans des bâtis ou systèmes, le dispositif de séparation doit être reporté au niveau du système.
5. Ne jamais utiliser le produit si le câble d'alimentation est endommagé. Vérifier régulièrement le parfait état du câble d'alimentation. Prendre les mesures préventives appropriées et opter pour des types de pose tels que le câble d'alimentation ne puisse pas être endommagé et que personne ne puisse subir de préjudice, par exemple en trébuchant sur le câble ou par des chocs électriques.
6. L'utilisation des produits est uniquement autorisée sur des réseaux d'alimentation de type TN/TT protégés par des fusibles d'une intensité max. de 16 A (pour toute intensité supérieure, consulter le groupe Rohde & Schwarz).
7. Ne pas brancher le connecteur dans des prises d'alimentation sales ou poussiéreuses. Enfoncer fermement le connecteur jusqu'au bout de la prise. Le non-respect de cette mesure peut provoquer des étincelles, incendies et/ou blessures.
8. Ne pas surcharger les prises, les câbles prolongateurs ou les multiprises, cela pouvant provoquer des incendies ou chocs électriques.
9. En cas de mesures sur les circuits électriques d'une tension efficace > 30 V, prendre les précautions nécessaires pour éviter tout risque (par exemple équipement de mesure approprié, fusibles, limitation de courant, coupe-circuit, isolation, etc.).
10. En cas d'interconnexion avec des équipements informatiques comme par exemple un PC ou un ordinateur industriel, veiller à ce que ces derniers soient conformes aux normes IEC 60950-1 / EN 60950-1 ou IEC 61010-1 / EN 61010-1 en vigueur.
11. Sauf autorisation expresse, il est interdit de retirer le couvercle ou toute autre pièce du boîtier lorsque le produit est en cours de service. Les câbles et composants électriques seraient ainsi accessibles, ce qui peut entraîner des blessures, des incendies ou des dégâts sur le produit.

Consignes de sécurité fondamentales

12. Si un produit est connecté de façon stationnaire, établir avant toute autre connexion le raccordement du conducteur de protection local et du conducteur de protection du produit. L'installation et le raccordement ne peuvent être effectués que par un électricien ou électronicien qualifié.
13. Sur les appareils stationnaires sans fusible ni disjoncteur automatique ou dispositif de protection similaire intégrés, le circuit d'alimentation doit être sécurisé de sorte que toutes les personnes ayant accès au produit et le produit lui-même soient suffisamment protégés contre tout dommage.
14. Chaque produit doit être protégé de manière appropriée contre les éventuelles surtensions (par exemple dues à un coup de foudre). Sinon, les utilisateurs sont exposés à des risques de choc électrique.
15. Ne jamais introduire d'objets non prévus à cet effet dans les ouvertures du boîtier, étant donné que cela peut entraîner des courts-circuits dans le produit et/ou des chocs électriques, incendies ou blessures.
16. Sauf spécification contraire, les produits ne sont pas protégés contre l'infiltration de liquides, voir aussi la section « États et positions de fonctionnement », point 1. Il faut donc protéger les produits contre l'infiltration de liquides. La non-observation de cette consigne entraîne le risque de choc électrique pour l'utilisateur ou d'endommagement du produit, ce qui peut également mettre les personnes en danger.
17. Ne pas utiliser le produit dans des conditions pouvant occasionner ou ayant déjà occasionné, le cas échéant, des condensations dans ou sur le produit, par exemple lorsque celui-ci est déplacé d'un environnement froid dans un environnement chaud. L'infiltration d'eau augmente le risque de choc électrique.
18. Avant le nettoyage, débrancher le produit de l'alimentation (par exemple réseau électrique ou batterie). Pour le nettoyage des appareils, utiliser un chiffon doux non pelucheux. N'utiliser en aucun cas de produit de nettoyage chimique, tel que de l'alcool, de l'acétone ou un diluant nitrocellulosique.

Fonctionnement

1. L'utilisation du produit exige une formation spécifique ainsi qu'une grande concentration. Il est impératif que les personnes qui utilisent le produit présentent les aptitudes physiques, mentales et psychiques requises, vu qu'autrement des dommages corporels ou matériels ne peuvent pas être exclus. Le choix du personnel qualifié pour l'utilisation du produit est sous la responsabilité de l'employeur/l'exploitant.
2. Avant de déplacer ou de transporter le produit, lire et respecter la section « Transport ».
3. Comme pour tous les biens produits de façon industrielle, l'utilisation de matériaux pouvant causer des allergies (allergènes, comme par exemple le nickel) ne peut être totalement exclue. Si, lors de l'utilisation de produits Rohde & Schwarz, des réactions allergiques surviennent, telles qu'éruption cutanée, éternuements fréquents, rougeur de la conjonctive ou difficultés respiratoires, il faut immédiatement consulter un médecin pour en clarifier la cause et éviter toute atteinte à la santé.
4. Avant le traitement mécanique et/ou thermique ou le démontage du produit, il faut impérativement observer la section « Élimination des déchets », point 1.

Consignes de sécurité fondamentales

5. Selon les fonctions, certains produits, tels que des systèmes de radiocommunication RF, peuvent produire des niveaux élevés de rayonnement électromagnétique. Étant donné la vulnérabilité de l'enfant à naître, les femmes enceintes doivent être protégées par des mesures appropriées. Les porteurs de stimulateurs cardiaques peuvent également être menacés par les rayonnements électromagnétiques. L'employeur/l'exploitant est tenu d'évaluer et de repérer les lieux de travail soumis à un risque particulier d'exposition aux rayonnements et de prévenir les dangers éventuels.
6. En cas d'incendie, il se peut que le produit dégage des matières toxiques (gaz, liquides, etc.) susceptibles de nuire à la santé. Il faut donc, en cas d'incendie, prendre des mesures adéquates comme par exemple le port de masques respiratoires et de vêtements de protection.
7. Si un produit laser est intégré dans un produit Rohde & Schwarz (par exemple lecteur CD/DVD), il ne faut pas utiliser de réglages ou fonctions autres que ceux décrits dans la documentation produit pour éviter tout dommage corporel (par exemple causé par rayon laser).
8. Classes CEM (selon EN 55011 / CISPR 11 ; selon EN 55022 / CISPR 22, EN 55032 / CISPR 32 par analogie)
 - Appareil de la classe A :
Appareil approprié à un usage dans tous les environnements autres que l'environnement résidentiel et les environnements raccordés directement à un réseau d'alimentation basse tension qui alimente des bâtiments résidentiels.
Remarque : ces appareils peuvent provoquer des perturbations radioélectriques dans l'environnement résidentiel en raison de perturbations conduites ou rayonnées. Dans ce cas, on peut exiger que l'exploitant mette en œuvre de mesures appropriées pour éliminer ces perturbations.
 - Appareil de la classe B :
Appareil approprié à un usage dans l'environnement résidentiel ainsi que dans les environnements raccordés directement à un réseau d'alimentation basse tension qui alimente des bâtiments résidentiels.

Réparation et service après-vente

1. Le produit ne doit être ouvert que par un personnel qualifié et autorisé. Avant de travailler sur le produit ou de l'ouvrir, il faut le couper de la tension d'alimentation ; sinon il y a risque de choc électrique.
2. Les travaux d'ajustement, le remplacement des pièces, la maintenance et la réparation ne doivent être effectués que par des électroniciens qualifiés et autorisés par Rohde & Schwarz. En cas de remplacement de pièces concernant la sécurité (notamment interrupteur d'alimentation, transformateur d'alimentation réseau ou fusibles), celles-ci ne doivent être remplacées que par des pièces d'origine. Après chaque remplacement de pièces concernant la sécurité, une vérification de sécurité doit être effectuée (contrôle visuel, vérification du conducteur de protection, mesure de la résistance d'isolement et du courant de fuite, essai de fonctionnement). Cela permet d'assurer le maintien de la sécurité du produit.

Batteries et accumulateurs/cellules

Si les instructions concernant les batteries et accumulateurs/cellules ne sont pas ou sont insuffisamment respectées, cela peut provoquer des explosions, des incendies et/ou des blessures graves pouvant entraîner la mort. La manipulation de batteries et accumulateurs contenant des électrolytes alcalins (par exemple cellules de lithium) doit être conforme à la norme EN 62133.

Consignes de sécurité fondamentales

1. Les cellules ne doivent être ni démontées, ni ouvertes, ni réduites en morceaux.
2. Ne jamais exposer les cellules ou batteries à la chaleur ou au feu. Ne pas les stocker dans un endroit où elles sont exposées au rayonnement direct du soleil. Tenir les cellules et batteries au sec. Nettoyer les raccords sales avec un chiffon sec et propre.
3. Ne jamais court-circuiter les cellules ou batteries. Les cellules ou batteries ne doivent pas être gardées dans une boîte ou un tiroir où elles peuvent se court-circuiter mutuellement ou être court-circuitées par d'autres matériaux conducteurs. Une cellule ou batterie ne doit être retirée de son emballage d'origine que lorsqu'on l'utilise.
4. Les cellules ou batteries ne doivent pas être exposées à des chocs mécaniques de force non admissible.
5. En cas de manque d'étanchéité d'une cellule, le liquide ne doit pas entrer en contact avec la peau ou les yeux. S'il y a contact, rincer abondamment à l'eau l'endroit concerné et consulter un médecin.
6. Il y a danger d'explosion en cas de remplacement ou chargement incorrect des cellules ou batteries qui contiennent des électrolytes alcalins (par exemple cellules de lithium). Remplacer les cellules ou batteries uniquement par le type Rohde & Schwarz correspondant (voir la liste des pièces de rechange) pour maintenir la sécurité du produit.
7. Il faut recycler les cellules ou batteries et il est interdit de les éliminer comme déchets normaux. Les accumulateurs ou batteries qui contiennent du plomb, du mercure ou du cadmium sont des déchets spéciaux. Observer les règles nationales d'élimination et de recyclage.

Transport

1. Le produit peut avoir un poids élevé. Il faut donc le déplacer ou le transporter avec précaution et en utilisant le cas échéant un moyen de levage approprié (par exemple, chariot élévateur) pour éviter des dommages au dos ou des blessures.
2. Les poignées des produits sont une aide de manipulation exclusivement réservée au transport du produit par des personnes. Il est donc proscrit d'utiliser ces poignées pour attacher le produit à ou sur des moyens de transport, tels que grues, chariots et chariots élévateurs, etc. Vous êtes responsable de la fixation sûre des produits à ou sur des moyens de transport et de levage appropriés. Observer les consignes de sécurité du fabricant des moyens de transport ou de levage utilisés pour éviter des dommages corporels et des dégâts sur le produit.
3. L'utilisation du produit dans un véhicule se fait sous l'unique responsabilité du conducteur qui doit piloter le véhicule de manière sûre et appropriée. Le fabricant décline toute responsabilité en cas d'accidents ou de collisions. Ne jamais utiliser le produit dans un véhicule en mouvement si cela pouvait détourner l'attention du conducteur. Sécuriser suffisamment le produit dans le véhicule pour empêcher des blessures ou dommages de tout type en cas d'accident.

Élimination des déchets

1. Au terme de leur durée de vie, les batteries ou accumulateurs qui ne peuvent pas être éliminés avec les déchets ménagers peuvent uniquement être éliminés par des points de collecte appropriés ou par un centre de service après-vente Rohde & Schwarz.

Consignes de sécurité fondamentales

2. Au terme de sa durée de vie, un produit ne peut pas être éliminé avec les déchets ménagers normaux, mais doit être collecté séparément.
Rohde & Schwarz GmbH & Co. KG a développé un concept d'élimination des déchets et assume toutes les obligations en matière de reprise et d'élimination, valables pour les fabricants au sein de l'UE. Veuillez vous adresser à votre centre de service après-vente Rohde & Schwarz pour éliminer le produit de manière écologique.
3. Si les produits ou leurs composants sont travaillés mécaniquement et/ou thermiquement au-delà de l'utilisation prévue, ils peuvent, le cas échéant, libérer des substances dangereuses (poussières contenant des métaux lourds comme par exemple du plomb, du béryllium ou du nickel). Le démontage du produit ne doit donc être effectué que par un personnel qualifié et spécialement formé. Le démontage inadéquat peut nuire à la santé. Les règles nationales concernant l'élimination des déchets doivent être observées.
4. Si, lors de l'utilisation du produit, des substances dangereuses ou combustibles exigeant une élimination spéciale sont dégagées, comme par exemple liquides de refroidissement ou huiles moteurs qui sont à changer régulièrement, les consignes de sécurité du fabricant de ces substances dangereuses ou combustibles ainsi que les règles sur l'élimination en vigueur au niveau régional doivent être respectées. Les consignes de sécurité spéciales correspondantes dans la documentation produit doivent également être respectées, le cas échéant. L'élimination non conforme des substances dangereuses ou combustibles peut provoquer des atteintes à la santé et des dommages écologiques.

Pour plus d'informations concernant la protection de l'environnement, voir la page d'accueil de Rohde & Schwarz.

Safety instructions for rechargeable lithium ion batteries

WARNING

Risk of serious personal injury or even death.

You must fully observe the following instructions in order to avoid serious personal injury – or even death – due to an explosion and/or fire.

1. Do not dismantle, open or crush the batteries or drop them from a great height. If mechanical damage occurs, there is a risk that chemicals may be released. Gases that are released can cause breathing difficulties. Immediately ventilate the area and in serious cases consult a doctor.
Irritation can occur if the chemicals that are released come in contact with the skin or eyes. If this happens, immediately and thoroughly rinse the skin or eyes with water and consult a doctor.
2. Do not expose cells or batteries to heat or fire. Do not store them in direct sunlight. If overheating occurs, there is the risk of an explosion or a fire, which can lead to serious personal injuries.
3. Keep the batteries clean and dry. If the terminals become soiled, clean them with a dry, clean cloth.
4. Charge the batteries prior to using them.
Only use the appropriate Rohde & Schwarz charger to charge the batteries. See the device manual or data sheet for the exact designation of the charger.
If the batteries are improperly charged, there is a risk of explosion, which can cause serious personal injury.
5. The charging temperature must be between 0 °C and 45 °C
(see manual for information on possible restrictions).
6. Discharging may take place only at temperatures between 0 °C and 50 °C
(see manual for information on possible restrictions).
7. Only charge batteries until they are fully charged. Frequent overcharging can reduce the battery lifetime.
8. Remove the battery from the device when the battery is not being used. Following a longer period of storage, it may be necessary to charge and discharge the battery several times in order to obtain the full capacity.
9. Only use the battery with designated Rohde & Schwarz devices. See the device manual for details.
10. Do not dispose of the batteries with unsorted municipal waste. The batteries must be collected separately. After the end of their life, dispose of the batteries at a suitable collection point or via a Rohde & Schwarz customer service center.



EU labeling for batteries and secondary cells

11. Keep this safety information for future reference.

Instrucciones de seguridad para baterías recargables de ión litio

⚠ ADVERTENCIA

Posibilidad de lesiones graves que en determinadas circunstancias puede causar la muerte.

Tenga en cuenta los siguientes avisos en caso de explosión y/o incendio para impedir lesiones graves en personas que, en determinadas circunstancias, podrían incluso causar la muerte.

1. No desarme las baterías, no las abra, no las triture ni las deje caer desde una gran altura.
En caso de daños mecánicos existe el riesgo de salida de sustancias químicas. En caso de salida de gases pueden producirse dificultades respiratorias. Ventile inmediatamente la habitación y acuda a un médico en casos graves.
Si sustancias químicas provenientes de la batería entran en contacto con la piel o los ojos pueden producirse irritaciones. Enjuague en estos casos la piel y los ojos inmediatamente con abundante agua y acuda a un médico.
2. No exponga las celdas o baterías al calor ni al fuego. No las almacene bajo la luz solar directa. En caso de sobrecalentamiento existe peligro de explosión o de incendio, lo que puede provocar lesiones graves en personas.
3. Mantenga las baterías limpias y secas. Si los conectores están sucios, límpielos con un paño seco y limpio.
4. Cargue las baterías antes de su uso.
Solamente está permitido cargar la batería con el correspondiente cargador de Rohde & Schwarz. Consulte en el manual o en las especificaciones técnicas del equipo la denominación exacta del cargador.
Si las baterías se cargan de forma incorrecta existe peligro de explosión, lo que podría causar lesiones graves en personas.
5. La temperatura de carga debe encontrarse entre 0 °C y 45 °C (consulte el manual para posibles restricciones).
6. La descarga solamente puede efectuarse entre 0 °C y 50°C (consulte el manual para posibles restricciones).
7. Cargue las baterías solamente el tiempo necesario hasta que se hayan cargado por completo. La sobrecarga frecuente reduce la vida útil de la batería.
8. Extraiga la batería del equipo si no se va a utilizar. Después de un periodo de almacenamiento prolongado puede ser necesario cargar y descargar varias veces la batería para recuperar su capacidad completa.
9. Utilice la batería exclusivamente con los equipos Rohde & Schwarz correspondientes. Consulte para ello el manual del equipo.
10. No elimine las baterías junto con los residuos urbanos sin clasificar, sino por separado. Para eliminar la batería una vez finalizada su vida útil, diríjase a un punto de recogida de residuos adecuado o a una oficina de representación de Rohde & Schwarz.



Etiquetado de la UE para baterías y acumuladores

11. Conserve estas instrucciones de seguridad para fines de información y consulta posterior.

Sicherheitshinweise für wiederaufladbare Li-Ion-Batterien

WARNUNG

Mögliche schwere Verletzungen, unter Umständen mit Todesfolge.

Beachten Sie die folgenden Hinweise vollständig, um schwere Verletzungen von Personen - unter Umständen mit Todesfolge - durch Explosion und/oder Brand zu verhindern.

1. Batterien nicht zerlegen, öffnen, zerkleinern oder aus großer Höhe fallen lassen. Bei mechanischer Beschädigung besteht die Gefahr des Austritts von Chemikalien. Austretende Gase können zu Atembeschwerden führen. Sofort lüften, in schweren Fällen einen Arzt konsultieren.
Bei Haut- oder Augenkontakt mit austretenden Chemikalien können Hautirritationen und Reizungen auftreten. In diesen Fällen die Haut oder Augen sofort gründlich mit Wasser ausspülen und einen Arzt konsultieren.
2. Zellen oder Batterien weder Hitze noch Feuer aussetzen. Nicht im direkten Sonnenlicht lagern. Bei Überhitzung besteht die Gefahr einer Explosion oder eines Brandes, was zu schweren Verletzungen bei Personen führen kann.
3. Batterien sauber und trocken halten. Falls die Anschlüsse verschmutzt sind, mit einem trockenen, sauberen Tuch reinigen.
4. Batterien vor dem Gebrauch laden.
Die Batterie darf ausschließlich mit dem entsprechenden Rohde & Schwarz Ladegerät geladen werden. Siehe Handbuch oder Datenblatt des Gerätes für die genaue Bezeichnung des Ladegerätes.
Wenn Batterien unsachgemäß geladen werden, besteht Explosionsgefahr, was zu schweren Verletzungen bei Personen führen kann.
5. Die Ladetemperatur muss zwischen 0 °C und 45 °C betragen (für mögliche Einschränkungen siehe Handbuch).
6. Ein Entladen darf nur zwischen 0 °C und 50 °C erfolgen (für mögliche Einschränkungen siehe Handbuch).
7. Batterien nur so lange laden, bis sie vollständig aufgeladen sind. Ein häufiges Überladen führt zu einer geringeren Lebensdauer der Batterie.
8. Die Batterie aus dem Gerät entfernen, wenn sie nicht benutzt wird. Nach längerer Lagerzeit kann es erforderlich sein, die Batterie mehrmals zu laden und zu entladen, um die volle Leistungsfähigkeit zu erlangen.
9. Die Batterie nur mit dafür vorgesehenen Rohde & Schwarz-Geräten betreiben. Siehe dazu das Handbuch des Gerätes.
10. Die Batterien nicht über unsortierten Siedlungsabfall entsorgen, sondern getrennt sammeln. Nach Ende der Lebensdauer über eine geeignete Sammelstelle oder eine Rohde&Schwarz-Kundendienststelle entsorgen.



EU - Kennzeichnung für Batterien und Akkumulatoren

11. Diese Sicherheitsinformationen für zukünftige Informations- und Nachschlagezwecke aufbewahren.

Consignes de sécurité pour batteries rechargeables lithium-ion

⚠ AVERTISSEMENT

Risque de blessures graves pouvant entraîner la mort.

Respecter intégralement les consignes ci-dessous afin d'éliminer tout risque de blessures graves voire mortelles par suite d'explosion et/ou d'incendie.

1. Ne pas démonter, ouvrir ou découper les batteries ni les faire tomber d'une hauteur importante. Des produits chimiques peuvent s'écouler en cas de détérioration mécanique et les gaz libérés peuvent provoquer des difficultés respiratoires. Aérer immédiatement les locaux. Dans les cas graves, consulter un médecin. Si la peau ou les yeux entrent en contact avec les produits chimiques libérés, des irritations peuvent se produire. Rincer immédiatement et abondamment la peau ou les yeux à l'eau claire et consulter un médecin.
2. Ne pas exposer les cellules ou les batteries à la chaleur ou au feu. Ne pas les stocker dans un endroit exposé à la lumière directe du soleil. Toute surchauffe risque de provoquer une explosion ou un incendie, ce qui peut entraîner des blessures graves.
3. Conserver les batteries dans un lieu sec et propre. Nettoyer les points de contact sales à l'aide d'un chiffon sec et propre.
4. Charger les batteries avant utilisation. Utiliser seulement le chargeur Rohde & Schwarz approprié pour recharger les batteries. Les références exactes du chargeur sont indiquées dans le manuel ou la fiche technique de l'appareil. Une recharge incorrecte des batteries peut entraîner des explosions susceptibles de causer des blessures graves.
5. Recharger impérativement à des températures comprises entre 0 °C et 45 °C (restrictions éventuelles : voir le manuel).
6. Décharger impérativement à des températures comprises entre 0 °C et 50 °C (restrictions éventuelles : voir le manuel).
7. Terminer la charge dès que les batteries sont complètement rechargées. Une surcharge répétée diminue la longévité des batteries.
8. Retirer les batteries de l'appareil lorsqu'elles ne sont pas utilisées. Après un stockage prolongé, plusieurs cycles de recharge et de décharge peuvent s'avérer nécessaires pour rétablir la pleine capacité des batteries.
9. Utiliser les batteries exclusivement dans les appareils Rohde & Schwarz auxquels elles sont destinées. Voir le manuel fourni avec chaque appareil.
10. Ne pas éliminer les batteries avec les déchets municipaux non triés mais s'assurer qu'elles soient collectées séparément. Recycler les batteries en fin de vie en les confiant à un point de collecte compétent ou à un point de service après-vente Rohde & Schwarz.



Marquage UE pour batteries et accumulateurs

11. Conserver ces consignes de sécurité de sorte à pouvoir vous y reporter ou vérifier ultérieurement certains points.

Customer Support

Technical support – where and when you need it

For quick, expert help with any Rohde & Schwarz equipment, contact one of our Customer Support Centers. A team of highly qualified engineers provides telephone support and will work with you to find a solution to your query on any aspect of the operation, programming or applications of Rohde & Schwarz equipment.

Up-to-date information and upgrades

To keep your instrument up-to-date and to be informed about new application notes related to your instrument, please send an e-mail to the Customer Support Center stating your instrument and your wish. We will take care that you will get the right information.

Europe, Africa, Middle East

Phone +49 89 4129 12345
customersupport@rohde-schwarz.com

North America

Phone 1-888-TEST-RSA (1-888-837-8772)
customer.support@rsa.rohde-schwarz.com

Latin America

Phone +1-410-910-7988
customersupport.la@rohde-schwarz.com

Asia/Pacific

Phone +65 65 13 04 88
customersupport.asia@rohde-schwarz.com

China

Phone +86-800-810-8228 /
+86-400-650-5896
customersupport.china@rohde-schwarz.com



Contents

1	Getting Started.....	7
1.1	Preface.....	7
1.2	Preparing for Use.....	10
1.3	Instrument Tour.....	16
1.4	Operating Basics.....	22
1.5	Maintenance.....	35
2	Waveform Setup.....	37
2.1	Connecting Probes.....	37
2.2	Vertical Setup.....	38
2.3	Horizontal Setup.....	42
2.4	Acquisition Control.....	43
2.5	Trigger.....	46
3	Waveform Analysis.....	73
3.1	Zoom.....	73
3.2	Automatic Measurements.....	75
3.3	Cursor Measurements.....	81
3.4	Mathematics.....	85
3.5	Reference Waveforms.....	87
3.6	XY-Diagram.....	91
3.7	History (Option R&S RTH-K15).....	92
4	Mask Testing.....	98
4.1	Accessing the Mask Mode.....	98
4.2	Mask Test Results.....	98
4.3	Running Mask Tests.....	99
4.4	Mask Settings.....	100
5	Spectrum Analysis.....	103
5.1	FFT Mode.....	103
5.2	Spectrum Mode (Option R&S RTH-K18).....	108
5.3	Harmonics Measurement (Option R&S RTH-K34).....	125
6	Multimeter Measurements.....	137

6.1	Digital Multimeter (R&S RTH1002).....	137
6.2	Voltmeter (R&S RTH1004).....	141
7	Data Logging.....	147
7.1	Accessing the Logger Mode.....	147
7.2	Logger Display.....	147
7.3	Logging Data.....	148
7.4	Logger Settings.....	149
7.5	Analyzing Logged Data.....	151
7.6	Logger Records.....	156
8	Protocol Analysis.....	161
8.1	Basics of Protocol Analysis.....	161
8.2	I2C (Option R&S RTH-K1).....	167
8.3	SPI (Option R&S RTH-K1).....	175
8.4	UART/RS-232/RS-422/RS-485 (Option R&S RTH-K2).....	181
8.5	CAN (Option R&S RTH-K3).....	187
8.6	LIN (Option R&S RTH-K3).....	196
9	Logic Analyzer (R&S RTH-B1 MSO).....	205
9.1	Logic Analyzer Settings.....	205
9.2	Triggering on Logic Channels.....	208
9.3	Analyzing Logic Channels.....	208
10	Frequency Counter (R&S RTH-K33).....	210
10.1	Accessing the Counter Mode.....	210
10.2	Display and Control.....	211
10.3	Performing a Counter Measurement.....	214
10.4	Counter Settings.....	216
11	Documenting Results.....	219
11.1	Using USB Flash Drive.....	219
11.2	Filesystem Tools.....	220
11.3	Instrument Settings.....	222
11.4	Waveforms.....	224
11.5	Logger Records.....	230
11.6	Quick Save with OneTouch.....	230

11.7	Screenshots.....	232
12	General Instrument Setup.....	234
12.1	Resetting the Instrument.....	234
12.2	Disabling the Touchscreen.....	234
12.3	Selfalignment.....	234
12.4	Setting the Date, Time and Language.....	236
12.5	Instrument Settings.....	237
12.6	Display Settings.....	239
12.7	Options.....	240
12.8	Updating the Firmware.....	243
13	Network Connections.....	245
13.1	LAN Connection.....	245
13.2	USB connection.....	247
13.3	Wireless LAN Connection (Option R&S RTH-K200/200US).....	247
13.4	Web Interface (Option R&S RTH-K201).....	250
14	Remote Control Commands.....	251
14.1	Conventions used in Command Description.....	251
14.2	Mode.....	251
14.3	Waveform Setup.....	252
14.4	Waveform Analysis.....	286
14.5	Mask Testing.....	300
14.6	Spectrum Analysis.....	304
14.7	Digital Multimeter (R&S RTH1002).....	330
14.8	Voltmeter (R&S RTH1004).....	346
14.9	Counter Mode (R&S RTH-K33).....	358
14.10	Data Logging.....	365
14.11	Protocol Analysis.....	374
14.12	Logic Analyzer (R&S RTH-B1 MSO).....	420
14.13	Documenting Results.....	424
14.14	General Instrument Setup.....	436
14.15	WLAN Connection (Option R&S RTH-K200/200US).....	438
	Annex.....	440

A	SCPI Command Structure.....	440
A.1	Syntax for Common Commands.....	440
A.2	Syntax for Device-Specific Commands.....	441
A.3	SCPI Parameters.....	443
A.4	Overview of Syntax Elements.....	446
A.5	Structure of a Command Line.....	447
A.6	Responses to Queries.....	448
B	Command Sequence and Synchronization.....	449
B.1	Preventing Overlapping Execution.....	449
	List of Commands.....	451

1 Getting Started

1.1 Preface

1.1.1 Key Features

The R&S RTH is the perfect multi-purpose tool for the lab and in the field. Outstanding key features are:

- Full isolation of all channels and interfaces
- CAT IV 600 V / CAT III 1000 V safety rating
- Bandwidth 60 MHz to 500 MHz with 5 GS/s sampling rate
- Acquisition speed up to 50.000 waveforms per second
- 2 mV/div sensitivity
- Up to 200 V offset range
- 33 automatic measurement functions
- Full operation using touch or keypad
- Wireless LAN and Ethernet for web based remote control and quick data access (optional)

The R&S RTH combines:

- Lab performance oscilloscope
- Logic analyzer with 8 digital inputs (optional)
- Protocol analyzer with trigger and decode (optional)
- Data logger
- Digital multimeter (R&S RTH1002)

1.1.2 Input Isolation

The instrument has independently floating isolated inputs. Each input channel has its own signal input and its own reference input. Each input channel is electrically isolated from the other input channels. Therefore, each reference of the used inputs must be connected to a reference voltage. Furthermore, input channels are electrically isolated from the communication ports and the power adapter input.

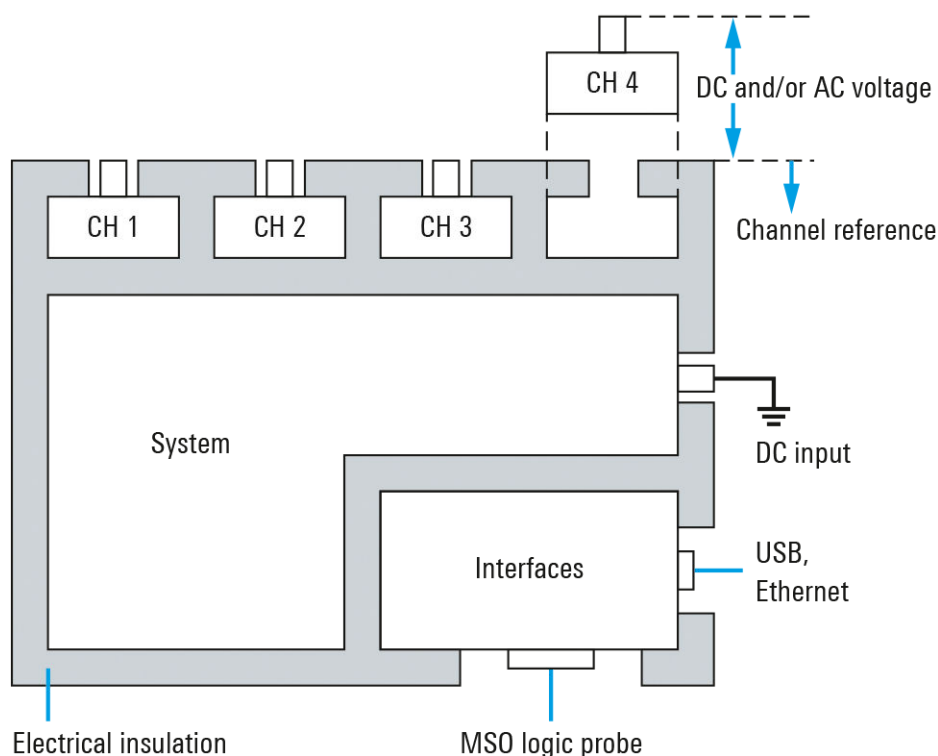

Figure 1-1: Isolation scheme of the R&S RTH

The input isolation has several advantages:

- You can measure independently floating signals simultaneously.
- The risk of causing a short circuit while measuring multiple signals is reduced substantially.
- When measuring signals with different grounds, the induced ground currents are kept to a minimum.

1.1.3 Measurement Categories

To ensure safe operation of measurement instruments, IEC 61010-2-030 defines particular safety requirements for testing and measuring circuits. The standard introduces measurement categories that rate instruments on their ability to resist short transient overvoltages that occur in addition to the working voltage of the instrument and can exceed the working voltage many times over.

Measurement categories are distinguished as follows:

- O - Instruments without rated measurement category
For measurements performed on circuits not directly connected to mains, for example, electronics, circuits powered by batteries, and specially protected secondary circuits. This measurement category is also known as CAT I.
- CAT II:

For measurements performed on circuits directly connected to the low-voltage installation by a standard socket outlet, for example, household appliances and portable tools.

- CAT III:
For measurements performed in the building installation, such as junction boxes, circuit breakers, distribution boards, and equipment with permanent connection to the fixed installation.
- CAT IV:
For measurements performed at the source of the low-voltage installation, such as electricity meters and primary overcurrent protection devices.

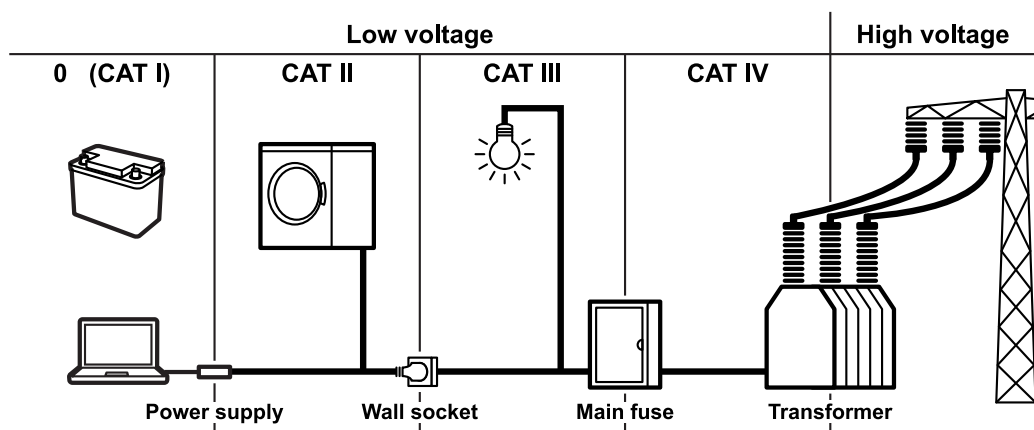

Figure 1-2: Examples of measurement categories

The higher the category, the higher the expected transient overvoltage. Overvoltages can overload a circuit and cause electrical and physical damage. Therefore, use the measurement instrument only in electrical environments for which the instrument is rated.

The measurement categories correspond to the overvoltage categories of the IEC60664 standards. Working voltages stated in context with measurement categories are always specified as effective voltages V (RMS) against earth ground.

1.1.4 Documentation Overview

The user documentation for the R&S RTH consists of the following parts:

- Instrument Help
The instrument help is part of the instrument's firmware. It offers quick, context-sensitive access to the complete information directly on the instrument.
- Basic Safety Instructions
This brochure provides safety instructions and operating conditions and further important information. The brochure is delivered with the instrument in printed form.
- Getting Started
The Getting Started manual provides the information needed to set up and start working with the instrument, and describes basic operations. The English edition of this manual is delivered with the instrument in printed form. Editions in other lan-

guages and the newest version of the English manual are available on the product website.

- **User Manual**
The user manual describes all instrument modes and functions in detail. It also provides an introduction to remote control and a complete description of the remote control commands with programming examples. The newest version of the manual is available in English on the R&S RTH product website at www.rohde-schwarz.com/manual/rth.
- **Data Sheet**
The data sheet contains the complete instrument specification. It also lists the options and their order numbers, and optional accessories. The data sheet is available on the R&S RTH product website at www.rohde-schwarz.com/brochure-data-sheet/rth.
- **Calibration Certificate**
The document is available on <https://gloris.rohde-schwarz.com/calcert>.
- **Open Source Acknowledgment**
The Open Source Acknowledgment document provides verbatim license text of open source software that is used in the instrument's firmware. It is available on the R&S RTH website at www.rohde-schwarz.com/firmware/rth, and it can be read directly on the instrument.
- **Instrument security procedures manual**
Provides information on security issues when working with the R&S RTH in secure areas.
- **Application cards and application notes**
These documents deal with special applications or background information on particular topics. See www.rohde-schwarz.com/application/rth

1.2 Preparing for Use

This section describes the basic steps to be taken when setting up the R&S RTH for the first time.

⚠ WARNING**Shock hazard caused by high voltages**

The instrument must be used in an appropriate manner to prevent electric shock, fire, personal injury, or damage.

- Do not open the instrument casing.
- Do not use the instrument if the instrument casing, the display or any probe or accessory are damaged. If you detect or suspect any damage, have the instrument or accessory inspected by qualified service personnel.
- Use only specified probes and accessories that comply with the measurement category of your measurement task.
If you use other than Rohde & Schwarz accessories, make sure that they are suitable to the instrument and the measurement task.
- Do not operate the instrument in wet, damp or explosive atmospheres.
Make sure that all connectors are completely dry before connecting the inputs.
- Voltages higher than 30 V RMS or 42 V peak or 60 V DC are regarded as hazardous contact voltages. Make sure that only electrically skilled persons may use the R&S RTH for measurements on hazardous contact voltages because these working conditions require special education and experience to perceive risks and to avoid hazards which electricity can create.
- Observe the operating conditions specified in the data sheet. Note that the general safety instructions also contain information on operating conditions that will prevent damage to the instrument.
- Read and observe the "Basic Safety Instructions" delivered as a printed brochure with the instrument. In addition, read and observe the safety instructions in the following sections.

1.2.1 Unpacking the Instrument

When you receive your shipping package, unpack and inspect the package and its contents for damage.

1. Inspect the package for damage.
If the packaging material shows any signs of stress, notify the carrier as well as your Rohde & Schwarz service center. Keep the package and cushioning material for inspection. Keep a damaged package and the cushioning material until the contents have been checked for completeness and the instrument has been tested.
2. Unpack the handheld scope and the accessories and check the contents for completeness, see "[Package contents](#)" on page 12.
If anything is missing, contact your Rohde & Schwarz service center.
3. Inspect the handheld scope and the accessories.
If there is any damage or defect, or if the R&S RTH does not operate properly, notify your Rohde & Schwarz service center.

**Packing material**

Retain the original packing material. If the instrument needs to be transported or shipped at a later date, you can use the material to protect the control elements and connectors.

Package contents

The delivery package contains the following items:

- R&S RTH handheld scope
- 4 Gbyte microSD card, installed in the battery compartment
- Power adapter with cable and adapter set for various socket types
- Battery pack
- R&S RT-ZI10 probes (2x for R&S RTH1002; 4x for R&S RTH1004)
- DMM test leads (only for R&S RTH1002)
- Hand strap, attached on the handheld scope
- Printed "Getting Started" manual and "Basic Safety Instructions" brochure

Optional accessories and their order numbers are listed in the data sheet.

1.2.2 Inserting and Charging the Battery

Before you can use the handheld scope for the first time, insert the battery pack and charge it.

⚠ WARNING**Risk of electrical shock during battery replacement**

- Disconnect power supply, probes, test leads and all other cables before opening the battery cover.
- Use only the specified Li-Ion battery pack, which is delivered with the instrument. You can order additional battery packs at Rohde & Schwarz, see Data Sheet for order number.
- Do not operate the instrument with the battery cover open.
- Use only the specified power adapter, which is delivered with the instrument.

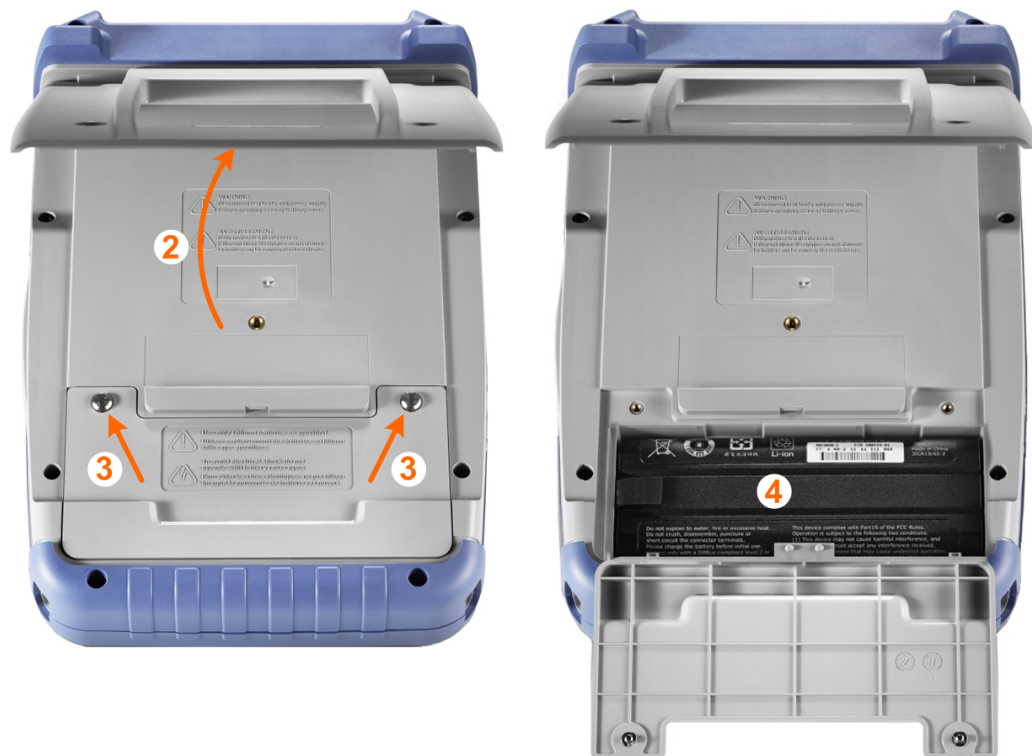

1. Turn off the instrument power. Remove power supply, probes, test leads and all other cables.
2. Fold out the tilt stand on the back of the instrument.
3. Screw open the battery cover.
4. Insert the battery pack.
5. Screw down the battery cover.
6. Connect the power adapter to the connector on the left side of the scope, and fully charge the battery. Charging may take a few hours.



If the instrument is on, the battery status is shown on the display.



Replace used batteries periodically by new batteries after 24 months of usage. Observe the safety regulations in the "Batteries and rechargeable batteries/cells" chapter in the "Basis Safety Instructions" brochure, which is delivered with the instrument.

1.2.3 Powering On/Off

- ▶ Press the  POWER key to switch the instrument on or off. The key blinks and turns green after a few seconds.

Table 1-1: Colors of the Power key

Green	Power is on
Blue	Charging the battery, power is off
Orange (yellow)	Battery is fully charged, power adapter is connected, power is off

If you do not use the instrument for a longer time, the battery gets exhausted. When you connect the power supply and switch on the instrument with exhausted battery, it takes a few minutes until the instrument can start.

1.2.4 Using the Tilt Stand

The R&S RTH has a tilt stand for proper handling while the scope is placed on a table.

- ▶ Pull the tilt stand as shown below.



1.2.5 EMI Suppression

Electromagnetic Interference (EMI) may affect the measurement results.

To suppress generated Electromagnetic Interference:

- Use suitable shielded cables of high quality. For example use double-shielded RF and LAN cables.
- Always terminate open cable ends.
- Note the EMC classification in the data sheet.

1.3 Instrument Tour

1.3.1 Front View

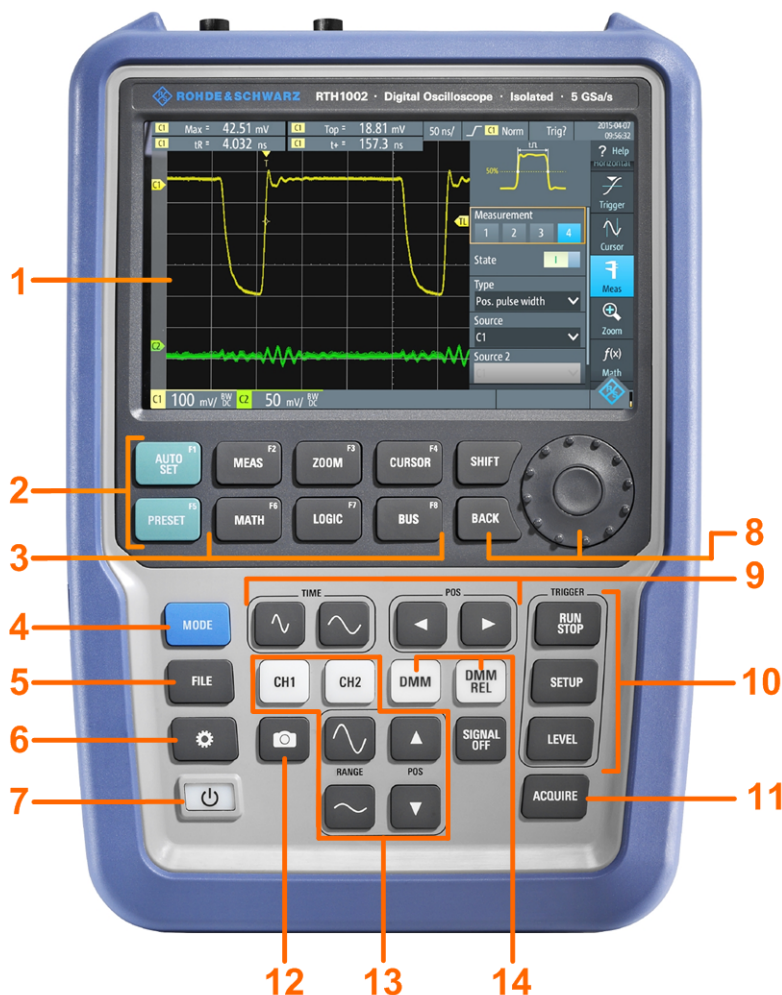

Figure 1-3: Front panel of the R&S RTH1002

- 1 = Touch display
- 2 = Waveform setup with AUTOSET, reset to default with PRESET
- 3 = Analysis functions
- 4 = Mode selection
- 5 = Save/Recall
- 6 = Instrument settings
- 7 = Power on/off
- 8 = Navigation controls
- 9 = Horizontal settings
- 10 = Run/stop acquisition and trigger settings
- 11 = Acquisition settings
- 12 = Screenshot and documentation output
- 13 = Channels and vertical settings
- 14 = Multimeter measurements

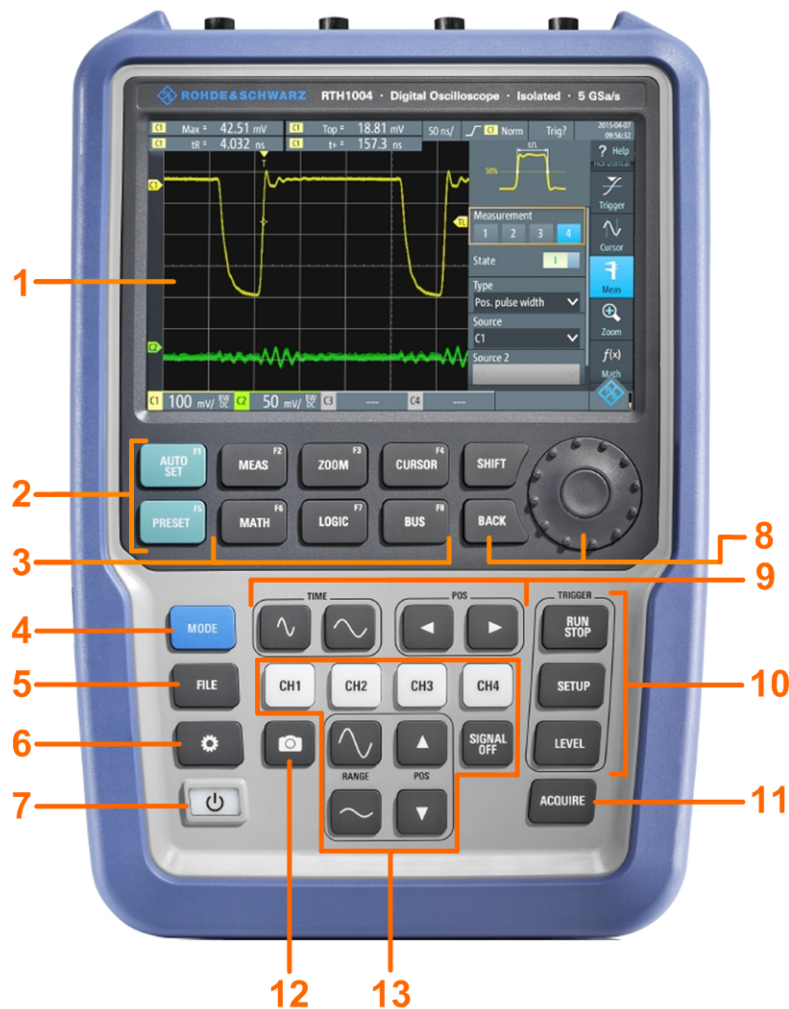

Figure 1-4: Front panel of the R&S RTH1004

- 1 = Touch display
- 2 = Waveform setup with AUTOSET, reset to default with PRESET
- 3 = Analysis functions
- 4 = Mode selection
- 5 = Save/Recall
- 6 = Instrument settings
- 7 = Power on/off
- 8 = Navigation controls
- 9 = Horizontal settings
- 10 = Run/stop acquisition and trigger settings
- 11 = Acquisition settings
- 12 = Screenshot and documentation output
- 13 = Channels and vertical settings

For a description of the keys, see [Chapter 1.4.1.3, "Using Front Panel Keys"](#), on page 29.

1.3.2 Top View

The R&S RTH1002 has two BNC input connectors CH1 and CH2, and two 4 mm banana plug inputs for multimeter measurements. The channel inputs have double channel-to-channel isolation that allows for independent floating measurements at each input. The DMM input is fully isolated from scope inputs, interfaces, and ground.



Figure 1-5: Top view of R&S RTH1002

The R&S RTH1004 has four BNC input connectors CH1, CH2, CH3, CH4. The channel inputs have double channel-to-channel isolation that allows for independent floating measurements at each input.



Figure 1-6: Top view of R&S RTH1004

⚠ WARNING

Shock hazard caused by high voltages

To avoid electrical shock and personal injury, and to prevent damage to the instrument or any other products connected to it, observe the following:

- Do not apply input voltages above the rating of the instrument and the accessories.
- Use only probes, test leads, and adapters that comply with the measurement category (CAT) of your measurement task.
- Test leads and measurement accessories used for multimeter measurements on a live mains circuit must be rated for CAT III or CAT IV according to IEC 61010-031. The voltage of the measured circuit must not exceed the rated voltage value.

Maximum input voltage:

- At BNC inputs: CAT IV 300 V
- With probe R&S RT-ZI10 or R&S RT-ZI11: CAT IV 600 V, CAT III 1000 V
- Meter input: CAT IV 600 V; CAT III 1000 V

Voltage ratings: V RMS (50 to 60 Hz) for AC sine wave and V DC for DC applications.

⚠ WARNING**Risk of electrical shock or fire**

Voltages higher than 30 V RMS or 42 V peak or 60 V DC are regarded as hazardous contact voltages. When working with hazardous contact voltages, use appropriate protective measures to preclude direct contact with the measurement setup:

- Use only insulated voltage probes, test leads and adapters.
- Do not touch voltages higher than 30 V RMS or 42 V peak or 60 V DC.

See also: [Chapter 1.1.2, "Input Isolation"](#), on page 7.

1.3.3 Right View

- 1 = LAN
- 2 = USB type B for remote control
- 3 = Probe compensation
- 4 = USB type A for flash drive
- 5 = Logic probe connector

⚠ CAUTION**Risk of injury or instrument damage**

Always close the lids of the communication ports and DC input when they are not in use.

LAN connector

RJ-45 connector to connect the instrument to a Local Area Network (LAN). It supports up to 100 Mbit/s.

USB type A connector

USB type A connector to connect a USB flash drive to store and reload instrument settings and measurement data.

USB type B connector (mini USB)

Mini USB connector to connect a computer for remote control of the instrument.

Probe compensation

Probe compensation terminal to support adjustment of passive probes to the oscilloscope channel.

Logic probe connector

Input for the logic probe R&S RT-ZL04. Logic analysis requires Mixed Signal Option R&S RTH-B1, which includes the logic probe R&S RT-ZL04.

⚠ WARNING**Risk of electrical shock - no CAT rating for MSO measurements**

The logic probe R&S RT-ZL04 is not rated for any measurement category. To avoid electrical shock or personal injury, and to prevent material damage, make sure that the ground clips of the R&S RT-ZL04 are connected to protective earth on the DUT.

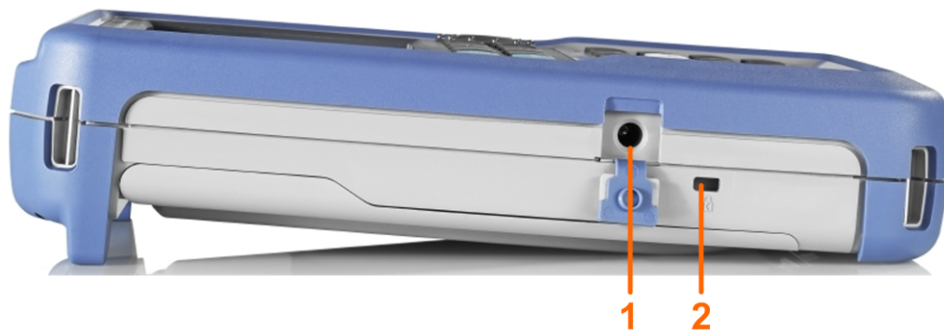
1.3.4 Left View

- 1 = DC input
- 2 = Kensington lock slot

DC input

Connector for the power adapter to charge the battery.

Kensington lock slot

The Kensington lock is used to secure the instrument against theft.

1.3.5 Rear View



- 1 = Tilt stand to fold out
- 2 = Thread hole M5
- 3 = Battery compartment

1.3.6 Display Overview

In the most important modes scope, mask and XY, the display shows the following information.

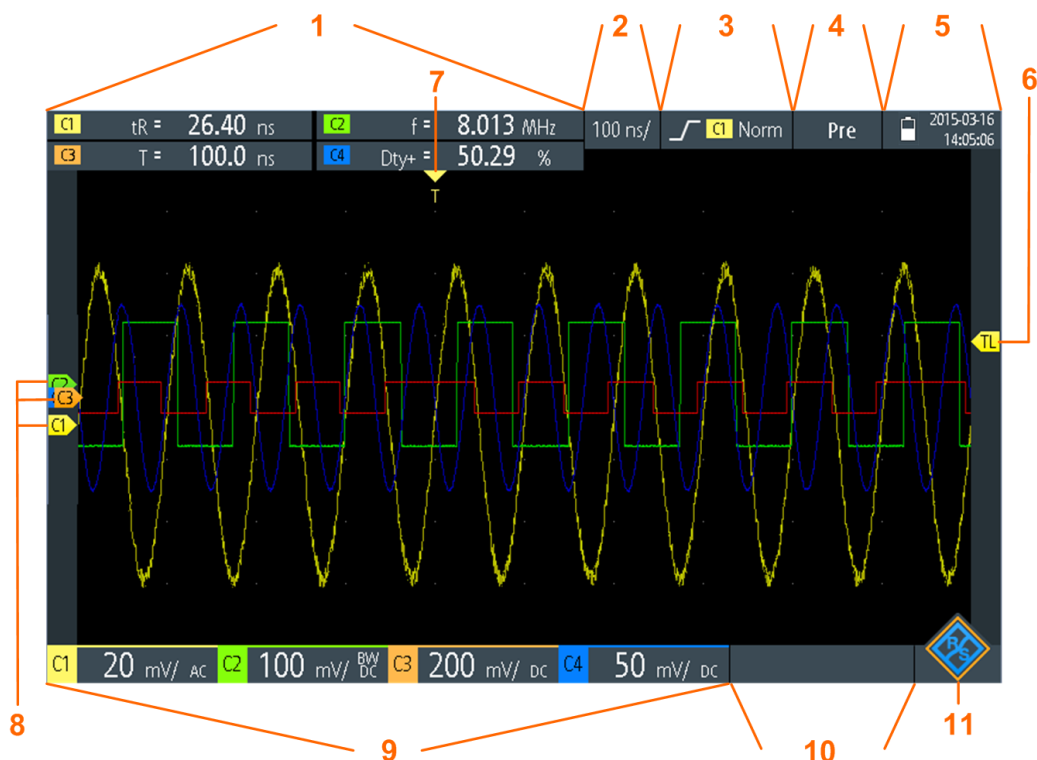

- 1 = Measurement results, depends on the mode and the selected measurement
- 2 = Time scale (horizontal scale, in s/division)
- 3 = Trigger type, trigger source, and trigger mode
- 4 = Capture status
- 5 = Battery status and AC connectivity for battery charging; date and time
- 6 = Trigger level marker, has the color of the trigger source
- 7 = Trigger position marker, has the color of the trigger source
- 8 = Channel markers indicate the ground levels. Channel C3 has the focus
- 9 = Vertical settings for each active channel: vertical scale (vertical sensitivity, in V/division), bandwidth limit (no indicator = full bandwidth, BW= limited frequency), coupling (AC or DC)
- 10 = Logic channels (MSO R&S RTH-B1)
- 11 = Menu button

You can adjust the vertical position of each waveform, the trigger level, and the trigger position by dragging the corresponding marker on the display. Alternatively, tap a marker to set the focus, and use the wheel to adjust position.

1.4 Operating Basics

1.4.1 Accessing the Functionality

The complete functionality is available in the menus and dialogs on the touchscreen. You can touch the functions directly on the display, or you can use the wheel to navigate and select. In addition, the most important functions are applied to the keys on the front panel to set up and perform measurement tasks quickly.

1.4.1.1 Using the Touchscreen

Using the touchscreen of the R&S RTH is as easy as using your mobile phone. To open the menu, tap the "Menu" button - that is the R&S logo in the right bottom corner of the display.

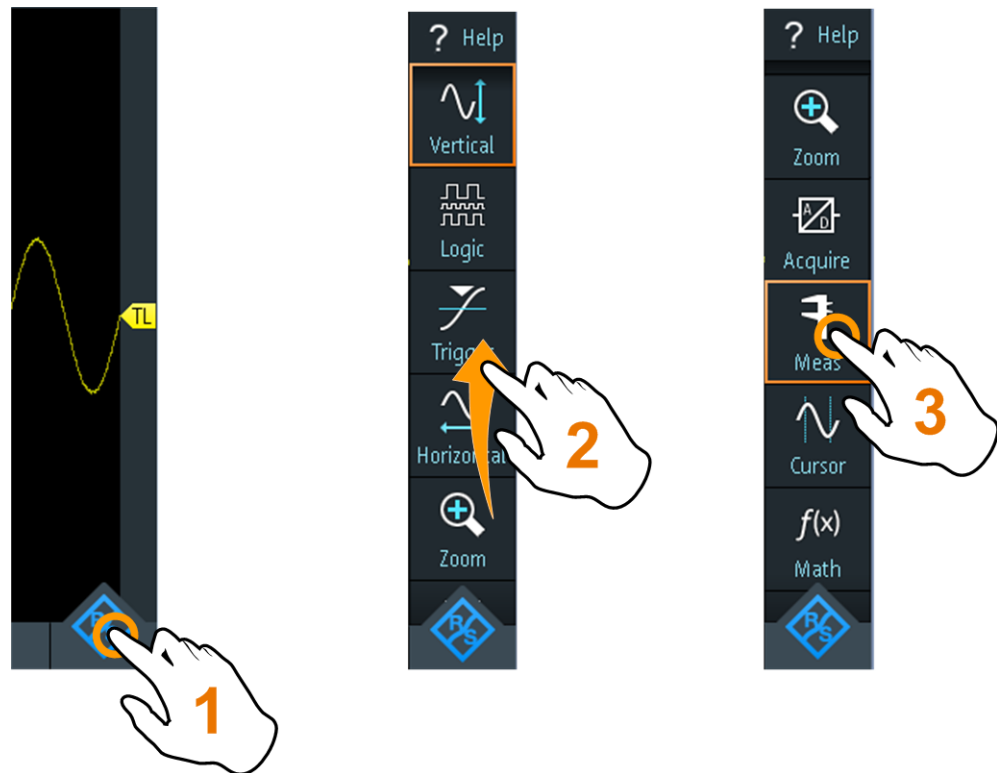

Figure 1-7: Open the menu and select a menu item



Figure 1-8: Switch on or off (left) and select a parameter value (right)

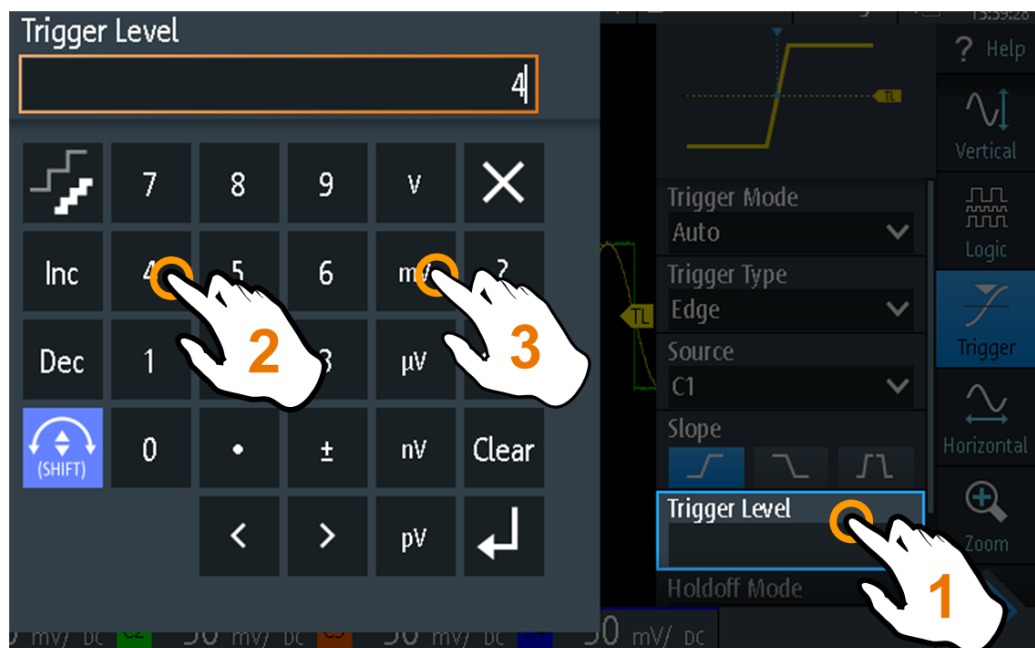

Figure 1-9: Enter numerical value and unit

1.4.1.2 Using the Navigation Wheel

In addition or alternatively to the touchscreen, you can use the wheel to control the R&S RTH.

When using the wheel, always observe the position of the focus - the orange frame or other highlighting that marks the active object on the screen.

- If the focus is on the menu button or somewhere in the menu or dialogs:
 - Turn the wheel to move the focus.
 - Press the wheel button to apply the selection.
- If the focus is on an element in the diagram, for example, on a waveform, cursor line, or trigger level:
 - Turn the wheel to change the position of the active element.
 - Press the wheel button to toggle the active element, for example, to toggle the cursor lines, or zoom size and zoom position.

The BACK key closes open dialogs and menus, and resets the focus to the "Menu" button.

Menu navigation

The following procedure describes how to access and navigate the menu. Navigating dialogs and selecting parameter values works in the same way. See also [Figure 1-10](#).

1. Press BACK until the focus is on the "Menu" button.
2. Press the wheel button to open the menu.
3. Turn the wheel to move the focus to the required menu item.
4. Press the wheel button to open the dialog, submenu, or keypad for the selected menu item.

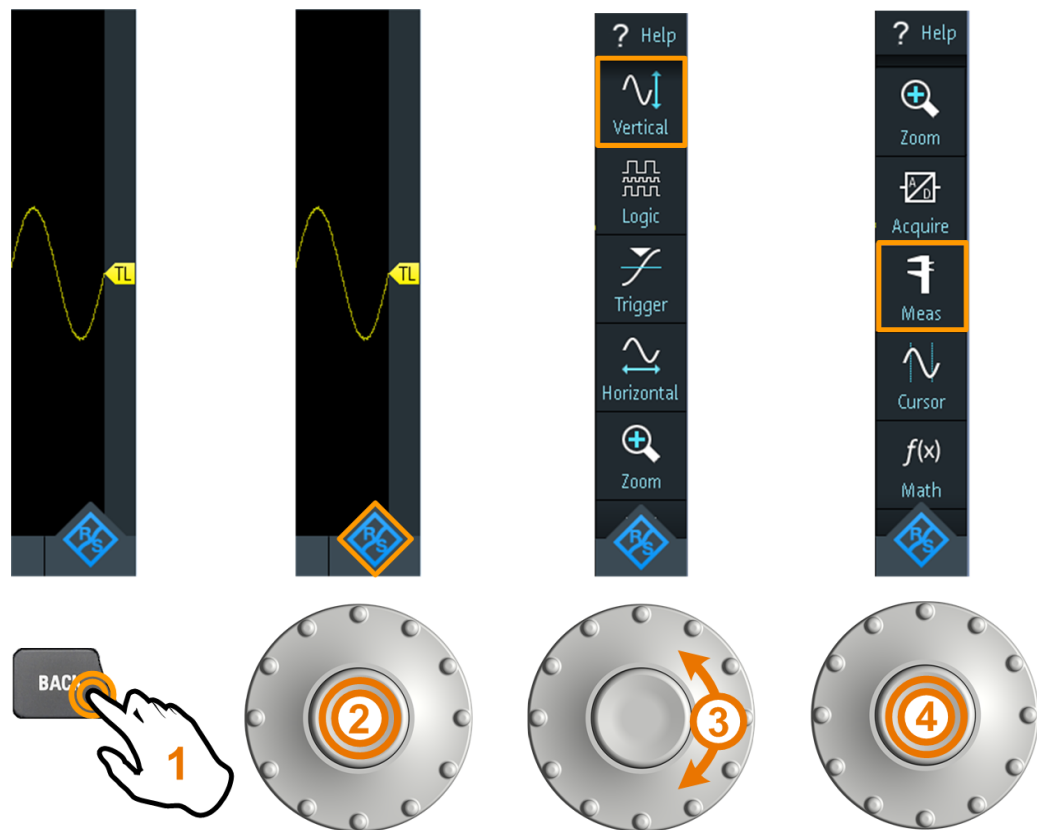

Figure 1-10: Open the menu and select a menu item

Set numerical value using the wheel

1. Set the focus to the required setting, and press the wheel button *once*.
2. Turn the wheel until the required value is shown.
3. Press BACK.



Figure 1-11: Set numerical value using the wheel

Data entry using wheel and keypad

You can enter precise numerical values on the keypad. See also [Figure 1-12](#).

1. Set the focus to the required setting, and press the wheel button *twice*.
2. Turn the wheel until the focus is on the required number.
3. Press the wheel button.
4. Turn the wheel until the focus is on the required unit.
5. Press the wheel button.

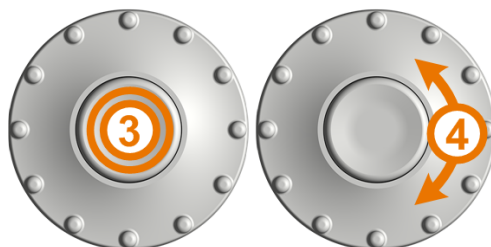
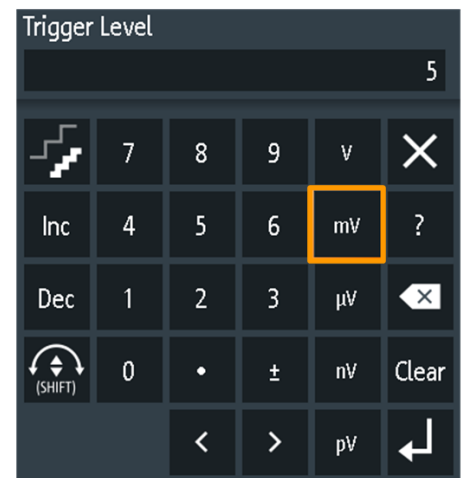
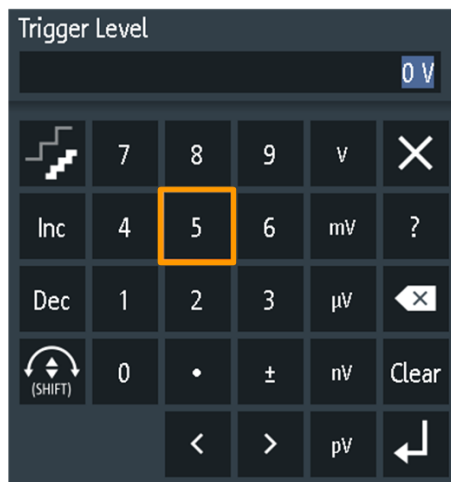
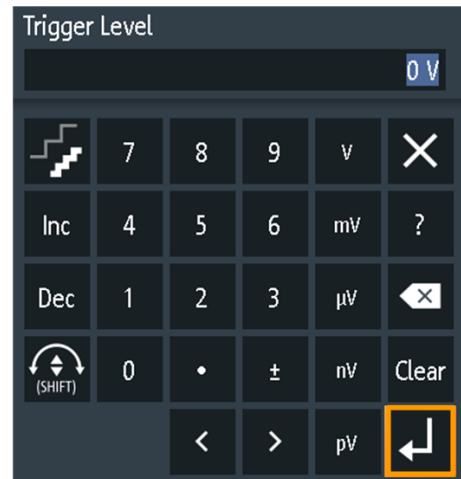





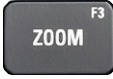

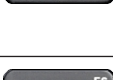
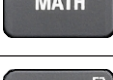



Figure 1-12: Enter numerical value and unit in the keypad











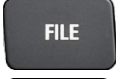



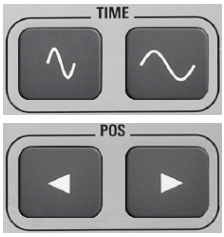

The SHIFT button toggles the wheel focus in the keypad. If the focus is on the entry field, turning the wheel changes the value. If the focus is in the lower part, the wheel selects numbers and unit.

1.4.1.3 Using Front Panel Keys

For an overview of the front panel keys, see [Figure 1-4](#)

Key	Press shortly	Press and hold
	AUTOSET analyses the active channels, adjusts the instrument settings, and displays stable waveforms.	
	PRESET sets the instrument to the default factory state.	
	MEAS starts or stops the last configured automatic measurements.	Opens or closes the "Meas" dialog to configure the measurements.
	ZOOM enables or disables the zoom with the last configuration. If the zoom is on but not in focus, pressing the key focuses the zoom.	Opens or closes the "Zoom" dialog to configure the zoom scale and position.
	CURSOR starts or stops the last configured cursor measurement. If the cursor is on but not in focus, pressing the key sets the focus to the first cursor line.	Opens or closes the "Cursor" dialog to configure the measurement.
	MATH switches the math waveform on or off.	Opens or closes the "Math" dialog to configure the math waveform.
	Requires logic analyzer option R&S RTH-B1 (MSO). The effect depends on the state of digital channels: If the all digital channels are off, the key switches them on and sets the focus. If the digital channels are on but not in focus, the key sets the focus. If the focus is on digital channels, the key switches them off.	Opens or closes the "Logic" dialog to configure digital channels.
	Activates or deactivates the serial bus. Requires at least one serial triggering and decoding option. Available options are listed in the data sheet.	Opens or closes the "Bus" dialog to configure serial protocols.
	SHIFT opens a dialog to save and load instrument settings.	Press and hold for 2 seconds to disable or enable the touch-screen.
	If a dialog or menu is open, BACK closes it. If the menu is closed, the key toggles the focus between focused element in the diagram and the Menu button.	

Key	Press shortly	Press and hold
  	Open or close the "Mode", "File" or "Setup" dialog, respectively.	
	Saves measurement documentation: Only screenshot if "one touch" is off. ZIP file with selected data if "one touch" is on.	Opens or closes the "Screenshot" dialog to configure the screenshot and the "one touch" output.
All R&S RTH:  Only R&S RTH1004: 	The effect depends on the channel state: If the channel is off, the key switches on the channel and sets the focus. The key lights up. If the channel is on but not in focus, the key sets the focus. The key lights up.	Open or close the "Vertical" dialog for the corresponding channel to configure the channel settings.
Only R&S RTH1002: 	DMM starts or stops the meter measurements (same as MODE = "Meter"). DMM REL enables or disables relative meter measurements.	Opens or closes the "Meter" dialog to configure the measurements.
	TIME and POS adjust the horizontal time scale and position of the trigger point.	
	RANGE and POS set the vertical scale (vertical sensitivity) and the vertical position of the focused waveform (analog or channel, math or reference waveform).	
	SIGNAL OFF switches off the focused waveform.	
	RUN STOP starts and stops the acquisition.	
	SETUP opens or closes the "Trigger" dialog to select the trigger type and adjust the trigger settings.	

Key	Press shortly	Press and hold
	LEVEL activates the trigger level to be set using the wheel. If the trigger type has two trigger levels, pressing the key toggles the upper and lower levels.	
	ACQUIRE opens or closes the "Acquire" dialog to adjust the acquisition mode.	
	POWER key: switches the power on or off	

1.4.2 Selecting the Mode

A mode comprises all settings and functions that are needed to perform a measurement task. Selecting the mode is the first setup step.

1. Press the MODE key.

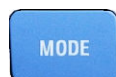

2. Select the mode:

- On the touchscreen: Tap the required mode icon.
- Using controls: Turn the wheel until the required mode is marked, and press the wheel button to select the mode.

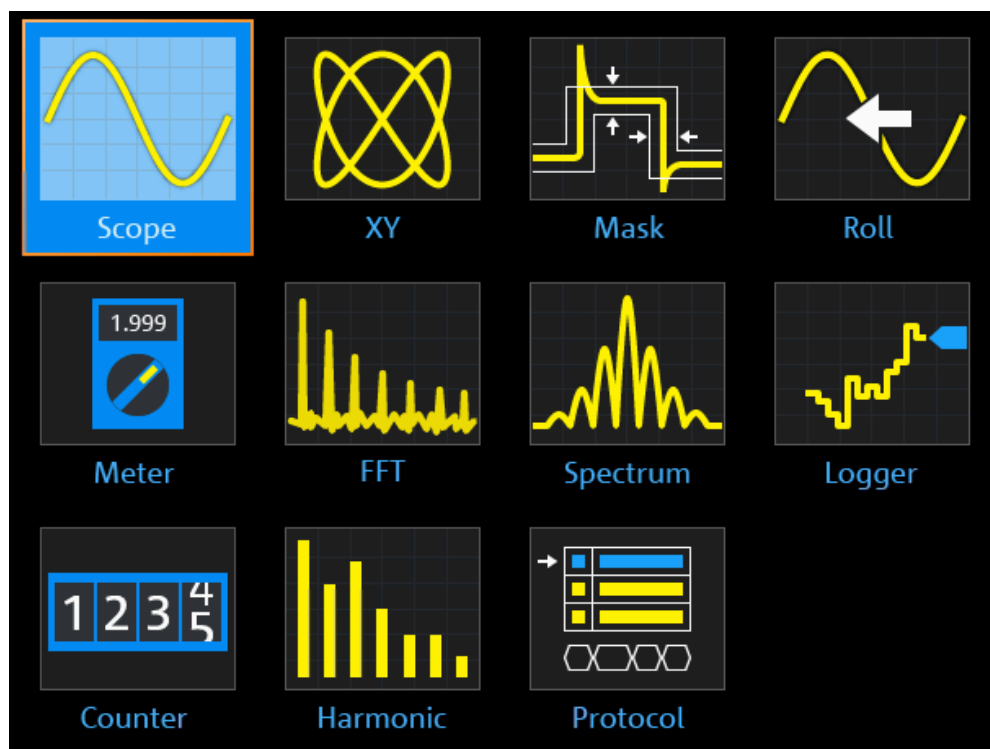

Remote command:

[OP \[:MODE\]](#) on page 251

1.4.3 Displaying an Unknown Signal

The R&S RTH can display unknown, complex signals automatically. The AUTOSET function analyzes the enabled channel signals, and adjusts the horizontal, vertical, and trigger settings to display stable waveforms.

1. Press the PRESET key.



PRESET sets the instrument to a default factory state. The previous user-defined configuration is removed and all channels except for channel 1 are disabled.

2. Press the AUTOSET key.



The waveform is displayed.

1.4.4 Getting Information and Help

In most dialogs, graphics explain the meaning of the selected setting. For further information, you can open the help, which provides functional description of the settings with links to the corresponding remote commands, and background information.

1.4.4.1 Displaying Help

- ["To open the help window"](#) on page 32
- ["To show information on a setting"](#) on page 33
- ["To close the help window"](#) on page 33

To open the help window

- ▶ Tap the "Help" icon on the top of the menu.



If a dialog is open, the dialog's help topic is shown beside the dialog.

If a menu is open, the table of contents is shown.

To show information on a setting

If a dialog and the help window are open, you can easily call the information on each setting of the dialog.

- ▶ Tap the setting's *name*.

The corresponding help topic is displayed.

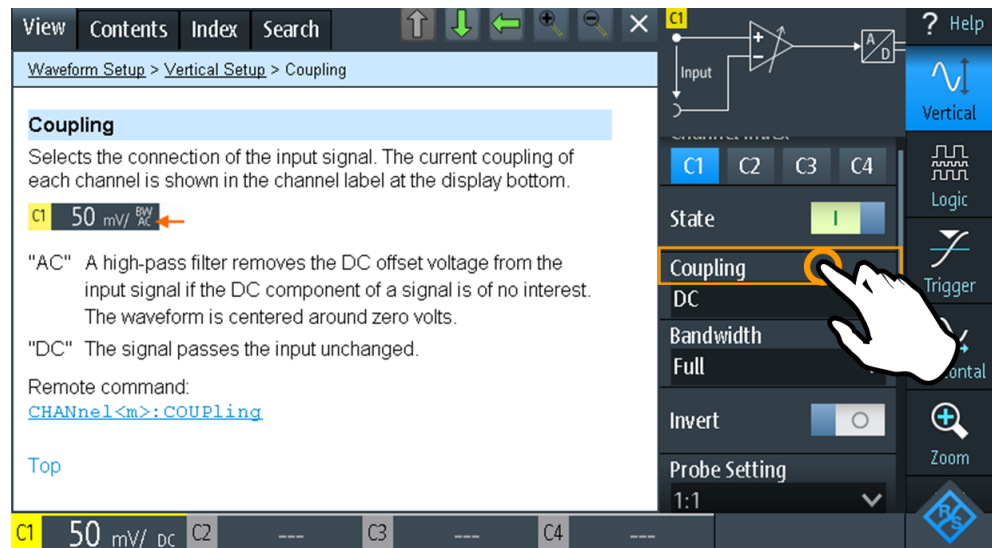

If you tap the *switch* or the *entry field*, you can adjust the setting without closing the help window.

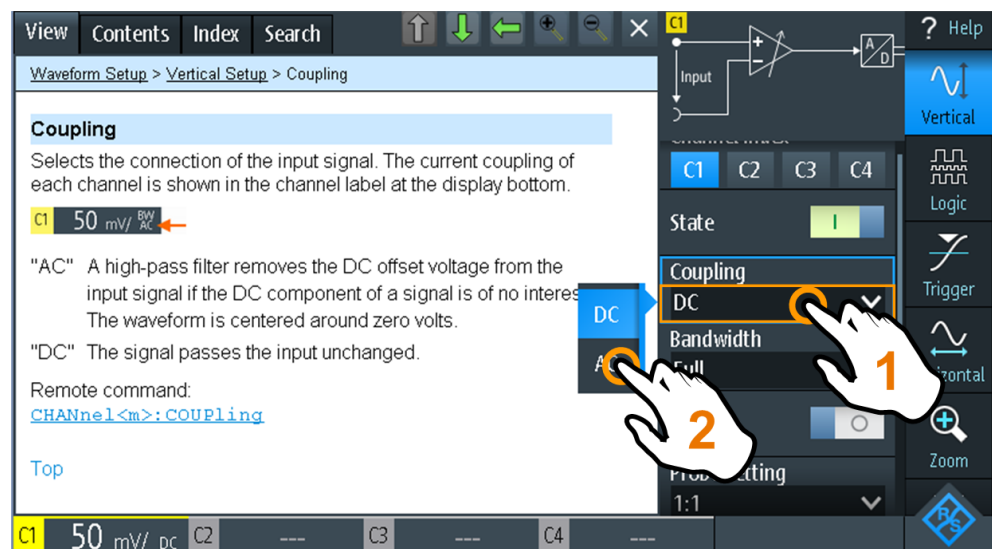

To close the help window

- ▶ Tap the "Close" icon in the upper right corner of the help window, or press BACK.

1.4.4.2 Using the Help Window

The help window has several tabs:



- "View": shows the selected help topic.
- "Contents": contains a table of help contents.
- "Index": contains index entries to search for help topics.
- "Search": provides text search.

The help toolbar provides the following buttons:



- Up and down arrows: browse the topics in the order of the table of contents. Up = previous topic, down = next topic.
- Left and right arrows: browse the topics visited before: Left = back, right = forward.
- Magnifiers: increase or decrease the font.
- ×: closes the help window.

To search for a topic in the index

The index is sorted alphabetically. You can browse the list, or search for entries.

1. Tap the "Index" tab.
2. Tap the entry field on top of the list.
3. Enter some characters of the keyword you are interested in.
You can use the Backspace key to delete single characters, and "Clear" to delete all characters in the "Keyword" field.
4. Tap the Enter key.
Now only index entries are displayed that contain the keyword characters.
5. To delete the keyword:
 - a) Tap the entry field again.
 - b) Tap "Clear".
 - c) Tap the Enter key.

To search the help for a text string

1. Tap the "Search" tab.
2. Tap the entry field on the top.
3. Enter the words you want to find.
If you enter several words with blanks between, topics containing all words are found.

To find a string of several words, enclose it in quotation marks. For example, a search for *"trigger mode"* finds all topics with exactly *"trigger mode"*. A search for *trigger mode* finds all topics that contain the words *trigger* and *mode*.

4. Tap the Enter key.
A list of search results is displayed.
5. To refine the search, use "Match Whole Word" and "Match Case", and tap "Start Search".

1.5 Maintenance

The instrument does not need a periodic maintenance. Only cleaning the instrument is essential.

The addresses of the Rohde & Schwarz support centers can be found at www.customersupport.rohde-schwarz.com.

A list of service centers is available on www.services.rohde-schwarz.com.

1.5.1 Cleaning

WARNING

Shock hazard

Before cleaning the instrument, remove all probes, leads, USB and LAN cables and power supply.

NOTICE

Instrument damage caused by cleaning agents

Cleaning agents contain substances that may damage the instrument. For example, cleaning agents that contain a solvent may damage the front panel labeling, plastic parts, or the display.

Never use cleaning agents such as solvents (thinners, acetone, etc), acids, bases, or other substances.

The outside of the instrument can be cleaned sufficiently using a soft, lint-free dust cloth.

1.5.2 Data Storage and Security

The instrument is delivered with the 4 Gbyte microSD card inserted and ready to use. We recommend that you do not remove the microSD card.

All instrument configuration data and user data are stored on the microSD card. In addition, a fallback firmware is stored on the microSD card to boot the instrument if an update failed.

If you use the instrument in a secured environment, you can remove the microSD card before the instrument leaves this area. The microSD card slot is under the right lid under the battery pack.

You can also change the microSD card if you need more memory. The instrument supports microSD cards up to 32 Gbyte.

1.5.3 Storing and Packing

The storage temperature range of the instrument is given in the data sheet. If the instrument is to be stored for a longer period of time, it must be protected against dust.

Repack the instrument as it was originally packed when transporting or shipping. The two protective foam plastic parts prevent the control elements and connectors from being damaged. The antistatic packing foil avoids any undesired electrostatic charging to occur.

If you do not use the original packaging, use a sturdy cardboard box of suitable size and provide for sufficient padding to prevent the instrument from slipping inside the package. Wrap antistatic packing foil around the instrument to protect it from electrostatic charging.

2 Waveform Setup

2.1 Connecting Probes

WARNING

Shock hazard caused by high voltages

Make sure to set the attenuation factor on the instrument according to the probe being used. Otherwise, the measurement results do not reflect the actual voltage level, and you might misjudge the actual risk.

1. Connect the probe(s) first to the channel input(s) at the top of the instrument, and then to the DUT.
2. Press and hold the CH key of the used input.
3. Select "Probe Setting".
4. Select the attenuation factor of the probe.
The probe's attenuation factor is indicated on the probe.

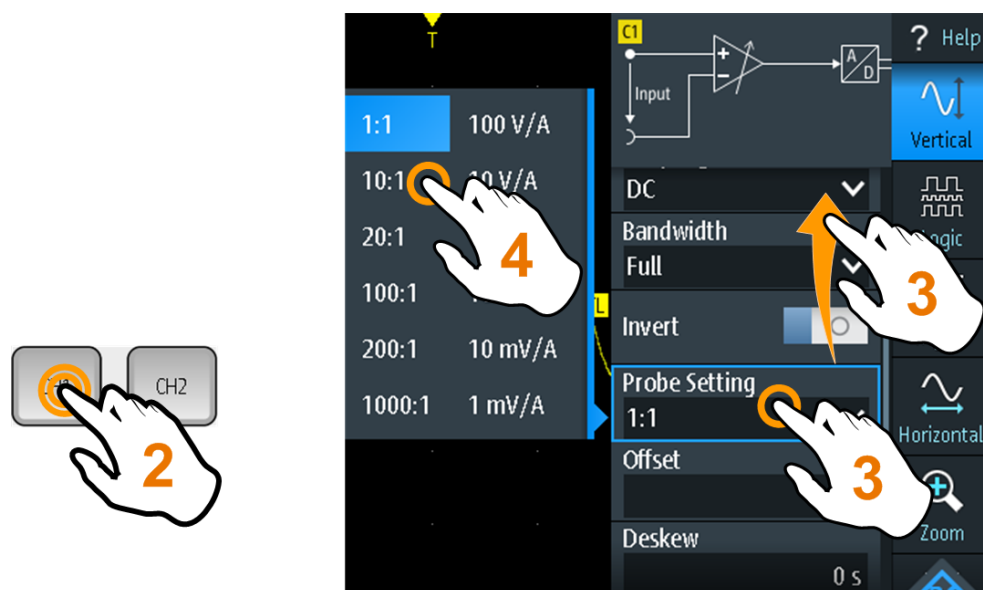

Note: If you perform current measurements using a shunt resistor as a current sensor, you have to multiply the V/A-value of the resistor by the attenuation of the probe. For example, if a $1\ \Omega$ resistor and a 10:1 probe is used, the V/A-value of the resistor is 1 V/A, the attenuation factor of the probe is 0.1, and the resulting current probe attenuation is 100 mV/A.

2.2 Vertical Setup

The controls and parameters of the vertical system adjust the scale and position of the waveform vertically.



1. To set vertical scale and position, use the RANGE and POS keys.



2. To adjust other vertical settings, select "Vertical" in the main menu.

Vertical scale and vertical position affect the resolution of the waveform amplitude directly. To get the full resolution, make sure that the waveforms cover most of the screen's height.

2.2.1 Vertical Settings

As long as the "Vertical" menu is open, the probe settings of active channels are shown on top of the display.

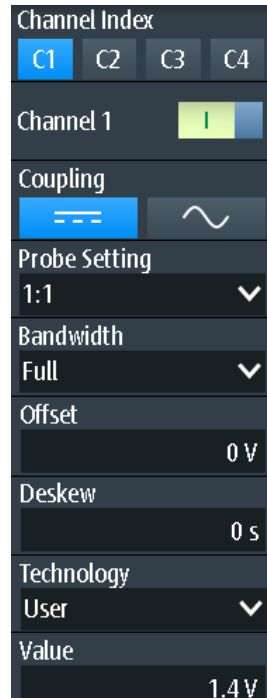

Channel Index

Selects the channel to be configured. All settings in the channel menu belong to the selected channel.

You can also shortly press the channel key to select a channel. If you press and hold the channel key, the corresponding channel menu opens.

Channel <n>

Switches the selected channel on or off.

Remote command:

[CHANnel<m>:STATe](#) on page 252

Coupling

Selects the connection of the input signal. The current coupling of each channel is shown in the channel label at the display bottom.



AC coupling. A high-pass filter removes the DC offset voltage from the input signal if the DC component of a signal is of no interest. The waveform is centered on zero volts.



DC coupling, the signal passes the input unchanged.

Remote command:

[CHANnel<m>:COUPling](#) on page 254

Probe Setting

Selects the attenuation factor of the connected probe. The vertical scaling and measured values are multiplied by this factor so that the displayed values are equal to the actual signal values.

Make sure to set the attenuation factor on the instrument according to the probe being used. Otherwise, the measurement results do not reflect the actual voltage level, and you might misjudge the actual risk.

Bandwidth

Selects the bandwidth limit. The full instrument bandwidth indicates the range of frequencies that the instrument can acquire and display accurately with less than 3 dB attenuation.

For analog applications, the highest signal frequency determines the required oscilloscope bandwidth. The oscilloscope bandwidth should be at least 3 times higher than the maximum frequency included in the analog test signal to measure the amplitude with high accuracy.

Most test signals are more complex than a simple sine wave and include several spectral components. A digital signal, for example, is built up of several odd harmonics. For digital signals, the oscilloscope bandwidth should be at least 5 times higher than the clock frequency to be measured.

The oscilloscope is not an autonomous system. You need a probe to measure the signal, and the probe has a limited bandwidth, too. The combination of oscilloscope and probe creates a system bandwidth. To reduce the effect of the probe on the system bandwidth, the probe bandwidth should exceed the bandwidth of the oscilloscope, the recommended factor is 1.5 x oscilloscope bandwidth.

See also: [Chapter 2.2.2, "Effect of the Bandwidth Filter"](#), on page 41.

For FFT analysis, the channel bandwidth also determines the frequency range displayed in the spectrum (see "Frequency range" on page 104).

- "Full" At full bandwidth, all frequencies in the specified range are acquired and displayed. Full bandwidth is used for most applications.
- "x MHz, x kHz" Frequency limit. Frequencies above the selected limit are removed to reduce noise at different levels. Limited bandwidth is indicated in the channel label.



Remote command:

[CHANnel<m>:BANDwidth](#) on page 254

Offset

Sets an offset voltage that is added to correct an offset-affected signal. The value is included in measurement results. The signal is shifted in relation to the ground level by the offset value. Negative offset values move the waveform down, positive values move it up.

Remote command:

[CHANnel<m>:OFFSet](#) on page 254

Deskew

Sets a delay for the selected channel.

Deskew compensates delay differences between channels caused by the different length of cables, probes, and other sources. Correct deskew values are important for accurate triggering. The propagation delay may lead to a non-synchronous waveform display. For example, a coax cable with a length of 1 meter has a propagation delay of typically 5.3 ns.

Remote command:

[CHANnel<m>:DESKew](#) on page 255

Technology, Value

Sets the threshold, which is used to obtain the signal state. If the signal value is higher than the threshold, the signal state is high (1 or true for the Boolean logic). Otherwise, if the signal value is below the threshold, the signal state is considered low (0 or false). The threshold is used by the pattern and state trigger.

If a protocol option is installed, and the channel is used in the bus, the configured channel threshold is also used in the bus configuration. The values are the same in "Vertical" menu and bus configuration dialogs.

- "Technology" Select a predefined value for one of the most common technologies, or select "User" to define an individual threshold.

- "Value" Set an individual threshold value if "Technology" is set to "User".

Remote command:

[CHANnel<m>:THReshold:TECHnology](#) on page 255

[CHANnel<m>:THReshold:USER](#) on page 256

[CHANnel<m>:THReshold:THReshold?](#) on page 256

[CHANnel<m>:THReshold:FINDlevel](#) on page 257

RANGE keys

The vertical RANGE keys set the vertical scale (vertical sensitivity) of the selected waveform.

In FFT mode, the RANGE keys set the scale for the amplitude range (y-axis) in the spectrum display.

In "Counter" mode, the RANGE keys set the measurement range.

Remote command:

[CHANnel<m>:SCALE](#) on page 253

[CHANnel<m>:RANGe](#) on page 253

FFT mode:

[SPECTrum:FREQuency:MAGNitude:SCALE](#) on page 305

Spectrum mode:

[SPECTrum:FREQuency:SCALE](#) on page 310

Counter mode:

[COUNter<m>:SENSe:RANGe](#) on page 363

POS keys

Move the selected signal up or down in the diagram. The position is a graphical setting given in divisions, while the offset sets a voltage.

You can also drag the channel marker on the screen.

Remote command:

[CHANnel<m>:POSition](#) on page 253

Spectrum mode:

[SPECTrum:FREQuency:POSition](#) on page 310

2.2.2 Effect of the Bandwidth Filter

Low-pass filters reduce the speed of the signal inside the instrument and cause a delay of the signal on the screen. The delay time depends on the selected filter.

The following table lists the approximate delay of the signal that is caused by various filters.

Table 2-1: Approximate signal delay dependent on the bandwidth filter

Filter	Approx. delay	Filter	Approx. delay
200 MHz	30.2 ns	500 kHz	9.07 µs
100 MHz	30.7 ns	200 kHz	22.13 µs
50 MHz	138.5 ns	100 kHz	43.87 µs
20 MHz	145 ns	50 kHz	87.47 µs
10 MHz	166.5 ns	20 kHz	218 µs
5 MHz	193 ns	10 kHz	434.7 µs
2 MHz	270.5 ns	5 kHz	869.3 µs

Filter	Approx. delay	Filter	Approx. delay
1 MHz	4.71 μ s	2 kHz	2.173 ms
		1 kHz	4.347 ms

2.3 Horizontal Setup

Horizontal settings, also known as timebase settings, adjust the display in horizontal direction.



- To set the timebase and horizontal position, use the TIME and POS keys.



- To adjust all horizontal settings, select "Horizontal" in the main menu.

The determining point of an acquisition is the trigger point. Two parameters define the position of the trigger point: reference point and horizontal position (also known as trigger offset or delay). Using these parameters, you choose the part of the waveform you want to see: around the trigger, before, or after the trigger.

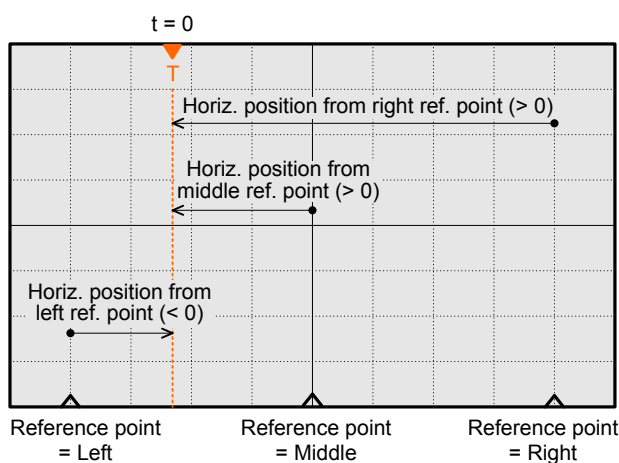

Signal delay

If you have set a bandwidth limit, the signal might appear delayed on the screen. The delay time depends on the selected filter. The effect is visible if several signals with different limits are displayed.

See also: [Chapter 2.2.2, "Effect of the Bandwidth Filter"](#), on page 41.

Description of settings



Time Scale

Sets the time scale of the horizontal axis for all signals, in seconds per division. The value is shown in the top information bar.

Increase the scale to see a longer part of the waveform. Decrease the scale to see the signal in more detail. The scale has a point that remains fixed on the screen when the scale value is changing - the reference point.

To set the time scale, you can also use the TIME keys.

Note: In FFT mode, the time scale may be restricted depending on the selected frequency span, (see "[Frequency Span](#)" on page 107).

Remote command:

[TIMEbase:SCALE](#) on page 257

[TIMEbase:RANGE](#) on page 257

Horizontal Position

Sets the horizontal position of the trigger point in relation to the reference point. The trigger position is marked by a colored triangle at the top of the diagram.

You can set the trigger point even outside the diagram and analyze the signal some time before or after the trigger. In this case, the trigger marker is shown on the left or right side of the diagram.

To set the horizontal position, you can also use the POS keys.

Remote command:

[TIMEbase:HORizontal:POSition](#) on page 257

Reference Point

Defines the time reference point in the diagram. You can set the reference point in the middle, or to the right to see the signal before the trigger. If the reference point is on the left, you see the signal after the trigger.

Remote command:

[TIMEbase:REFerence](#) on page 258

2.4 Acquisition Control

Acquisition settings define the processing of the captured samples in the instrument.



- ▶ To adjust the acquisition settings, press the ACQUIRE key, or select "Acquire" in the main menu.



- ▶ To start or stop acquisition, press the RUN STOP key.

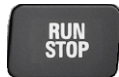

The R&S RTH captures the continuous signal and converts it to digital samples. The digital samples are processed according to the acquisition settings. The result is a waveform record that is displayed on the screen and stored in memory.

Description of settings



Acquisition Mode

Defines how the waveform is built from the captured samples. There are two general methods to build the waveform record: sample decimation and waveform arithmetic.

Sample decimation reduces the data stream of the ADC to a stream of waveform points with lower sample rate and a less precise time resolution. The R&S RTH uses decimation, if the waveform "Sampling Rate C1 - C4" is less than the ADC sample rate. The acquisition modes "Sample", "Peak Detect" and "High Resolution" are decimation methods.

Waveform arithmetic builds the resulting waveform from several consecutive acquisitions of the signal. The acquisition modes "Average" and "Envelope" are arithmetic methods.

- | | |
|---------------|--|
| "Sample" | One of n samples in a sample interval is recorded as waveform point, the other samples are discarded. Usually, most signals are displayed optimally with this acquisition mode but very short glitches might remain undiscovered by this method. |
| "Peak Detect" | The minimum and the maximum of n samples are recorded as waveform points, the other samples are discarded. Thus the instrument can detect fast signal peaks at slow time scale settings that would be missed with other acquisition modes. |

"High Resolution"	The average of n captured sample points is recorded as one waveform point. Averaging reduces the noise, the result is a more precise waveform with higher vertical resolution.
"Average"	The average is calculated from the data of the current acquisition and a number of acquisitions before. The method reduces random noise. It requires a stable, triggered and periodic signal. The number of acquisitions for average calculation is defined with Number of Averages .
"Envelope"	The minimum and maximum values in an sample interval over a number of acquisitions are saved. The most extreme values of all acquisitions build the envelope. The resulting diagram shows two envelope waveforms: the minimums (floor) and maximums (roof) representing the borders in which the signal occurs.

Remote command:

[ACQUIRE:MODE](#) on page 259

Number of Averages

Sets the number of waveforms used to calculate the average waveform.

Remote command:

[ACQUIRE:AVERAge:COUNT](#) on page 259

Reset Waveform

Restarts the envelope and average calculation.

Remote command:

[ACQUIRE:ARESet:IMMediate](#) on page 259

Acquisitions per Second

Shows the number of acquired waveforms per second.

Sampling Rate C1 - C4

Shows the number of recorded analog waveform points per second. The sample rate is the reciprocal value of the resolution.

Remote command:

[ACQUIRE:POINTs:ARATe?](#) on page 258

Sampling Rate D7 - D0

Shows the number of recorded digital waveform points per second. Only available if the mixed signal option R&S RTH-B1 is installed, and logic channels are active.

RUN STOP key

Starts and stops the acquisition.

Remote command:

[RUN](#) on page 258

[STOP](#) on page 259

2.5 Trigger

Triggering means to capture the interesting part of the relevant waveforms. Choosing the right trigger type and configuring all trigger settings correctly allows you to detect various incidents in signals.

A trigger occurs if the trigger conditions are fulfilled. The instrument acquires continuously and keeps the sample points to fill the pretrigger part of the waveform record. When the trigger occurs, the instrument continues acquisition until the posttrigger part of the waveform record is filled. Then it stops acquiring and displays the waveform. When a trigger is recognized, the instrument does not accept another trigger until the acquisition is complete.

Trigger conditions include:

- Source of the trigger signal (channel)
- Trigger type and its setup, including one or more trigger levels
- Trigger mode

In addition, the horizontal position of the trigger point and the reference point are important to display the interesting part of the signal. See [Chapter 2.3, "Horizontal Setup"](#), on page 42.

The trigger level and position are marked on the display. The markers have the color of the trigger source. Information on the most important trigger settings is shown in the upper information bar.



Figure 2-1: Trigger information: width trigger on channel 2, single trigger mode



- ▶ To adjust all trigger settings, press the SETUP key.
- ▶ To adjust the trigger level, do one of the following:
 - Drag the trigger level marker on the right side of the display to the required position.
 - Press the LEVEL key and turn the wheel.
If the trigger type has two trigger levels, press the LEVEL key again to toggle the upper and lower levels. Alternatively, press the wheel.
 - Press the SETUP key. Select "Trigger Level", and enter the level value.
- ▶ To start and stop acquisition, press the RUN STOP key.

2.5.1 General Trigger Settings

General trigger settings are the settings that are independent of the trigger type. The settings specific for a trigger type are described in the following sections.

☰ Description of settings



Trigger Mode

The trigger mode determines the behavior of the instrument if no trigger occurs, and also the number of acquired waveforms when a trigger occurs.

"Auto"	The instrument triggers repeatedly after a time interval if the trigger conditions are not fulfilled. If a real trigger occurs, it takes precedence. This mode helps to see the waveform even before the trigger is set. Successive waveforms are not triggered at the same point of the waveform.
"Normal"	The instrument acquires waveforms continuously, each time when a trigger occurs. If no trigger occurs, no waveform is acquired and the last acquired waveform is displayed. If no waveform was captured before, nothing is displayed.
"Single"	When a trigger occurs, the instrument acquires one waveform and stops the acquisition.

Remote command:

[TRIGger:MODE](#) on page 261

Trigger Type

Selects the trigger type, the event type that defines the trigger point.

- [Chapter 2.5.2, "Edge Trigger"](#), on page 49
- [Chapter 2.5.3, "Glitch Trigger"](#), on page 50
- [Chapter 2.5.4, "Width Trigger"](#), on page 51
- [Chapter 2.5.5, "Video/TV Trigger"](#), on page 53

R&S RTH-K19 trigger options

- [Chapter 2.5.7, "Pattern Trigger \(R&S RTH-K19\)"](#), on page 58
- [Chapter 2.5.8, "State Trigger \(R&S RTH-K19\)"](#), on page 60
- [Chapter 2.5.9, "Runt Trigger \(R&S RTH-K19\)"](#), on page 61
- [Chapter 2.5.10, "Slew Rate Trigger \(R&S RTH-K19\)"](#), on page 63
- [Chapter 2.5.11, "Data2Clock Trigger \(R&S RTH-K19\)"](#), on page 64

- [Chapter 2.5.12, "Serial Pattern Trigger \(R&S RTH-K19\)", on page 66](#)
- [Chapter 2.5.13, "Timeout Trigger \(R&S RTH-K19\)", on page 69](#)
- [Chapter 2.5.14, "Interval Trigger \(R&S RTH-K19\)", on page 70](#)
- [Chapter 2.5.15, "Window Trigger \(R&S RTH-K19\)", on page 71](#)

Options containing special triggers

- [Chapter 2.5.16, "Protocol Trigger \(R&S RTH-K1, R&S RTH-K2 and R&S RTH-K3\)", on page 72](#)

Remote command:

`TRIGger:TYPE` on page 261

Source

Selects the trigger source, the channel on which the trigger condition is checked. All possible channels are listed. You can trigger on any channel to which a signal is connected, even if the channel is not active.

For most trigger types, analog and digital channels can be used as trigger source. Digital channels require option R&S RTH-B1. For video, runt and slew rate trigger, only analog channels are available.

Remote command:

`TRIGger:SOURce` on page 261

Trigger Level

Sets the trigger voltage level.

For the Video/TV trigger, the trigger level is the threshold of the sync pulse. Make sure that the trigger level crosses the synchronizing pulses of the video signal.

Remote command:

`TRIGger:LEVel<m>:VALue` on page 262

Holdoff Mode

Selects the method to define the holdoff.

The trigger holdoff defines when the next trigger after the current will be recognized. Thus, it affects the next trigger to occur after the current one. Holdoff helps to obtain stable triggering when the oscilloscope is triggering on undesired events.



- "Off" No holdoff
- "Time" Defines the holdoff as a time period. The next trigger occurs only after the ["Time"](#) on page 49 has passed.
- "Events" Defines the holdoff as a number of trigger events. The next trigger only occurs when this number of events is reached. The number of triggers to be skipped is defined in ["Events"](#) on page 49.

"Random" Defines the holdoff as a random time limited by "[Min Time / Max Time](#)" on page 49. For each acquisition, the instrument selects a new random holdoff time from the specified range. Random holdoff prevents synchronization to discover effects invisible with synchronized triggering, e.g. the features of a pulse train.

Remote command:

[TRIGger:HOLDoff:MODE](#) on page 262

Time ← Holdoff Mode

Sets the time that has to pass at least until the next trigger occurs.

Remote command:

[TRIGger:HOLDoff:TIME](#) on page 263

Events ← Holdoff Mode

Sets the number of triggers to be skipped until the next trigger occurs.

Remote command:

[TRIGger:HOLDoff:EVENTs](#) on page 263

Min Time / Max Time ← Holdoff Mode

Set the time limits for random holdoff time. For each acquisition, the instrument selects a new random holdoff time from the specified range.

Remote command:

[TRIGger:HOLDoff:MIN](#) on page 263

[TRIGger:HOLDoff:MAX](#) on page 263

Noise Reject

Enables a hysteresis to avoid unwanted trigger events caused by noise oscillation around the trigger level.

Remote command:

[TRIGger:MNR](#) on page 264

2.5.2 Edge Trigger

The edge trigger is the most common trigger type. The trigger occurs when the signal from the trigger source passes the trigger level in the specified direction (slope).

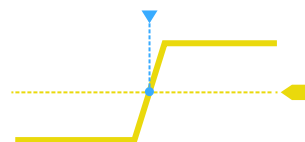

☰ Description of settings

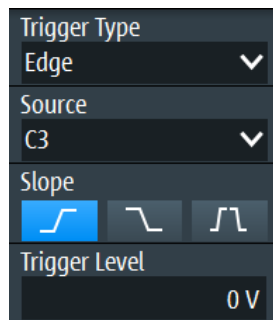





Figure 2-2: Edge trigger

Slope

Sets the edge direction for the trigger. You can trigger on:

-  rising edge, that is a positive voltage change
-  falling edge, that is a negative voltage change
-  rising and falling edge

Remote command:

[TRIGger:EDGE:SLOPe](#) on page 264

2.5.3 Glitch Trigger

The glitch trigger detects pulses shorter or longer than a specified time. It identifies deviation from the nominal data rate and helps to analyze causes of even rare glitches and their effects on other signals.

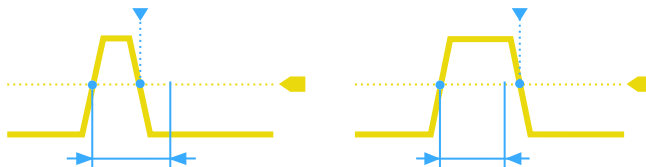

Description of settings

Trigger Type	Glitch
Source	C3
Polarity	<input checked="" type="radio"/>  <input type="radio"/>  <input type="radio"/> 
Range	Shorter
Width	4.8 ns
Trigger Level	0 V

Polarity

Sets the pulse polarity, that is the direction of the first pulse slope. You can trigger on:

- Positive going pulses. The width is defined from the rising to the falling edge.
- Negative going pulses. The width is defined from the falling to the rising edge.
- Both positive and negative going pulses

Remote command:

[TRIGger:GLITch:POLarity](#) on page 264

Range

Selects the glitches to be identified: shorter or longer than the specified "[Width](#)" on page 51.

Remote command:

[TRIGger:GLITch:RANGE](#) on page 265

Width

Sets the pulse width of the glitch.

Remote command:

[TRIGger:GLITch:WIDTH](#) on page 265

2.5.4 Width Trigger

The width trigger compares the measured pulse width (duration of a pulse) with a given time limit. It detects pulses with an exact pulse width, pulses shorter or longer than a given time, as well as pulses inside or outside the allowable time range. The pulse width is measured at the trigger level.

Using the width trigger, you can define the pulse width more precisely than with the glitch trigger. However, using the range settings "Shorter" and "Longer", you can also trigger on glitches.

☰ Description of settings



Figure 2-3: Width trigger

Polarity

Sets the pulse polarity, that is the direction of the first pulse slope. You can trigger on:

- Positive going pulses. The width is defined from the rising to the falling edge.
- Negative going pulses. The width is defined from the falling to the rising edge.
- Both positive and negative going pulses

Remote command:

`TRIGger:WIDTH:POLarity` on page 265

Range

Defines how the measured pulse width is compared with the given limits.

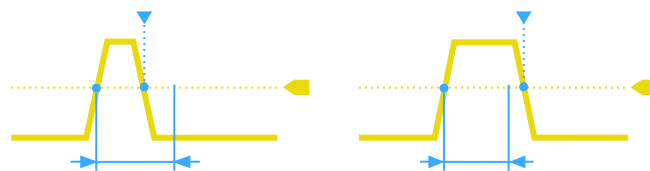

Figure 2-4: Pulse width is shorter or longer than a given width (same as glitch trigger)

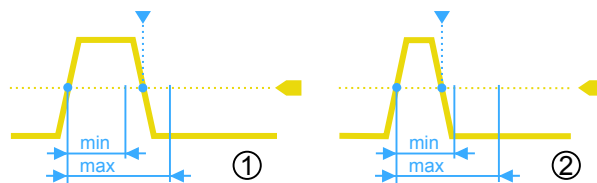

Figure 2-5: Pulse width is inside or outside a range

- 1 = Inside, pulse > min width AND pulse < max width
 2 = Outside, pulse < min width OR pulse > max width

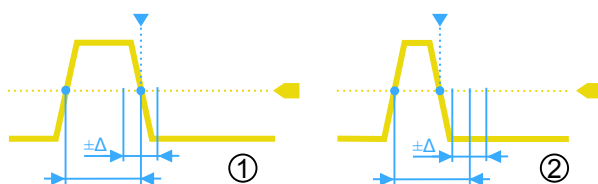

Figure 2-6: Pulse width is equal or unequal to a given width, with optional tolerance

- 1 = Equal, pulse > width - Δ AND pulse < width + Δ
 2 = Unequal, pulse < width - Δ OR pulse > width + Δ

Remote command:

[TRIGger:WIDTH:RANGe](#) on page 265

Width

Sets the width for comparisons equal, unequal, shorter, and longer.

Remote command:

[TRIGger:WIDTH:WIDTH](#) on page 266

\pm Tolerance

Sets a range Δt to the specified [Width](#) if the comparison range is equal or unequal. To trigger on an exact pulse width, set the tolerance to 0.

Remote command:

[TRIGger:WIDTH:DELTA](#) on page 266

Min Width / Max Width

Set the lower and upper time limits defining the time range if "Inside" or "Outside" is set for comparison.

Remote command:

[TRIGger:WIDTH:MIN](#) on page 267

[TRIGger:WIDTH:MAX](#) on page 266

2.5.5 Video/TV Trigger

The TV or video trigger is used to analyze analog baseband video signals. You can trigger on baseband video signals from standard definition and high definition standards, and also on user defined signals.

The instrument triggers on the line start - the horizontal sync pulse. You can trigger on all lines, or specify a line number. You can also trigger on the field or frame start.

2.5.5.1 Standard TV Trigger Settings

Access: SETUP key > "Trigger Type" = "Video/TV"

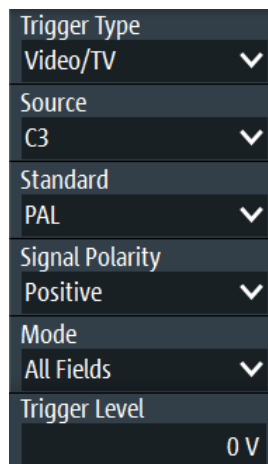

Standard

Selects the TV standard or "Custom" for user-defined signals.

The standards PAL, PAL-M, NTSC and SECAM are available in the instrument firmware. All other standards require the advance trigger option R&S RTH-K19.

HDTV standards are indicated by the number of active lines, the scanning system (p for progressive scanning, i for interlaced scanning) and the frame rate. For interlaced scanning, the field rate is used instead of the frame rate. 1080p/24sF is an HDTV standard using progressive segmented frame scanning.

"Custom" can be used for signals of other video systems, for example, medical displays, video monitors, and security cameras. To trigger on these signals, you have to define the pulse type and length of the sync pulse, the scanning system and the line period.

Remote command:

`TRIGger:TV:STANdard` on page 267

Signal Polarity

Sets the polarity of the signal. Note that the sync pulse has the opposite polarity, for example, a positive signal has a negative sync pulse.

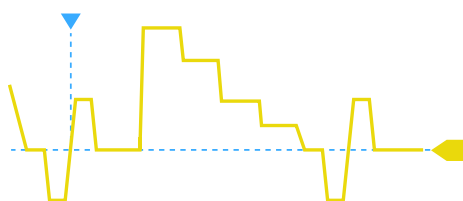

Figure 2-7: Signal with positive polarity and tri-level sync pulse

Remote command:

`TRIGger:TV:POLarity` on page 268

Mode

Selects the lines or fields on which the instrument triggers. Available modes depend on the scanning system of the selected standard.

"All fields"	Triggers on the first video line of the frame (progressive scanning) or field (interlaced scanning), for example, to find amplitude differences between the fields.
"Odd fields / Even fields"	Triggers on the first video line of the odd or even field. These modes are available for interlaced scanning (PAL, PAL-M, SECAM, NTSC, 1080i) and progressive segmented frame scanning (1080p/24sF). They can be used, for example, to analyze the components of a video signal.
"All lines"	Triggers on the line start of all video lines, for example, to find maximum video levels.
"Line number"	Triggers on a specified line. Enter the line number in "Line #".

Remote command:

`TRIGger:TV:MODE` on page 268

Line

Sets the number of the line to be triggered on if "Mode" is set to "Line number". Usually the lines of the frame are counted, beginning from the frame start.

For NTSC signals, the lines are counted per field, not per frame. Therefore, you have to set the "Field" (odd or even), and the line number in the field.

Remote command:

`TRIGger:TV:LINE` on page 269

`TRIGger:TV:LFIeld` on page 269

Trigger Level

Sets the trigger level as threshold for the synchronizing pulse. Make sure that the trigger level crosses the synchronizing pulses of the video signal.

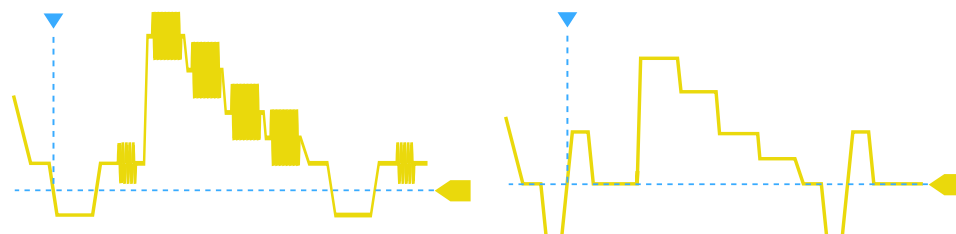

Figure 2-8: Trigger level with bi-level (left) and tri-level (right) sync pulses

Remote command:

`TRIGger:LEVel<m>:VALue` on page 262

2.5.5.2 Settings for Custom Video Signals (R&S RTH-K19)

In addition to the standard TV trigger settings, triggering on custom video signals requires a few more settings that describe the signal.

- ▶ SETUP key > "Trigger Type" = "Video/TV" > "Standard" = "Custom"

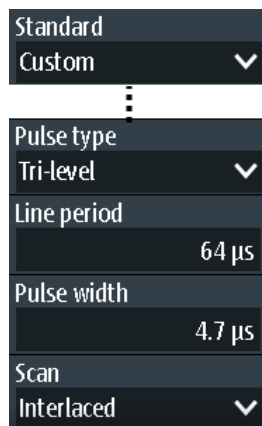

Pulse Type

Sets the type of the sync pulse, either bi-level sync pulse (used in SDTV signals), or tri-level sync pulse (used in HDTV signals).

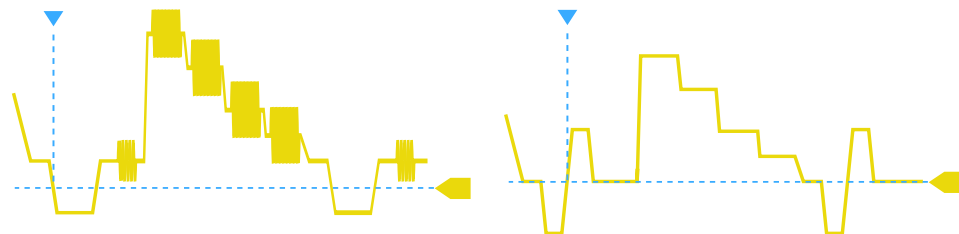

Figure 2-9: Bi-level (left) and tri-level (right) sync pulses

This setting is available for user-defined video signals if "Standard" is set to "Custom".

Remote command:

[TRIGger:TV:CUSTom:STYPe](#) on page 269

Line Period

Sets the duration of a single video line, the time between two successive sync pulses.

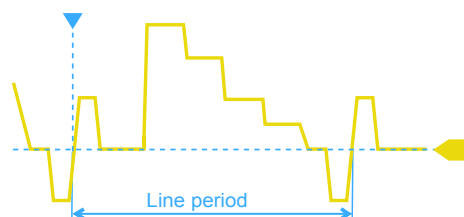

This setting is available for user-defined video signals if "Standard" is set to "Custom".

Remote command:

[TRIGger:TV:CUSTom:LDURation](#) on page 270

Pulse Width

Sets the width of the sync pulse.

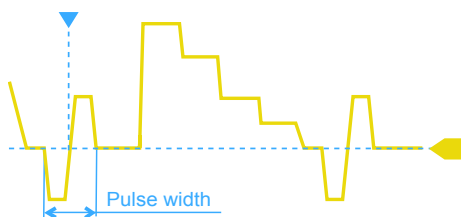

This setting is available for user-defined video signals if "Standard" is set to "Custom".

Remote command:

[TRIGger:TV:CUSTom:SDURation](#) on page 270

Scan

Sets the scanning system.

This setting is available for user-defined video signals if "Standard" is set to "Custom".

- "Interlaced" Interlace scanning uses two fields to create a frame. One field contains all the odd lines (odd, first, or upper field), the other contains all the even lines of the image (even, second, or lower field). First the lines of the odd field are processed, then the lines of the even field.
- "Progressive" Progressive scanning is a method to capture, transmit and display all lines of a frame in sequence.
- "Segmented" Progressive segmented frame uses progressive scanning to capture the frame, and interlaced scanning for transmission and display.

Remote command:

[TRIGger:TV:CUSTom:SCANmode](#) on page 270

2.5.6 External Trigger (R&S RTH1002)

The R&S RTH1002 has an edge trigger to trigger on an external signal.

1. Connect the external trigger signal to the DMM input:
 - a) Ground to black COM input.
 - b) Signal to red input.
2. Press the SETUP key.
3. Select "Trigger Type" = "External"

 **Description of settings**



Slope

Sets the edge direction for the trigger. You can trigger on the rising edge, the falling edge, or rising and falling edges of the external signal.

Remote command:

`TRIGger:EXTernal:SLOPe` on page 271

Trigger Level

Sets the trigger voltage level.

Remote command:

`TRIGger:EXTernal:LEVel` on page 270

2.5.7 Pattern Trigger (R&S RTH-K19)

The pattern trigger works like a logic trigger. It provides logical combinations of the input channels and can be used for verifying the operation of digital logic. If the channel states match the desired pattern, the pattern trigger occurs. In addition to the pattern, you can define a timing condition. In this case, the trigger occurs if the pattern definition is true for the defined time.

The pattern trigger has no trigger level, only threshold values to obtain the logic state of signals are required.

- ▶ SETUP key > "Trigger Type" = "Pattern"

**Description of settings**

Figure 2-10: Pattern trigger

Set Pattern

Defines the pattern: the states of the input channels and their logical combination. If R&S RTH-B1 is installed, active digital channels are also included in the pattern definition.

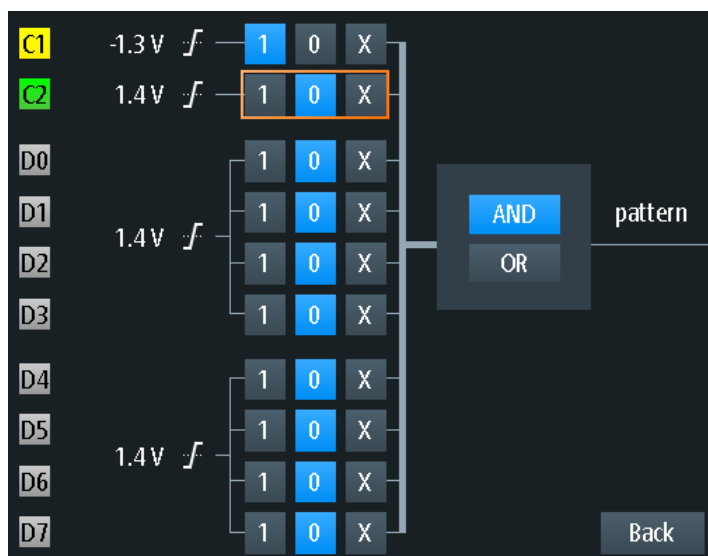

Figure 2-11: Pattern definition

The current threshold is displayed for each channel. For analog channels, the threshold is set in the "Vertical" menu > "Technology". For logic channels, the threshold is set in the "Logic" menu. To adjust the thresholds by the instrument, use "Find Level".

The switches define the state of each channel and set the logical combination:

- "1" The signal value is above the defined threshold.
- "0" The signal value is below the defined threshold.
- "X" The signal state does not matter.
- "AND" If all defined states are true, the logical result of the pattern definition is 1 (true).
- "OR" If at least one of the defined states is true, the logical result of the pattern definition is 1 (true).

Remote command:

[TRIGger:PATtern:STATe\[:CHANnel<m>\]](#) on page 271

[TRIGger:PATtern:STATe:COMBination](#) on page 271

Range

Adds additional time limitation to the defined pattern.

- "None" No time limit is set. If the defined pattern is true, the pattern trigger occurs.
- "Timeout" Defines a minimum time during which the signals match the pattern definition.
- "Longer" If the pattern is true longer than the "Pattern Width" time, the trigger occurs.
- "Shorter" If the pattern is true for a time shorter than "Pattern Width", the trigger occurs.
- "Equal" If the pattern is true for the time "*Pattern Width*" $\pm \Delta t$ ("*Tolerance*"), the trigger occurs.

"Unequal"	If the pattern is true for a time shorter than " <i>Pattern Width</i> " - Δt OR longer than " <i>Pattern Width</i> " + Δt , the trigger occurs.
"Inside"	If the pattern is true for a time between "Min Pattern Width" and "Max Pattern Width", the trigger occurs.
"Outside"	If the pattern is true for a time shorter than "Min Pattern Width" OR longer than "Max Pattern Width", the trigger occurs.

Remote command:

[TRIGGER:PATTERN:WIDTH:RANGE](#) on page 272

[TRIGGER:PATTERN:TIMEout\[:TIME\]](#) on page 272

[TRIGGER:PATTERN:WIDTH\[:WIDTH\]](#) on page 272

[TRIGGER:PATTERN:WIDTH:DELTA](#) on page 273

[TRIGGER:PATTERN:WIDTH:MINwidth](#) on page 273

[TRIGGER:PATTERN:WIDTH:MAXwidth](#) on page 273

2.5.8 State Trigger (R&S RTH-K19)

The state trigger verifies if the channel states match the defined pattern at the clock edge. The trigger occurs if the logical combination of the input channels is true at the crossing point of the selected clock edge and the trigger level.

- ▶ SETUP key > "Trigger Type" = "State"



Description of settings

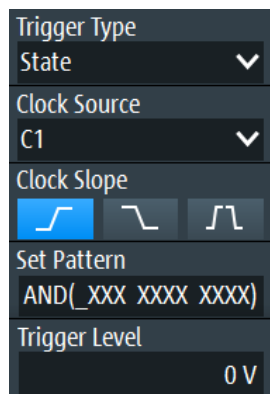

Figure 2-12: State trigger

Clock Source

Selects the input channel of the clock signal.

Remote command:

[TRIGGER:STATe:CSourCe\[:VALue\]](#) on page 274

Clock Slope

Sets the edge of the clock at which the instrument checks the signal states: at the rising edge, the falling edge, or at both edges.

Remote command:

`TRIGger:STATe:CSOURCE:EDGE` on page 274

Set Pattern

Defines the pattern: the states of the input channels and their logical combination. If R&S RTH-B1 is installed, active digital channels are also included in the pattern definition.

For details, see [Chapter 2.5.7, "Pattern Trigger \(R&S RTH-K19\)"](#), on page 58.

Remote command:

`TRIGger:STATe:CHANnel<m>` on page 274

`TRIGger:STATe:COMBination` on page 274

2.5.9 Runt Trigger (R&S RTH-K19)

A runt is a pulse lower than normal in amplitude. The amplitude crosses the first level twice in succession without crossing the second one. In addition to the upper and lower levels, you can define a time limit for the runt in the same way as for width triggers. For example, the runt trigger can detect signal parts remaining below a specified threshold amplitude because I/O ports are in undefined state.

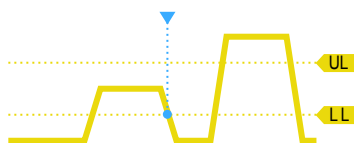

Figure 2-13: Runt trigger without time limits

- ▶ SETUP key > "Trigger Type" = "Runt"

Description of settings

Trigger Type	Runt		
Source	C1		
Polarity	<input checked="" type="checkbox"/> <input type="checkbox"/> <input type="checkbox"/>		
Range	Longer	Equal	Inside
Upper Trigger Level	Runt Width	Runt Width	Min Runt Width
0 V	4.8 ns	4.8 ns	4 ns
Lower Trigger Level	Upper Trigger Level	±Tolerance	Max Runt Width
0 V	0 V	800 ps	5.6 ns
	Lower Trigger Level	Upper Trigger Level	Upper Trigger Level
	0 V	0 V	0 V
		Lower Trigger Level	Lower Trigger Level
		0 V	0 V

Upper Trigger Level / Lower Trigger Level

Set the upper and lower voltage thresholds for the runt trigger. The levels define the minimum and maximum runt amplitudes.

You can also press the LEVEL key to toggle the upper and lower levels, and turn the wheel to adjust the focused level. If the focus is on a trigger level, pressing the wheel also toggles the levels.

Remote command:

[TRIGger:LEVel<m>:RUNT:UPPer](#) on page 275

[TRIGger:LEVel<m>:RUNT:LOWer](#) on page 275

Polarity

Sets the pulse polarity, that is the direction of the first pulse slope. You can trigger on:

- Positive going pulses. The width is defined from the rising to the falling edge.
- Negative going pulses. The width is defined from the falling to the rising edge.
- Both positive and negative going pulses

Remote command:

[TRIGger:RUNT:POLarity](#) on page 275

Range

Defines an additional time limit of the runt pulse.

"Any runt" triggers on all runts fulfilling the level condition, without time limitation. The other comparisons are the same as for the width trigger, see "[Range](#)" on page 52.

Remote command:

[TRIGger:RUNT:RANGe](#) on page 275

Runt Width

Sets the width for comparisons equal, unequal, shorter, and longer.

Remote command:

[TRIGger:RUNT:WIDTh](#) on page 276

±Tolerance

Sets a tolerance range Δt to the specified [Runt Width](#) if the comparison range is equal or unequal.

Remote command:

[TRIGger:RUNT:DELTA](#) on page 276

Min Runt Width / Max Runt Width

Set the lower and upper time limits if "Inside" or "Outside" is set for comparison.

Remote command:

[TRIGger:RUNT:MINWidth](#) on page 276

[TRIGger:RUNT:MAXWidth](#) on page 277

2.5.10 Slew Rate Trigger (R&S RTH-K19)

The slew rate trigger is also known as transition trigger. It triggers if the transition time from the lower to higher voltage level (or vice versa) is shorter or longer as defined, or outside or inside a specified time range.

The slew rate trigger finds slew rates faster than expected or permissible to avoid overshooting and other interfering effects. It also detects slow edges violating the timing in pulse series.

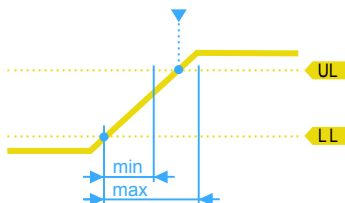

Figure 2-14: Slew rate trigger, transition time inside a range ($t > \text{min time AND } t < \text{max time}$)

- ▶ SETUP key > "Trigger Type" = "Slew rate"

As source, only analog channels are available.



Description of settings

Trigger Type	Slew Rate	
Source	C1	
Slope		
Range	Shorter	
Time	4.8 ns	
Upper Trigger Level	0 V	
Lower Trigger Level	0 V	
Range	Equal	
Time	4.8 ns	
±Tolerance	800 ps	
Upper Trigger Level	0 V	
Lower Trigger Level	0 V	
Range	Inside	
Min Time	4 ns	
Max Time	5.6 ns	
Upper Trigger Level	0 V	
Lower Trigger Level	0 V	

Upper Trigger Level / Lower Trigger Level

Set the upper and lower voltage thresholds for the slew rate trigger. The time measurement starts when the signal crosses the first trigger level, and stops when the signal crosses the second level. The first trigger level is the upper or lower level depending on the selected slope.



Remote command:

`TRIGger:LEVel<m>:SLEW:UPPer` on page 277

`TRIGger:LEVel<m>:SLEW:LOWer` on page 277

Slope

Sets the edge direction for the trigger. You can trigger on:

-  rising edge, that is a positive voltage change
-  falling edge, that is a negative voltage change
-  rising and falling edge

Remote command:

`TRIGger:SLEW:SLOPe` on page 277

Range

Defines the time limits of the slew rate. The comparisons are the same as for the width trigger, see "Range" on page 52.

Remote command:

`TRIGger:SLEW:RANGe` on page 277

Time

Sets the slew rate for comparisons equal, unequal, shorter, and longer.

Remote command:

`TRIGger:SLEW:RATE` on page 278

±Tolerance

Sets a tolerance range Δt to the specified Time if the comparison range is equal or unequal.

Remote command:

`TRIGger:SLEW:DELTA` on page 278

Min Time / Max Time

Set the lower and upper time limits if "Inside" or "Outside" is set for comparison.

Remote command:

`TRIGger:SLEW:MINwidth` on page 278

`TRIGger:SLEW:MAXwidth` on page 279

2.5.11 Data2Clock Trigger (R&S RTH-K19)

With the Data2Clock trigger - also known as setup/hold trigger - you can analyze the relative timing between two signals: a data signal and the synchronous clock signal. Many systems require, that the data signal must be steady for some time before and after the clock edge, for example, the data transmission on parallel interfaces.

The reference point for the time measurement is defined by clock level and clock edge.

- ▶ SETUP key > "Trigger Type" = "Data2Clk"

Description of settings

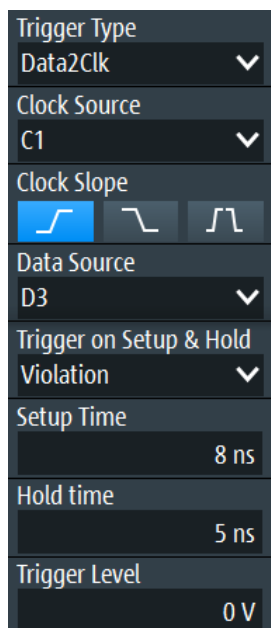

Figure 2-15: Data2Clock trigger

Clock Source

Selects the input channel of the clock signal.

Remote command:

[TRIGger:DATatoclock:CSource\[:VALue\]](#) on page 279

Clock Slope

Sets the edge of the clock signal: rising, falling, or both edges. The time reference point for the setup and hold time is the crossing point of the clock edge and the trigger level.

Remote command:

[TRIGger:DATatoclock:CSource:EDGE](#) on page 279

Data Source

Selects the input channel of the data signal.

Remote command:

[TRIGger:DATatoclock:DSource\[:VALue\]](#) on page 279

Trigger on Setup & Hold

Selects how a violation of the setup and hold time is handled.

"Violation" Triggers on a violation of the setup or hold time

"OK" Triggers if setup and hold time keep the limits.

Remote command:

[TRIGger:DATatoclock:CONDition](#) on page 279

Setup Time

Sets the minimum time before the clock edge while the data signal must stay steady.

The setup time can be negative. In this case, the hold time is always positive. If you set a negative setup time, the hold time is adjusted by the instrument.

Remote command:

`TRIGger:DATatoclock:STIME` on page 280

Hold Time

Sets the minimum time after the clock edge while the data signal must stay steady.

The hold time can be negative. In this case, the setup time is always positive. If you set a negative hold time, the setup time is adjusted by the instrument.

Remote command:

`TRIGger:DATatoclock:HTIME` on page 280

2.5.12 Serial Pattern Trigger (R&S RTH-K19)

The serial pattern event is used to trigger on signals with serial data patterns in relation to a clock signal - for example, on bus signals like the I²C bus. The trigger occurs during the reception of the last bit of the defined pattern.

2.5.12.1 Pattern Definition

The pattern defines the bits of the serial data to be found in the data stream.



The pattern definition described here is for the serial pattern trigger; however, a very similar pattern editor is available for other functions, such as protocol-specific triggers.

When you tap the pattern field, a pattern editor is displayed. The current bit definition in binary and hexadecimal format is displayed at the top of the editor, a virtual keypad is displayed beneath it. To define a bit, select the bit in the displayed pattern, then select the bit value from the displayed keypad. The currently selected bit is indicated by a blue background.



Figure 2-16: Pattern editor for 14-bit pattern in hexadecimal format

The maximum length of the pattern is 32 bit, however you can reduce the number of bits. The available bits are initially indicated by 'X', while the unused bits are indicated by gray squares. An 'X' indicates that the logical level for the bit is not relevant (do not care). Once you enter a value for the selected bit, the 'X' is overwritten.

You can enter the pattern in binary or hexadecimal format. Depending on which bit you select in the pattern display, binary or hexadecimal format is automatically selected for input. In binary format, each bit is defined individually, and only the digits 0 and 1 are available for input. In hexadecimal format, 4 bits are defined at the same time by the selected hexadecimal value. If fewer than 4 bits are available (due to the total number of bits), only those hexadecimal values are available that can be defined with the remaining number of bits. For example, for a total number of 14 bits, 3x4 bits can be defined by any hexadecimal value. The remaining 2 bits can define a 0, 1, 2, or 3 (as shown in Figure 2-16).

To store the defined pattern, select "Enter". The pattern editor is closed and the pattern is inserted in the pattern settings field.

2.5.12.2 Serial Pattern Trigger Settings

Access: (Trigger) SETUP key > "Trigger Type" = "Serial Pattern"

☰ Description of settings

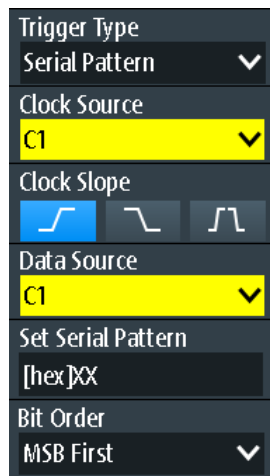

Figure 2-17: Serial pattern trigger

Clock Source.....	68
Clock Slope.....	68
Data Source.....	68
Set Serial Pattern.....	68
Bit Order.....	69

Clock Source

Selects the input channel of the clock signal.

Remote command:

[TRIGger:SPATtern:CSourCe\[:VALue\]](#) on page 281

Clock Slope

Sets the edge at which the data value is sampled.

- rising edge
- falling edge
- rising and falling edges are considered (double data rate).

At double data rate, "First Clock Edge of Pattern" defines the edge at which the first bit of the pattern is sampled: at the rising clock edge, falling clock edge, or the first edge that is detected ("Either").

Remote command:

[TRIGger:SPATtern:CSourCe:EDGE](#) on page 281

[TRIGger:SPATtern:CSourCe:FIRStedge](#) on page 281

Data Source

Selects the input channel of the data signal.

Remote command:

[TRIGger:SPATtern:DSourCe\[:VALue\]](#) on page 280

Set Serial Pattern

The pattern defines the bits of the serial data to be found in the data stream.

See also [Chapter 2.5.12.1, "Pattern Definition"](#), on page 66.

Remote command:

[TRIGger:SPATtern:PATtern](#) on page 281

Bit Order

Defines if the data words start with MSB (most significant bit) or LSB (least significant bit).

Remote command:

[TRIGger:SPATtern:ORDer](#) on page 281

2.5.13 Timeout Trigger (R&S RTH-K19)

The timeout trigger checks if the signal stays above or below the trigger level for a specified time lapse. In other words, the trigger occurs if the signal does not cross the trigger level during the specified time.

- ▶ SETUP key > "Trigger Type" = "Timeout"



Description of settings

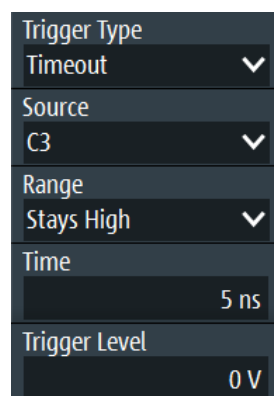

Figure 2-18: Timeout trigger

Range

Selects the relation of the signal level to the trigger level:

- "Stays High" The signal level stays above the trigger level.
- "Stays Low" The signal level stays below the trigger level.
- "High or Low" The signal level stays above or below the trigger level.

Remote command:

[TRIGger:TIMEout:RANGe](#) on page 282

Time

Defines the time limit for the timeout at which the instrument triggers.

Remote command:

[TRIGger:TIMEout:TIME](#) on page 282

2.5.14 Interval Trigger (R&S RTH-K19)

The interval trigger analyzes the time between two pulses.

- ▶ SETUP key > "Trigger Type" = "Interval"

Description of settings



Figure 2-19: Interval trigger

Slope

Sets the edge for the trigger. You can analyze the interval between positive edges or between negative edges.

Remote command:

[TRIGger:INTerval:SLOPe](#) on page 282

Range

Defines how the time range of an interval is defined. The comparisons are the same as for the width trigger, see "[Range](#)" on page 52.

Remote command:

[TRIGger:INTerval:RANGe](#) on page 283

Interval Width

Sets the time between two pulses for comparisons equal, unequal, shorter, and longer.

Remote command:

[TRIGger:INTerval:WIDTh](#) on page 283

±Tolerance

Sets a tolerance range Δt to the specified [Interval Width](#) if the comparison range is equal or unequal.

Remote command:

[TRIGger:INTerval:DELTA](#) on page 283

Min Interval Width / Max Interval Width

Set the lower and upper time limits of the interval if "Inside" or "Outside" is set for comparison.

Remote command:

[TRIGger:INTerval:MINWidth](#) on page 283

[TRIGger:INTerval:MAXWidth](#) on page 284

2.5.15 Window Trigger (R&S RTH-K19)

The window trigger checks the signal run in relation to a "window" that is formed by the upper and lower voltage levels. The trigger occurs, if the waveform enters or leaves the window, or if the waveform stays inside or outside for a defined time range.

With the window trigger, you can display longer transient effects.

- ▶ SETUP key > "Trigger Type" = "Window"

**Description of settings**

Figure 2-20: Window trigger

Vertical Condition

Selects how the signal run is compared with the window:

- | | |
|----------------|--|
| "Enter" | Triggers when the signal crosses the upper or lower level and thus enters the window made up of these two levels. |
| "Exit" | Triggers when the signal leaves the window. |
| "Stay Inside" | Triggers if the signal stays between the upper and lower level for a specified time. The time is defined in various ways by the "Range" conditions. |
| "Stay Outside" | Triggers if the signal stays above the upper level or below the lower level for a specified time. The time is defined in various ways by the "Range" conditions. |

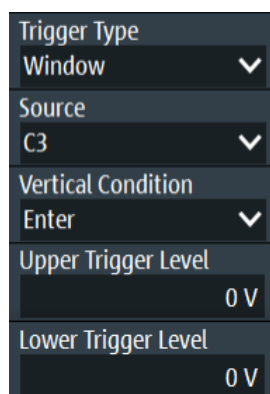
Remote command:

[TRIGger:WINDow:RANGe](#) on page 285

Upper Trigger Level / Lower Trigger Level

Set the upper and lower voltage thresholds for the window trigger. The trigger levels are the vertical window limits.

Remote command:

[TRIGger:LEVel<m>:WINDow:UPPer](#) on page 284

[TRIGger:LEVel<m>:WINDow:LOWer](#) on page 284

Range

Selects how the time limit of the window is defined. Time conditioning is available for the vertical conditions "Stay Inside" and "Stay Outside".

"Longer"	Triggers if the signal crosses the upper or lower level after the specified "Width" time is reached.
"Shorter"	Triggers if the signal crosses the upper or lower level before the specified "Width" time is reached.
"Equal"	Triggers if the signal stays inside or outside the vertical window limits for the time "Width" "±Tolerance".
"Unequal"	Triggers if the signal stays inside or outside the vertical window limits for a time unequal to "Width" "±Tolerance"
"Inside"	Triggers if the signal stays inside or outside the vertical window limits at least for the time "Min Width" and for "Max Width" at the most.
"Outside"	"Outside" is the opposite definition of "Inside". The trigger occurs if the signal stays inside or outside the vertical window limits for a time shorter than "Min Width" or longer than "Max Width".

Remote command:

[TRIGger:WINDow:TIME](#) on page 284

[TRIGger:WINDow:WIDTH](#) on page 285

[TRIGger:WINDow:DELTA](#) on page 286

[TRIGger:WINDow:MINWidth](#) on page 286

[TRIGger:WINDow:MAXWidth](#) on page 286

2.5.16 Protocol Trigger (R&S RTH-K1, R&S RTH-K2 and R&S RTH-K3)

The protocol trigger requires at least one of the serial protocol options.

For protocol setup and trigger settings, see:

- [Chapter 8.2.3, "I2C Trigger Settings"](#), on page 170
- [Chapter 8.3.3, "SPI Trigger Settings"](#), on page 178
- [Chapter 8.4.3, "UART Trigger Settings"](#), on page 184
- [Chapter 8.5.2, "CAN Trigger Settings"](#), on page 188
- [Chapter 8.6.3, "LIN Trigger Settings"](#), on page 199

3 Waveform Analysis

3.1 Zoom

The zoom magnifies a part of the waveform in order to view more details with a maximum zoom factor of 100.



To activate the zoom:

- ▶ Press the ZOOM key.

The zoom is applied to all active analog and digital channels and math waveforms. The waveforms are displayed with a shorter time scale while the vertical scale remains unchanged. The zoom indicator on the bottom shows the size and position of the zoom area in the waveform.

To adjust the zoom using the wheel:

1. Check if the zoom has the focus - an orange frame on the zoom indicator. If not, press the ZOOM key.

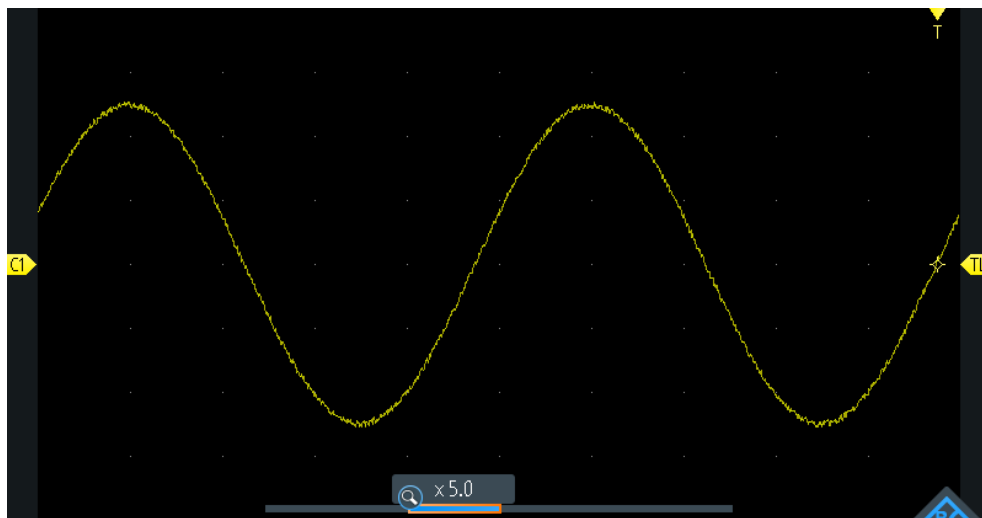

Figure 3-1: Zoomed waveform and zoom indicator with focus on zoom factor



Figure 3-2: Zoom indicator with focus on zoom position

2. Turn the wheel.
Depending on the focus, the position of the zoom area or the zoom factor is adjusted.
3. Press the wheel to toggle the setting.

- Turn the wheel to adjust the other parameter.

To position the zoom on the touchscreen:

- ▶ Use one of these methods:
 - Drag the zoom area in the zoom indicator.
 - Drag the trigger position marker.
In zoom mode, moving the trigger position marker changes the zoom position and not the horizontal position of the waveform.

To zoom in and out using pinching & spreading gestures

You can zoom in and out as you do on a mobile phone or tablet.

- To zoom in, touch the screen with two fingers and spread the fingers.
- To zoom out, touch the screen with two fingers and pinch them together.

To adjust the zoom numerically in the Zoom menu:

- Press and hold the ZOOM key until the "Zoom" menu opens.
- Adjust scale and position of the zoom in the menu.

To analyze the zoomed signal, you can use cursor measurements.

Description of settings

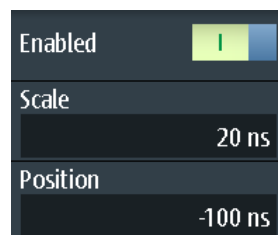

Enabled

Enables or disables the zoom.

Remote command:

[ZOOM:ENABLE](#) on page 286

Scale

Sets the time scale of the zoomed waveform.

$$Timebase_{zoom} = Timebase_{wfm} / Zoom\ factor$$

Remote command:

[ZOOM:SCALE](#) on page 287

Position

Sets the center position of the zoomed area in relation to the trigger point.

Note: The zoom overview also considers the horizontal position of the trigger point. If the horizontal position is $\neq 0$ and thus the trigger point is not in the middle, the zoom area in the overview is also shifted, even if the zoom position is 0.

Remote command:

`ZOOM:POSition` on page 287

3.2 Automatic Measurements

You can perform up to four different measurements simultaneously.

3.2.1 Performing Automatic Measurements

To start and stop the last configured measurements

- ▶ Press the MEAS key.

To configure automatic measurements in the Meas menu

1. Press and hold the MEAS key until the "Meas" menu opens.
2. Select the number of the measurement that you want to configure.
3. If the measurement is disabled, enable "State".
4. Select the "Type".
The selection list shows all available measurement types.
5. Select the "Source".
The selection list shows all active sources that are allowed for the selected measurement type.
6. Some measurement types require additional settings. Scroll down the menu and adjust the additional settings if necessary.

3.2.2 Measurement Results

The measurement results are shown on the left-top side of the screen.

C1	T = 100.1 ns	C2	Mean = 2.876 μ V
C3	RMS = 35.37 mV	C4	Dty+ = 50.00 %

Figure 3-3: Results of 4 active measurements

If a result cannot be determined, "---" is displayed. Adjust the horizontal and vertical settings if the instrument cannot measure.

If the measurement result is outside the measurement range and clipping occurs, the results are marked with < (underflow) or > (overflow). Adjust the vertical scale to get valid results.

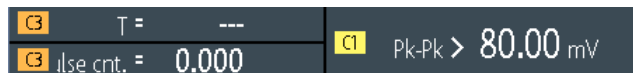

Figure 3-4: Invalid measurement results

Meas1 = period measurement on C3, no complete period detected
 Meas2 = peak to peak measurement on C1, waveform is clipped
 Meas3 = pulse count on C3, no pulse detected

Remote commands:

- [MEASurement<m>:RESult:ACTual?](#) on page 289
- [MEASurement<m>:RESult:LIMit?](#) on page 289

3.2.3 Measurement Types

The R&S RTH provides 35 measurement types to measure time, amplitude and power characteristics, and to count pulses and edges.

All measurement types that require only one source are also available for gated measurements using `CURSORS > "Type" = "Measure"`.

3.2.3.1 Time Measurements

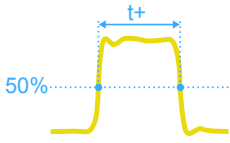
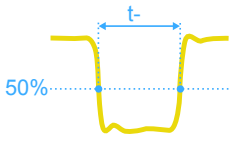
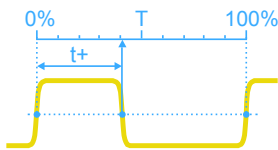
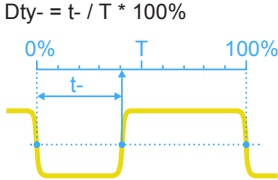
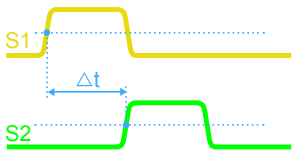
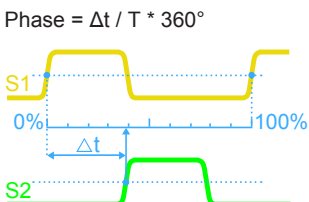

Meas. type	Symbol	Description	Graphic / formula	Source
Period	T in s	Time of the first period, measured on the 50% level. The measurement requires at least one complete period of the signal.		Analog, math, reference, logic
Frequency	f in Hz	Frequency of the signal, reciprocal value of the measured first period.		Analog, math, reference, logic
Rise time	tR in s	Rise time of the first rising edge. This is the time it takes the signal to rise from the 10% level to the 90% level.		Analog, math, reference
Fall time	tF in s	Fall time of the first falling edge. This is the time it takes the signal to fall from the 90% level to the 10% level.		Analog, math, reference

Meas. type	Symbol	Description	Graphic / formula	Source
Positive pulse width	t+ in s	Duration of the first positive pulse: time between a rising edge and the following falling edge measured on the 50% level.		Analog, math, reference, logic
Negative pulse width	t- in s	Duration of the first negative pulse: time between a falling edge and the following rising edge measured on the 50% level.		Analog, math, reference, logic
Positive duty cycle	Dty+ in %	Width of the first positive pulse in relation to the period in %. The measurement requires at least one complete period of the signal.	$Dty+ = t+ / T * 100\%$ 	Analog, math, reference, logic
Negative duty cycle	Dty- in %	Width of the first negative pulse in relation to the period in %. The measurement requires at least one complete period of the signal.	$Dty- = t- / T * 100\%$ 	Analog, math, reference, logic
Delay	Δt in s	Time difference between two slopes of the same or different waveforms, measured on the 50% level. Not available for cursor measurements		2 sources: analog, math, reference, logic
Phase	\angle in °	Phase difference between two waveforms, measured on the 50% level. Not available for cursor measurements	$Phase = \Delta t / T * 360^\circ$ 	2 sources: analog, math, reference, logic

3.2.3.2 Amplitude Measurements

The unit of most amplitude measurement results depends on the measured source.

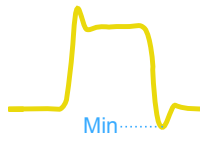
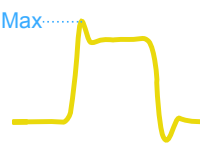
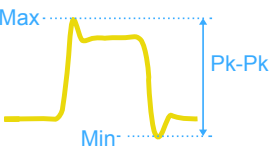
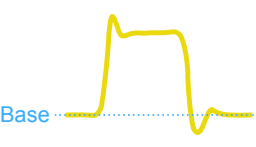
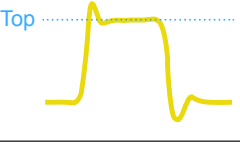
Meas. type	Symbol	Description	Graphic / formula	Source
Mean value	Mean	Arithmetic average of the complete displayed waveform.	$Mean = \frac{1}{N} \sum_{k=1}^N x_k$	analog, math, reference, logic
RMS value	RMS	RMS (Root Mean Square) value of the voltage of the complete displayed waveform.	$RMS = \sqrt{\frac{1}{N} \sum_{k=1}^N x_k^2}$	analog, math, reference

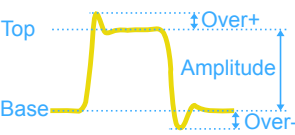
Meas. type	Symbol	Description	Graphic / formula	Source
Crest factor	Crest	The crest factor is also known as peak-to-average ratio. It is the maximum value divided by the RMS value of the displayed waveform.	$\text{Crest} = \frac{\text{Max} x_k }{\text{RMS}}$	analog, math, reference
Standard deviation	σ	Standard deviation of the displayed waveform.	$\sigma = \sqrt{\frac{1}{N-1} \sum_{k=1}^N (x_k - \text{Mean})^2}$	analog, math, reference
Minimum	Min	Minimum value within the displayed waveform.		analog, math, reference
Maximum	Max	Maximum value within the displayed waveform.		analog, math, reference
Peak to peak	Pk-Pk	Difference of maximum and minimum values.		analog, math, reference
Base level	Base	Low level of the displayed waveform - the lower maximum of the sample distribution. The measurement requires at least one complete period of the signal.		analog, math, reference
Top level	Top	High level of the displayed waveform - the upper maximum of the sample distribution. The measurement requires at least one complete period of the signal.		analog, math, reference
Amplitude	Amp	Difference between the top level and the base level of the signal. The measurement requires at least one complete period of the signal.		analog, math, reference
Overshoot	Over in %	Overshoot of a square wave <i>after</i> a rising or falling edge. It is calculated from measurement values top level, base level, local maximum, local minimum, and amplitude.	$\text{Over}+ = \frac{\text{Max}_{\text{local}} - \text{Top}}{\text{Amplitude}} \cdot 100\%$ $\text{Over}- = \frac{\text{Base} - \text{Min}_{\text{local}}}{\text{Amplitude}} \cdot 100\%$ 	analog, math, reference

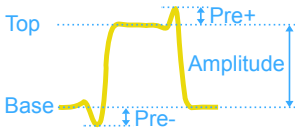
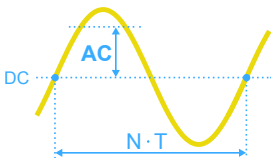
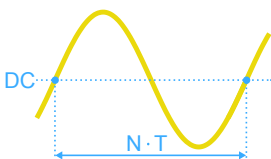
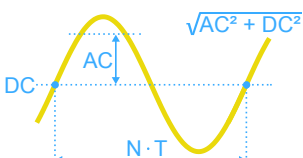
Meas. type	Symbol	Description	Graphic / formula	Source
Preshoot	Pre in %	Overshoot of a square wave <i>before</i> a rising or falling edge.	Same equations as overshoot 	analog, math, reference
AC	AC in V	RMS value of the AC part of a periodic signal, calculated over all periods on the display. The AC result is derived from the DC and AC+DC results.		analog, math, reference
DC	DC in V	Mean value of a periodic signal, calculated over all periods on the display. If no complete period is available, only the mean value of the visible waveform is calculated.		analog, math, reference
AC+DC	AC+DC in V	RMS value of a periodic signal, calculated over all periods on the display. If no complete period is available, only the RMS value of the visible waveform is calculated.		analog, math, reference

3.2.3.3 Counting

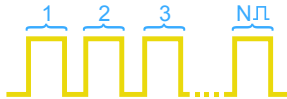
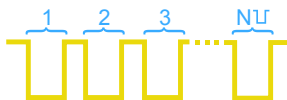
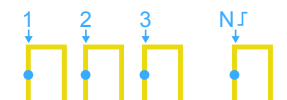
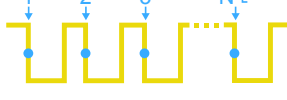
Meas. type	Symbol	Description	Graphic / formula	Sources
Positive pulse count	Cnt+	Number of positive pulses on the display. The mean value of the signal is determined. If the signal passes the mean value, an edge is counted. A positive pulse is counted if a rising edge and a following falling edge are detected.		Analog, math, reference, logic
Negative pulse count	Cnt-	Number of negative pulses on the display. The mean value of the signal is determined. If the signal passes the mean value, an edge is counted. A negative pulse is counted if a falling edge and a following rising edge are detected.		Analog, math, reference, logic
Rising edge count	Cnt↑	Number of rising edges on the display. The instrument determines the mean value of the signal and counts an edge every time the signal passes the mean value in the specified direction.		Analog, math, reference, logic
Falling edge count	Cnt↓	Number of falling edges on the display. The instrument determines the mean value of the signal and counts an edge every time the signal passes the mean value in the specified direction.		Analog, math, reference, logic

3.2.3.4 Power Measurements

Power measurements require two sources, one voltage source and one current source. They are not available for cursor measurements and logic channel sources.

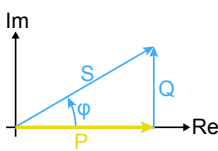
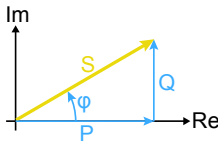
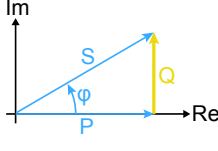
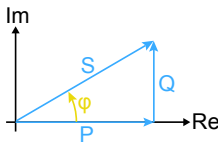
Meas. type	Symbol	Description	Graphic / formula	Sources
Active power	P in W	Active or real power is the energy of the system that can be used to do work.		2 sources: analog, math, reference
Apparent power	S in VA	Complex power S is the magnitude of the vector sum of real and reactive power.		2 sources: analog, math, reference
Reactive power	Q in var	Reactive power is temporally stored in a system because of the inductive and capacitive elements.		2 sources: analog, math, reference
Power factor	PF (no unit)	Power factor is a measure of the system efficiency. The value varies between -1 and 1.	PF = cos(phi) 	2 sources: analog, math, reference

3.2.4 Measurement Settings

Access: "Meas" menu

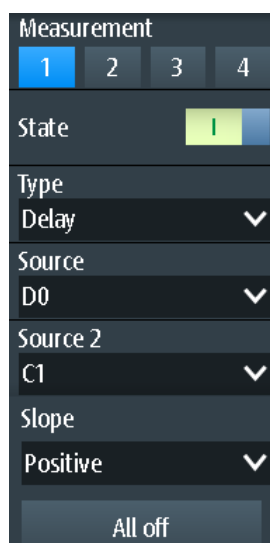

Measurement

Selects the measurement to be configured in the menu. You can perform up to four different measurements simultaneously.

State

Enables or disables the selected measurement.

Remote command:

`MEASurement<m>:ENABle` on page 287

Type

Selects the measurement type. For a detailed description, see [Chapter 3.2.3, "Measurement Types"](#), on page 76.

Remote command:

`MEASurement<m>:TYPE` on page 288

Source / Source 2

Defines the waveform to be measured. For delay, phase, and power measurements, 2 sources are required.

The sources can be any active input signal, math or reference waveform. Available source waveforms depend on the measurement type, see [Chapter 3.2.3, "Measurement Types"](#), on page 76.

Remote command:

`MEASurement<m>:SOURce` on page 288

All off

Disables all active measurements.

Remote command:

`MEASurement<m>:AOFF` on page 289

Slope

Sets the slope for the delay measurement type.

"Positive" Delay between the first rising edge of each source waveform.

"Negative" Delay between the first falling edge of each source waveform.

"Either" Delay between the first edge of each source waveform, no matter if it is rising or falling.

Remote command:

`MEASurement<m>:DELay:SLOPe` on page 289

3.3 Cursor Measurements

The cursor measurement determines the results at the current cursor positions, or performs gated automatic measurements between the cursor lines. The cursors can be positioned manually at fixed positions, or they can follow the waveform.

You can perform cursor measurements on analog input signals, math waveform, XY-diagram, as well as on logic channels (requires option R&S RTH-B1).

Cursor measurements on spectrum displays are also available, if the option R&S RTH-K18 is installed (see [Chapter 5.2.7, "Cursor Measurements on Spectrums"](#), on page 120).

3.3.1 Performing Cursor Measurements

To start and stop the last configured measurement

- ▶ Press the CURSOR key.

To configure the cursor measurement in the Cursor menu

1. Press and hold the CURSOR key until the "Cursor" menu opens.
2. Select the "Type" of the cursor.
3. For horizontal, track and measure types, select the "Source" channel that you want to measure.
4. Scroll down the menu and adjust the additional settings, which are required for the selected cursor type.

3.3.2 Cursor Types and Results

The results of cursor measurements are displayed at the top of the display. 4 cursor types are available.

Vertical cursors

For vertical cursors, two results are displayed by default: the absolute value of the time difference between the cursor lines Δt and its inverse value $1/\Delta t$. Optionally, the positions of the cursor lines t_1 and t_2 are also measured. The results are time values and do not depend on any waveform, thus no source is required.



Cursor
Vert. $\Delta t = 600.0 \text{ ns}$ $1/\Delta t = 1.667 \text{ MHz}$

- [CURSor:TDElta?](#) on page 292
- [CURSor:ITDElta?](#) on page 292
- [CURSor:X1Position](#) on page 292
- [CURSor:X2Position](#) on page 292

Horizontal cursors

For horizontal cursors, the vertical values of the cursor positions y_1 and y_2 are measured. These are usually voltage or current values. The absolute value of the difference between the positions Δy is also displayed.

Cursor Horiz.	C1	y1 = -120.0 mV	$\Delta y = 240.0$ mV
		y2 = 120.0 mV	

- [CURSor:Y1Position](#) on page 293
- [CURSor:Y2Position](#) on page 293
- [CURSor:DELTA?](#) on page 292

Track cursors

Two vertical cursor lines are coupled to the waveform. The instrument measures the vertical values y1 and y2 of the crossings between the cursor lines and the waveform. It also measures the absolute values of the difference between the positions Δy and of the time difference between the cursor lines Δt

Cursor Track	C1	y1 = 384.3 mV	$\Delta y = 13.41$ mV
		y2 = 397.7 mV	$\Delta t = 600.0$ ns

- [CURSor:Y1Amplitude?](#) on page 293
- [CURSor:Y2Amplitude?](#) on page 293
- [CURSor:DELTA?](#) on page 292
- [CURSor:TDELTA?](#) on page 292

Measurements

Two vertical cursor lines define a gate for two parallel automatic measurements. All automatic measurements that need only one source are available. Delay, phase, and power measurements are not provided for cursor measurements, they require two sources.

See [Chapter 3.2.3, "Measurement Types"](#), on page 76.

Cursor Meas	C1	T = 99.85 ns	Rise = 27.13 ns
-------------	-----------	--------------	-----------------

If the measurement result is outside the measurement range and clipping occurs, the results are marked with < (underflow) or > (overflow). Adjust the vertical scale to get valid results.

- [CURSor:MEASurement<m>:RESult:ACTual?](#) on page 293
- [CURSor:MEASurement<m>:RESult:LIMit?](#) on page 293

3.3.3 Settings for Cursor Measurements

Access: "Cursor" menu

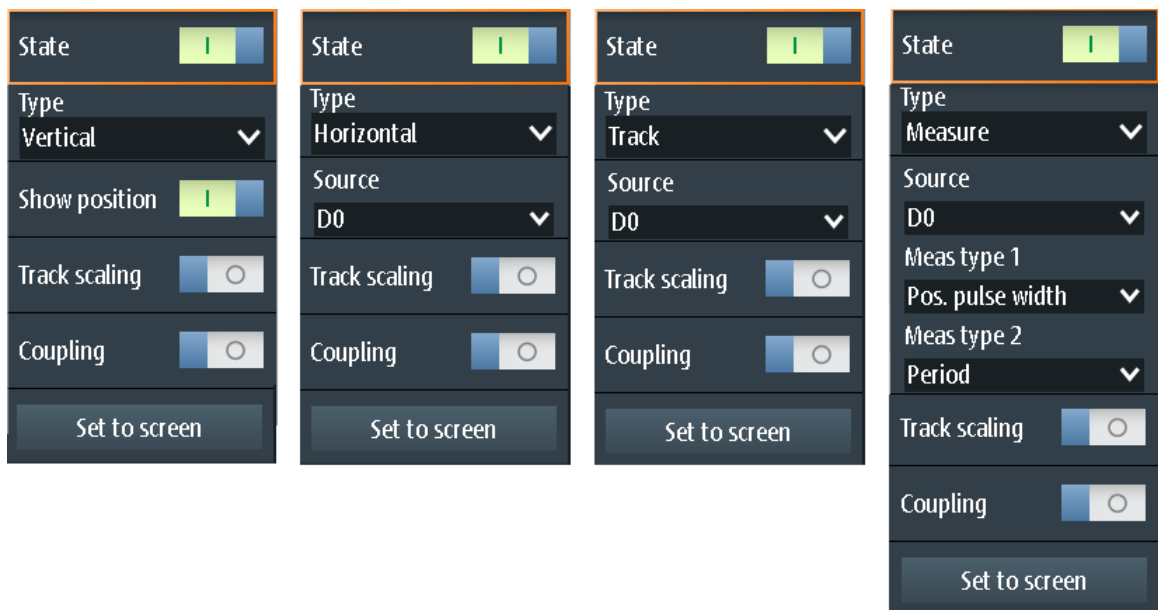
**State**

Enables or disables the cursor measurement.

Remote command:

[CURSor:STATe](#) on page 290

Type

Defines the type of the cursor measurement.

For details, see [Chapter 3.3.2, "Cursor Types and Results"](#), on page 82.

"Vertical"	Displays two vertical cursor lines and measures their timing parameters.
"Horizontal"	Displays two horizontal cursor lines and measures their amplitude parameters.
"Track"	Displays two vertical cursor lines and couples them to the source waveform. The amplitude characteristics and the time difference of the crossing points are measured.
"Measure"	Displays two vertical cursor lines that define a gate for two simultaneous automatic measurements.

Remote command:

[CURSor:FUNction](#) on page 290

Source

Defines the source on which the cursor measurement is performed. The source can be any active analog or digital input signal, math waveform, or bus (requires option).

The source setting is not available for the cursor type "Vertical", and for measurements in the XY-diagram.

Remote command:

[CURSor:SOURce](#) on page 290

Show Position

Shows the position values of the vertical cursor lines t1 and t2 in the measurement results. The setting is only available for the vertical cursor type.

Cursor	t1 = -285.6 ns	Δt = 600.0 ns
Vert.	t2 = 314.4 ns	1/ Δt = 1.667 MHz

Meas Type 1 / Meas Type 2

Set the automatic measurements to be performed on the source waveform between the cursor lines. The setting is only available for the "Measure" cursor type.

All automatic measurements that need only one source are available. Delay, phase, and power measurements are not provided for cursor measurements, they require two sources.

For a description of the measurement types, see [Chapter 3.2.3, "Measurement Types"](#), on page 76.

Remote command:

[CURSor:MEASurement<m>:TYPE](#) on page 291

Track Scaling

If enabled, the position of the cursor lines is adjusted if the vertical or horizontal scales are changed. The cursor lines keep their relative position to the waveform.

If disabled, the cursor lines remain on their position on the display if the scaling is changed.

Remote command:

[CURSor:SCPLing](#) on page 291

Coupling

Couples the cursor lines so that the distance between the two lines remains the same if one cursor is moved.

Remote command:

[CURSor:COUPling](#) on page 291

Set to Screen

Sets the cursors to a default position on the screen. This is helpful if the cursors have disappeared from the display or need to be moved for a larger distance.

Remote command:

[CURSor:SCReen](#) on page 291

3.4 Mathematics

A math waveform is a calculated waveform. You can calculate data out of one or two different sources using several predefined operations.

- ▶ To configure the math waveform, press and hold the MATH key until the menu opens.

- ▶ To activate or deactivate the last configured math waveform, shortly press the MATH key.
- ▶ To adjust vertical scale and position of the math waveform, use the RANGE and POS keys.

You can analyze math waveforms in the same way as channel waveforms: use zoom, perform automatic and cursor measurements, save as reference waveform, and perform mask tests.

Description of settings

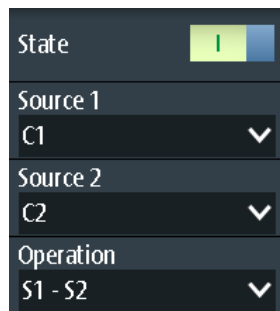

State

Activates the waveform and displays it.

Remote command:

[REFCurve:STATe](#) on page 296

[CALCulate:MATH:STATe](#) on page 294

Source 1 / Source 2

Sets the source(s) for the defined mathematic operation.

Operation

Select an operation to calculate the math waveform.

"S1 + S2"



Addition: Adds the values of "Source 1" and "Source 2".



"S1 - S2"

Subtraction: Subtracts the values of "Source 2" from the values of "Source 1".

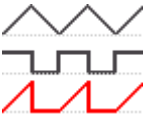
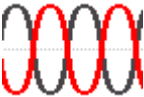
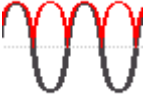

"S1 * S2"	<i>Multiplication:</i> Multiplies the values of "Source 1" and "Source 2". 
"-S1,"	<i>Inverse:</i> Inverts all voltage values of "Source 1", i.e. all values are mirrored at the ground level. Thus, a positive voltage offset becomes negative. 
" S1 "	<i>Abs. Value:</i> Calculates the absolute value of "Source 1". All negative values are inverted to positive values. 
"S1 ² "	<i>Square:</i> Squares the value of "Source 1". 

Remote command:

[CALCulate:MATH\[:EXPRession\] \[:DEFine\]](#) on page 294

RANGE keys

The vertical RANGE keys set the vertical scale (vertical sensitivity) of the math waveform.

Remote command:

[CALCulate:MATH:VERTical:SCALE](#) on page 295

[CALCulate:MATH:VERTical:RANGE](#) on page 295

POS keys

Move the math waveform or down in the diagram. The position is a graphical setting given in divisions.

You can also drag the waveform marker on the screen.

Remote command:

[CALCulate:MATH:VERTical:POSition](#) on page 295

3.5 Reference Waveforms

To compare waveforms and analyze differences between waveforms, you can use a reference waveform. You can also save reference waveforms and load them for further use. The display of a reference waveform is independent from that of the source waveform; you can change the vertical scale and position



To create and save a reference waveform

1. Set up the waveform that will be the reference.
2. Open the "Ref" menu.
3. Select the "Source" waveform.
4. Select "Update".
The reference waveform is created, activated, and shown on top of the original waveform.
5. You can change the vertical scale and position using the RANGE and POS keys.
6. To save the reference, select "Save".
7. Select the "File Type" (format BIN, XML, or CSV).
8. Select the "File Name" and enter the file name.

3.5.1 Settings for Reference Waveforms

Access: "Ref" menu

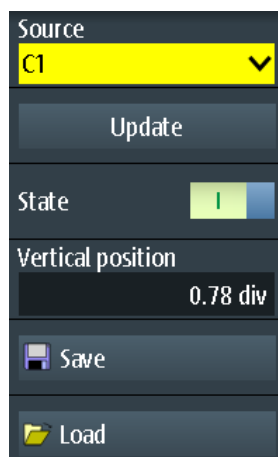

Source

Selects the waveform to be taken as reference waveform. Any active channel or math waveform can be used.

Remote command:

[REFCurve:SOURce](#) on page 295

Update

Creates the reference waveform from the source waveform.

Remote command:

[REFCurve:UPDate](#) on page 295

State

Activates the waveform and displays it.

Remote command:

`REFCurve:STATe` on page 296

`CALCulate:MATH:STATe` on page 294

Vertical Position

Sets the vertical position of the reference waveform.

You can also tap the waveform label "R" to set the focus to the reference waveform, and use the RANGE and POS keys to adjust the display.

Remote command:

`REFCurve:POSition` on page 296

Save/ Load

Saves or loads a reference waveform. The default directory is `C:/Users/<user>/Rohde-Schwarz/RTH/ReferenceCurves`.

Select the "File Type" (format BIN, XML, or CSV) and enter the "File Name". See also [Chapter 3.5.2, "Waveform Files"](#), on page 89.

Remote command:

`REFCurve:NAME` on page 296

`REFCurve:SAVE` on page 296

`REFCurve:OPEN` on page 296

`REFCurve:DELeTe` on page 296

3.5.2 Waveform Files

Reference waveforms can be stored in XML, CSV, or BIN format.



If you want to reload reference waveforms on the instrument, save them in BIN or CSV format. XML files cannot be reloaded.

Waveform data is saved in two files. One file contains the waveform data values and is indicated by `*Wfm.*` in the file name. The second file contains the header data, for example, time scale, vertical scale, vertical position, acquisition mode, and more. Header data is required to reload the waveform from data, or to analyze the data values of the data file.

3.5.2.1 Waveform Header Files

The header files of XML and BIN waveform files are written in XML format. The header files of CSV waveform files are written in CSV format. You can open the header files and use their information for data analysis.

CSV header files only contain the property names and values, one property per row.

```
VerticalScale:0.05:
```

```
HorizontalScale:5e-08:
```

XML header files contain more information than CSV header files. For analysis, only Name and Value are needed.

```
<Prop Name="VerticalScale" Value="0.05" UserValue="0.05" Step="0.001" Default="0.05"
Min="0.001" Max="100" StepDefault="0.001" StepFactor="10" UnitId="77"
UnitName="V/div" BitGroupSize="0" Format="0"></Prop>
<Prop Name="HorizontalScale" Value="1e-07" UserValue="1e-07" Step="1e-09"
Default="1e-07" Min="1e-09" Max="500" StepDefault="1e-09" StepFactor="10"
UnitId="75" UnitName="s/div" BitGroupSize="0" Format="0"></Prop>
```

Header files contain the following properties:

Value	Description
Vertical settings	
VerticalScale	Vertical scale of the waveform in Volts per division, or other unit / division
VerticalOffset	Vertical offset of the waveform in Volts, or other unit
VerticalPosition	Vertical position of the waveform in divisions
Horizontal and acquisition settings	
HorizontalScale	Time scale in seconds per division
HorizontalLeft	Horizontal start value of the waveform (time in s)
HorizontalResolutionPP	Time between two recorded samples
HorizontalAcquisitionMode	Sample, Peak Detect, High Res, Envelope, or Average
HorizontalDecimationFactor	At long time bases, if the number of captured samples is higher than the available record length, decimation takes effect. If the time scale is $\leq 5 \mu\text{s}/\text{div}$, the decimation factor is 1.
Samples	
HorizontalTraceLength	Record length, number of recorded waveform samples, which are stored in the memory
PostSettlingSamples	Number of additional samples after the end of the waveform record.
PreSettlingSamples	Number of additional samples before the beginning of waveform samples. They ensure that all measurements can be performed on the reloaded waveform that could be performed on the original waveform.

3.5.2.2 Waveform Data Files

The waveform data files are indicated by **Wfm.** in the file name. They contain the actual waveform data, the Y-values of the samples. Mostly, the Y-values are voltages: Y0; Y1; Y2; Y3; ...

Before and after the waveform data, the instrument writes some presettling and post-settling samples. The overall number of values in the data file is:

$$\text{ValuesNumber} = \text{PreSettlingSamples} + \text{HorizontalTraceLength} + \text{PostSettlingSamples}$$

For envelope waveforms, the number of values in the file doubles. Two Y-values for each sample are written, one for the upper and one for the lower envelope:

Ymin0; Ymax0; Ymin1; Ymax1; Ymin2; Ymax2; Ymin3; Ymax3;...

In peak detect acquisition mode, the number of values depends on the decimation factor. If the decimation factor is 1, one value per sample is written. At higher decimation factors, two values per sample are written.

In CSV files, the data values of one sample are written in one row. Envelope data, for example, looks like this:

```
-0.0125490196078431    -0.0619607843137255
-0.0133333333333333    -0.0627450980392157
-0.0149019607843137    -0.0650980392156863
```

XML files are easy to read:

```
<sample>
  <datamax>-0.012549</datamax>
  <datamin>-0.0619608</datamin>
</sample>
<sample>
  <datamax>-0.0133333</datamax>
  <datamin>-0.0627451</datamin>
</sample>
<sample>
  <datamax>-0.014902</datamax>
  <datamin>-0.065098</datamin>
</sample>
```

3.6 XY-Diagram

XY-diagrams combine the voltage or current levels of two input signals in one diagram. They use the level of a second signal as the x-axis, rather than a time base. This allows you to perform phase shift measurements, for example.



1. Press the MODE key.
2. Select "XY".
3. Make sure that the signals, the trigger, and the acquisition are set up correctly. The following menus are available in XY-mode:
 - "Vertical", see [Chapter 2.2, "Vertical Setup"](#), on page 38.
 - "Horizontal", see [Chapter 2.3, "Horizontal Setup"](#), on page 42.
 - "Trigger", see [Chapter 2.5, "Trigger"](#), on page 46.
 - "Acquire", see [Chapter 2.4, "Acquisition Control"](#), on page 43.

To analyze the signal in XY-mode, you can use cursor measurements. You can select vertical or horizontal cursors, couple the cursor lines or set them to screen. All other cursor settings are not relevant for measuring the XY-diagram.

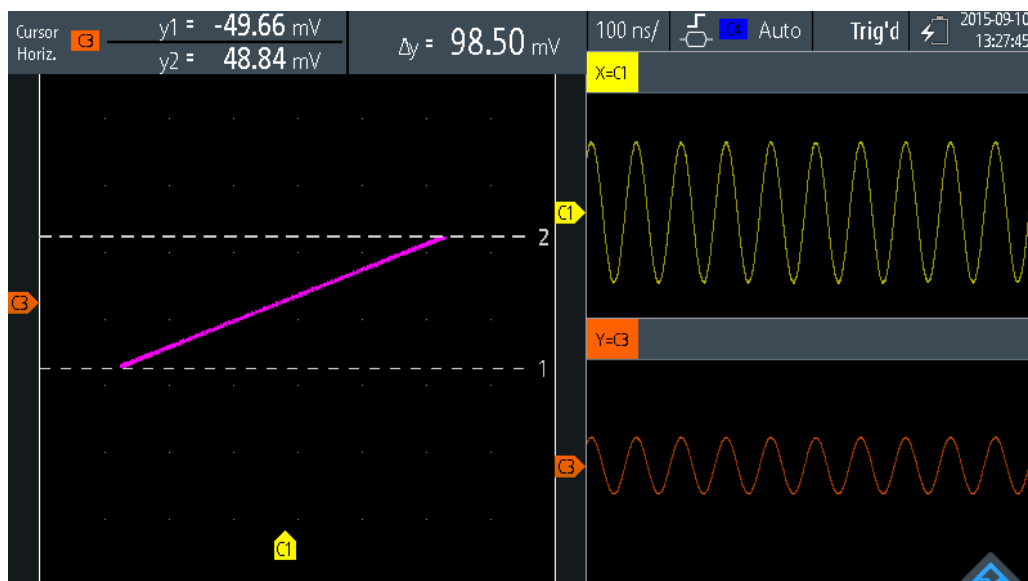

Description of settings

Source X

Defines the signal that supplies the x-values of the XY-diagram, replacing the usual time base. The source can be any of the active analog channels.

Source Y

Defines the signal to be displayed in y-direction in an XY-diagram. The source can be any of the active analog channels.

3.7 History (Option R&S RTH-K15)

The history option R&S RTH-K15 accesses the data of previous acquisitions and provides them for further analysis. Using this option, you can analyze, for example, packet communication on serial buses, radar pulses, laser pulses, and signals that occur in short bursts with long idle times.

If history is enabled and an acquisition runs, the instrument stores the captured waveforms, processes the data and displays the current waveform. Each stored waveform is called a segment. When the acquisition is stopped, the history player is shown to access the stored segments, and to display and analyze them. When you start a new acquisition, the history is cleared and written anew.

The history stores the following data during acquisition:

- All active analog channels.
- All logic channels if at least one logic is active (with option R&S RTH-B1).
- Decoded bus data if the bus is active (with option R&S RTH-K1 and/or R&S RTH-K2).

To enable the history:

1. Tap the Menu button and select "History" on the menu.
2. Enable "History".

3.7.1 History Settings

Access: "History" menu

**History**

Enables the history function. The instrument stores the captured waveforms in segments. After stopping the acquisition, you can analyze them.

Remote command:

[CHANnel<m>:HISTory\[:STATe\]](#) on page 297

Number of Segments

Sets the number of segments to be stored.

Note: If zoom or mathematics are active during acquisition, the actual number of stored segments may be less than the defined number. To avoid the decrease of stored waveforms, disable zoom and mathematics before you acquire the waveforms. You can enable zoom and mathematics later in stop mode and use them to analyze any of the history segments.

Remote command:

[CHANnel<m>:HISTory:NSEGments](#) on page 297

Player Speed

Defines how fast the history player shows the stored segments.

Remote command:

[CHANnel<m>:HISTory:TPACq](#) on page 297

Player Control Position

Sets the position of the history player window on the display. You can drag the window on the touchscreen to another position. If so, a "User" position is indicated.

Available Acquisition

Shows the number of segments that are currently stored in the history.

Remote command:

[ACQUIRE:AVailable?](#) on page 298

Start Acquisition / Stop Acquisition

Define the index of the first and the last history segment that the history player shows. Change these values if you want to see a smaller range of subsequent segments from the history. The newest segment has always the index "0". Older segments have a negative index. The number of available segments is shown in "Available Acquisition".

Remote command:

[CHANnel<m>:HISTory:START](#) on page 298

[CHANnel<m>:HISTory:STOP](#) on page 298

Time Format

Defines if the timestamp in the history player window shows the absolute or relative time. Absolute time is the date and the daytime of the current acquisition. Relative time is the difference to the newest segment (index = 0).

See also "[Timestamp](#)" on page 95.

3.7.2 Displaying History Data

In the history player window, you start and stop the playback of the stored segments, and you can display a particular acquisition.

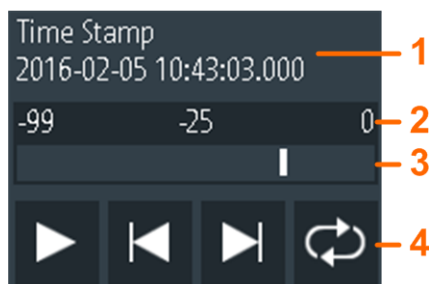

1 = Timestamp, here: absolute time

2 = Index of the oldest, current, and newest (= 0) segment

3 = Slider to set the displayed segment

4 = Control buttons: Play, Step Forward, Step Back, and Repeat

Timestamp

The timestamp shows the time of the currently displayed history segment. Thus, the time relation between acquisitions is always available. More precisely, the timestamp is the time of the trigger event.

The timestamp can be absolute or relative:

- Absolute: Date and daytime of the trigger event of the displayed segment. Depending on the horizontal position, the waveform can be captured up to 100,000 seconds after the trigger event, and thus after the displayed timestamp. The instrument considers this delay automatically, all measurements are related to the trigger event.
- Relative: time difference of the current segment to the newest segment (index = 0).

Remote command:

- `CHANnel<m>:HISTory:TSABsolute?` on page 299
- `CHANnel<m>:HISTory:TSDate?` on page 299
- `CHANnel<m>:HISTory:TSRelative?` on page 300

To display history segments

You can access the history segments in several ways:

- Play back all captured history segments.
- Play back a specified range of subsequent segments.
- Show one particular segment.

Proceed as follows:

1. If the acquisition is running, stop the acquisition.
The history player is shown.
2. To play back the segments once, tap the Play button.
By default, all captured waveforms are shown.
3. To display a range of segments out of the history:
 - a) Open the "History" menu.
 - b) Set the index of the first and the last segment that you want to see.
See "[Start Acquisition / Stop Acquisition](#)" on page 94.
 - c) In the history player window, tap the Play button.
4. To play back the segments repeatedly.
 - a) Enable the "Repeat" button.
 - b) Tap the "Play" button.
5. To access a particular segment, you can:
 - Drag the slider in the history player window, until the required index number is shown.
 - Use the "Step Forward" and "Step Back" buttons to show the next segment.

Remote command:

- `CHANnel<m>:HISTory:PLAY` on page 299
- `CHANnel<m>:HISTory:REPLay` on page 299
- `CHANnel<m>:HISTory:CURRent` on page 298

3.7.3 Analyzing History Data

You can analyze the stored segments using the following possibilities:

- Switch analog channels on and off if they were active during acquisition.
- Change vertical scale and position of captured channels.
- Use the zoom.
- Save screenshots.
- Perform cursor measurements.
- Perform automatic measurements.
- Use the mathematical functions.
- Switch logic channels on and off if at least one channel was active during acquisition.
- Enable and disable the serial bus if it was active during acquisition.

3.7.4 Exporting History Data

You can export history data to files. History data is always saved in "Compressed CSV" files. Each segment is saved to a separate file, and all segment files are written to a compressed folder.

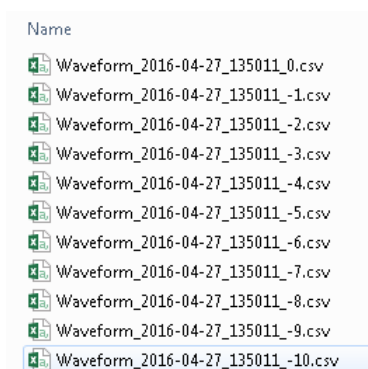

Figure 3-5: Content of a history waveform folder

The file names are built using the filename pattern and the segment index:

`<filename base>_<date>_<time>_<index>.csv.`

In the header section, the relative timestamp of each segment is written. The newest segment with index 0 has the timestamp 0. All timestamps are relative to the newest segment, in s.

Timestamp	-0.000046568
Waveform Type	ANALOG
Acquisition Mode	SAMPLE
Horizontal Unit	s
Horizontal Scale	1.00E-07
Horizontal Position	1.06E-22
Reference Point	50%
Sample Interval	2.00E-10
Record Length	5000
Probe Setting	'10:1'
Vertical Unit	V
Vertical Scale	0.5
Vertical Position	0
Vertical Offset	0

To save history data:

1. Set up the history and capture the waveforms.
2. Press the FILE key.
3. Select "Waveforms".
4. Tap "Select Waveform" and select one waveform for export, or select all active waveforms.
5. Enable "Save History".
If acquisition is running, enabling "Save History" stops the acquisition.
6. Check the "Waveform Directory", the "Filename Base", and the "CSV Column Delimiter". Adjust if necessary.
7. If you need time information for analysis, enable "Store with Time".
8. Tap "Save Waveform".

All export settings are described in [Chapter 11.4.2, "Waveform Export Settings"](#), on page 225.

4 Mask Testing

Masks are used to determine whether the amplitude of a signal remains within specified limits, e.g. to detect errors or test compliance of digital signals.

A mask is specified by an upper and a lower limit line. The signal must run inside these limit lines, otherwise a mask violation occurs. A new mask is created from an existing signal: Mask limits are created by copying the waveform, and the limits are moved and stretched. The result is a tolerance tube around the signal that is used as mask.

4.1 Accessing the Mask Mode

1. Press the MODE key.

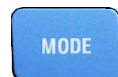

2. Select "Mask".

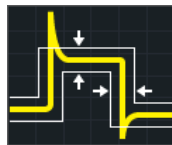

The mask interface is displayed and mask testing is started if masks are already defined and activated.

4.2 Mask Test Results

Mask testing checks all active waveforms for mask violation simultaneously.

The test result of the selected mask is shown in the result table in the upper left corner of the display.

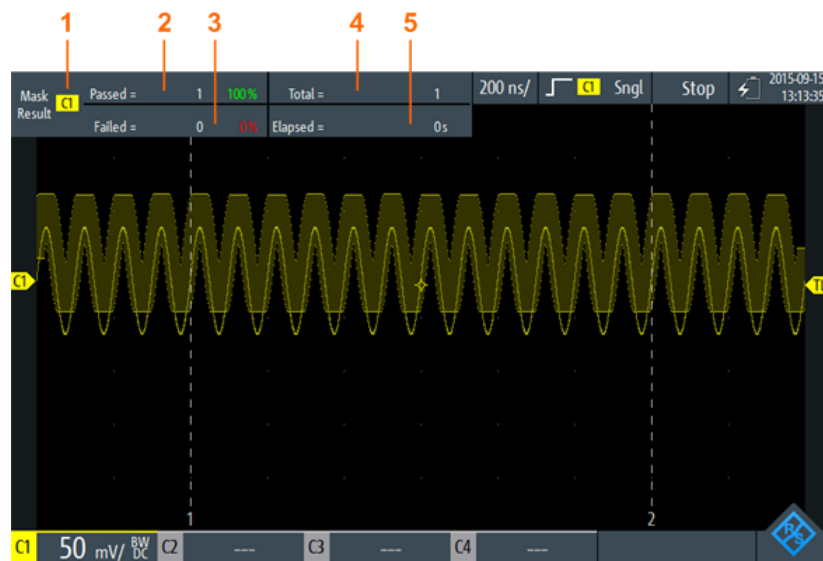

Figure 4-1: Mask-mode-view

- 1 = Selected channel
- 2 = Number and percentage share of passed acquisitions
- 3 = Number and percentage share of failed acquisitions
- 4 = Number of tested acquisitions
- 5 = Test duration

Remote commands for mask test results:

- [MASK:CHANnel<m>:RESult:PASS\[:COUNT\]?](#) on page 303
- [MASK:CHANnel<m>:RESult:PASS:PERCentage?](#) on page 303
- [MASK:CHANnel<m>:RESult:FAIL\[:COUNT\]?](#) on page 302
- [MASK:CHANnel<m>:RESult:FAIL:PERCentage?](#) on page 302
- [MASK:CHANnel<m>:RESult:TOTL\[:COUNT\]?](#) on page 303
- [MASK:ELAPsedtime:TOTAL?](#) on page 303
- [MASK:ELAPsedtime\[:SECS\]?](#) on page 304
- [MASK\[:TESTstate\]?](#) on page 302

4.3 Running Mask Tests

1. Before you can perform mask tests, adjust the waveforms by editing the vertical, horizontal, trigger and acquisition settings.

For details see:

- [Chapter 2.2, "Vertical Setup"](#), on page 38
- [Chapter 2.3, "Horizontal Setup"](#), on page 42
- [Chapter 2.5, "Trigger"](#), on page 46
- [Chapter 2.4, "Acquisition Control"](#), on page 43

Note: The acquisition mode "Envelope" is not available while running mask tests.

2. If you want to test a mathematical (math) waveform, generate a math waveform, see [Chapter 3.4, "Mathematics"](#), on page 85.
3. Select the "Mask" menu.
4. Select the mask channel that is assigned to the tested waveform.
5. To activate the mask, tap "State".

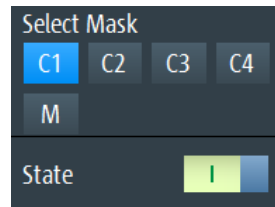

Note: If the selected mask was used before, the stored mask is displayed.

6. To set the mask width, enter "Width X" and "Width Y".
7. Select the "Action on Violation".
This action is applied to all masks.
8. To create the mask, tap "Create Mask".
9. To start and stop mask testing, press the RUN STOP key.



Analyzing the mask test

To view the details of the waveform at a mask test violation, you can use the zoom function, see [Chapter 3.1, "Zoom"](#), on page 73. Zooming is only possible while the mask test is stopped.

4.4 Mask Settings

Access: "Mask" menu

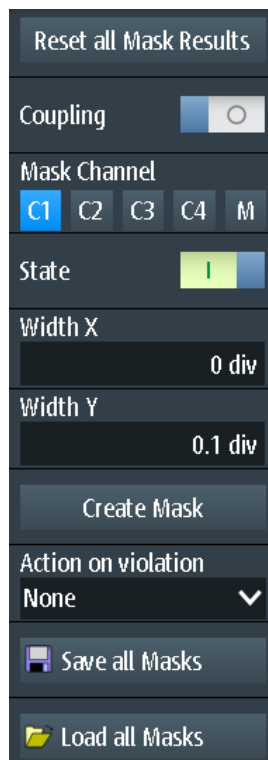

Figure 4-2: Mask settings

Reset all Mask Results

Resets all mask test results.

Remote command:

[MASK:RST](#) on page 302

Coupling

If enabled, the settings of the selected mask are applied to all active masks when you tap "Create Mask".

Mask Channel

Selects the mask to be configured.

If the selected mask has been created before, and it is active, the mask is shown on the display.

Each mask channel is assigned to its related waveform (input channel or math waveform) as indicated by the mask channel name.

State

Turns the mask on or off.

If the assigned waveform is inactive, it is activated together with the mask.

Remote command:

[MASK:CHANnel<m>:STATe](#) on page 300

Width X

Changes the width of the mask in horizontal direction.

The specified number of divisions is added to the positive x-values and subtracted from the negative x-values of the mask limits in relation to the mask center. Thus, the left half of the mask is pulled to the left, the right half is pulled to the right.

To apply the changed value to an existing mask, tap "Create Mask".

Remote command:

[MASK:CHANnel<m>:PROPerties:XWIDth](#) on page 300

Width Y

Changes the width of the mask in vertical direction.

The specified number of divisions is added to the y-values of the upper mask limit and subtracted from the y-values of the lower mask limit. Thus, the upper half of the mask is pulled upwards, the lower half is pulled down, and the overall height of the mask is twice the "Width Y".

To apply the changed value to an existing mask, tap "Create Mask".

Remote command:

[MASK:CHANnel<m>:PROPerties:YWIDth](#) on page 301

Create Mask

Creates a new mask, or applies modified mask settings to the mask.

If "Coupling" is enabled, all active masks are recreated with the settings of the selected mask.

Remote command:

[MASK:CHANnel<m>:CREatemask](#) on page 301

Action on Violation

Selects the action to be executed if the mask limits are violated.

This action is applied to all masks.

Remote command:

[MASK:ONViolation\[:SELECTION\]](#) on page 301

Save all Masks

Opens an explorer to save all active masks.

Load all Masks

Opens an explorer to load masks.

If an acquisition is running, the acquisition is topped until the masks are reloaded.

RUN / STOP

Starts and stops triggering on mask violations.

Remote command:

[RUN](#) on page 258

[STOP](#) on page 259

5 Spectrum Analysis

The R&S RTH provides several forms of spectrum analysis:

- Basic FFT calculation, which is included in the firmware
 - Spectrum analysis option R&S RTH-K18, which is hardware-supported and provides a wide range of analysis possibilities, for example,
 - Harmonics measurement option R&S RTH-K34, which provides an overview and characteristic details on the harmonics contained in the measured signal
- | | |
|--|-----|
| • FFT Mode | 103 |
| • Spectrum Mode (Option R&S RTH-K18) | 108 |
| • Harmonics Measurement (Option R&S RTH-K34) | 125 |

5.1 FFT Mode

The new FFT mode is included in the standard R&S RTH installation and allows you to perform FFT analysis directly on the instrument. During FFT analysis, the captured signal in the time domain is converted to a spectrum of frequencies. As a result, the magnitude of the determined frequencies can be displayed.

5.1.1 Accessing the FFT Mode

1. Press the MODE key.

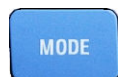

2. Select "FFT".



A power vs. frequency (spectrum) diagram is displayed, and the spectrum of the currently captured data is analyzed, if available.

5.1.2 Display and Control

The FFT display shows a power vs. frequency (spectrum) diagram and relevant analysis parameters. FFT results are useful to obtain an overview of the input signal in the frequency domain and to detect unusual signal effects (such as spurs or distortions) visually.

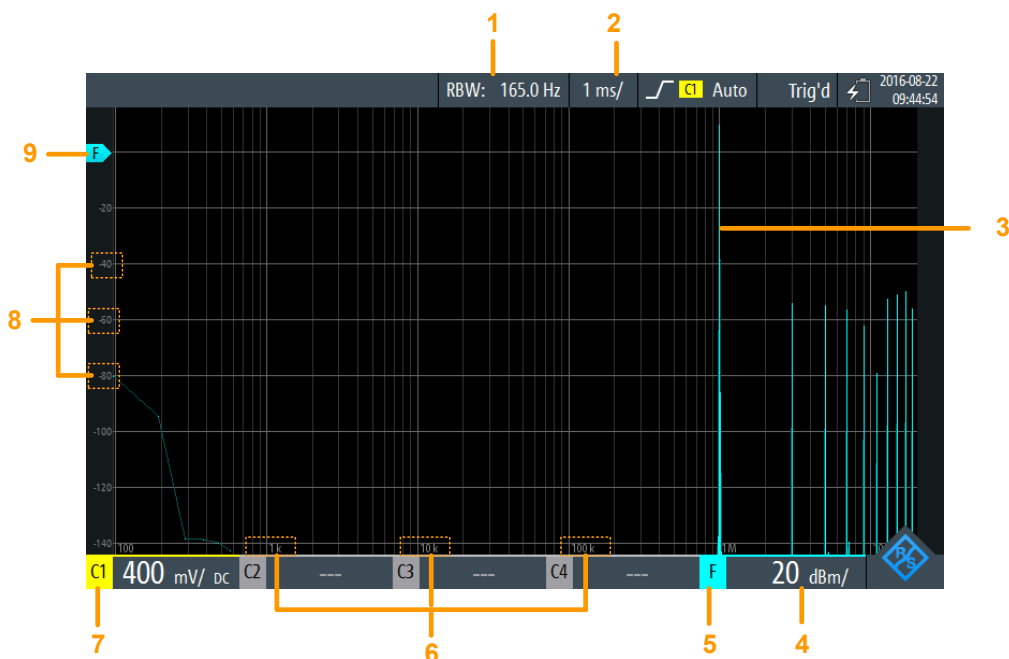

Figure 5-1: FFT display

- 1 = Resolution bandwidth (RBW), determined from channel bandwidth and frequency span
- 2 = Time scale (time per division)
- 3 = Power vs. time waveform
- 4 = Amplitude (y-axis) scale (range per division)
- 5 = FFT mode active
- 6 = Frequency values (x-axis)
- 7 = Channel providing input data
- 8 = Amplitude values (y-axis)
- 9 = 0 dBm line (y-axis)

Data source

FFT analysis is performed on the data captured from one of the active input channels. Analysis can be performed on all channels simultaneously.

Time base

FFT analysis is generally performed on the data captured during the entire data acquisition. To restrict the time base for which FFT analysis is to be performed (thus reducing calculation time), you must change the [Time Scale](#). Gating or zooming is not available for FFT analysis.

Frequency range

The spectrum display can also be restricted to a specified frequency range. By default, the full determined spectrum is displayed. However, you can restrict the channel bandwidth to a smaller value.



Aliasing

In FFT mode, no lowpass filter is applied. If aliasing occurs, try restricting the frequency range of the input signal using the [Channel Bandwidth](#) setting.

Note that, as opposed to FFT mode, the Spectrum mode (option R&S RTH-B18) uses an anti-aliasing filter.

The frequency axis is adjusted to the available spectrum and the selected [X-Scaling](#) mode (linear or logarithmic). For linear scaling, the frequency axis starts at 0 Hz.

For logarithmic scaling, it starts at the frequency resolution (the distance between two individual frequency values on the x-axis), which depends on the selected [Frequency Span](#) and the [Channel Bandwidth](#).



In logarithmic mode, not all possible amplitude values for a specific frequency may occur. Each result is indicated by a bright, colored trace point.

The DC amplitude (at 0 Hz) is not displayed, as $\lg(0)$ is not defined.

The maximum frequency value depends on the following parameters and is adjusted accordingly:

- [Sample Frequency](#) (the sample rate with which FFT analysis is performed)
- [Channel Bandwidth](#)
- Installed bandwidth options

Amplitude range

The amplitudes determined for each frequency are displayed on the y-axis of the spectrum. The values are scaled in dBm (dBmW) based on 50 Ω impedance.

To change the displayed range, use the [RANGE keys](#) and the [POS keys](#). The position of the 0 dBm line is indicated by an "F" on the y-axis.



AUTOSET, vertical, and trigger settings

Vertical and trigger settings for the input signal must be applied in Scope mode, before FFT mode is selected. The same applies to automatic adjustment of the instrument settings to the input signal (AUTOSET).

5.1.3 Performing FFT Analysis

1. Before you can perform FFT analysis, adjust the waveforms by editing the vertical, horizontal, trigger and acquisition settings.

For details, see:

- [Chapter 2.2, "Vertical Setup"](#), on page 38
- [Chapter 2.3, "Horizontal Setup"](#), on page 42
- [Chapter 2.5, "Trigger"](#), on page 46

- [Chapter 2.4, "Acquisition Control"](#), on page 43
2. To adjust the instrument settings to the current input signal automatically, press AUTOSET.
 3. Select the "FFT" mode.
 4. Select the "Frequency Span" setting and determine which sample frequency you require ("Max" is the highest).
 5. Select the "Window" type according to the signal characteristics that are most relevant for your measurement task (see ["Window type"](#) on page 107).
 6. Select the "Channel Bandwidth" setting and define the frequency limit of the spectrum diagram. Frequencies above the selected limit are removed to reduce noise at different levels.
 7. To switch to a logarithmic frequency scaling, select "X-Scaling": "Logarithmic".
 8. To start and stop FFT analysis, press the RUN STOP key.



5.1.4 FFT Mode Settings

Access: "FFT" menu



Additional settings for horizontal (time) scaling and data acquisition are available for FFT mode and directly accessible via the FFT menu. For a description, see:

- ["Time Scale"](#) on page 43
- ["Acquisition Mode"](#) on page 44
- ["Sampling Rate C1 - C4"](#) on page 45

Furthermore, the history function can be used to perform FFT analysis on stored data, see [Chapter 3.7, "History \(Option R&S RTH-K15\)"](#), on page 92.

CH <N>	106
Frequency Span	107
Window type	107
Channel Bandwidth	108
X-Scaling	108
Sample Frequency	108



CH <N>

Selects the channel for which the captured data is analyzed in FFT mode. FFT analysis can be performed on all channels simultaneously.

Remote command:

[SPECTrum: SOURce](#) on page 304

Frequency Span

Determines how many values are analyzed by a single FFT (sample frequency), and thus the frequency resolution. The larger the value, the higher the resolution, but the longer the required analysis time.

Note: Due to the longer analysis time, changes to the measurement settings may only become visible with a time delay.

Furthermore, the frequency span determines the visible range in the spectrum diagram. Depending on the selected frequency span, the time scale may be restricted (see "Time Scale" on page 43).

"Narrow" 8k values analyzed per FFT; time scale ≥ 100 ms/div

"Max" 64k values analyzed per FFT; time scale ≥ 1 µs/div

Remote command:

[SPECTrum:FREQUency:SPAN:MODE](#) on page 306

[SPECTrum:FREQUency:SPAN\[:VALue\]](#) on page 306

[SPECTrum:FREQUency:CENTer](#) on page 305

[SPECTrum:FREQUency:STARt](#) on page 306

[SPECTrum:FREQUency:STOP](#) on page 307

[SPECTrum:FREQUency:BANDwidth\[:RESolution\]\[:VALue\]](#) on page 305

Window type

Windowing helps minimize the discontinuities at the end of the measured signal interval and thus reduces the effect of spectral leakage, increasing the frequency resolution.

Various different window functions are provided in the R&S RTH to suit different input signals. Each of the window functions has specific characteristics, including some advantages and some trade-offs. Consider these characteristics carefully to find the optimum solution for the measurement task.

Table 5-1: Window type characteristics

Window type	Frequency resolution	Magnitude resolution	Measurement recommendation
Rectangular	Best	Worst	Separation of two tones with almost equal amplitudes and a small frequency distance
Hamming Hann	Good	Poor	Frequency response measurements, sine waves, periodic signals and narrow-band noise
Flat-Top	Poor	Best	Accurate single-tone measurements
Blackman	Worst	Best	Mainly for signals with single frequencies to detect harmonics Accurate single-tone measurements

Remote command:

[SPECTrum:FREQUency:WINDow:TYPE](#) on page 307

[SPECTrum:FREQUency:WINDow:FACTor?](#) on page 307

Channel Bandwidth

Determines the frequency limit of the spectrum. Frequencies above the selected limit are removed to reduce noise at different levels. Values from 1 kHz to 10 MHz can be selected. Alternatively, the full span of the current input signal can be selected.

For more details on the channel bandwidth, see ["Bandwidth"](#) on page 39.

Remote command:

[CHANnel<m>:BANDwidth](#) on page 254

X-Scaling

Defines the scaling method for the frequency (x-)axis of the spectrum display.

"Linear" Linear scaling

"Logarithmic" Logarithmic scaling

Note that in this mode, not all possible amplitude values for a specific frequency may occur. Each result is indicated by a bright, colored trace point.

The DC amplitude (at 0 Hz) is not displayed, as $\lg(0)$ is not defined.

Remote command:

[SPECTrum:FREQUENCY:HORizontal:SCALE](#) on page 305

Sample Frequency

Indicates the sample rate with which FFT analysis is performed. This value may differ from the [Sampling Rate C1 - C4](#) in the data acquisition settings, as the number of samples must be adjusted to a value of 2^x FFT points.

Remote command:

[SPECTrum:FREQUENCY:SAMPLE?](#) on page 306

5.2 Spectrum Mode (Option R&S RTH-K18)

The optional Spectrum mode allows you to perform sophisticated spectrum analysis directly on the instrument. During spectrum analysis, the captured signal in the time domain is converted to a spectrum of frequencies. As a result, various signal characteristics in the frequency domain can be displayed.

- [Accessing the Spectrum Mode](#)..... 109
- [Display and Control](#)..... 109
- [Performing Spectrum Analysis](#)..... 111
- [Spectrum Mode Settings](#)..... 112
- [Vertical Settings](#)..... 116
- [Marker \(Peak Search\) Settings](#)..... 117
- [Cursor Measurements on Spectrums](#)..... 120
- [Spectrum File Functions](#)..... 123
- [Spectrum Results Export File Format](#)..... 124

5.2.1 Accessing the Spectrum Mode

1. Press the MODE key.

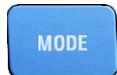

2. Select "Spectrum".

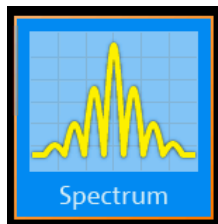

A power vs frequency (spectrum) diagram is displayed, and the spectrum of the currently captured data is analyzed, if available.

5.2.2 Display and Control

The Spectrum display shows a power vs frequency (spectrum) diagram and relevant analysis parameters. Spectrum results are useful to obtain an overview of the input signal in the frequency domain and to detect unusual signal effects (such as spurs or distortions) visually.

The power levels in the diagram are always scaled logarithmically. The frequency axis can be displayed either logarithmically or linearly.

Various statistical evaluations can be performed and displayed simultaneously. In this case, the different traces are displayed in different colors:

- Currently calculated spectrum: cyan-colored trace (like basic FFT)
- Min hold and max hold evaluation: blue trace
- Averaged spectrum: magenta-colored trace

Optionally, markers can be activated to indicate peak values in the spectrum. Track cursors are available to determine the power or power density in a specific frequency range.

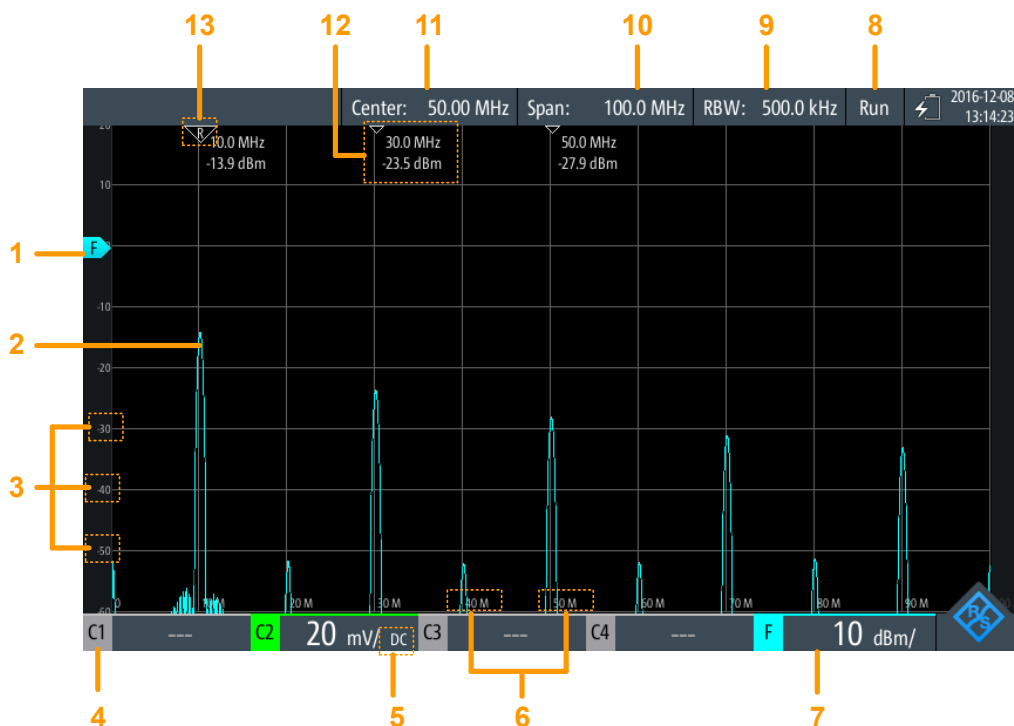

Figure 5-2: Spectrum display

- 1 = Reference level (y-axis, by default 0 dBm line)
- 2 = Currently calculated spectrum (power vs. frequency graph)
- 3 = Amplitude scale (y-axis)
- 4 = Channel providing input data
- 5 = Coupling of the input channel
- 6 = Frequency scale (x-axis)
- 7 = Amplitude scale (y-axis, power per division)
- 8 = Operating status of the spectrum measurement ("Hold"/"Run")
- 9 = Displayed resolution bandwidth
- 10 = Displayed frequency span
- 11 = Center frequency
- 12 = Marker results
- 13 = Reference marker

Data source

Spectrum analysis is performed on the data captured from one of the active input channels. Analysis can only be performed on one channel at a time.

Time base and resolution bandwidth

Spectrum analysis is generally performed on the data captured during the entire data acquisition. To restrict the time base for which spectrum analysis is to be performed (thus reducing calculation time), you must increase the resolution bandwidth (RBW, see "[Resolution bandwidth \(RBW\)](#)" on page 114). Gating or zooming is not available for spectrum analysis.

Frequency range

The spectrum display can also be restricted to a specified frequency range.

The frequency axis is adjusted to the available spectrum and the selected [X-Scaling](#) mode (linear or logarithmic). Note that changing the frequency range only affects the spectrum display, not the calculated results.



In logarithmic mode, not all possible amplitude values for a specific frequency may occur. Each result is indicated by a bright, colored trace point.

The DC amplitude (at 0 Hz) is not displayed, as $\lg(0)$ is not defined.

Amplitude range

The amplitudes determined for each frequency are displayed on the y-axis of the spectrum. The values are scaled in dBm (dBmW) based on 50 Ω impedance.

To change the displayed range, use the [RANGE keys](#) and the [POS keys](#). The position of the 0 dBm line is indicated by an "F" on the y-axis.

Triggering

During spectrum analysis, no triggering is used - the trigger settings are ignored. A spectrum is calculated from the input data continuously.

5.2.3 Performing Spectrum Analysis

1. Before you perform spectrum analysis, adjust the instrument settings to the input signal by editing the vertical, horizontal, and acquisition settings.

For details, see:

- [Chapter 2.2, "Vertical Setup"](#), on page 38
- [Chapter 2.3, "Horizontal Setup"](#), on page 42
- [Chapter 2.4, "Acquisition Control"](#), on page 43

2. To adjust the instrument settings to the current input signal automatically, press AUTOSET.
3. Select the "Spectrum" mode.
4. Define the "Center Frequency" for analysis.
5. Define the "Span" of the spectrum to be analyzed.
6. Define the required "RBW: Span Ratio" according to your test requirements.
7. Select the "Window" type according to the signal characteristics that are most relevant for your measurement task (see ["Window type"](#) on page 107).
8. To switch to a logarithmic frequency scaling, select "X-Scaling": "Logarithmic".

9. To perform statistical evaluation of the spectrum results, select one of the evaluation modes.

For averaging, define the number of values to be considered.

10. Select the "Vertical" menu.

11. Define the unit in which the magnitude values are indicated.

12. Define the "Reference Level" as the highest expected input level.

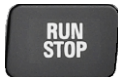

13. To start and stop spectrum analysis, press the RUN STOP key.

14. To determine peaks in the spectrum:

- a) Select the "Marker" menu.
- b) Set the "State" to "On" to enable a peak search.
- c) Define the number of markers as the maximum number of peaks to be detected.
- d) Define the "Threshold", "Excursion", and "Distance" to configure the peak search.
- e) Select one of the displayed traces to be used as the source of the peak search.
- f) Select whether the marker values are indicated as absolute values or relative to the reference (highest) peak.

15. To determine the frequency or level values, or both, at specific points in the spectrum, enable the spectrum track cursors:

- a) Select the "Cursor" menu.
- b) Set the "State" to "On" to display the cursors.
- c) Select one of the displayed traces to be used as the source of the track cursors.
- d) Select whether the values are indicated as absolute values or as the difference between the two cursors ("Delta").
- e) Drag the cursors to the required positions in the spectrum.
The levels and frequencies of the cursors at the crossings with the spectrum are indicated at the top of the diagram.
- f) To keep the cursors at a fixed distance to one another, enable the "Coupling" option.
- g) To keep the cursors at a fixed (relative) distance to the spectrum, regardless of the current scaling, enable the "Track Scaling" option.

5.2.4 Spectrum Mode Settings

Access: "Spectrum" menu



Additional settings for horizontal (frequency) scaling and data acquisition are available for Spectrum mode and directly accessible via the "Spectrum" menu. For a description, see:

- "Time Scale" on page 43
- "Acquisition Mode" on page 44
- "Sampling Rate C1 - C4" on page 45

X-Scaling.....	113
Center Frequency.....	114
Span.....	114
Start Frequency/ Stop Frequency.....	114
Resolution bandwidth (RBW).....	114
Window type.....	115
Trace mode (Clear/Write/ Max Hold/ Min Hold/Average).....	115
Reset.....	116

X-Scaling

Defines the scaling method for the frequency (x-)axis of the spectrum display.

- "Linear" Linear scaling
- "Logarithmic" Logarithmic scaling
 Note that in this mode, not all possible amplitude values for a specific frequency may occur. Each result is indicated by a bright, colored trace point.
 The DC amplitude (at 0 Hz) is not displayed, as lg(0) is not defined.

Remote command:

`SPECTrum:FREQuency:HORizontal:SCALE` on page 305

Center Frequency

Defines the frequency in the center of the displayed span for linear frequency scaling (see "X-Scaling" on page 108). Usually, the center frequency is set to the highest measured power level in spectrum analysis.

To set the center frequency, you can also use the POS keys.

Remote command:

`SPECTrum:FREQuency:CENTer` on page 305

Span

Determines the measured frequencies and the visible range in the spectrum diagram for linear frequency scaling (see "X-Scaling" on page 108). Depending on the selected span, the time scale may be restricted (see "Time Scale" on page 43).

To set the span, you can also use the TIME keys.

The span must be within the range 1 kHz to 500 MHz.

Note that this range only affects the displayed spectrum, not the calculated results.

Remote command:

`SPECTrum:FREQuency:SPAN[:VALue]` on page 306

Start Frequency/ Stop Frequency

For logarithmic frequency scaling (see "X-Scaling" on page 108), the displayed frequency range is defined by a start and a stop value, rather than a span and center frequency. Note that this range only affects the displayed spectrum, not the calculated results.

Remote command:

`SPECTrum:FREQuency:START` on page 306

`SPECTrum:FREQuency:STOP` on page 307

Resolution bandwidth (RBW)

The resolution bandwidth (RBW) determines the resolution of the spectrum, that is: the minimum distance between two distinguishable peaks. The higher the resolution (the smaller the ratio), the more peaks are detected, but the longer the measurement requires to finish.

In manual operation, the RBW is defined in relation to the selected frequency span and must lie between 1:1000 and 1:10. If you change the span, the RBW is automatically adjusted to the minimum or maximum allowed value, if necessary. (In remote operation, the RBW can also be defined directly, independently of the span).

In Auto mode, the optimal resolution according to the frequency **Span** and selected **Window type** is used. It is indicated for the "RBW" setting.

Remote command:

`SPECTrum:FREQuency:BANDwidth[:RESolution]:AUTO` on page 309

`SPECTrum:FREQuency:BANDwidth[:RESolution]:RATio` on page 309

`SPECTrum:FREQuency:BANDwidth[:RESolution][:VALue]` on page 305

Window type

Windowing helps minimize the discontinuities at the end of the measured signal interval and thus reduces the effect of spectral leakage, increasing the frequency resolution.

Various different window functions are provided in the R&S RTH to suit different input signals. Each of the window functions has specific characteristics, including some advantages and some trade-offs. Consider these characteristics carefully to find the optimum solution for the measurement task.

Table 5-2: Window type characteristics

Window type	Frequency resolution	Magnitude resolution	Measurement recommendation
Rectangular	Best	Worst	Separation of two tones with almost equal amplitudes and a small frequency distance
Hamming Hann	Good	Poor	Frequency response measurements, sine waves, periodic signals and narrow-band noise
Flat-Top	Poor	Best	Accurate single-tone measurements
Blackman	Worst	Best	Mainly for signals with single frequencies to detect harmonics Accurate single-tone measurements

Remote command:

[SPECTrum:FREQUENCY:WINDow:TYPE](#) on page 307

[SPECTrum:FREQUENCY:WINDow:FACTOR?](#) on page 307

Trace mode (Clear/Write/ Max Hold/ Min Hold/Average)

Determines which of the acquired data is displayed. Several traces can be displayed in parallel, but at least one mode must be selected. By default, the "Clear/Write" mode is selected.

As soon as a new mode is selected, statistical evaluation is restarted.

To clear the results for previous measurements used for statistical evaluation, select [Reset](#).

"Clear/Write"	The currently measured value for each frequency is displayed.
"Max Hold"	The maximum value for each frequency over all measurements is displayed. Using the max hold trace mode is a good way to detect intermittent signals or the maximum values of fluctuating signals, for example.
"Min Hold"	The minimum value for each frequency over all measurements is displayed. Using the min hold trace mode is a good way to highlight signals within noise or suppress intermittent signals.
"Average"	The average value for each frequency in the Clear/write trace over the specified "Number of Averages" is calculated. Averaging reduces the effects of noise, but has no effects on sine signals. Using the trace averaging therefore is a good way to detect signals in the vicinity of noise.

Remote command:

`SPECTrum:WAVEform:MAXimum[:ENABLE]` on page 311

`SPECTrum:WAVEform:MINimum[:ENABLE]` on page 311

`SPECTrum:WAVEform:SPECTrum[:ENABLE]` on page 311

`SPECTrum:WAVEform:AVERage[:ENABLE]` on page 310

`SPECTrum:FREQuency:AVERage:COUNT` on page 308

Reset

Clears the results for previous measurements used in statistical evaluation (see [Trace mode \(Clear/Write/ Max Hold/ Min Hold/Average \)](#)).

Remote command:

`SPECTrum:FREQuency:RESet` on page 311

5.2.5 Vertical Settings

You can configure the vertical settings for the input signal in Scope mode. When you select the Spectrum mode, the configuration is maintained. Some additional vertical settings are available in Spectrum mode.

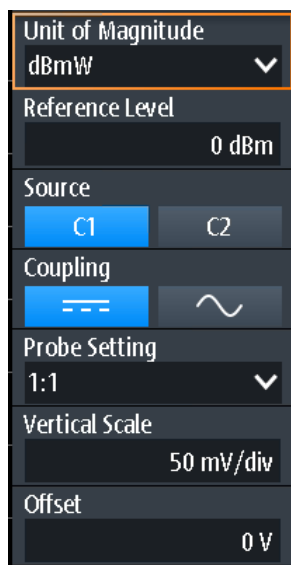

The AUTOSSET function sets the center frequency to the frequency with the highest measured power. All other vertical settings are set to allow for an optimal spectrum display.

The following vertical settings are identical to Scope mode:

- "Coupling" on page 39
- "Probe Setting" on page 39
- "Offset" on page 40

The following settings are available in Spectrum mode only:

Unit of Magnitude..... 117
 Reference Level..... 117
 Source..... 117
 Vertical Scale..... 117

Unit of Magnitude

Defines the unit in which the power values are displayed.

Remote command:

[SPECTrum:FREQUency:MAGNitude:SCALE](#) on page 305

Reference Level

Defines the expected maximum input signal level.

Remote command:

[SPECTrum:FREQUency:MAGNitude:REFerence\[:VALue\]](#) on page 309



Source

Selects the channel for which the captured data is analyzed. Spectrum analysis can only be performed on one channel at a time.

The source can also be selected using the CH1/CH2 keys.

Remote command:

[SPECTrum:SOURce](#) on page 304

Vertical Scale

Defines the scaling of the input signal in Volt per division.

Vertical scale and vertical position affect the resolution of the waveform amplitude directly. To get the full resolution, make sure that the waveforms cover most of the screen's height.

Note: This value configures the input signal. The vertical scale of the y-axis of the spectrum, which is indicated in the channel settings beneath the spectrum diagram, must be configured using the RANGE and POS keys.

5.2.6 Marker (Peak Search) Settings

Access: "Marker" menu



You can configure which peaks the instrument will find within the spectrum results. Peaks are indicated by markers in the power vs frequency display. The frequency and power level measured at the peak is also indicated in the diagram.



Overlapping markers

If two detected peaks are very close to each other and the markers in the display overlap, the marker with the lower amplitude is indicated in a darker color and put slightly in the background, while the one with the higher amplitude is displayed normally. Using the remote commands, both values can be retrieved.

Remote commands for results:

[SPECTrum:MARKer:RESult<m>:FREQuency\[:VALue\]? on page 316](#)

[SPECTrum:MARKer:RESult<m>:FREQuency:DELTA? on page 316](#)

[SPECTrum:MARKer:RESult<m>:LEVel\[:VALue\]? on page 317](#)

[SPECTrum:MARKer:RESult<m>:LEVel:DELTA? on page 317](#)

[SPECTrum:MARKer:RMARker:FREQuency? on page 317](#)

[SPECTrum:MARKer:RMARker:VALue? on page 318](#)

State	119
Number of Markers	119
Threshold	119
Peak excursion	119
Distance	120
Trace Source	120
Marker Value	120

State

If enabled, a peak search is performed on the current spectrum results and the specified **Number of Markers** are displayed.

Remote command:

`SPECTrum:MARKer[:STATe]` on page 314

Number of Markers

Defines the maximum number of markers used to indicate peaks in the spectrum results. With 3 active markers, the 3 peak values in the spectrum are indicated. Note that if fewer peaks are detected than the specified maximum number of markers, fewer markers are displayed.

Remote command:

`SPECTrum:MARKer:COUNT` on page 314

`SPECTrum:MARKer:RCOUNT?` on page 316

Threshold

Defines an absolute level threshold as an additional condition for the peak search. Only peaks that exceed the threshold are detected.

Remote command:

`SPECTrum:MARKer:SETup:MLEVel` on page 315

Peak excursion

Defines a relative threshold, the minimum level value by which the waveform must rise or fall to be considered a peak. To avoid identifying noise peaks, enter a peak excursion value that is higher than the noise levels.

The following figure shows a spectrum display:

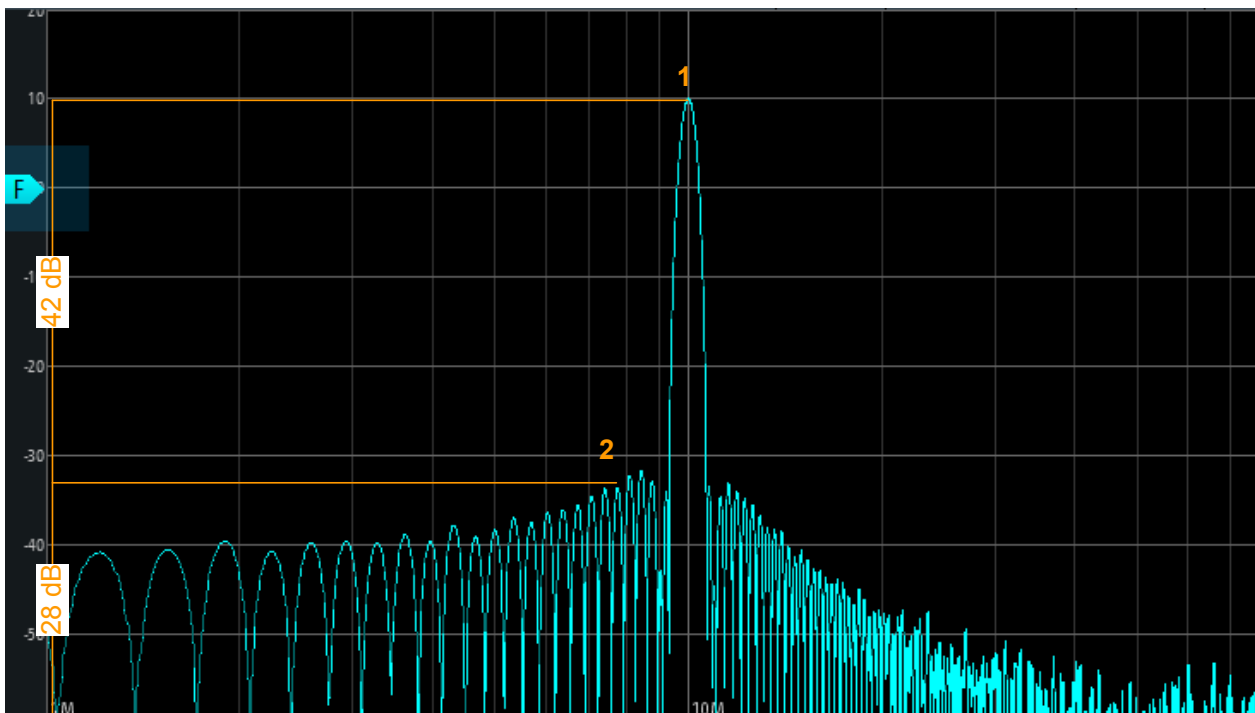

If "Peak excursion" is 30 dB, the peak 1 is found. If "Peak excursion" is 20 dB, also the peak 2 and several others are found.

Remote command:

[SPECTrum:MARKer:SETup:EXCursion](#) on page 315

Distance

Defines a minimum distance between two frequencies that must be exceeded in order to detect individual peaks.

Remote command:

[SPECTrum:MARKer:SETup:DIStance](#) on page 315

Trace Source

Selects the trace on which the markers are placed. Only active traces are available (see "Trace mode (Clear/Write/ Max Hold/ Min Hold/Average)" on page 115).

Remote command:

[SPECTrum:MARKer:SOURce](#) on page 315

Marker Value

Determines whether the absolute measured results at each cursor position are displayed, or the delta between the cursors.

Remote command:

[SPECTrum:MARKer:RESult<m>:FREQuency\[:VALue\]?](#) on page 316

[SPECTrum:MARKer:RESult<m>:FREQuency:DELTA?](#) on page 316

[SPECTrum:MARKer:RESult<m>:LEVel\[:VALue\]?](#) on page 317

[SPECTrum:MARKer:RESult<m>:LEVel:DELTA?](#) on page 317

5.2.7 Cursor Measurements on Spectrums

Track cursors are available for spectrum data to determine the power or power density in a specific frequency range.

5.2.7.1 Cursor Measurement Results

For the spectrum diagram, special track cursors are available. If enabled, you can place the two cursors at any position in the spectrum. As a result, the frequency and measured power levels of the selected trace at the crossing point with the cursors are displayed. Both the power and the power density for each cursor are indicated. Instead of the absolute results for the second cursor, the delta between both cursors can be provided.

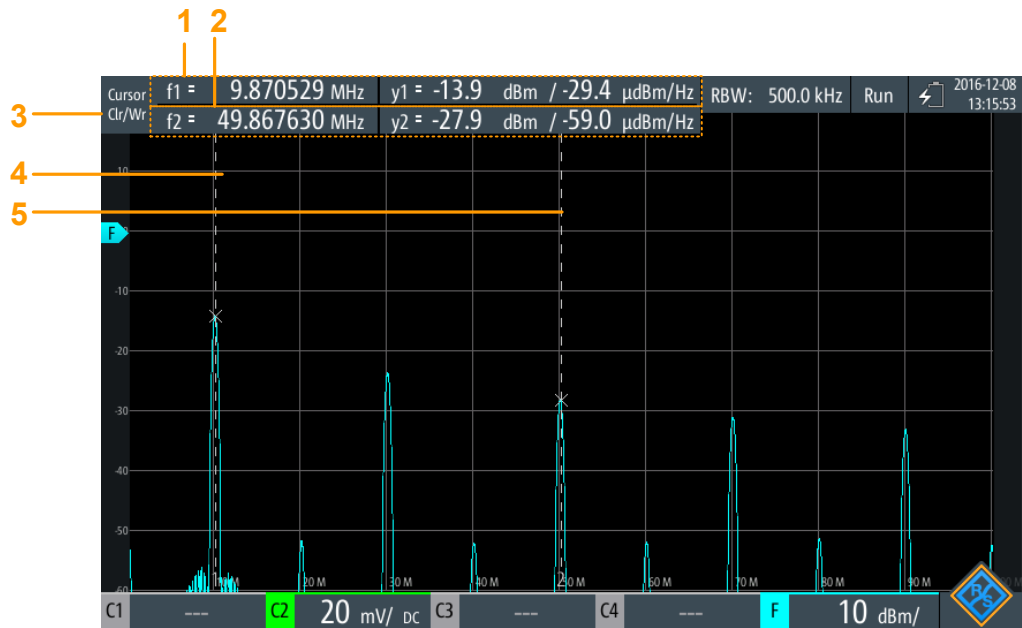

Figure 5-3: Cursor display in Spectrum mode

- 1 = Cursor 1 frequency and level results
- 2 = Cursor 2 frequency and level results
- 3 = Trace used as source for cursor results
- 4 = Cursor 1
- 5 = Cursor 2

Remote commands for results:

[SPECTrum:CURSor<m>:FREQuency\[:VALue\]](#) on page 313

[SPECTrum:CURSor<m>:FREQuency:DELTA?](#) on page 313

[SPECTrum:CURSor<m>:LEVel\[:VALue\]?](#) on page 313

[SPECTrum:CURSor<m>:LEVel:DELTA?](#) on page 313

5.2.7.2 Cursor Settings

Access: "Cursor" menu

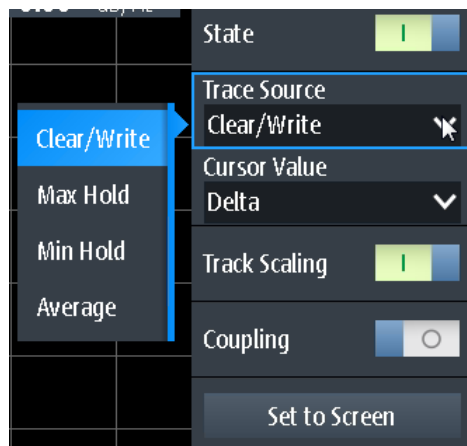
**State**

Enables or disables the spectrum cursor measurement.

Remote command:

[SPECTrum:CURSor<m>:STATe](#) on page 311

Trace Source

Selects the trace on which the cursors are placed. Only active traces are available (see "Trace mode (Clear/Write/ Max Hold/ Min Hold/Average)" on page 115).

Remote command:

[SPECTrum:CURSor<m>:SOURce](#) on page 312

Cursor Value

Determines whether the absolute measured results at each cursor position are displayed, or the delta between the cursors.

Remote command:

[SPECTrum:CURSor<m>:FREQuency\[:VALue\]](#) on page 313

[SPECTrum:CURSor<m>:FREQuency:DELTA?](#) on page 313

[SPECTrum:CURSor<m>:LEVel\[:VALue\]?](#) on page 313

[SPECTrum:CURSor<m>:LEVel:DELTA?](#) on page 313

Track Scaling

If enabled, the position of the cursor lines is adjusted if the vertical or horizontal scales are changed. The cursor lines keep their relative position to the waveform.

If disabled, the cursor lines remain on their position on the display if the scaling is changed.

Remote command:

[SPECTrum:CURSor<m>:SCPLing](#) on page 312

Coupling

Couples the cursor lines so that the distance between the two lines remains the same if one cursor is moved.

Remote command:

[SPECTrum:CURSor<m>:COUPLing](#) on page 312

Set to Screen

Sets the cursors to a default position on the screen. This is helpful if the cursors have disappeared from the display or need to be moved for a larger distance.

Remote command:

[SPECTrum:CURSor<m>:SCReen](#) on page 314

5.2.8 Spectrum File Functions

Access: FILE > "Spectrum"



The results of a spectrum measurement can be exported similarly to a waveform (see also [Chapter 11, "Documenting Results"](#), on page 219). The OneTouch functionality is also available (see [Chapter 11.6, "Quick Save with OneTouch"](#), on page 230).

For details on the export file format, see [Chapter 5.2.9, "Spectrum Results Export File Format"](#), on page 124.

Save, Save As

Save the harmonic results. The functions are available if the instrument is in "Spectrum" mode.

"Save" Saves the file in the defined "Harmonic Directory" using the autonaming pattern.

"Save As" Opens a file explorer where you can select the directory and enter the filename.

Remote command:

[SPECTrum:EXPort:SAVE](#) on page 318

Harmonic Directory

Defines the directory where the harmonic results files are stored. If a USB flash drive is connected, the instrument stores the data to this external device by default.

Remote command:

[SPECTrum:EXPort:NAME](#) on page 318

Filename Base

Defines the first part of the filename. The complete filename pattern is:

<filename base>_<date>_<time>.csv.

Remote command:

[SPECTrum:EXPort:NAME](#) on page 318

Store with Freq.

Includes the frequency values in the stored results.

Remote command:

[SPECTrum:EXPort:INCXvalues](#) on page 318

5.2.9 Spectrum Results Export File Format

The spectrum results export file format is similar to a waveform export file; it is also stored in CSV format. You can convert the comma-separated text to columns (see [Chapter 11.4.3.3, "Converting CSV to Excel Files"](#), on page 229).

Table 5-3: Header data (converted to table)

Spectrum Results	[Example data]
Model	RTH1004
SerialNumber	xxxxx
Firmware Version	'1.50'
Center Frequency [Hz]	2.5e+008
Span [Hz]	5e+008
RBW [Hz]	2.5e+006
Window	Hann
Number of Average [n]	64
Record Length [n]	6554
Start Frequency [Hz]	0
Frequency Resolution [Hz]	76293.9

Table 5-4: Spectrum (trace) data (converted to table data)

Frequency	Clear/Write	Max	Min	Average
[Hz]	[V]/[A] ^{*)}	[V]/[A] ^{*)}	[V]/[A] ^{*)}	[V]/[A] ^{*)}
0	0.000113039			
76293.9	0.000226932			
...				
*) depends on probe setting				



Converting voltage or Ampere to power values

The spectrum results are provided as voltages or in Amperes (depending on the probe setting). To convert these results (U/I) to power values (P), use the following equations:

$$P_{dBV}(U) = 20 \cdot \lg\left(\frac{U}{1V}\right)$$

$$P_{dBA}(I) = 20 \cdot \lg\left(\frac{I}{1A}\right)$$

$$P_{dBm}(U) = 10 \cdot \lg\left(\frac{P}{1mW}\right) = 10 \cdot \lg\left(\frac{U^2}{R} / 1mW\right) = P_{dBV}(U) + 30 - 10 \cdot \lg\left(\frac{R}{1\Omega}\right)$$

$$P_{dBm}(I) = 10 \cdot \lg\left(\frac{P}{1mW}\right) = 10 \cdot \lg\left(\frac{I^2 \cdot R}{1mW}\right) = P_{dBA}(I) + 30 + 10 \cdot \lg\left(\frac{R}{1\Omega}\right)$$

Where:

- R = 50 Ω
- P = U * I = U² / R = I² * R

5.3 Harmonics Measurement (Option R&S RTH-K34)

With this measurement, you can easily measure the harmonics of an input signal. In addition, the total harmonic distortion (THD) is calculated.

The harmonics measurement performs an FFT on the input signal and determines the power levels measured at the specified fundamental frequency and at each harmonic. Harmonics are frequencies that are a multiple of the fundamental frequency.

As a result, the magnitude, frequency and phase values for the selected harmonics are shown, as well as the RMS power values and the total harmonic distortion (THD).

In general, every signal contains harmonics. Harmonics are generated by nonlinear characteristics, which add frequencies to a pure sine wave. Harmonics are particularly critical regarding high-power transmitters such as transceivers because large harmonics can interfere with other radio services.

Harmonic distortion can be determined as the level of the individual components, or as the root mean square of all components together, the total harmonic distortion (THD). The THD is set in relation to the power of the fundamental frequency.

5.3.1 Accessing the Harmonic Mode

1. Press the MODE key.



2. Select "Harmonic".

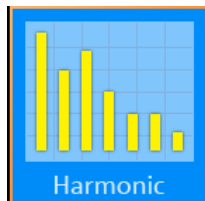

An FFT is performed on the input signal, and the power level at the fundamental and all harmonic frequencies of the signal (that is: all multiples of the fundamental frequency) are analyzed.

5.3.2 Harmonic Measurement Results and Display

As the result of a harmonic measurement, a bargraph is displayed, with one bar for each of 64 possible harmonic frequencies. The amplitudes determined for each harmonic are indicated by a colored bar. The results for each active input channel are displayed in a different color. The values are scaled in dB or percent, in relation to the level at the fundamental frequency. If a limit is defined, either manually or predefined by a standard, the limit is indicated by a blue horizontal line for each harmonic. If the measured value exceeds the limit, the background is highlighted red. The darker colored bar indicates the maximum value measured for the harmonic.

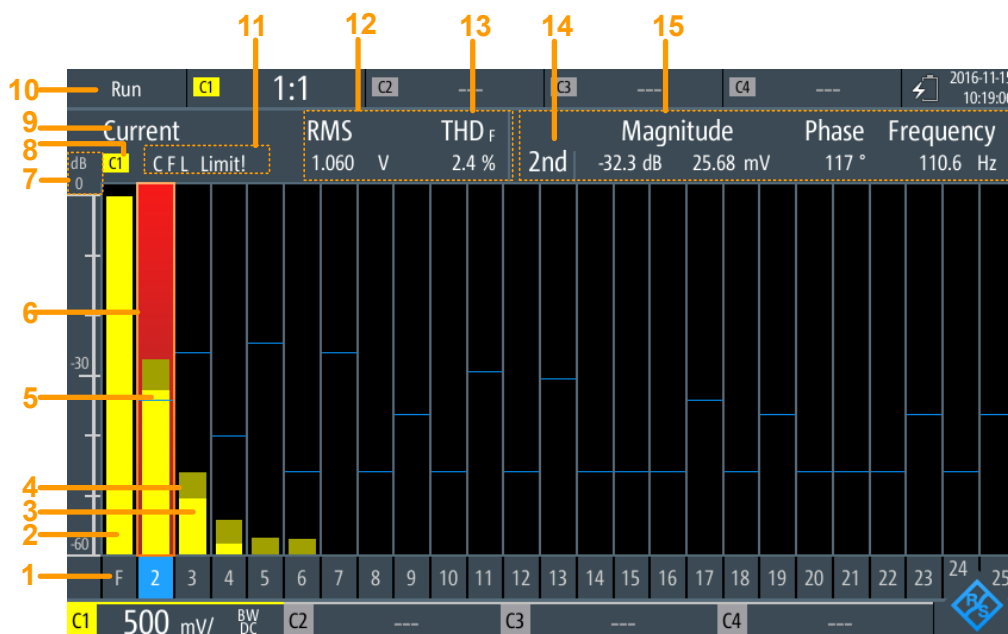

Figure 5-4: Harmonic results and display

(1) Order of harmonic.....	127
(2) Power level of fundamental frequency.....	127
(3+4) Power level of individual harmonics.....	127
(5+6) Limit line and check for individual harmonics.....	127
(7) Power level scale.....	128
(8) Input channel.....	128
(9) Result type for numeric results.....	128
(10) Operating status.....	128
(11) Error indicator.....	128
(12) RMS.....	129
(13) Total harmonic distortion (THD).....	129
(14) Selected harmonic.....	129
(15) Numeric results for selected harmonic.....	130

(1) Order of harmonic

Results are displayed for each of 64 possible harmonic frequencies. You can restrict the number of harmonics to be analyzed (see ["Display Harmonics, Max No Harmonics"](#) on page 133).

Remote command:

(determined by suffix <n> in remote command)

(2) Power level of fundamental frequency

The calculated power level at the fundamental frequency. The graphical level results are indicated in relation to the power level of the fundamental frequency. Thus, this bar is always at 100 % or 0 dB.

Remote command:

[HARMonic:RESult<m>:HARMonics1:ABSMagnitude?](#)

(3+4) Power level of individual harmonics

For each harmonic and each input channel, a colored bar indicates calculated power level at the selected harmonic frequency, set in relation to the power level of the fundamental frequency. The color of the bar corresponds to the color of the input channel.

The brighter colored bar is the current value, while the darker colored bar is the maximum value in the current measurement.

Remote command:

[HARMonic:RESult<m>:HARMonics<n>:ABSMagnitude\[:CURRent\]?](#)

on page 325

[HARMonic:RESult<m>:HARMonics<n>:ABSMagnitude:MAXimum?](#) on page 325

[HARMonic:RESult<m>:HARMonics<n>:ABSMagnitude:MINimum?](#) on page 325

[HARMonic:RESult<m>:HARMonics<n>:RELMagnitude\[:CURRent\]?](#)

on page 328

[HARMonic:RESult<m>:HARMonics<n>:RELMagnitude:MAXimum?](#) on page 328

[HARMonic:RESult<m>:HARMonics<n>:RELMagnitude:MINimum?](#) on page 328

(5+6) Limit line and check for individual harmonics

If a limit is defined for the individual harmonic, it is indicated in the graphic (see ["Limits, Loaded File"](#) on page 132). If the measured value exceeds the limit line, the background of the harmonic bar is highlighted red.

Remote command:

[HARMonic:RESult<m>:HARMonics<n>:LIMit?](#) on page 326

[HARMonic:RESult<m>:HARMonics<n>:LIMCheck?](#) on page 325

[HARMonic:RESult<m>:HARMonics<n>:LIMViolation?](#) on page 326

(7) Power level scale

Indicates whether the bargraph results are displayed in percent or dB.

Remote command:

[HARMonic:SCALE](#) on page 322

(8) Input channel

Harmonics measurement is performed on the data captured from one of the active input channels. The measurement can be performed on all channels simultaneously. The bars and numeric results for each channel are displayed in the same color as the channel indicator.

Remote command:

[CHANnel<m>:STATe](#) on page 252

(9) Result type for numeric results

Either the currently measured numeric values, or the minimum or maximum values can be displayed. The selected result type is indicated above the diagram. The bargraph always displays both the current and the maximum values.

In addition, an average over several measurements can be calculated (not indicated in the diagram.)

Remote command:

[HARMonic:STATistic](#) on page 322

(10) Operating status

Indicates the status of the harmonic measurement ("Hold"/"Run").

(11) Error indicator

If an error occurs during the measurement, an indicator is displayed above the bargraph. These indicators remain visible throughout the measurement, for all acquisitions. In addition, the long form of the error is indicated, blinking, for the duration of the acquisition in which an error occurs only.

The following errors may be indicated:

- **"C"** (Clipping)
The amplitudes determined for each frequency must be within the currently defined amplitude range in order to be measured correctly. If the signal is not entirely within the defined range, a "Clipping" message is displayed next to the channel indicator in the numeric result area of the screen. The measurement is invalid and no results are calculated.
To change the amplitude range, use the [RANGE keys](#) or the AUTOSSET function.
- **"F"** (Frequency)
If the specified [fundamental frequency](#) $\pm 10\%$ is not detected in the signal, the measurement is invalid.
- **"L"** (Limit)

If a limit check is activated and the measured value exceeds the specified limit for a harmonic, a limit violation has occurred. The background of the harmonic is highlighted red.

Remote command:

[HARMonic:RESult<m>:CLIPping?](#) on page 324

[HARMonic:RESult<m>:FRQMissing?](#) on page 324

[HARMonic:RESult<m>:LIMViolation?](#) on page 328

(12) RMS

The calculated root mean square (RMS) amplitude in the entire signal, that is: for all harmonics and the fundamental frequency.

$$U_{RMS} = \sqrt{\frac{1}{n} \cdot \sum_{k=0}^{N-1} u^2(k)}$$

Remote command:

[HARMonic:RESult<m>:RMS\[:CURRent\]?](#) on page 329

[HARMonic:RESult<m>:RMS:MINimum?](#) on page 329

[HARMonic:RESult<m>:RMS:MAXimum?](#) on page 329

(13) Total harmonic distortion (THD)

THD (total harmonic distortion), that is: the root mean square (RMS) amplitude (voltage or current) of the harmonics.

The value is provided either:

- Relative to the RMS amplitude at the fundamental frequency (first harmonic, THD_F):

$$THD_F = \frac{1}{U_{RMS,1}} \cdot \sqrt{\sum_{i=2}^{64} U_{RMS,i}^2}$$

- Relative to the total power of the signal (THD_R):

$$THD_R = \frac{THD_F}{\sqrt{1 + THD_F^2}}$$

Remote command:

[HARMonic:RESult<m>:THD\[:CURRent\]?](#) on page 330

[HARMonic:RESult<m>:THD:MINimum?](#) on page 330

[HARMonic:RESult<m>:THD:MAXimum?](#) on page 330

[HARMonic:THDType](#) on page 323

(14) Selected harmonic

Some results are provided for a single, selected harmonic. You select the harmonic by tapping the number at the bottom of the bargraph. The selected harmonic is highlighted.

Remote command:

(determined by suffix <n> in remote command)

(15) Numeric results for selected harmonic

The following numeric results are displayed for the (14) Selected harmonic:

- Order of the harmonic
- Magnitude (relative to (2) Power level of fundamental frequency and absolute value)
- Phase (percent or dB, depending on Scale setting)
- Frequency

Remote command:

`HARmonic:RESult<m>:HARMonics<n>:ABSMagnitude[:CURRent]?`

on page 325

`HARmonic:RESult<m>:HARMonics<n>:ABSMagnitude:MINimum?` on page 325

`HARmonic:RESult<m>:HARMonics<n>:ABSMagnitude:MAXimum?` on page 325

`HARmonic:RESult<m>:HARMonics<n>:RELMagnitude[:CURRent]?`

on page 328

`HARmonic:RESult<m>:HARMonics<n>:RELMagnitude:MINimum?` on page 328

`HARmonic:RESult<m>:HARMonics<n>:RELMagnitude:MAXimum?` on page 328

`HARmonic:RESult<m>:HARMonics<n>:PHASe?` on page 327

`HARmonic:RESult<m>:HARMonics<n>[:FREQuency]?` on page 328

5.3.3 Performing a Harmonic Measurement

1. Select the "Harmonic" mode.
2. To adjust the instrument settings to the current input signal automatically, press AUTOSET.
The AUTOSET function detects the fundamental frequency in the signal automatically if it lies between 10 Hz and 1 kHz. If none of the predefined values (50 Hz, 60 Hz, 400 Hz) fit, a "User" value is set.
3. Alternatively to the AUTOSET function, define the "Fundamental Frequency" manually. Select "User" and enter the frequency.
4. If a "Clipping" message is displayed next to the channel indicator in the numeric result area of the screen, the signal is not entirely within the defined measurement range. Use the AUTOSET key or the RANGE keys to correct the range.
5. To perform a limit check, do one of the following for the "Limits" setting:
 - To check the limits specified by the standard, select "EN50160".
 - To configure user-specified limits in a file, select "User" and open the .CSV file.
6. To restrict the number of harmonics to be displayed in the bargraph, use the "Display Selection" setting.
Select a predefined selection, or define the number in the "Max No Harmonics" field.
7. To display the results for a specific harmonic, select the number below the bar in the graph.

8. To calculate the average results over several measurements, select "Average" and define the number of results to consider.
9. To clear the result data used for statistical evaluation and start a new measurement, select "Clear Results".

To save the results to a file

1. Press the FILE key.
2. Select "Harmonics".
3. Check the "Harmonic Directory" and the "Filename Base". Adjust if necessary.
4. Select "Save".

For details on the format of the result file, see [Chapter 5.3.6.2, "Harmonic Results Export File Format"](#), on page 135.

5.3.4 Harmonic Mode Settings

Access: "Harmonic" menu

CH <N>.....	131
Scale.....	131
THD Type.....	131
Statistic.....	132
Clear Results.....	132
Fundamental Frequency, Value.....	132
Limits, Loaded File.....	132
Open.....	133
Display Harmonics, Max No Harmonics.....	133
Average.....	133

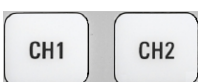

CH <N>

Selects the channel for which the captured data is analyzed in "Harmonic" mode. Harmonic measurements can be performed on all channels simultaneously. The results are indicated by different colored bars and numbers, corresponding to the channel button color.

Remote command:
[CHANnel<m>:STATe](#) on page 252

Scale

Switches the scale for the measured harmonic levels between logarithmic (dB) and linear (percent). The values are relative to the level measured for the fundamental frequency.

Remote command:
[HARMonic:SCALE](#) on page 322

THD Type

Switches between different calculation methods for the total harmonic distortion.

"THD _F "	The RMS amplitude (voltage or current) of the harmonics relative to the RMS amplitude of the fundamental component
"THD _R "	The RMS amplitude of the harmonics relative to the RMS amplitude of the input signal

Remote command:

[HARMonic:THDType](#) on page 323

Statistic

By default, the numeric results indicate the currently measured values. Optionally, you can switch to the minimum or maximum values. Which value is calculated is indicated in the result display (see "(9) Result type for numeric results" on page 128).

Note: The bargraph always displays both the current and the maximum values.

Remote command:

[HARMonic:STATistic](#) on page 322

Clear Results

Clears the results for previous acquisitions used in statistical evaluation (see "Statistic" on page 132 and "Average" on page 133).

Remote command:

[HARMonic:CLEar](#) on page 319

Fundamental Frequency, Value

Defines the basis of the harmonics measurement. Harmonics are determined as multiples of this frequency.

For a user-defined frequency, select "User" and enter the "Value".

If the specified frequency $\pm 10\%$ is not detected in the signal, the measurement is invalid. An "F" is displayed as an error indicator.

Remote command:

[HARMonic:FUNDamental:TYPE](#) on page 320

[HARMonic:FUNDamental:USER](#) on page 321

[HARMonic:RESult<m>:FRQMissing?](#) on page 324

Limits, Loaded File

Defines for which harmonics a limit check is to be performed. If a limit check is activated and the specified limit is exceeded for a harmonic, the background of the harmonic is highlighted red in the graphic. In addition, an "L" is displayed as an error indicator.

"Limit!" is indicated during the acquisition in which the violation occurs.

If the number of harmonics to be analyzed is restricted by a standard or a user-defined file, only the results for those harmonics can be displayed or exported (see also "Display Harmonics, Max No Harmonics" on page 133).

"None" No limit check is performed. All 64 harmonics can be displayed and exported.

"EN50160" Limits are checked according to the predefined values in the EN50160 standard. Only specific harmonics are selected for analysis.

"User" Limits are checked according to the values in a user-defined file. For details on the required file format, see [Chapter 5.3.6.1, "Limit File Format"](#), on page 134.

If a user-defined limit file is loaded for harmonics measurement, only the results for the specified harmonics are calculated, displayed, and exported. A limit check is performed only for those harmonics for which a limit value is defined.

If "User" is selected, the "Loaded File" field indicates the currently loaded file.

Select the file that contains the user-defined limits using the [Open](#) function.

Remote command:

[HARMonic:LIMits:TYPE](#) on page 322

Open

Opens a user-defined file that contains the selection of harmonics and, optionally, the limits for individual harmonics.

The "Loaded File" field indicates the currently loaded file.

Note that this setting is only available if [Limits](#) is set to "User".

Remote command:

[HARMonic:LIMits:NAME](#) on page 322

[HARMonic:LIMits:LOAD](#) on page 321

[HARMonic:RESult<m>:NOHarmonics?](#) on page 329

[HARMonic:FUNDamental:CURRent?](#) on page 320

Display Harmonics, Max No Harmonics

Determines the number of harmonics to be displayed in the bargraph. Up to 64 harmonics can be displayed. By decreasing the number of harmonics, the bargraph becomes easier to analyze.

Note that this setting only affects the graphical result display. It has no effect on the measurement results or the selection of harmonics for which results are provided during a file export (manually or via remote command). For that purpose, see [Limits](#).

Harmonics that were previously eliminated by the [Limits](#) setting cannot be displayed.

To restrict the number of harmonics to display, select a predefined selection, or "User" and enter the "Max No Harmonics". All harmonics of an order smaller than or equal to the specified value (and selected for analysis) are displayed.

Remote command:

[HARMonic:DISPlay:TYPE](#) on page 319

[HARMonic:DISPlay:USER](#) on page 320

[HARMonic:RESult<m>:NOHarmonics?](#) on page 329

Average

Determines the number of acquisitions for which the results are averaged. By default, no averaging is performed.

Note that invalid measurements (for example due to clipping or a missing fundamental frequency) are not considered for averaging.

To clear the results for previous acquisitions used for averaging, select [Clear Results](#).

Remote command:

[HARMonic:AVERage](#) on page 319

5.3.5 Harmonic File Functions

Access: FILE > "Harmonics"

The results of a harmonic measurement can be exported similarly to a waveform (see also [Chapter 11, "Documenting Results"](#), on page 219). The OneTouch functionality is also available (see [Chapter 11.6, "Quick Save with OneTouch"](#), on page 230).

For details on the export file format, see [Chapter 5.3.6.2, "Harmonic Results Export File Format"](#), on page 135.

Save, Save As

Save the harmonic results. The functions are available if the instrument is in "Harmonics" mode.

"Save" Saves the file in the defined "Harmonic Directory" using the autonaming pattern.

"Save As" Opens a file explorer where you can select the directory and enter the filename.

Remote command:

[HARMonic:EXPort:SAVE](#) on page 324

Harmonic Directory

Defines the directory where the harmonic results files are stored. If a USB flash drive is connected, the instrument stores the data to this external device by default.

Remote command:

[HARMonic:EXPort:NAME](#) on page 323

Filename Base

Defines the first part of the filename. The complete filename pattern is:

```
<filename base>_<date>_<time>.csv.
```

Remote command:

[HARMonic:EXPort:NAME](#) on page 323

5.3.6 Reference: Harmonic Results and Limit File Formats

5.3.6.1 Limit File Format

The limit file defines which harmonics are of interest for analysis, and optionally, the limits against which each harmonic is to be tested. If a user-defined limit file is loaded for harmonics measurement, only the results for the specified harmonics are calcula-

ted, displayed, and exported. A limit check is performed only for those harmonics for which a limit value is defined.



Sample file

A sample limit file is provided on the instrument:

C:\Users\<>user_name>\Rohde-Schwarz\RTH\Harmonic\LimitExample.csv

The file format is a comma-separated list (.csv). At least the following contents must be included:

Header:

<Device>,Version,<file_version>

Harmonics,Limit[%]

Values:

<Order of harmonic>, <limit value in % of fundamental>



- Comments introduced by "#" are allowed.
- If a limit is not provided for a harmonic, the harmonic is displayed and its results are included in the export, but not in the limit check.
- The fundamental is always displayed and need not be included in the list.

Example:

```
RTH,Version,1.0
Harmonics,Limit[%]
2,10.5
4,0.004
20,3.7
10
13,0.01
3,0.01
```

5.3.6.2 Harmonic Results Export File Format

The harmonic results export file format is similar to a waveform export file; it is also stored in CSV format. You can convert the comma-separated text to columns (see [Chapter 11.4.3.3, "Converting CSV to Excel Files"](#), on page 229).

The harmonics results file contains some general header data and then a set of result data for each harmonic. A maximum of 64 results can be provided, but the actual number of harmonics may be restricted (see ["Limits, Loaded File"](#) on page 132). Each set of data contains the results for a specific harmonic in each input channel.

Table 5-5: Header data (converted to table)

Harmonic Results		[Description - not included in file]
Model	RTH1004	

SerialNumber	xxxxx				
Firmware Version	'1.50'				
ID	CH1	CH2	CH3	CH4	Results for each channel
NbOfResults [n]					Number of results included in averaging and statistics operations
RMS Unit					Unit used for RMS results
RMS					Current RMS of the signal power (
RMS Max					Maximum RMS of the signal power
RMS Min					Minimum RMS of the signal power
THDf/ THDr [%]					Current THD in relation to the RMS amplitude of the fundamental frequency (THDf) or the total power of the signal (THDr)
THDf/ THDr Max [%]					Maximum THD
THDf/ THDr Min [%]					Minimum THD
Clipping [bool]					Clipping occurred during the measurement?
FrequencyMissing [bool]					Fundamental frequency could not be measured?
LimitViolation [bool]					A limit was exceeded?

Table 5-6: Results for individual harmonics (converted to table data)

		Ch 1						Ch 2 ...		
Harmonic ID	Limit	Freq.	Magn. current	Magn. max	Magn. min	Phase	Limit violation	Limit	Freq.	Magn. current
[n]	[%]	[Hz]	[V]	[V]	[V]	[deg]	[bool]	[Hz]	[V]	[V]
1										
2										
...										

6 Multimeter Measurements

The 4-channel R&S RTH1004 has 4 software-based voltmeters, which can measure in parallel. For each voltmeter you can select the source and measurement type. See [Voltmeter \(R&S RTH1004\)](#).

The 2-channel R&S RTH1002 has a hardware-based digital multimeter with two separate banana plug inputs for various multimeter measurements. Except for voltages, the DMM can also measure resistance, capacitance, temperature and more. See [Digital Multimeter \(R&S RTH1002\)](#).

6.1 Digital Multimeter (R&S RTH1002)

The hardware-based digital multimeter features various multimeter measurements. Except for voltages, the DMM can also measure resistance, capacitance, temperature and more.

The R&S RTH can run one DMM measurement at a time, the maximum resolution is 10000 counts and 4 digits.

In "Meter" mode, a separate self-alignment of the meter inputs is available, see [Chapter 12.3, "Selfalignment"](#), on page 234.

All remote commands for configuration and measuring are listed in [Chapter 14.7, "Digital Multimeter \(R&S RTH1002\)"](#), on page 330.

6.1.1 Accessing the Meter Mode

► There are several ways to start the multimeter mode:

- Press the DMM key.



- Press the MODE key, and select "Meter".

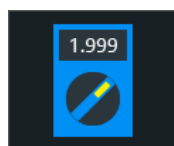
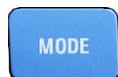

- To start relative measurements, press the DMM REL key.

The multimeter interface is displayed, and the measurement is started immediately.

6.1.2 Display and Control

The multimeter display shows detailed results and setup icons.

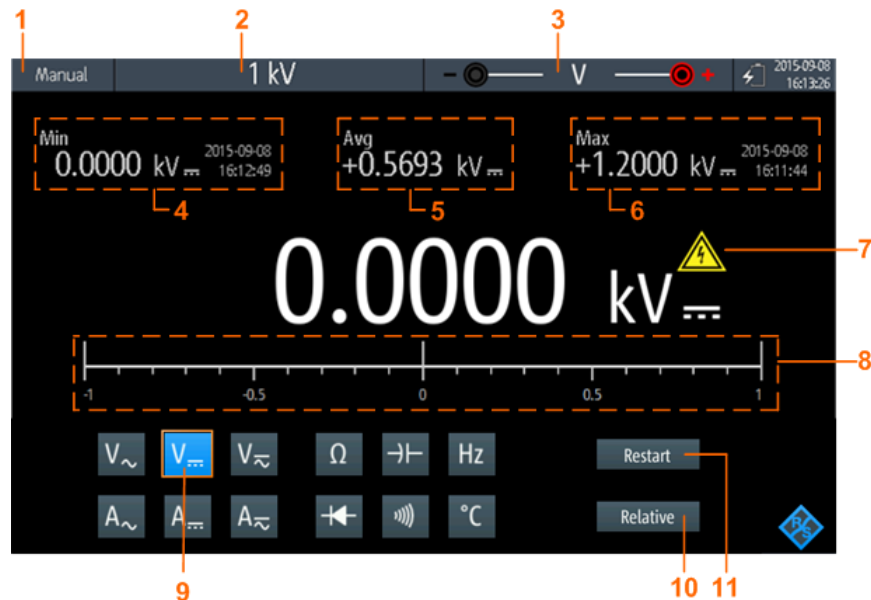



Figure 6-1: Display of the digital multimeter

- 1 = Measurement state. "Manual" or "Auto": running measurement with manual or automatic range. "Hold": stopped measurement.
- 2 = Measurement range
- 3 = Test lead connection including polarity
- 4 = Minimum value and timestamp
- 5 = Average value
- 6 = Maximum value and timestamp
- 7 = Warning sign, shows up if the measured value is higher than 30 V
- 8 = Bargraph displaying the measured value
- 9 = Measurement type
- 10 = Activates or deactivates relative measurement
- 11 = Restarts the measurement and resets all values

In meter mode, the keys behave slightly different from scope mode:

- The AUTASET key toggles the range mode: autoranging and manual range setting.
- The vertical RANGE and POS keys adjust the measurement range.
- The MEAS key opens the "Meter" menu.
- The following keys work as usual: FILE, , , PRESET, MODE, BACK.
- The CH keys switch back to the scope mode.
- All other keys do not work.

6.1.3 Running Multimeter Measurements

1. Connect the test leads to the meter inputs.

2. Select the "Meter" mode.
3. Select the measurement type (no. 9 in [Figure 6-1](#)).
4. To set the range mode to autoranging or manual range setup, press AUTOSET.
5. If you are in manual range mode, adjust the measurement range: Press the RANGE keys.
6. For current and temperature measurements, adjust the "Probe Setting".
7. For continuity measurement, adjust the "Resistance Threshold".
8. If you want to get relative result values:
 - a) Activate "Relative" (no. 10).
 - b) To set a user-defined reference value, open the "Meter" menu.
 - c) Activate "Reference", and enter the value in "Reference Manual".
9. To stop the meter measurement, press the RUN STOP key.

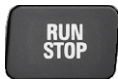

The status "Hold" is displayed on the upper left. Stopping the measurement does not delete statistical values. The measurement continues when you press RUN STOP again.

6.1.4 Settings

Access: "Meter" menu

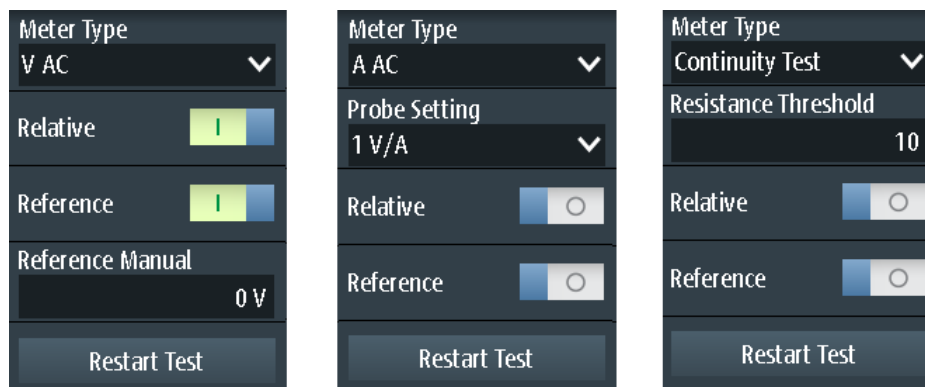

Figure 6-2: Digital multimeter settings

Meter Type

Sets the measurement type for the multimeter.

Meter icon	"Meter Type"	Description
	"V AC"	AC voltage measurement
	"V DC"	DC voltage measurement
	"V AC+DC"	AC+DC voltage (RMS) measurement

Meter icon	"Meter Type"	Description
	"A AC"	AC current measurement
	"A DC"	DC current measurement
	"A AC+DC"	AC+DC current (RMS) measurement
	"Resistance"	Resistance measurement
	"Continuity Test"	Continuity measurement
	"Diode Test"	Diode measurement
	"Capacitance"	Capacity measurement
	"Temperature"	Temperature measurement (an adapter is required)
	"Frequency"	Frequency measurement

Remote command:

`METer<m>:SENSe:FUNction` on page 353

Resistance Threshold

This setting is only relevant for continuity measurement. If the measured voltage drops below the "Resistance Threshold", the instrument beeps.

Probe Setting

Sets the sensitivity factor of the current probe for current measurements.

Sets the adapter type for temperature measurements.

Relative

Activates or deactivates relative measurement. If you activate this function, the currently measured value is taken as reference value. Instead of the bargraph, the reference value and the measured value are displayed. You can also set a desired value as reference value, see "Reference/Reference Manual" on page 141.

You can also activate or deactivate relative measurement by pressing DMM REL.

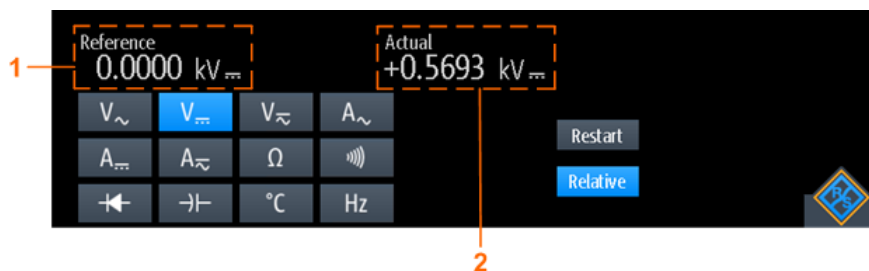

- 1 = Reference value
- 2 = Actual value relative to reference value

Remote command:

[Chapter 14.7.3, "Relative Measurements"](#), on page 338...

Reference/Reference Manual

"Reference" activates or deactivates the setting of a manual reference value.

If active, enter the reference value in "Reference Manual".

Restart Test

Restarts the measurement.

RANGE / POS

In meter mode, the vertical RANGE and POS keys adjust the DMM measurement range.

Remote command:

[Chapter 14.7.2, "Measurement Configuration"](#), on page 331

6.2 Voltmeter (R&S RTH1004)

The software-based voltmeter features AC, DC, AC+DC voltage measurements. Current measurements are also possible if you use a shunt resistor or I/U converter.

The R&S RTH can run four voltmeter measurement in parallel, the maximum resolution is 999 counts and 3 digits.

All remote commands for configuration and measuring are listed in [Chapter 14.8, "Voltmeter \(R&S RTH1004\)"](#), on page 346.

6.2.1 Accessing the Meter Mode

1. Press the MODE key.

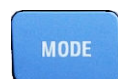

2. Select "Meter".

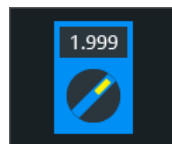

The multimeter interface is displayed.

6.2.2 Display and Control

The voltmeter display shows all 4 voltmeters at a glance, or only one voltmeter with details and setup icons.

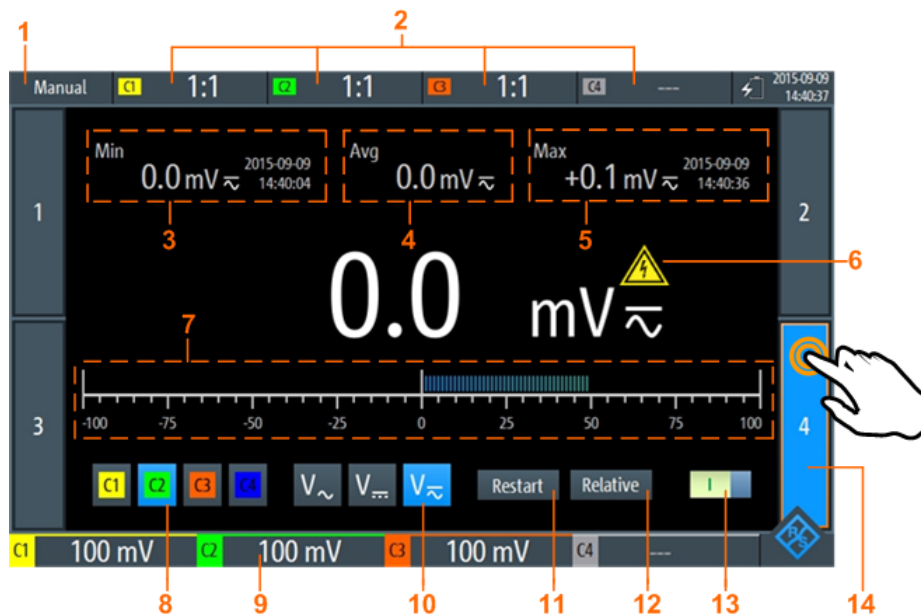

Figure 6-3: One-voltmeter-view

- 1 = Measurement state. "Manual": running measurement. "Hold": stopped measurement.
- 2 = Probe settings
- 3 = Minimum value and timestamp
- 4 = Average value
- 5 = Maximum value and timestamp
- 6 = Warning sign, shows up if the measured value is higher than 30 V
- 7 = Bargraph displaying the measured value
- 8 = Measurement source (input channel). Selected source is highlighted.
- 9 = Measurement ranges of active channels
- 10 = Measurement type (AC, DC or AC+DC). Selected type is highlighted.
- 11 = Restarts the measurement and resets all values
- 12 = Activates or deactivates relative measurement
- 13 = On/Off-Switch to turn selected meter on or off
- 14 = Displayed voltmeter, indicated by highlighted number

The buttons at the bottom of the display offer the following quick settings:

- [Input Signal](#)
- [Measure Type](#)
- [Restart Test](#)
- [Relative](#)

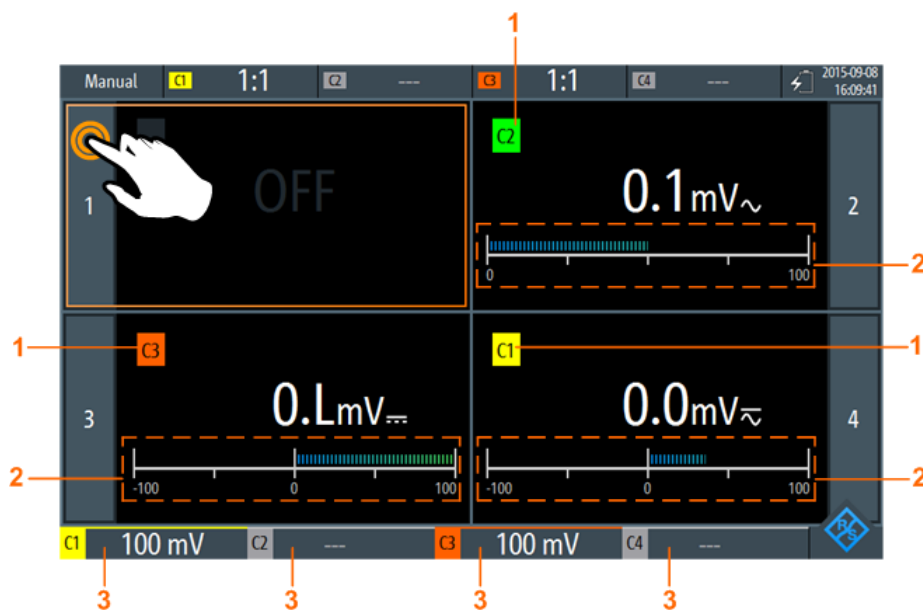



Figure 6-4: Four-voltmeter-view

- 1 = Channel measured by the voltmeter
- 2 = Bargraph displaying the measured value
- 3 = Measurement ranges of active channels

In meter mode, the keys behave different from scope mode:

- The vertical RANGE and POS keys both adjust the measurement range of the selected channel.
- The MEAS key opens the "Meter" menu.
- The following keys work as usual: FILE, , , PRESET, MODE, BACK.
- All other keys do not work.



Displaying voltmeters

- ▶ To switch to one-voltmeter-view, use one of the following methods:
 - Tap the meter number as shown in [Figure 6-4](#).
 - Turn the wheel to select a voltmeter, and press the wheel button to open it.
- ▶ To view all 4 voltmeters, use one of the following methods:
 - Tap the highlighted number of the opened voltmeter as shown in [Figure 6-3](#).
 - Press BACK.

6.2.3 Running Voltmeter Measurements

1. Set up the channels for voltmeter measurements.
 - a) Select the "Vertical" menu.

- b) Adjust the "Probe Setting" for all measured channels.
See also "Probe Setting" on page 39.

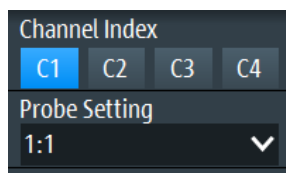

2. If the 4-voltmeter-view is shown, switch to the one-voltmeter-view. See "Displaying voltmeters" on page 143.
3. Select the channel to be measured (no. 8 in Figure 6-3).
4. Select the measurement type (no. 10).



5. Activate the voltmeter (no. 13)
6. To adjust the measurement range manually, press the RANGE keys.
7. If you want to get relative result values:
 - a) Activate "Relative" (no. 12).
 - b) To set a user-defined reference value, open the "Meter" menu.
 - c) Activate "Reference", and enter the reference value in "Reference Manual".

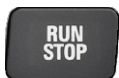

8. To stop the meter measurement, press the RUN STOP key.

The status "Hold" is displayed on the upper left. Stopping the measurement does not delete statistical values. The measurement continues when you press RUN STOP again.

Alternatively, you can select the voltmeter and adjust the meter settings in the "Meter" menu.

6.2.4 Voltmeter Settings

Access: "Meter" menu

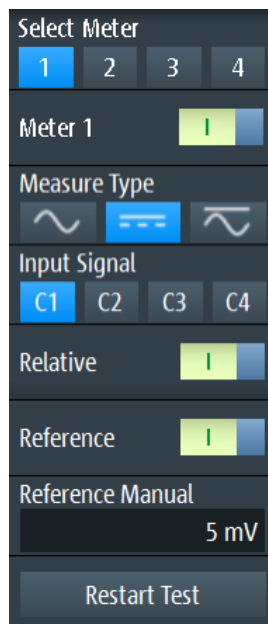

Figure 6-5: Voltmeter settings

Select Meter

Selects one of the 4 voltmeters and displays its settings in the menu.

Meter <n>

Switches the selected meter on or off.

Remote command:

[METer<m>:SENSe:STATe](#) on page 347

Measure Type

Sets the measurement type for the selected meter.

Note: The AC coupling is activated if the selected channel is only used for AC measurements. If the selected channel is also used for DC or AC+DC measurement, the AC coupling is deactivated and the AC value is calculated out of the AC+DC and DC values. The precision of the results is reduced.

Menu icon	Meter icon	Description
		AC voltage or current measurement
		AC+DC voltage or current (RMS) measurement
		DC voltage or current measurement

Note: An external shunt resistor or I/U converter is needed for current measurement.

Remote command:

[METer<m>:SENSe:FUNctIon](#) on page 353

Input Signal

Selects the channel which is measured by the selected meter.

Remote command:

[METer<m>:SENSe:SOURce](#) on page 347

Relative

Activates or deactivates relative measurement. If you activate this function, the currently measured value is taken as reference value. Instead of the bargraph, the reference value and the measured value are displayed (see [Figure 6-6](#)). You can also set a desired value as reference value, see "[Reference/Reference Manual](#)" on page 146.

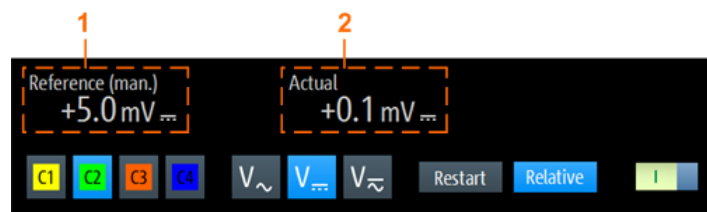

Figure 6-6: Relative measurement

1 = Reference value

2 = Measured value relative to reference value

Remote command:

[Chapter 14.8.3, "Relative Measurements"](#), on page 351

Reference/Reference Manual

"Reference" activates or deactivates the manual reference value.

If active, enter the reference value in "Reference Manual".

Restart Test

Restarts the measurement and also restarts statistical calculation.

RANGE / POS

In meter mode, the vertical RANGE and POS keys adjust the measurement range of the selected channel.

Remote command:

[Chapter 14.8.2, "Measurement Configuration"](#), on page 347

7 Data Logging

The data logger records scope or meter data captured of up to 4 different measurements. The logging can last up to 23 days. The records are displayed as an on-screen-chart and can be stored in 10 different slots. Using the "Zoom" and "Cursor" functions, logged data can be analyzed.

7.1 Accessing the Logger Mode

1. Press the MODE key.

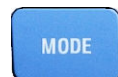

2. Select "Logger".



The logger interface is displayed.

If a scope measurement or meter measurement is running, the logging is started automatically when you enter the logger mode.

7.2 Logger Display

If you log data of scope measurements, you can log all active measurements at once. The logger display shows all logs with latest results at a glance, or one log with latest and statistical results.

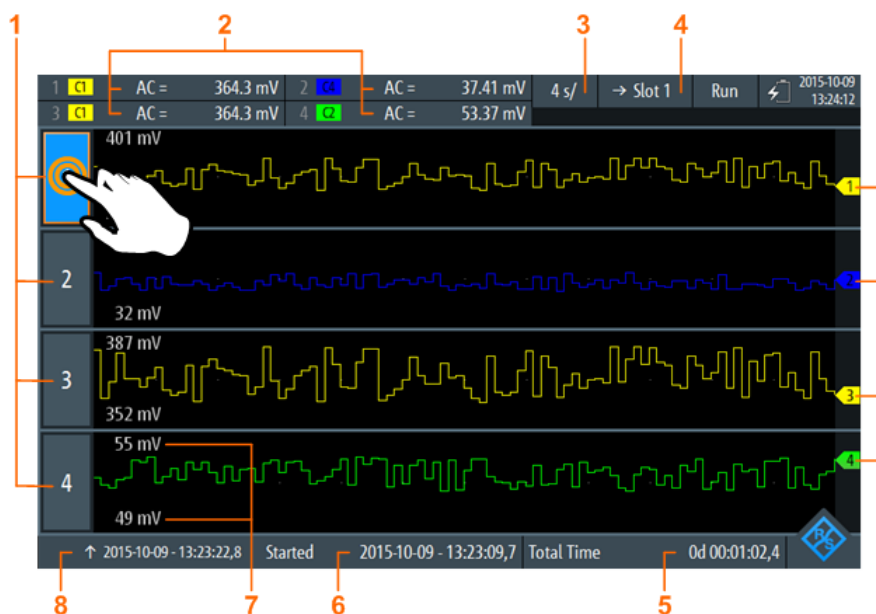

Figure 7-1: Logger display, view of all logged scope measurements

- 1 = Logger channel, each logger channel records one measurement
- 2 = Latest values of the logged measurements (depends on logging type and measurement type)
- 3 = Time basis
- 4 = In run mode (recording): →Slot <x> is the selected slot. In stop mode: Slot <x> is the active slot where data has been stored to or loaded from
- 5 = Recording time
- 6 = Start time
- 7 = Upper and lower scaling value of each measurement
- 8 = Time stamp of the left side of the display

Displaying logged measurements



1. To switch to one-log-view, use one of the following methods:
 - Tap on one of the logged measurements as shown in [Figure 7-1](#).
 - Press the assigned CH key.
2. To view all logs, use one of the following methods:
 - Tap the highlighted number of the open logger channel.
 - Press the CH key of the open logger channel.

7.3 Logging Data

You can log up to four different scope measurements or meter measurements simultaneously.

Before you start the logging, set up and activate the measurements that you want to log. See:

- [Chapter 3.2, "Automatic Measurements"](#), on page 75
- [Chapter 6, "Multimeter Measurements"](#), on page 137

1. Access the logger mode, see [Chapter 7.1, "Accessing the Logger Mode"](#), on page 147.
2. Select the "Logger" menu.
3. If data logging is running, press RUN/STOP to stop the logging. The logged data is stored automatically. You can adjust the logger settings only if logging is stopped.
4. Select the source that you want to log.
5. Select the sample rate.
6. Select the horizontal scale.
By default, the horizontal scale is set to "auto". In this case, all logged data are always displayed, and the scaling is adjusted automatically when the amount of data increases..
7. Select the slot, where the logged data will be stored.
8. To start logging, press the RUN STOP key.

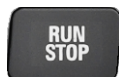

When you stop logging, the logged data is stored automatically in the selected slot. Each slot stores the data of a single logging period. If you use the slot a second time, the stored data is overwritten.

7.4 Logger Settings

Access: "Logger" menu

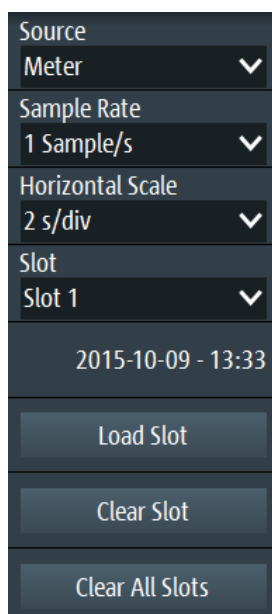

Source

Selects the logger source: "Scope" or "Meter".

Changing the source is only possible in stop mode.

Remote command:

[LOGGer : SOURce](#) on page 365

Sample Rate

Selects the number of log samples per second.

Changing the sample rate is only possible in stop mode.

Remote command:

[LOGGer : TIMebase : SRATe](#) on page 365

Horizontal Scale

Selects the horizontal scale of the logged data.

The horizontal scale is set to "auto" by default. In this case, all logged data is always displayed.

Remote command:

[LOGGer : TIMebase : SCALe](#) on page 366

Slot

Selects one of the 10 memory slots for storing the logged data. Data is stored automatically to the selected slot if you stop the acquisition or press PRESET.

If data is stored in a slot, the start time of the stored data is displayed in the menu. You can change the slot during recording.

Remote command:

[LOGGer : SLOT : CURRent](#) on page 366

Load Slot

Loads the stored log data of the selected slot.

Only possible while logging is stopped.

Remote command:

[LOGGer : SLOT : LOAD](#) on page 366

Clear Slot

Deletes the log data of the selected slot.

Only possible while logging is stopped.

Remote command:

[LOGGer : SLOT : CLear](#) on page 366

Clear All Slots

Deletes the log data of all slots.

Only possible while logging is stopped.

Remote command:

[LOGGer : ACLR](#) on page 367

7.5 Analyzing Logged Data

You can analyze logged data using the "Cursor" and the "Zoom". To analyze logged data at a later time, the data is stored automatically, and you can load the stored data to the display.

7.5.1 Cursor

To analyze logged data, you can use cursor measurements, see also [Chapter 3.3, "Cursor Measurements"](#), on page 81.

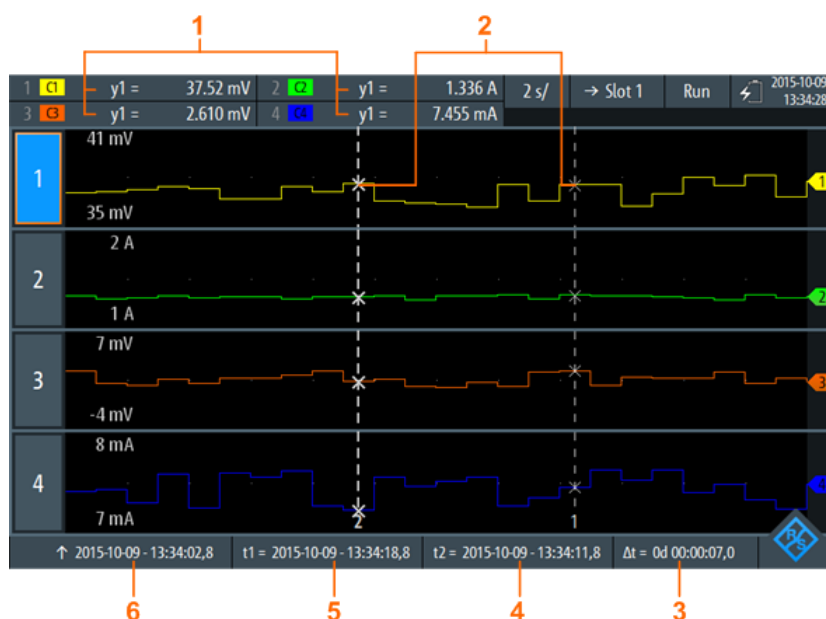

Figure 7-2: Logger display with cursors

- 1 = Values of the crossings between the selected cursor line and the waveform
- 2 = Cursor lines
- 3 = Absolute value of the time difference between the cursor lines $\Delta t = |t1-t2|$
- 4 = Position of the cursor line 2
- 5 = Position of the cursor line 1
- 6 = Time stamp of the logged signal on the left side of the display



To select one of the two cursor lines, tap a cursor line, or use the wheel to navigate and select. The selected line is highlighted by a bold line.

Remote commands for cursor results:

- `LOGGer:CURSor<m>:RESult<n>[:AMPLitude]?` on page 368
- `LOGGer:CURSor:RESult<n>:DELta?` on page 368
- `LOGGer:CURSor<m>:POSition?` on page 369
- `LOGGer:CURSor:TDELta?` on page 369



The logger cursor only allows you to set a "Cursor Value". You cannot define the cursor "Type" and "Source" as you can in the "Scope" and "Mask" mode because these settings are not relevant for logging.



Description of settings

Access: "Cursor" menu

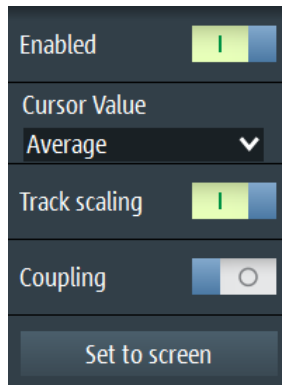

Figure 7-3: Cursor settings

Enable

Enables or disables the cursor measurement.

Remote command:

[LOGGer:CURSor:STATe](#) on page 367

Cursor Value

Sets the measured crossing point between the cursor lines and the waveform, see [Figure 7-4](#). These settings only apply if data logging is running for more than 2 days and 7 hours. After this time, the logger compresses 4 logging values into a "Minimum", "Average" and "Maximum" value.

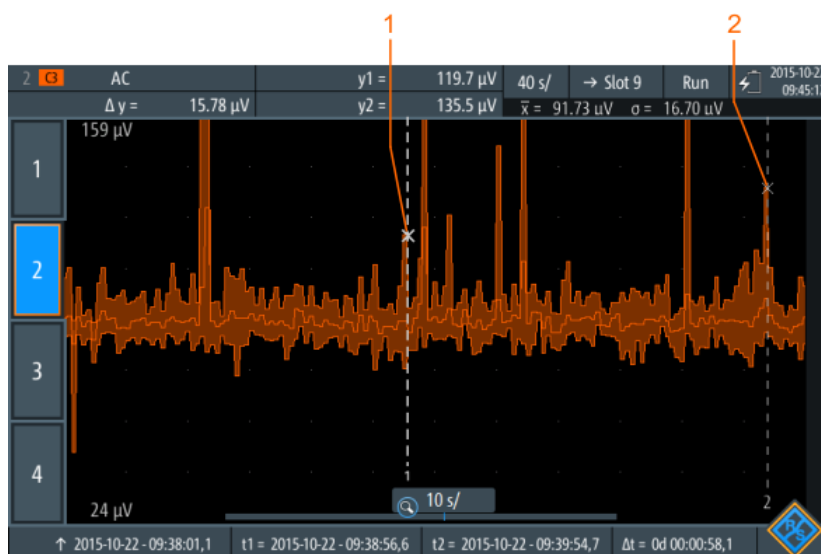

Figure 7-4: Logger cursor with summarized data

1 = Maximum value of cursor line 1
 2 = Maximum value of cursor line 2

Remote command:

[LOGGer:CURSor:TYPE](#) on page 367

Track scaling

If enabled, the position of the cursor lines is adjusted if the scale is changed. The cursor lines keep their relative position to the waveform.

If disabled, the cursor lines remain on their position on the display if the scaling is changed.

Remote command:

[LOGGer:CURSor:SCPLing](#) on page 367

Coupling

Couples the cursor lines so that the distance between the two lines remains the same if one cursor is moved.

Remote command:

[LOGGer:CURSor:COUPling](#) on page 368

Set to screen

Sets the cursors to a default position on the screen. This is helpful if the cursors have disappeared from the display or need to be moved for a larger distance.

Remote command:

[LOGGer:CURSor:SCReen](#) on page 368

7.5.2 Zoom

To analyze logged data, you can use the "Zoom" function, see also [Chapter 3.1, "Zoom"](#), on page 73.



The zoom is only available if enough data have been logged.

The zoom settings in logger mode are the same as in scope mode, but the time range is much longer.

If data logging is running for more than 2 days and 7 hours, the logger compresses 4 logging values into a minimum, average and maximum value, see [Figure 7-5](#).

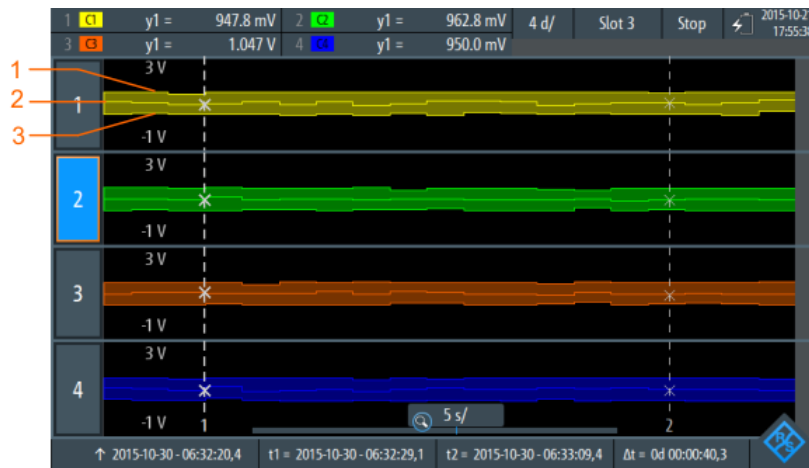

Figure 7-5: Logger zoom with summarized data

1 = Maximum values

2 = Average values

3 = Minimum values



Description of settings

Access: "Zoom" menu

Enabled	<input checked="" type="checkbox"/>
Horizontal Scale	1 s/div
Position Time	13 : 33 : 46 . 8
Position Date	2015 / 10 / 9

Figure 7-6: Zoom settings

Enable

Turns the zoom on or off.

Remote command:

[LOGGer: ZOOM: ENABLE](#) on page 369

Horizontal Scale

Sets the horizontal scale of the horizontal axis for all logged signals, in seconds per division.

Remote command:

[LOGGer:ZOOM:SCALE](#) on page 369

Position, Position Date

Sets the position of the zoomed area in relation to the left side of the display.

Remote command:

[LOGGer:Zoom:POSITION?](#) on page 370

7.5.3 Logger Statistics

Figure 7-7: Logger statistics

1 = Measurement results; display depends on the logger mode and the selected measurement

2 = Mean value statistic

3 = Standard deviation statistic

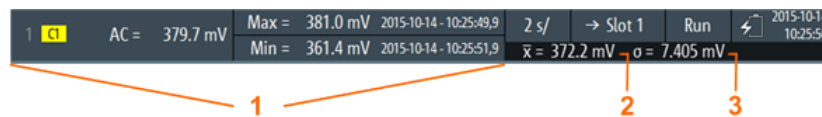

Statistics are only shown if a single log is displayed.

Remote commands for logger statistics:

- [LOGGer:RECORDing:START?](#) on page 370
- [LOGGer:RECORDing:TOTAL?](#) on page 370
- [LOGGer:MEASurement<m>:RESult:CURRentsampl?](#) on page 371
- [LOGGer:MEASurement<m>:RESult:MAXimum:POSITION?](#) on page 371
- [LOGGer:MEASurement<m>:RESult:MAXimum:VALue?](#) on page 371
- [LOGGer:MEASurement<m>:RESult:MINimum:POSITION?](#) on page 371
- [LOGGer:MEASurement<m>:RESult:MINimum:VALue?](#) on page 372
- [LOGGer:MEASurement<m>:RESult:MEAN?](#) on page 372
- [LOGGer:MEASurement<m>:RESult:STDDev?](#) on page 372
- [LOGGer:MEASurement<m>:ENABLEd?](#) on page 372
- [LOGGer:MEASurement<m>:TYPE?](#) on page 373
- [LOGGer:MEASurement<m>:SOURce?](#) on page 373

7.5.4 Loading Logged Data

Logged data can be loaded from the slot, in which they were stored.

1. Access the logger mode, see [Chapter 7.1, "Accessing the Logger Mode"](#), on page 147.
2. Select the "Logger" menu.
3. If a data logging is running, press RUN STOP to stop logging.
4. Select the slot with the logs that you want to display.
5. Tap "Load Slot" to display the stored logs.

7.5.5 Deleting Logged Data

Logs stored on the slots can be deleted individually or all together.

To delete logs of a single slot:

1. Select the slot with the logs which you want to delete.
2. Tap "Clear Slot".

To delete logs on all slots:

- ▶ Tap "Clear All Slots".

7.6 Logger Records

Export means to save a logger record (slot) to a CSV or MAT file for further analysis. Export is only possible if the instrument is in "Logger" mode. The instrument always saves the data of the last saved slot, you cannot select the slot to be stored.

You can also save the data of the measured waveforms when you are in logger mode. The waveform data has no time correlation to the logger data. For details of waveform export, see [Chapter 11.4, "Waveforms"](#), on page 224.

1. If data logging is running, press RUN/STOP to stop the logging. The logged data is saved automatically to the slot.
2. Press the FILE key.
3. Tap "Logger Records".
4. Tap "Export As".
5. Select the "File Type", enter the "File Name", and change the folder if necessary. If a USB flash drive is attached, the file is stored there. Otherwise, the file is stored in the `Export` folder on the microSD card.
6. Tap "Save".

The data of the last used slot is saved.

Remote commands:

- `LOGGer:SLOT:EXPort:NAME` on page 374
- `LOGGer:SLOT:EXPort:SAVE` on page 374

7.6.1 Logger Records in MATLAB

To analyze logger records in MATLAB, save the logger data in a MAT file. When you load the file in MATLAB, you see the following structure:

Field	Value
start_time	'08-Jun-2016 01:11:28.400'
stop_time	'08-Jun-2016 01:17:31.100'
sampling_rate_in_Hz	10
samples_per_value	1
measurement	1x4 struct

The "logger" structure contains a substructure "measurement":

Fields	type	values	unit	total_min_value	total_min_value_time	total_max_value	total_max_value_time	total_avg_value	standard_deviation
1	'Power Factor(C1,C2)'	3610x1 single	[]	0	'08-Jun-2016 01:15:47.500'	0	'08-Jun-2016 01:15:47.900'	0.0394	0.0046
2	[]	[]	[]	0	'08-Jun-2016 01:11:28.400'	0	'08-Jun-2016 01:11:28.400'	0	0
3	[]	[]	[]	0	'08-Jun-2016 01:11:28.400'	0	'08-Jun-2016 01:11:28.400'	0	0
4	[]	[]	[]	0	'08-Jun-2016 01:11:28.400'	0	'08-Jun-2016 01:11:28.400'	0	0

The "measurement" structure contains the values:

	1	2	3	4	5	6
1	NaN					
2	NaN					
3	NaN					
4	NaN					
5	0.0397					
6	0.0397					
7	0.0397					
8	0.0397					
9	0.0396					
10	0.0396					
11	0.0396					
12	0.0396					
13	0.0398					
14	0.0398					
15	0.0398					
16	0.0398					
17	0.0398					
18	0.0398					
19	0.0398					

Required attributes are described in [Chapter 7.6.3, "Attributes in Exported Logger Records"](#), on page 159.

Except for MATLAB, the open source software "Octave" can also read the exported MAT files. "Octave" seeks for compatibility of commands with MATLAB.

7.6.2 Logger Records in CSV Files

Logger data is saved in two CSV files. One file contains the data values and is indicated by *Wfm.* in the file name. The second file contains the header data, which is required for data analysis.

Example:

```
logger.wfm.csv
logger.csv
```

`logger.wfm.csv` contains the recorded data values. `logger.csv` contains the header data, the attributes that are required to interpret the data values.

The header file lists the attribute names and values, one attribute per row.

```
RecordedSource:Scope:
ActiveLoggerChannels:1:
...
```

The header file lists many attributes but you need only some of them. In the following figure, required attributes are marked, and most of surplus attributes are hidden. Some attributes are given for each logger channel (measurement type, unit, statistical data). The attributes of a logger channel start with `ArrayItem: Index`.

1	LoggerAttributes:	
2	RecordedSource:Scope:	
3	ActiveLoggerChannels:1:	
4	VerticalRange:Medium:	
5	VerticalNotation:Auto:	
6	SampleRate:1 Sample/s:	
7	SampleRateAsNum:1:	
8	SamplesPerValue:1:	
9	StartTime:2016,09,08,15,58,01,0:	
10	StartTimeAsNum:1473343081000:	
11	StopTime:2016,09,08,15,58,42,0:	
32	LoggerChannel:	
33	ActiveIndex:0:	
34	ArrayItem:Index:0	Logger channel 1
35	Enabled:On:	
41	TimeOfMin:2016,09,08,15,58,12,0:	
42	Minimum:0.098108962178:	
44	TimeOfMax:2016,09,08,15,58,04,0:	
45	Maximum:0.099266834557:	
46	Average:0.098667144775:	
47	StdDeviation:0.000287987496:	
64	MeasUnitAsStr:V:	
68	MeasTypeAsStr:Amplitude(C1):	
80	ArrayItem:Index:1	Logger channel 2
81	Enabled:Off:	
82	...	

Required attributes are described in [Chapter 7.6.3, "Attributes in Exported Logger Records"](#), on page 159.

7.6.3 Attributes in Exported Logger Records

The following attributes are required to interpret the exported data values.

MATLAB	CSV	Description
	ActiveLoggerChannels	Number of logger channels that recorded data
start_time	StartTime	Absolute start time of the logger record
stop_time	StopTime	Absolute end time of the logger record
sampling_rate_in_Hz	SampleRate or SampleRateAsNum	Number of log samples per second

MATLAB	CSV	Description
samples_per_value	SamplesPerValue	Compression factor. If data logging is running for more than 2 days and 7 hours, the logger compresses subsequent logging values into a "Minimum", "Average" and "Maximum" value. <i>SamplesPerValue</i> = 4 means that four values are summarized.
measurement(m)	ArrayItem:Index	Logger channel (1, 2, 3, or 4) In CSV: <i>Logger channel = Index + 1</i>
	Enabled	Status of the logger channel: on or off
measurement(m).type	MeasTypeAsStr	Type of the logged measurement
measurement(m).unit	MeasUnitAsStr	Unit of the logged measurement
measurement(m).total_min_value	Minimum	Lowest value of the logged data
measurement(m).total_min_value_time	TimeOfMin	Time when the minimum was measured
measurement(m).total_max_value	Maximum	Highest value of the logged data
measurement(m).total_max_value_time	TimeOfMax	Time when the maximum was measured
measurement(m).total_avg_value	Average	Average value of the logged data
measurement(m).standard_deviation	StdDeviation	Standard deviation of the logged data

8 Protocol Analysis

Using the R&S RTH and additional options, you can analyze the following serial protocols:

- Serial Peripheral Interface (SPI) - requires option R&S RTH-K1
- Inter-Integrated circuit bus (I²C) - requires option R&S RTH-K1
- UART / RS-232 / RS-422 / RS-485 interfaces - require option R&S RTH-K2
- Controller Area Network (CAN) - requires option R&S RTH-K3
- Local Interconnect Network (LIN) - requires option R&S RTH-K3

The analysis of serial data consists of three main steps:

- Protocol configuration:
Select the protocol type, and configure the input line as well as the protocol-specific settings.
- Decoding:
Select the display format of the decoded data. The digitized signal data is displayed on the screen together with the decoded content of the messages in combs. You can scale the signal display and zoom into it to see it in more detail. You can also list the decoded results in tabular form in the "Protocol" mode.
- Triggering:
You can trigger on various events that are typical for the configured bus type, for example, on start and stop of messages, or on data patterns.

Analysis is performed on analog input channels. The instrument uses the threshold to convert the analog signal into a logic signal. If MSO option R&S RTH-B1 is installed, you can also analyze logic channels.

• Basics of Protocol Analysis	161
• I2C (Option R&S RTH-K1)	167
• SPI (Option R&S RTH-K1)	175
• UART/RS-232/RS-422/RS-485 (Option R&S RTH-K2)	181
• CAN (Option R&S RTH-K3)	187
• LIN (Option R&S RTH-K3)	196

8.1 Basics of Protocol Analysis

8.1.1 General Protocol Settings

Access: "Bus" menu

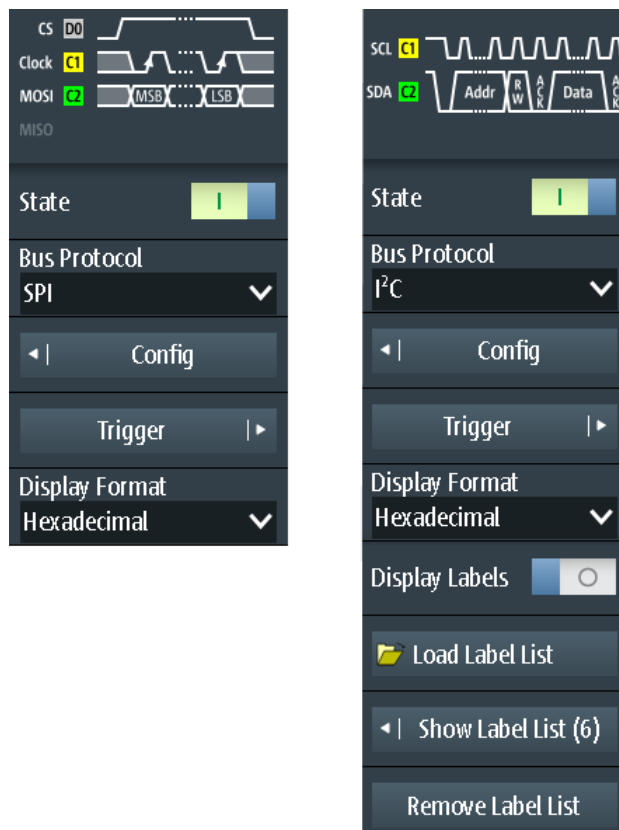

Figure 8-1: Bus menu. Left: for protocols without address (SPI, UART). Right: for protocols with address or identifier (I²C, CAN, LIN)

For all serial protocols, the following settings are required:

State

Enables the decoding and the display of the serial bus data.

Remote command:

[BUS\[:STATe\]](#) on page 375

Bus Protocol

Defines protocol type of the bus for configuration and trigger settings.

Remote command:

[BUS:TYPE](#) on page 374

Display Format

Sets the decoding format of the data: binary, hexadecimal, decimal, octal, or ASCII.

Remote command:

[BUS:FORMat](#) on page 375

Display Labels

Activates the last loaded label list and shows the label in the decoding results (comb display and protocol table).

Symbolic Decode ← Display Labels

Only available for CAN protocols if DBC file is loaded.

If disabled, only the message names are shown in the comb display of the decoded data. If enabled, the signal labels are shown in addition.

Load Label List

Selects and loads a label list file.

Label lists are protocol-specific. Their contents are described in the corresponding protocol chapters:

- [Chapter 8.2.4, "I²C Label List"](#), on page 172
- [Chapter 8.5.3, "CAN Label List"](#), on page 192
- [Chapter 8.6.4, "LIN Label List"](#), on page 201

Show Label List

Shows the content of the label list file in a window.

Remove Label List

Disables the loaded label list.

8.1.2 Decode Results

When the configuration of the serial bus is complete, the instrument can decode the signal. The decode results are displayed in two ways:

- Bus signal with combs, time-correlated to the input signals. The combs show the values of the frames or words.
- Decode results table. The table provides data values and time information of the frames or words.

To decode the serial bus

1. In the "Bus" menu, enable "State".

The bus signal with combs is shown. The colors of the combs are protocol-specific and described in the "Decode Results" chapters of the protocol description.



Figure 8-2: Comb display of a decoded CAN signal

2. To show the decode results in a table, do the following:
 - a) Press the MODE key.
 - b) Select the "Protocol" mode.

The result table is shown. The contents is protocol-specific and described in the "Decode Results" chapters of the protocol description.

To adjust the scaling of the decoded bus signal in scope mode

1. The horizontal size of the combs is defined by the horizontal time scale, which is the same for input signals and the bus signal. Press the TIME keys to change the time scale.
2. The vertical size is specific for the bus signal.
 - a) Tap the bus signal to set the focus to it.
 - b) Press the RANGE keys.

Protocol mode

In "Protocol" mode, you see the results table and the small signals below. Each table row contains the information of one frame.

All menus that are relevant for protocol analysis are available, in particular, the "Bus" and "Trigger" menus. Thus, you can adjust the settings without changing the mode.

Sometimes the row is too short to show the all frame information. To show the complete information, tap the row. A window with values and time data of the selected row opens.

8.1.3 Label Lists

For all protocols using ID or address identification, it is possible to create label lists containing addresses or IDs, a symbolic name for each node (symbolic label), and some protocol-specific information.

You can load label lists, and activate its usage for decoding. As a result, an additional "Label" column appears in the "Decode results" table, containing the symbolic label. The frame captions of the decoded signal show the symbolic label instead of the ID or address values so it is easy to identify the messages of the different bus nodes.

You can also use the label list to trigger on an identifier or address. Instead of entering the value, you select the identifier on the label list.

Available file formats are PTT, CSV, and DBC (CAN only).

Label lists are protocol-specific. Their contents are described in the corresponding protocol chapters:

- [Chapter 8.2.4, "I²C Label List"](#), on page 172
- [Chapter 8.5.3, "CAN Label List"](#), on page 192
- [Chapter 8.6.4, "LIN Label List"](#), on page 201

8.1.3.1 Using Label Lists

To load a label list and display the labels:

1. Save the label list file on a USB flash drive, or on the microSD card.
2. Press and hold the BUS key until the menu opens.

3. Configure the protocol.
4. In the "Bus" menu, tap "Load Label List".
5. Navigate to the label list file, select it, and tap "Select".
6. To read the label list, tap "Show Label List".
7. To use the labels in the display of the decoded data, tap "Display Labels".

To trigger on an identifier or address using the label:

Prerequisites: The bus is configured, decoding is enabled, and a decoded signal is visible.

1. Open the "Trigger" menu.
2. Set the following trigger settings:
 - "Trigger Mode" = "Normal"
 - "Trigger Type" = "Bus"
 - "<Protocol> Trigger" = "Identifier", or "Identifier + Data", or "Address", or "Address and Data".
3. Tap "Identifier from Label" or "Address from Label".
4. Select the label. Tap "Back".

If the selected identifier or address is available in the acquired data, its value is shown in the menu, and the instrument triggers on it.

8.1.3.2 Content and Format of the PTT File

Label lists are stored as PTT (protocol translation table) files. The PTT file format is an extension of the CSV format (comma-separated values). You can edit it with standard editors, for example, with MS Excel or a text editor.

The PTT file has three types of lines:

- Comment lines begin with a hash character #. A hash character at any other position in the line is treated like a standard character.
- Command lines begin with a commercial at character @. An @ character at any other position in the line is treated like a standard character.
- Standard lines are the lines that not qualify as comment or command lines. They build the core of the label list.

Command lines

Command lines define the version of the PTT file and the protocol name:

- @FILE_VERSION: must appear exactly once in the file
- @PROTOCOL_NAME: must appear at least once in the file. Thus, one file can contain several label lists for different protocols.

```
# --- Start of PTT file
@FILE_VERSION = 1.0
```



```
@PROTOCOL_NAME = i2c
[... Label list for I2C]
@PROTOCOL_NAME = can
[... Label list for CAN]
# --- End of PTT file
```

Standard lines

Standard lines define the contents of the label list. The rules for standard lines follow the csv convention, they are:

- Values are separated by commas
- Space characters following a delimiter are ignored
- Values with a special character (comma, newline, or double quote) must be enclosed in double quotes
- Text in double quotes must be escaped by double quote characters

The format of the numeric value is indicated by a suffix. The following formats are supported:

Format	Suffix	Example
Decimal	<empty> d	106, DeviceName 106d, DeviceName
Hexadecimal	h	6Ah, DeviceName or prefix: 0x6A, DeviceName
Octal	o	152o, DeviceName
Binary	b	01101010b, DeviceName

The maximum supported word size for (unsigned) integers is 64 bits.

```
# --- Start of PTT file
@FILE_VERSION = 1.0
@PROTOCOL_NAME = i2c
#   Following two lines are equal:
7,01h, Temperature
7,01h, Temperature
#   A comma must be enclosed in double quotes:
7,01h, "Temperature, Pressure, and Volume"
#   A double quote must also be enclosed in double quotes:
7,7Fh, "Highspeed ""Master"" 01"
#   Following lines yield the same result:
7d,0x11, Pressure
7h,11h, Pressure
0x7,17d, Pressure
7,17, Pressure
```

8.2 I2C (Option R&S RTH-K1)

8.2.1 The I²C Protocol

This chapter provides an overview of protocol characteristics, data format, address types and trigger possibilities. For detailed information, read the "I2C-bus specification and user manual" available on the NXP manuals web page at <http://www.nxp.com/>.

I²C characteristics

Main characteristics of I²C are:

- Two-wire design: serial clock (SCL) and serial data (SDA) lines
- Master-slave communication: the master generates the clock and addresses the slaves. Slaves receive the address and the clock. Both master and slaves can transmit and receive data.
- Addressing scheme: each slave device is addressable by a unique address. Multiple slave devices can be linked together and can be addressed by the same master.
- Read/write bit: specifies if the master will read (=1) or write (=0) the data.
- Acknowledge: takes place after every byte. The receiver of the address or data sends the acknowledge bit to the transmitter.

The R&S RTH supports all operating speed modes: high-speed, fast mode plus, fast mode, and standard mode.

Data transfer

The format of a simple I²C message (frame) with 7 bit addressing consists of the following parts:

- Start condition: a falling slope on SDA while SCL is high
- 7-bit address of the slave device that either will be written to or read from
- R/W bit: specifies if the data will be written to or read from the slave
- ACKnowledge bits: is issued by the receiver of the previous byte if the transfer was successful
Exception: At read access, the master terminates the data transmission with a NACK bit after the last byte.
- Data: a number of data bytes with an ACK bit after every byte
- Stop condition: a rising slope on SDA while SCL is high

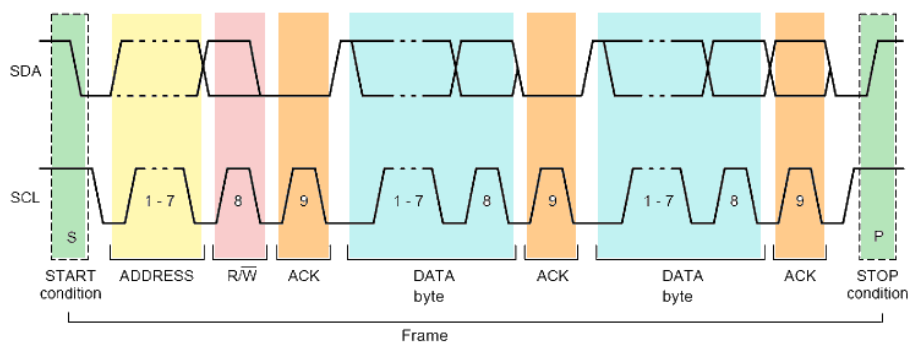

Figure 8-3: I2C write access with 7-bit address

Address types: 7-bit and 10-bit

Slave addresses can be 7 or 10 bits long. A 7-bit address requires one byte, 7 bits for the address followed by the R/W bit.

A 10-bit address for write access requires two bytes: the first byte starts with the reserved sequence 11110, followed by the two MSB of the address and the write bit. The second byte contains the remaining 8 LSB of the address. The slave acknowledges each address byte.

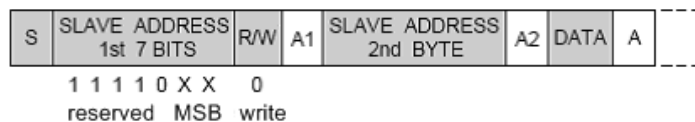

Figure 8-4: 10-bit address, write access

A 10-bit address for read access requires three bytes. The first two bytes are identical to the write access address. The third byte repeats the address bits of the first byte and sets the read bit.

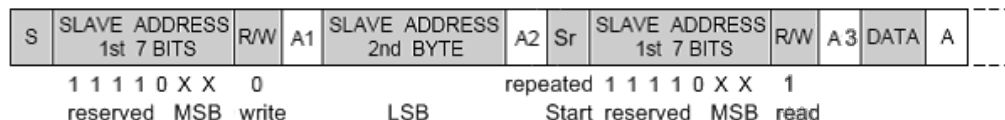

Figure 8-5: 10-bit address, read access

Trigger

The R&S RTH can trigger on various parts of I²C messages. The data and clock lines must be connected to the input channels, triggering on math and reference waveforms is not possible.

You can trigger on:

- Start or stop condition
- Repeated start condition
- Transfer direction (read or write)
- Bytes with missing acknowledge bit

- Specific slave address
- Specific data pattern in the message

8.2.2 I2C Configuration Settings

Access: "Bus" menu > "Bus Protocol" = "I2C" > "Config"

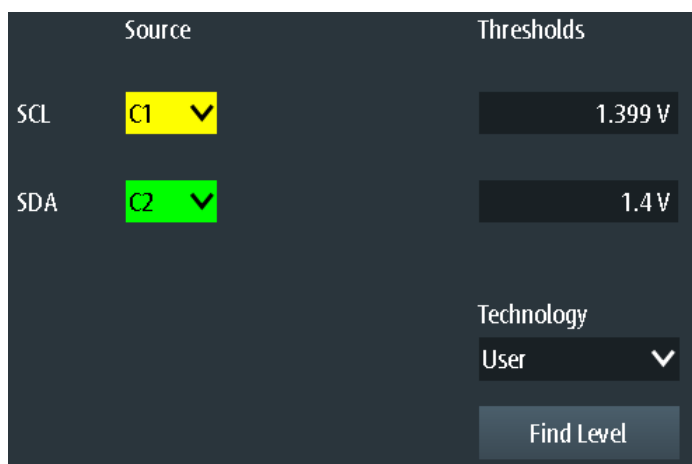

SCL, SDA

Set the input source of the data line (SDA) and clock line (SCL).

If option R&S RTH-B1 is installed, digital channels can also be used as source.

Remote command:

[BUS:I2C:SCL:SOURce](#) on page 375

[BUS:I2C:SDA:SOURce](#) on page 375

Thresholds, Technology, Find Level

Sets the threshold value for digitization of signals. If the signal value is higher than the threshold, the signal state is high. Otherwise, the signal state is considered low.

You can select the threshold voltages for various types of integrated circuits in the "Technology" list, or set a user-defined value in "Thresholds". You can also let the instrument set the appropriate threshold using "Find Level".

Changing the thresholds in the bus configuration changes also the thresholds of analog channels in the "Vertical" menu, or the thresholds of logic channels in the "Logic" menu.

Remote command:

[BUS:I2C:TECHnology](#) on page 376

[BUS:I2C:SCL:THReshold](#) on page 376

[BUS:I2C:SDA:THReshold](#) on page 376

[BUS:SETRefllevels](#) on page 376

[CHANnel<m>:THReshold:FINDlevel](#) on page 257

8.2.3 I2C Trigger Settings

Access: "Bus" menu > "Bus Protocol" = "I2C" > "Trigger"



I2C Trigger

Selects the trigger type for I²C analysis.

- "Start" Sets the trigger to the start of the message. The start condition is a falling edge on SDA while SCL is high. The trigger instant is the falling edge of the SDA line.
- "Restart" Sets the trigger to a restart - when the start condition occurs without previous stop condition. Restart conditions occur when a master exchanges multiple messages with a slave without releasing the bus.
- "Stop" Sets the trigger to the end of the message. The stop condition is a rising slope on SDA while SCL is high.
- "No Ack (Missing Ack)"
Missing acknowledge bit: the instrument triggers if the data line remains HIGH during the clock pulse following a transmitted byte. You can also localize specific missing acknowledge bits by setting the [No Ack \(Missing Ack\)](#) bits.
- "Address" Sets the trigger to one specific address pattern that is expected. The trigger time is the falling clock edge of the acknowledge bit after the address.
- "Data" Sets the trigger to a specified data pattern that is expected.
- "Address and Data" Sets the trigger to a combination of address and data condition.

Remote command:

[TRIGger:I2C:MODE](#) on page 377

No Ack (Missing Ack)

Selects which missing acknowledge bits is detected if the trigger type is set to "No Ack (Missing Ack)".

"Address NACK"

No slave recognizes the address.

"Data Read NACK"

Marks the end of the read process when the master reads data from the slave. This Nack is sent according to the protocol definition, it is not an error.

"Data Write NACK"

The addressed slave does not accept the written data.

Remote command:

[TRIGger:I2C:ADNack](#) on page 377

[TRIGger:I2C:DRNack](#) on page 377

[TRIGger:I2C:DWNack](#) on page 377

Address Pattern

Specifies the address pattern to be found, in binary or hex format. Enter the pattern in MSB first bit order.

See also [Chapter 2.5.12.1, "Pattern Definition"](#), on page 66.

Remote command:

[TRIGger:I2C:ADDRess](#) on page 378

Address Relation

Defines how the specified serial address pattern is compared with the acquired signal. The instrument triggers if the acquired address is equal or unequal the defined pattern.

Remote command:

[TRIGger:I2C:ACONdition](#) on page 378

R/W Bit

Toggles the trigger condition between read and write access of the master. Select "Either" if the transfer direction is not relevant for the trigger condition.

Remote command:

[TRIGger:I2C:ACCess](#) on page 377

Data Pattern

Specifies the data pattern to be found on the specified line, in binary or hex format. Enter the words in MSB first bit order.

See also [Chapter 2.5.12.1, "Pattern Definition"](#), on page 66.

Remote command:

[TRIGger:I2C:DATA](#) on page 378

Data Relation

Sets how the defined serial data pattern is compared with the acquired signal. The instrument triggers if the acquired data pattern is equal or unequal the defined pattern.

Remote command:

[TRIGger:I2C:DCondition](#) on page 378

Byte Offset

Sets the number of bytes before the first byte of the data pattern. These bytes are ignored.

Remote command:

[TRIGger:I2C:DPosition](#) on page 379

8.2.4 I²C Label List

Label lists are protocol-specific. Label lists for I²C are available in CSV and PTT format.

An I²C label file contains three values for each address:

- Address type, 7-bit or 10-bit long
- Address value
- Symbolic label: name of the address, specifying its function in the bus network.

Example: I²C PTT file

```
# -----
@FILE_VERSION = 1.00
@PROTOCOL_NAME = i2c
# -----
# Labels for I2C protocol
# Column order: Identifier type, Identifier value, Label
# -----
7,0x1E,Voltage
7,38h,Pressure
7,2Ah,Temperature
7,16h,Speed
7,118,Acceleration
7,07h,HighSpeed_Master_0x3
7,51h,EEPROM
10,3A2h,DeviceSetup
10,1A3h,GatewayStatus
10,06Eh,LeftSensor
# -----
```

For general information on label lists, see [Chapter 8.1.3, "Label Lists"](#), on page 164.

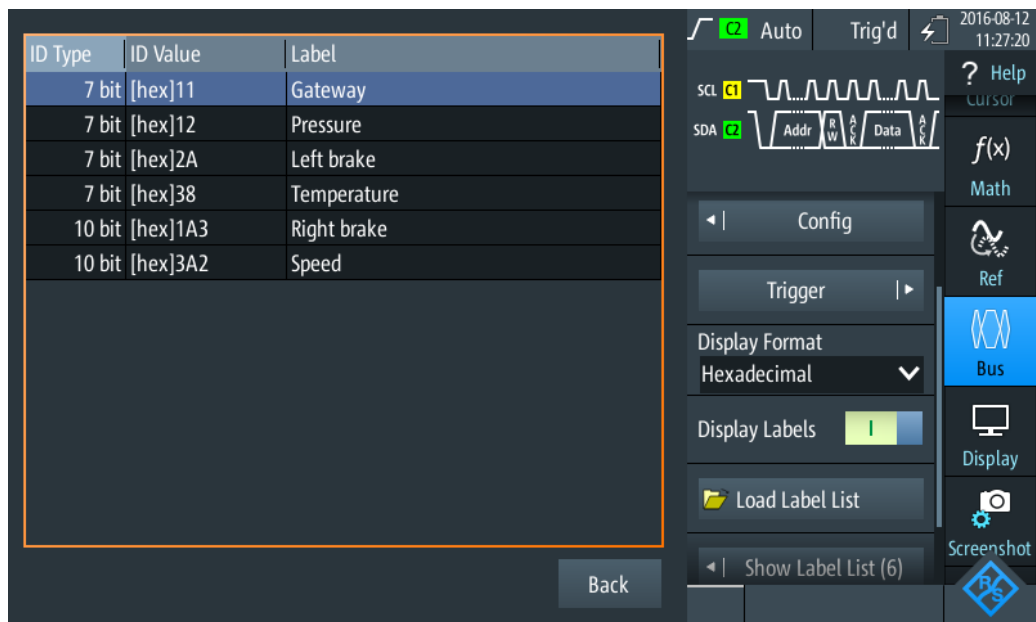

Figure 8-6: Display of an I2C label list

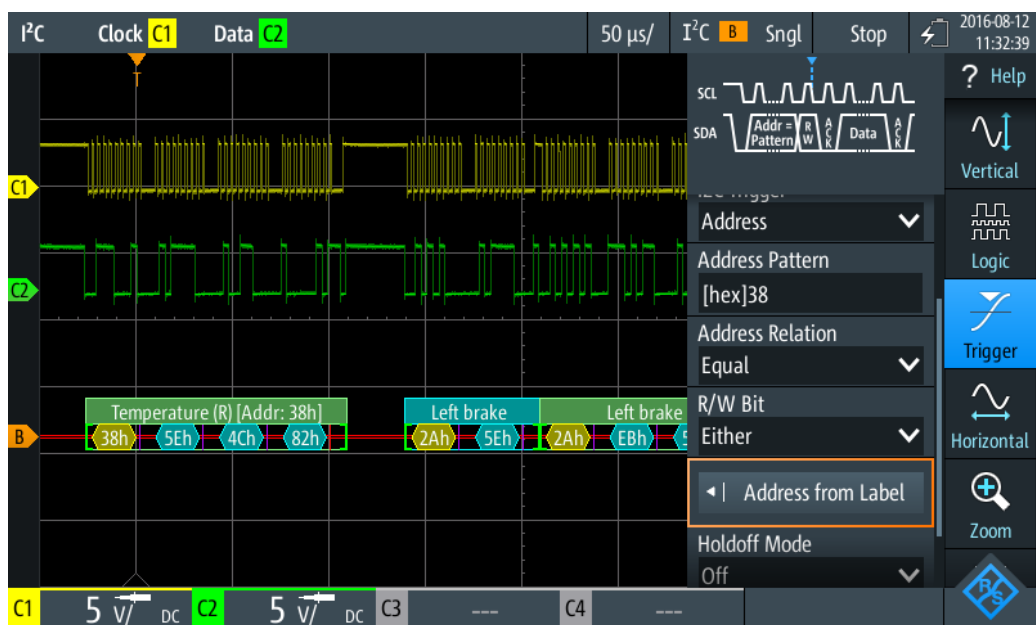

Figure 8-7: Trigger on address "Temperature", value 38 (hex)

8.2.5 I2C Decode Results

This chapter describes the comb display and the decode results table of decoded I2C buses. Basic information on decoding and display of decode results is given in [Chapter 8.1.2, "Decode Results"](#), on page 163.

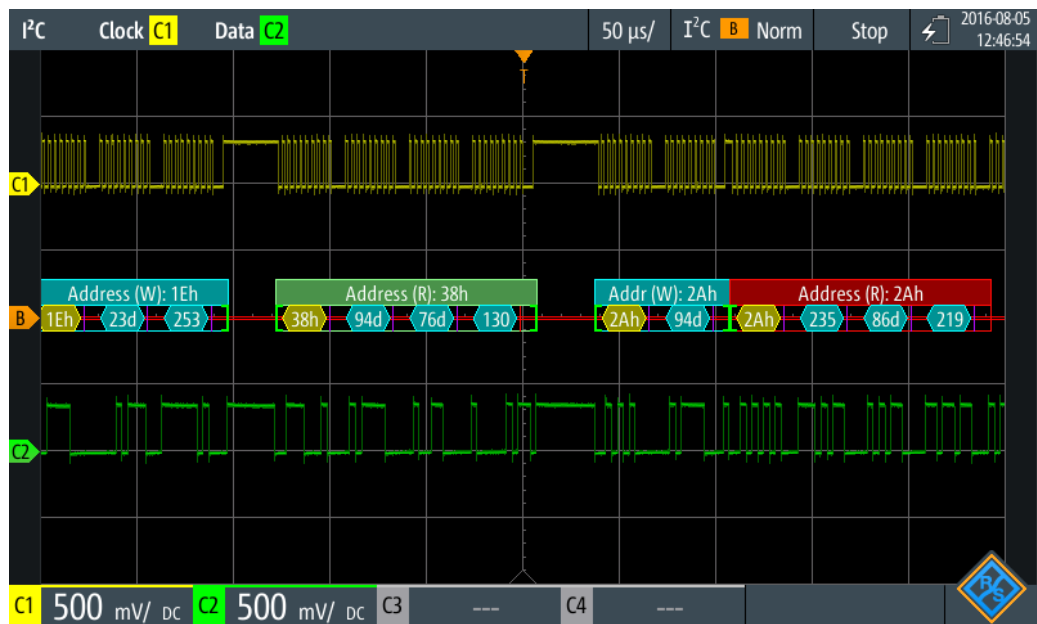

Figure 8-8: Comb display of a decoded I²C signal, triggered on a missing acknowledge bit

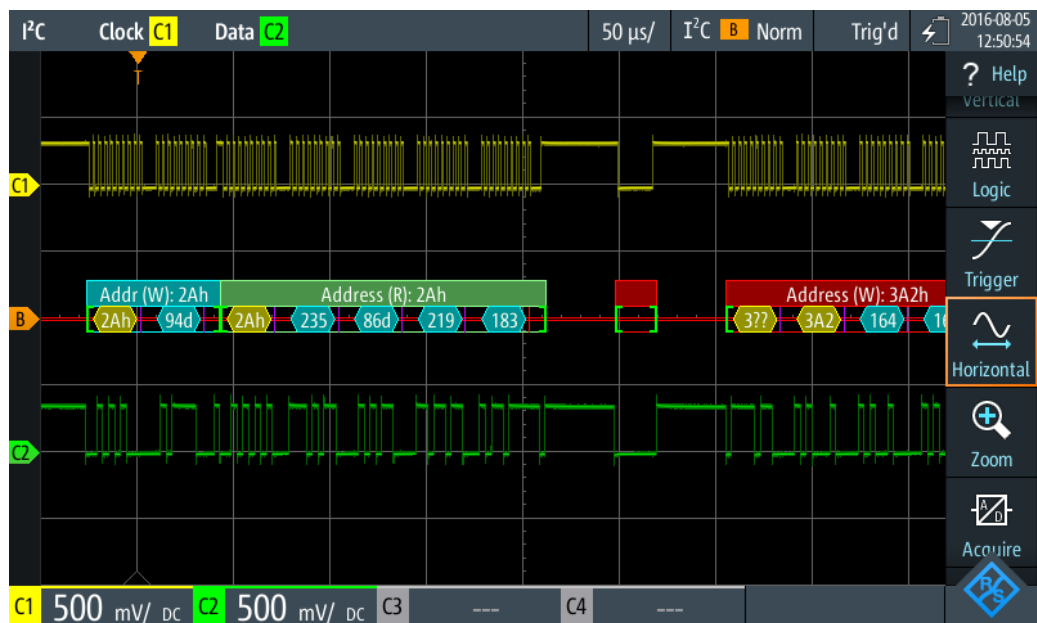

Figure 8-9: Comb display of a decoded I²C signal, triggered on address 2A (hex)

The color-coding of the various protocol sections and errors simplifies the interpretation of the visual display.

Table 8-1: Color codes of decoded I²C signals

Color, display element	Description
Green brackets [...]	Start and end of frame
Green frame header	Read frame. Text indicates transfer direction (R = read) and address of the frame (hex)

Color, display element	Description
Cyan frame header	Write frame. Text indicates transfer direction (W = write) and address of the frame (hex)
Yellow comb	Address
Cyan comb	Data bytes
Violet	Acknowledge bit
Red	Missing acknowledge bit, error in frame, insufficient frame (end of acquisition before decoding has been completed)

In "Protocol" mode, decoded data is shown in tabular form.

Table 8-2: Content of the protocol table for decoded I²C signal

Column	Description
#	Frame index
Frame Start	Time of frame start
Address [hex]	Hexadecimal value of the address
Address R/W	Value of the R/W bit
Values 8 bit [format]	Value of data byte. The data format is selected in the "Bus" menu.
State	Overall state of the frame. "Incomplete" indicates that the frame is not completely contained in the acquisition. Change the time scale to get a longer acquisition.

Remote commands are described in [Chapter 14.11.2.3, "I2C Decode Results"](#), on page 379.

8.3 SPI (Option R&S RTH-K1)

8.3.1 The SPI Protocol

A 4-channel instrument is required for full support of the SPI protocol.

The Serial Peripheral Interface SPI is used for communication with slow peripheral devices, in particular, for transmission of data streams.

Main characteristics of SPI are:

- Master-slave communication
- No device addressing; The slave is accessed by a chip select, or slave select line.
- No acknowledgement mechanism to confirm receipt of data
- Duplex capability

Most SPI buses have four lines, two data and two control lines:

- Clock line to all slaves (SCLK)
- Slave Select or Chip Select line (SS or CS)
- Master data output, slave data input (MOSI or SDI)
- Master data input, slave data output (MISO or SDO)

When the master generates a clock and selects a slave device, data may be transferred in either or both directions simultaneously.

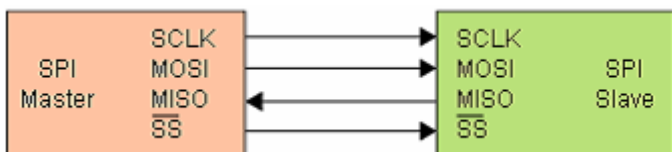

Figure 8-10: Simple configuration of SPI bus

The data bits of a message are grouped by following criteria:

- A word contains a number of successive bits. The word length is defined in the protocol configuration.
- A frame contains a number of successive words, at least one word.

For SPI buses, the R&S RTH provides the following trigger possibilities:

- On frame start
- On frame end
- On a serial pattern at a specified position

8.3.2 SPI Configuration Settings

Access: "Bus" menu > "Bus Protocol" = "SPI" > "Config"

	Source	Polarity	Thresholds
CS	None	Active high	1.4 V
		Slope	
Clock	C1	Rising	1.399 V
MOSI	C2		1.4 V
MISO	None		1.4 V
Word Length	8 bit	Bit Order	Technology
		MSB First	User
Frame Timeout	1 ms		Find Level

Source: CS, Clock, MOSI, MISO

Set the input channels of the SPI lines.

If option R&S RTH-B1 is installed, digital channels can also be used as source.

Remote command:

[BUS:SPI:SSEL:SOURce](#) on page 386

[BUS:SPI:SCLK:SOURce](#) on page 386

[BUS:SPI:MISO:SOURce](#) on page 386

[BUS:SPI:MOSI:SOURce](#) on page 386

Polarity

Selects whether the chip select signal is high active (high = 1) or low active (low = 1).

Remote command:

[BUS:SPI:SSEL:POLarity](#) on page 386

Slope

Selects if data are sampled on the rising or falling slope of the clock. The clock slope marks the begin of a new bit.

Remote command:

[BUS:SPI:SCLK:SLOPe](#) on page 386

Thresholds, Technology, Find Level

Sets the threshold value for digitization of signals. If the signal value is higher than the threshold, the signal state is high. Otherwise, the signal state is considered low.

You can select the threshold voltage on all lines for various types of integrated circuits in the "Technology" list, or set a user-defined value for each line in "Thresholds". You can also let the instrument set the appropriate thresholds using "Find Level".

Changing the thresholds in the bus configuration changes also the thresholds of analog channels in the "Vertical" menu, or the thresholds of logic channels in the "Logic" menu.

Remote command:

[BUS:SPI:TECHnology](#) on page 386

[BUS:SPI:SSEL:THReshold](#) on page 387

[BUS:SPI:SCLK:THReshold](#) on page 387

[BUS:SPI:MISO:THReshold](#) on page 387

[BUS:SPI:MOSI:THReshold](#) on page 387

[BUS:SETReflevels](#) on page 376

[CHANnel<m>:THReshold:FINDlevel](#) on page 257

Word Length

Sets the number of bits in a word. The maximum length is 32 bit.

Remote command:

[BUS:SPI:WSIZe](#) on page 387

Bit Order

Defines if the data of the words starts with MSB (most significant bit) or LSB (least significant bit). The display of the decoded signal considers this setting, results are displayed in the specified order.

Remote command:

[BUS:SPI:ORDeR](#) on page 387

Frame Timeout

Sets the minimum idle time between two data frames. If the time interval between the data frames is shorter, the words are part of the same frame. Within the timeout, the data and clock lines are low. A new frame begins when the timeout has expired.

Timeout is only relevant if the bus has no chip select.

Remote command:

[BUS:SPI:TIMEout](#) on page 388

8.3.3 SPI Trigger Settings

Access: "Bus" menu > "Bus Protocol" = "SPI" > "Trigger"



SPI Trigger

Selects the trigger type for SPI analysis.

- "Frame Start" Sets the trigger to the start of the message. If the bus has a CS line, the frame starts when the chip select signal changes to the active state. Without CS line, the frame starts when the idle time has expired.
- "Frame End" Sets the trigger to the end of the message. If the bus has a CS line, the frame ends when the chip select signal changes to the inactive state. Without CS line, the frame ends when the idle time has expired after the last clock and no new clock appeared during that time.

"Data" Sets the trigger to a specified bit pattern that is expected on one of the lines.

Remote command:

[TRIGger:SPI:MODE](#) on page 388

Datasource

Selects the line, on which the trigger pattern is expected.

Remote command:

[TRIGger:SPI:DSRC](#) on page 389

Pattern

Specifies the data pattern to be found on the specified line, in binary or hex format. Enter the words in MSB first bit order.

See also [Chapter 2.5.12.1, "Pattern Definition"](#), on page 66.

Remote command:

[TRIGger:SPI:DATA](#) on page 389

Relation

Defines how the defined serial data pattern is compared with the acquired signal. The instrument triggers if the acquired data word is equal or unequal the defined pattern.

Remote command:

[TRIGger:SPI:DCondition](#) on page 389

Bit Offset

Sets the number of bits before the first bit of the pattern. These bits are ignored. The first bit after CS or timeout is bit 0. For example, with bit offset = 2, bit 0 and bit 1 after CS are ignored, and the pattern starts with bit 2.

Remote command:

[TRIGger:SPI:DPosition](#) on page 389

Chip Select

Defines if the SPI bus uses a chip select line or not.

Remote command:

[BUS:SPI:SSEL:STATe](#) on page 388

8.3.4 SPI Decode Results

This chapter describes the comb display and the decode results table of decoded SPI buses. Basic information on decoding and display of decode results is given in [Chapter 8.1.2, "Decode Results"](#), on page 163.

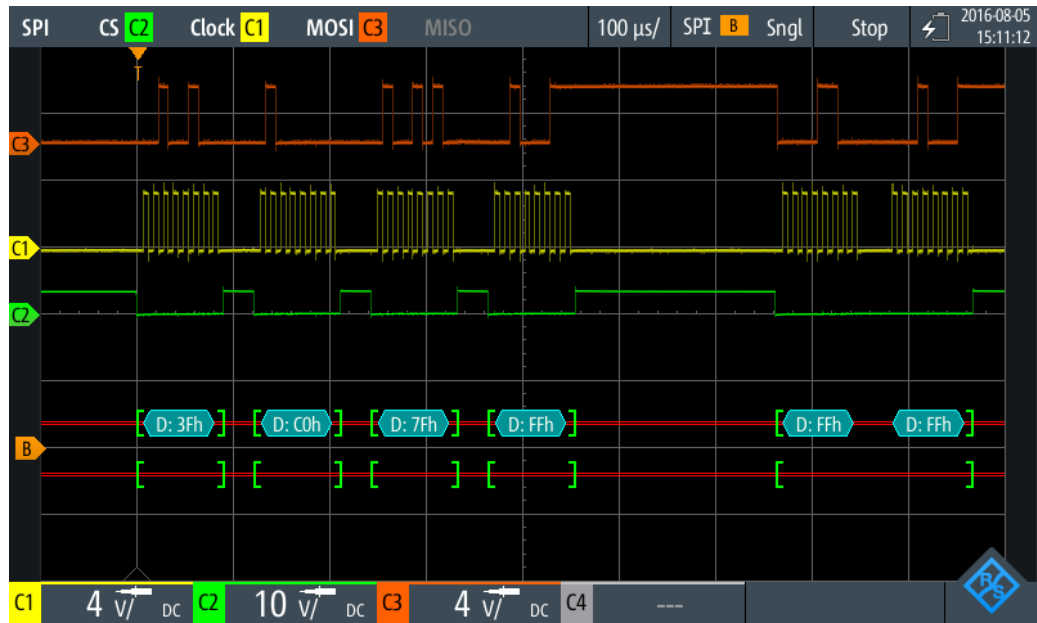

Figure 8-11: Comb display of a decoded SPI signal, triggered on frame start

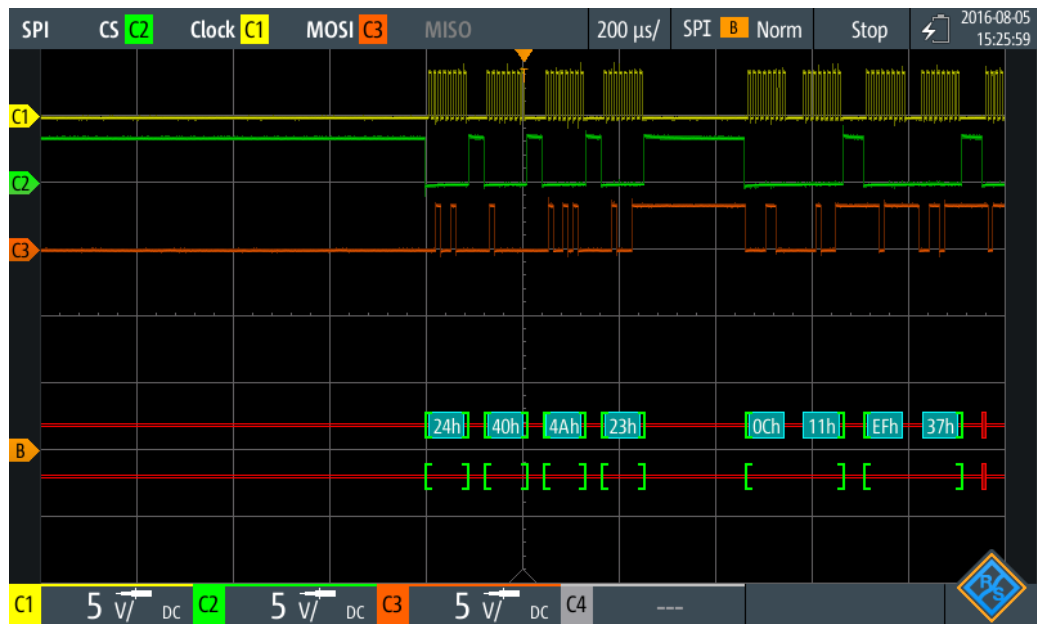

Figure 8-12: Comb display of a decoded SPI signal, triggered on data pattern 40 (hex)

The color-coding of the various protocol sections and errors simplifies the interpretation of the visual display.

Table 8-3: Color codes of decoded SPI signals

Color, display element	Description
Green brackets [...]	Start and end of frame
Cyan comb	Data words
Red	Error, or insufficient frame (end of acquisition before decoding has been completed)

In "Protocol" mode, decoded data is shown in tabular form.

Table 8-4: Content of the protocol table for decoded SPI signal

Column	Description
#	Frame index
Frame Start	Time of frame start
MOSI <x> bit [format]	Value of the MOSI data word. The data format is selected in the "Bus" menu. The column header indicates the selected word length.
MISO <x> bit [format]	Value of the MISO data word. The data format is selected in the "Bus" menu. The column header indicates the selected word length.
State	Overall state of the frame. "Incomplete" indicates that the frame is not completely contained in the acquisition. Change the time scale to get a longer acquisition.

Remote commands are described in [Chapter 14.11.3.3, "SPI Decode Results"](#), on page 389.

8.4 UART/RS-232/RS-422/RS-485 (Option R&S RTH-K2)

8.4.1 UART Interface

The Universal Asynchronous Receiver/Transmitter UART converts words of data into serial data, and vice versa. It is the base of many serial protocols like of RS-232 and RS-422. The UART uses only one line, or two lines for transmitter and receiver. The R&S RTH can analyze one UART line.

Data transfer

The data is transmitted in words, also referred to as symbols or characters. Each word consists of a start bit, several data bits, an optional parity bit, and one or more stop bits. Several words can form a frame, or package. The end of a frame is marked by a pause between two symbols.

**Figure 8-13: Bit order in a UART word (symbol)**

- The start bit is a logic 0.
- The stop bits and the idle state are always logic 1.

The UART protocol has no clock for synchronization. The receiver synchronizes by means of the start and stop bits, and the bit rate that must be known to the receiver.

Trigger

The R&S RTH can trigger on specified parts of UART serial signals:

- Start bit of a word
- Frame start
- Data pattern
- Parity error
- Stop error
- Break

8.4.2 UART Configuration Settings

Access: "Bus" menu > "Bus Protocol" = "UART" > "Config"

Source	C1	Polarity	Idle High	Threshold	1.399 V
Bit Rate	14.4 kbps	Predefined Bit Rates	14.4 kbps	Technology	User
Data Bits	8 bit	Parity	None	Find Level	
Bit Order	MSB First	Frame Mode	None	Stop Bits	1 bit
				Idle Time	1 ms

Source

Selects the input channel to which the UART line is connected.

If option R&S RTH-B1 is installed, digital channels can also be used as source.

Remote command:

[BUS : UART : SOURce](#) on page 393

Polarity

Defines the logic states of the line. In idle high state, the idle state corresponds to a logic 1, and the start bit to a logic 0. In idle low state, the idle state corresponds to a logic 0, and the start bit to a logic 1. During idle time, no data is transmitted.

Remote command:

[BUS:UART:POLarity](#) on page 394

Threshold, Technology, Find Level

Sets the threshold value for digitization of signals. If the signal value is higher than the threshold, the signal state is high. Otherwise, the signal state is considered low. The interpretation of high and low is defined by the [Polarity](#).

You can select the threshold voltages for various types of integrated circuits in the "Technology" list, or set a user-defined value in "Threshold". You can also let the instrument set the appropriate threshold using "Find Level".

Changing the thresholds in the bus configuration changes also the thresholds of analog channels in the "Vertical" menu, or the thresholds of logic channels in the "Logic" menu.

Remote command:

[BUS:UART:TECHnology](#) on page 394

[BUS:UART:THReshold](#) on page 394

[BUS:SETRefllevels](#) on page 376

[CHANnel<m>:THReshold:FINDlevel](#) on page 257

Predefined Bit Rates, Bit Rate

Set the number of transmitted bits per second.

You can select a predefined value in the "Predefined Bit Rates" list, or set a user-defined value in "Bit Rate".

Remote command:

[BUS:UART:STDBitrate](#) on page 394

[BUS:UART:BITRate](#) on page 395

Data Bits

Sets the number of data bits in a word (symbol) in a range from 5 bits to 9 bits.

Remote command:

[BUS:UART:SSIZe](#) on page 395

Parity

Defines the optional parity bit that is used for error detection.

"None" No parity bit is used.

"Odd" The parity bit is set to "1" if the number of data bits set to "1" is even.

"Even" The parity bit is set to "1" if the number of data bits set to "1" is odd.

Remote command:

[BUS:UART:PARity](#) on page 395

Stop Bits

Sets the number of stop bits: 1 or 1.5 or 2 stop bits are possible.

Remote command:

[BUS:UART:SBIT](#) on page 395

Bit Order

Defines if a word starts with MSB (most significant bit) or LSB (least significant bit). The display of the decoded signal considers this setting, results are displayed in the specified order.

Remote command:

[BUS:UART:ORDER](#) on page 396

Frame Mode

Allows you to decode frames of several words in the data stream, which are defined by a timeout between a stop bit and the next start bit. Enter the minimum timeout between two frames in "Idle Time".

Remote command:

[BUS:UART:FRAMEmode](#) on page 396

[BUS:UART:TOUT](#) on page 396

8.4.3 UART Trigger Settings

Access: "Bus" menu > "Bus Protocol" = "UART" > "Trigger"

UART Trigger

Selects the trigger type for UART analysis.

"Start Bit"	Triggers on a start bit. The start bit is the first low bit after a stop bit if polarity is idle high.
"Frame Start"	Triggers on the begin of a data frame. The frame start is configured with BUS:UART:FRAMEmode .
"Data"	Triggers on a serial pattern or data word. You can define the Pattern and Relation .
"Parity Error"	Triggers on a parity error, which indicates a transmission error. This trigger type is only available if a parity is configured for the UART bus.
"Stop Error"	Triggers if the stop bit is a logic 0.
"Break Condition"	Triggers if a start bit is not followed by a stop bit, and the data line remains at logic 0 for longer than a UART word.

Remote command:

[TRIGger:UART:TYPE](#) on page 396

Pattern

Specifies the data pattern to be found on the specified trigger source, in binary or hex format. Enter the words in MSB first bit order.

See also [Chapter 2.5.12.1, "Pattern Definition"](#), on page 66.

Remote command:

[TRIGger:UART:DATA](#) on page 397

Relation

Defines how the defined serial data pattern is compared with the acquired signal. The instrument triggers if the acquired data word is equal or unequal the defined pattern.

Remote command:

[TRIGGER:UART:DCondition](#) on page 397

8.4.4 UART Decode Results

This chapter describes the comb display and the decode results table of decoded UART buses. Basic information on decoding and display of decode results is given in [Chapter 8.1.2, "Decode Results"](#), on page 163.

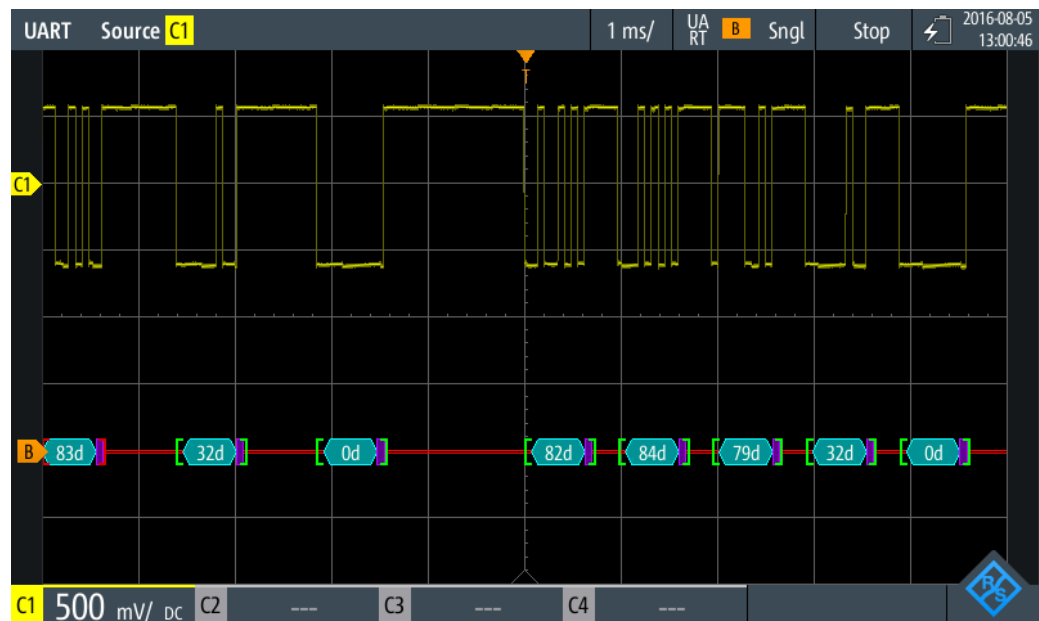

Figure 8-14: Comb display of a decoded UART signal, triggered on start bit

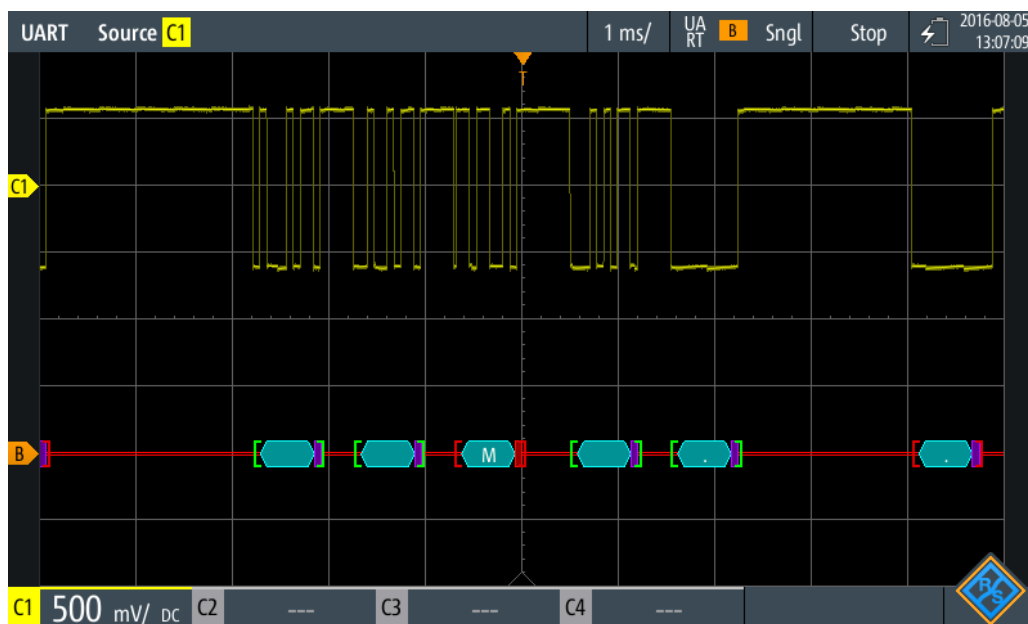

Figure 8-15: Comb display of a decoded UART signal, triggered on parity error

The color-coding of the various protocol sections and errors simplifies the interpretation of the visual display.

Table 8-5: Color codes of decoded UART signals

Color, display element	Description
Green brackets [...]	Start and end of frame
Cyan comb	Data words
Violet comb	Parity bit
Red	Start error, stop error, parity error, or insufficient frame (end of acquisition before decoding has been completed)

In "Protocol" mode, decoded data is shown in tabular form.

Table 8-6: Content of the protocol table for decoded UART signal

Column	Description
#	Frame index
Frame Start	Time of frame start
Value <x> bit [format]	Value of the data word. The data format is selected in the "Bus" menu. The column header indicates the selected word length.
State	Overall state of the frame. "Incomplete" indicates that the frame is not completely contained in the acquisition. Change the time scale to get a longer acquisition.

Remote commands are described in [Chapter 14.11.4.3, "UART Decode Results"](#), on page 397.

8.5 CAN (Option R&S RTH-K3)

CAN is the Controller Area Network, a bus system used within automotive network architecture.

8.5.1 CAN Configuration Settings

Access: "Bus" menu > "Bus Protocol" = "CAN" > "Config"

The screenshot shows the CAN Configuration Settings menu. The settings are as follows:

- Source: C1
- Polarity: CAN_L
- Threshold: 1.399 V
- Technology: User
- Bit Rate: 50 kbps
- Predefined Bit Rates: 50 kbps
- Sample Point: 50 %

A "Find Level" button is located below the Technology dropdown.

Source

Sets the input channel of the CAN line. All active analog channels can be used. If option R&S RTH-B1 is installed, digital channels can also be used as source.

Remote command:

[BUS:CAN:DATA:SOURce](#) on page 399

Polarity

Selects whether the chip select signal is high active (high = 1) or low active (low = 1).

Remote command:

[BUS:CAN:TYPE](#) on page 400

Threshold, Technology, Find Level

Sets the threshold value for digitization of signals. If the signal value is higher than the threshold, the signal state is high. Otherwise, the signal state is considered low.

You can select the threshold voltage on the source CAN for various types of integrated circuits in the "Technology" list, or set a user-defined value in "Threshold". You can also let the instrument set the appropriate threshold using "Find Level".

Changing the thresholds in the bus configuration changes also the thresholds of analog channels in the "Vertical" menu, or the thresholds of logic channels in the "Logic" menu.

Remote command:

[BUS:CAN:TECHnology](#) on page 401

[BUS:CAN:DATA:THReshold](#) on page 401

[BUS:SETReflevels](#) on page 376

[CHANnel<m>:THReshold:FINDlevel](#) on page 257

Bit rate, Predefined Bit Rates

Sets the number of transmitted bits per second. The maximum bit rate is 1 Mbit/s.

To select a bit rate from the list of predefined values, tap the "Predefined Bit Rates" field, then select the value.

To set a user-defined value, double-tap the "Bit Rate" field, then enter the value and unit using the displayed keypad. The "Predefined Bit Rates" setting is automatically set to "User Bit Rate".

Remote command:

[BUS:CAN:BITRate](#) on page 400

Sample Point

The CAN bus interface uses an asynchronous transmission scheme. The standard specifies a set of rules to resynchronize the local clock of a CAN node to the message.

The sample point divides the nominal bit period into two distinct time segments. The length of the time segments is defined in time quanta according to network and node conditions during CAN development.

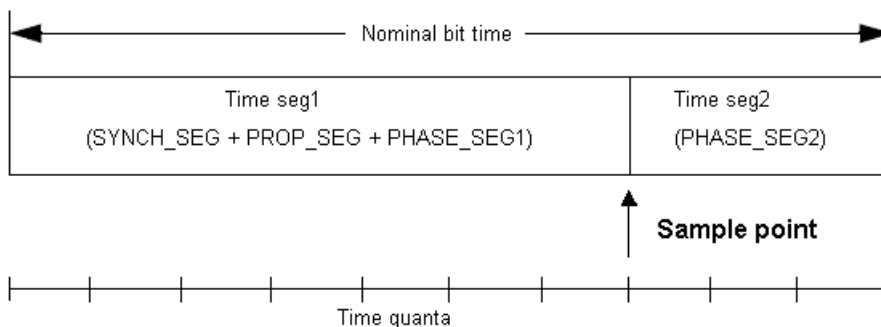

Remote command:

[BUS:CAN:SAMPlepoint](#) on page 401

8.5.2 CAN Trigger Settings

Access: SETUP (TRIGGER) > "Trigger type" = "Bus"

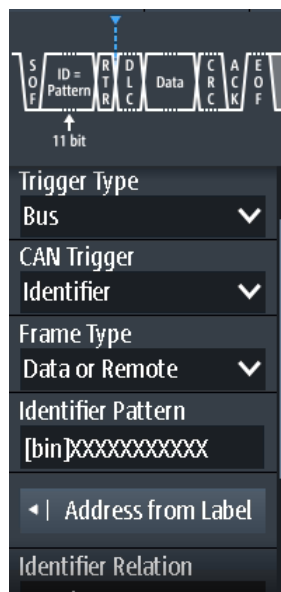

CAN Trigger.....	189
Frame type.....	190
ID type.....	190
Identifier Pattern.....	190
Identifier Relation.....	191
Data Pattern.....	191
Data Relation.....	191
Address from Label.....	191
Error conditions: CRC, Bit stuffing, Form, Ack.....	191

CAN Trigger

Depending on the selected CAN trigger type, different additional parameters are available.

"Start of Frame"

Triggers on the stop bit of the sync field.

"End of frame"

Triggers after a wakeup frame.

"Frame type"

Triggers on a specified frame type (data, remote, error, or overload). For data and remote frames, also the identifier format is considered.

"Identifier"

Sets the trigger to a specific identifier or an identifier range. Only the 6-bit identifier without parity bits is considered, not the protected identifier.

"Identifier + Data"

Sets the trigger to a combination of identifier and data condition. The instrument triggers at the end of the last byte of the specified data pattern.

"Error condition"

Identifies various errors in the frame. You can select one or more error types as the trigger condition.

Remote command:

[TRIGger:CAN:TYPE](#) on page 405

Frame type

CAN has several frame types which can be used as trigger condition.

For data and remote frames, the identifier format has to be set with [ID type](#).

"Error"	When a node recognizes an error, it cancels transmission by sending an error frame. The instrument triggers seven bit-periods after the end of the error flag that is marked by a dominant-recessive edge. The ID type is irrelevant for error frames.
"Overload"	When a node needs a delay between data and/or remote frames, it sends an overload frame. The instrument triggers seven bit-periods after the end of the overload flag that is marked by a dominant-recessive edge. The ID type is irrelevant for overload frames.
"Data"	The data frame is the only frame for actual data transmission.
"Remote"	Remote frames are only available in the CAN protocol. The remote frame initiates the transmission of data by another node. The frame format is the same as of data frames but without the data field.
"Data or Remote"	Data frames or remote frames initiate the transmission of data by another node. The frame format is the same as of data frames.

Remote command:

[TRIGger:CAN:FTYPE](#) on page 403

ID type

Selects the length of the identifier:

"11 bit"	Identifier length of the CAN base frame format. The instrument triggers on the sample point of the IDE bit (identifier extension flag).
"29 bit"	Identifier length of the CAN extended frame format. The instrument triggers on the sample point of the RTR bit.
"Any"	The ID type and ID pattern are not relevant for the trigger condition. If the trigger type is "Identifier", the instrument triggers on any identifier in the specified frame type. If the trigger type is "Identifier + Data", set the "ID type" to "Any" if you want to trigger only on data.

Remote command:

[TRIGger:CAN:ITYPE](#) on page 405

Identifier Pattern

Specifies the identifier pattern to be found, in binary or hex format. Enter the pattern in MSB first bit order.

See also [Chapter 2.5.12.1, "Pattern Definition"](#), on page 66.

Remote command:

[TRIGger:CAN:IDENTifier](#) on page 404

Identifier Relation

Defines how the specified identifier pattern is compared with the acquired signal. The instrument triggers if the acquired address is equal or unequal the defined pattern.

Remote command:

`TRIGger:LIN:ICONdition` on page 414

Data Pattern

Specifies the data pattern to be found, in binary or hex format. Enter the pattern in MSB first bit order.

See also [Chapter 2.5.12.1, "Pattern Definition"](#), on page 66.

Remote command:

`TRIGger:LIN:DATA` on page 414

Data Relation

Defines how the specified data pattern is compared with the acquired signal. The instrument triggers if the acquired address is equal or unequal the defined pattern.

Remote command:

`TRIGger:LIN:DCONdition` on page 414

Address from Label

If a label list with node names was loaded and applied in the bus configuration, you can select the node name from the list instead of entering the numeric identifier.

The instrument triggers on the identifier of the selected node.

Error conditions: CRC, Bit stuffing, Form, Ack

If a CAN detects a bit stuffing error, form error, or ack error, it transmits an error flag at the next bit. The R&S RTH detects errors in the message and triggers on these errors even if no CAN node sends an error flag.

- CRC error
CAN uses the cyclic redundancy check (CRC), which is a complex checksum calculation method. The transmitter calculates the CRC and sends the result in the CRC sequence. The receiver calculates the CRC in the same way. A CRC error occurs when the calculated result differs from the received value in the CRC sequence.
- Bit stuffing error
The frame segments Start Of Frame, Arbitration Field, Control Field, Data Field and CRC Sequence are coded by the bit stuffing method. The transmitter automatically inserts a complementary bit into the bit stream when it detects five consecutive bits of identical value in the bit stream to be transmitted. A stuff error occurs when the 6th consecutive equal bit level in the mentioned fields is detected.
- Form error
A form error occurs when a fixed-form bit field contains one or more illegal bits.
- Ack error
An acknowledgement error occurs when the transmitter does not receive an acknowledgment - a dominant bit during the ack slot.

Remote command:

TRIGger:CAN:ACKerror on page 402

TRIGger:CAN:BITSterror on page 402

TRIGger:CAN:CRCErrror on page 402

TRIGger:CAN:FORMerror on page 403

8.5.3 CAN Label List

Label list files (symbolic data files) for CAN protocols are available in PTT and CSV file formats, similar to other serial protocols. In addition, the R&S RTH can read and apply DBC files to the decoded signal and use them for triggering.

For general information on label lists, see [Chapter 8.1.3, "Label Lists"](#), on page 164.

8.5.3.1 PTT and CSV Files for CAN

PTT and CSV files are protocol-specific. A PTT label file for CAN protocols contains three values for each identifier:

- Identifier type, 11-bit or 29-bit long
- Identifier value
- Label, symbolic name of the identifier, specifying its function in the bus network.

Example: CAN PTT file

```
# -----
@FILE_VERSION = 1.00
@PROTOCOL_NAME = can
# -----
# Labels for CAN protocol
# Column order: Identifier type, Identifier value, Label
# -----
11,064h,Diag_Response
11,1E5h,EngineData
11,0A2h,Ignition_Info
11,1BCh,TP_Console
11,333h,ABSdata
11,313h,Door_Left
11,314h,Door_Right
29,01A54321h,Throttle
29,13A00FA2h,LightState
29,0630ABCDh,Engine_Status
29,03B1C002h,Airbag_Status
29,01234ABCh,NM_Gateway
# -----
```

8.5.3.2 DBC Files for CAN

Industry-standard DBC files contain more information than PTT and CSV files and translate the abstract decode results to human language. For each frame, the frame ID and the symbolic name of the ID are given; the frames are also called messages in CAN. The data of a CAN message can consist of several "signals". The DBC file provides the label, unit, start bit, length and other indicators for each signal. For state-encoded signals, the meaning of the states is given.

In the demo example, the message "EngineData" has the decimal ID 2,166,573,756 and consists of 8 data bytes. These 8 bytes are defined as 6 signals. The first one, "PetrolLevel", starts at bit #24, has a length of 8 bit, and the unit is liter. The signal "IdleRunning" is state-encoded. It has only one bit. The binary value 0 means "Running", and the binary value 1 means "Idle".

Example: CAN DBC file section

```
BO_ 2166573756 EngineData: 8 Engine
  SG_PetrolLevel : 24|8@1+ (1,0) [0|255] "l" ...
  SG_EngPower : 48|16@1+ (0.01,0) [0|350] "kW" ...
  SG_EngForce : 32|10@1+ (1,0) [0|1000] "N" ...
  SG_IdleRunning : 23|1@1+ (1,0) [0|1] "" ...
  SG_EngTemp : 16|7@1+ (2,-50) [-50|150] "degC" ....
  SG_EngSpeed : 0|13@1+ (1,0) [0|8000] "rpm" ...
  ....
  VAL_ 2166573756 IdleRunning 0 "Running" 1 "Idle" ;
```

If a DBC file is loaded, the bus menu provides an additional entry: [Display Labels](#).

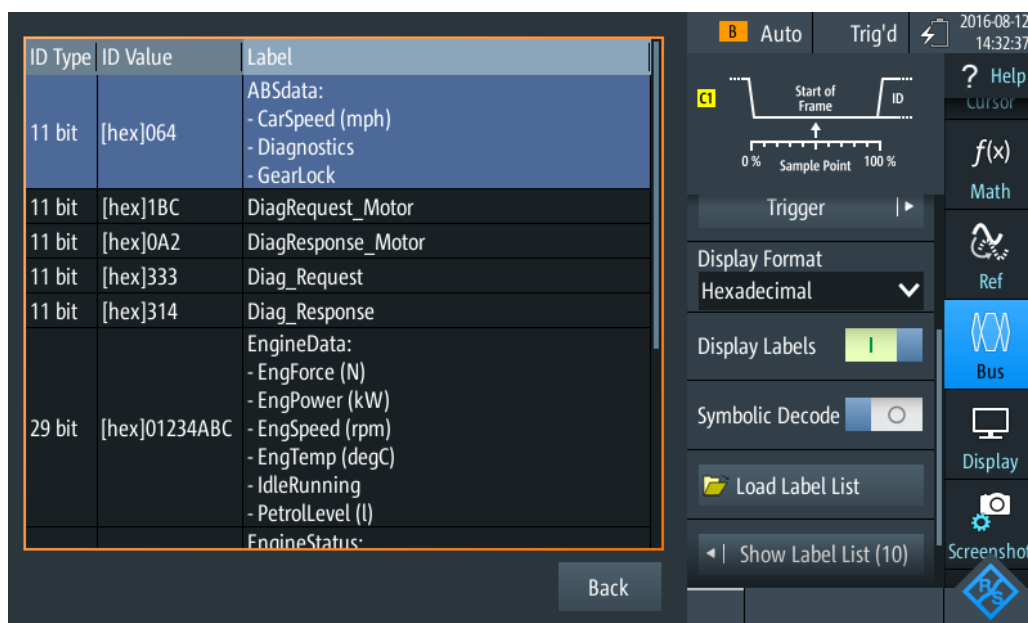

Figure 8-16: Display of an CAN DBC file

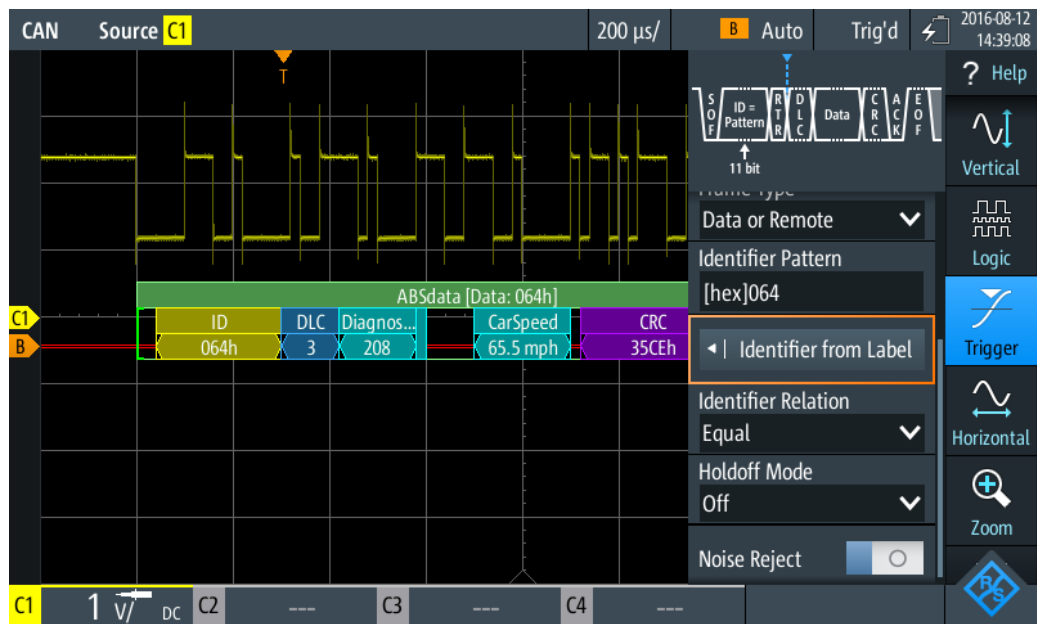

Figure 8-17: Trigger on message "ABSdata", identifier value 064 (hex)

8.5.4 CAN Decode Results

This chapter describes the comb display and the decode results table of decoded CAN buses. Basic information on decoding and display of decode results is given in [Chapter 8.1.2, "Decode Results"](#), on page 163.

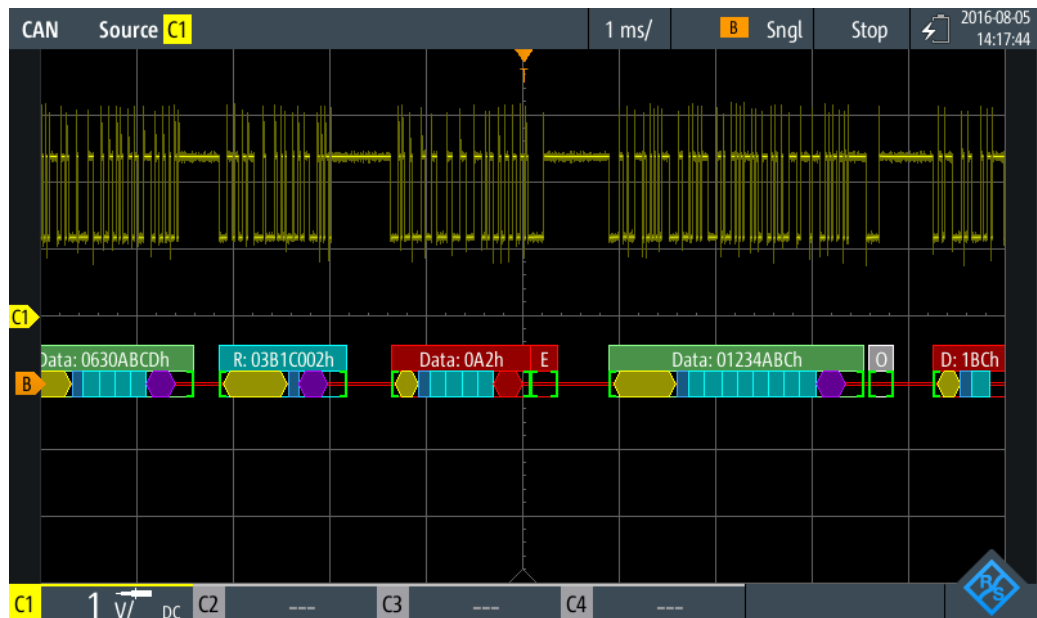

Figure 8-18: Comb display of a decoded CAN signal, triggered on CRC error

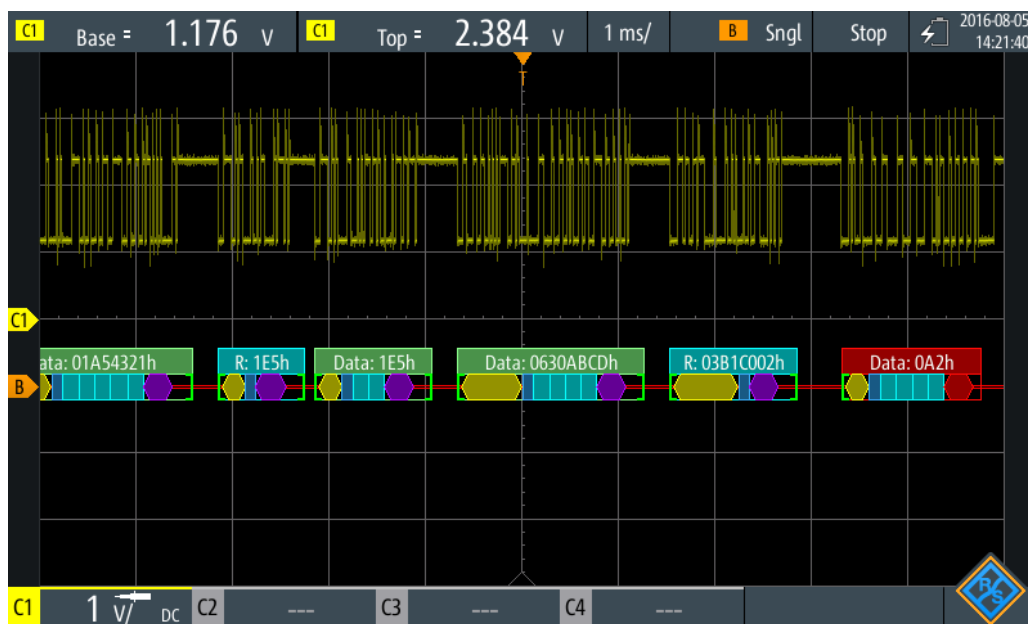

Figure 8-19: Comb display of a decoded CAN signal, triggered on address 0630ABCD (hex)

The color-coding of the various protocol sections and errors simplifies the interpretation of the visual display.

Table 8-7: Color codes of decoded CAN signals

Color, display element	Description
Green brackets [...]	Start and end of frame
Green frame header	Data frame. Text indicates the frame type and frame ID (hex).
Cyan frame header	Remote frame. Text indicates the frame type and frame ID (hex).
White frame header	Overload frame. Text indicates the frame type.
Yellow comb	ID (standard 11 bit and extended 29 bit)
Cyan comb	Data bytes
Blue comb	Data length code (DLC)
Violet	CRC
Red	Error frame, start/stop error, CRC error, stuff bit error, form error, ACK error, insufficient frame (end of acquisition before decoding has been completed)

In "Protocol" mode, decoded data is shown in tabular form.

Table 8-8: Content of the protocol table for decoded CAN signal

Column	Description
#	Frame index
Frame Start	Time of frame start
Frame Type	Data, remote, overload or error frame
ID bit	ID type, 11 bit standard format or 29 bit extended format

Column	Description
ID [hex]	Identifier value, hexadecimal value
DLC	Data length code, coded number of data bytes
Values 8 bit [format]	Values of data frames. The data format is selected in the "Bus" menu.
CRC	CRC value
State	Overall state of the frame. "Incomplete" indicates that the frame is not completely contained in the acquisition. Change the time scale to get a longer acquisition.

Remote control commands are described in [Chapter 14.11.5.3, "CAN Decode Results"](#), on page 405.

8.6 LIN (Option R&S RTH-K3)

The Local Interconnect Network (LIN) is a simple, low-cost bus system used within automotive network architectures. LIN is usually a subnetwork of a CAN bus. The primary purpose of LIN is to integrate uncritical sensors and actuators with low bandwidth requirements. Common applications in a motor vehicle are the control of doors, windows, wing mirrors, and wipers.

8.6.1 The LIN Protocol

This chapter provides an overview of protocol characteristics, frame format, identifiers and trigger possibilities. For detailed information, order the LIN specification on <http://www.lin-subbus.org/> (free of charge).

LIN characteristics

Main characteristics of LIN are:

- Single-wire serial communications protocol, based on the UART byte-word interface
- Single master, multiple slaves - usually up to 12 nodes
- Master-controlled communication: master coordinates communication with the LIN schedule and sends identifier to the slaves
- Synchronization mechanism for clock recovery by slave nodes without crystal or ceramics resonator

The R&S RTH supports several versions of the LIN standard: v1.3, v2.0, v2.1 and the American SAE J2602.

Data transfer

Basic communication concept of LIN:

- Communication in an active LIN network is always initiated by the master.

- Master sends a message header including the synchronization break, the synchronization byte, and the message identifier.
- The identified node sends the message response: one to eight data bytes and one checksum byte.
- Header and response form the message frame.

The data is transmitted in bytes using the UART byte-word interface without the parity bit. Each byte consists of a start bit, 8 bits and a stop bit.

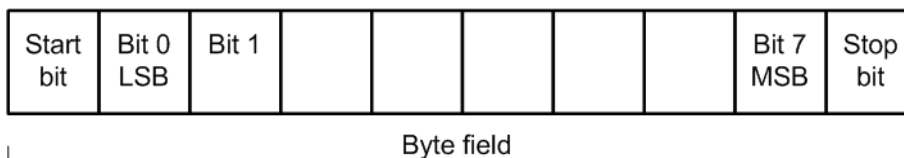

Figure 8-20: Structure of a byte field

Data bytes are transmitted LSB first.

The identifier byte consists of 6 bits for the frame identifier and two parity bits. This combination is known as protected identifier.

Trigger

The R&S RTH can trigger on various parts of LIN frames. The data line must be connected to an input channel, triggering on math and reference waveforms is not possible.

You can trigger on:

- Frame start (synchronization field)
- Specific slave identifier or identifier range
- Data pattern in the message
- Wake up signal
- Checksum error (error in data), parity error (error in identifier)

8.6.2 LIN Configuration Settings

Access: PROTOCOL > "Bus type" = "LIN" > "Configuration"

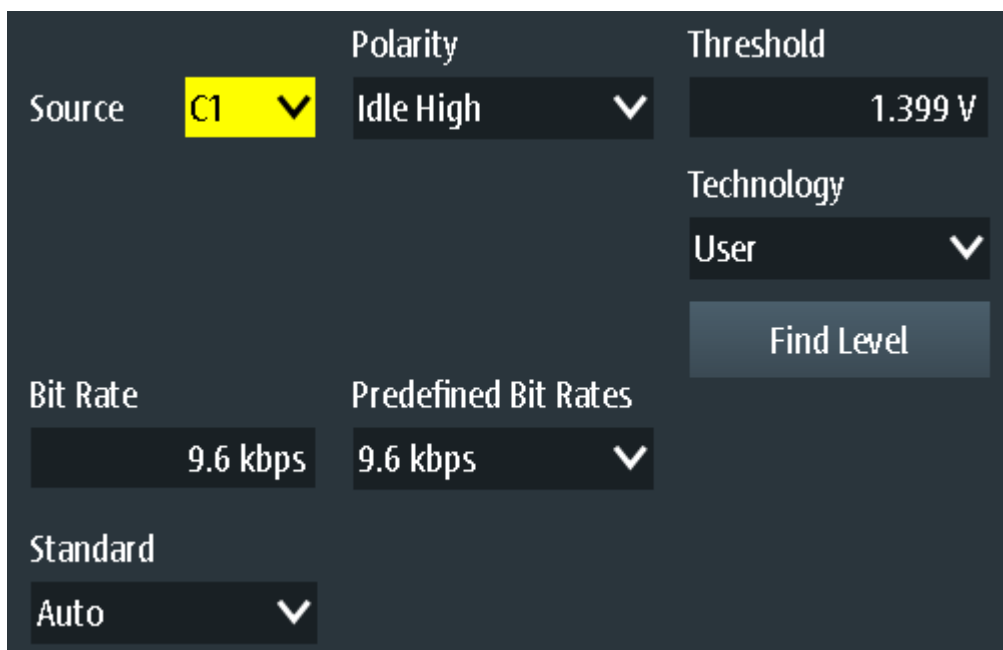

Source..... 198
 Polarity..... 198
 Standard..... 198
 Bit rate, Predefined Bit Rates..... 199
 Threshold, Technology, Find Level..... 199

Source

Sets the source of the data line. All active analog channels can be used. If option R&S RTH-B1 is installed, digital channels can also be used as source.

Remote command:
[BUS:LIN:DATA:SOURce](#) on page 411

Polarity

Defines the idle state of the bus. The idle state is the recessive state and corresponds to a logical 1.

- "Idle Low" The bus is idle (state = 1) when the signal is low
- "Idle High" The bus is idle (state = 1) when the signal is high

Remote command:
[BUS:LIN:POLarity](#) on page 412

Standard

Selects the version of the LIN standard that is used in the DUT. The setting mainly defines the checksum version used during decoding. The most common version is v2.x. For mixed networks, or if the standard is unknown, set the LIN standard to "Auto".

Remote command:
[BUS:LIN:STANdard](#) on page 412

Bit rate, Predefined Bit Rates

Sets the number of transmitted bits per second. The maximum bit rate is 20 kbit/s.

To select a bit rate from the list of predefined values, tap the "Predefined Bit Rates" field, then select the value.

To set a user-defined value, double-tap the "Bit Rate" field, then enter the value and unit using the displayed keypad. The "Predefined Bit Rates" setting is automatically set to "User Bit Rate".

Remote command:

[BUS:LIN:BITRate](#) on page 412

Threshold, Technology, Find Level

Sets the threshold value for digitization of signals. If the signal value is higher than the threshold, the signal state is high. Otherwise, the signal state is considered low.

You can select the threshold voltages for various technologies in the "Technology" list, or set a user-defined value in "Threshold". You can also let the instrument set the appropriate threshold using "Find Level".

Changing the thresholds in the bus configuration changes also the thresholds of analog channels in the "Vertical" menu, or the thresholds of logic channels in the "Logic" menu.

Remote command:

[BUS:LIN:TECHnology](#) on page 413

[BUS:LIN:DATA:THReshold](#) on page 412

[BUS:SETReflevels](#) on page 376

[CHANnel<m>:THReshold:FINDlevel](#) on page 257

8.6.3 LIN Trigger Settings

Access: SETUP (TRIGGER) > "Trigger type" = "Bus"



LIN Trigger.....	200
Checksum Error.....	200
Parity Error.....	200
Sync Error.....	200
Identifier Pattern.....	201
Identifier Relation.....	201
Identifier from Label.....	201
Data Pattern.....	201
Data Relation.....	201

LIN Trigger

Depending on the selected LIN trigger type, different additional parameters are available.

"Start of Frame"

Triggers on the stop bit of the sync field.

"Wakeup frame"

Triggers after a wakeup frame.

"Error condition"

Identifies various errors in the frame. You can select one or more error types as the trigger condition.

"Identifier"

Sets the trigger to a specific identifier or an identifier range. Only the 6-bit identifier without parity bits is considered, not the protected identifier.

"Identifier + Data"

Sets the trigger to a combination of identifier and data condition. The instrument triggers at the end of the last byte of the specified data pattern.

Remote command:

`TRIGger:LIN:TYPE` on page 415

Checksum Error

Triggers on a checksum error. The checksum verifies the correct data transmission. It is the last byte of the frame response. The checksum includes not only the data but also the protected identifier (PID).

Remote command:

`TRIGger:LIN:CHKSError` on page 413

Parity Error

Triggers on a parity error. Parity bits are the bits 6 and 7 of the identifier. They verify the correct transmission of the identifier.

Remote command:

`TRIGger:LIN:IPERror` on page 415

Sync Error

Triggers if synchronization caused an error.

Remote command:

`TRIGger:LIN:SYERror` on page 415

Identifier Pattern

Specifies the identifier pattern to be found, in binary or hex format. Enter the pattern in MSB first bit order.

See also [Chapter 2.5.12.1, "Pattern Definition"](#), on page 66.

Remote command:

`TRIGger:LIN:IDENTifier` on page 414

Identifier Relation

Defines how the specified identifier pattern is compared with the acquired signal. The instrument triggers if the acquired address is equal or unequal the defined pattern.

Remote command:

`TRIGger:LIN:ICONdition` on page 414

Identifier from Label

If a label list with node names was loaded and applied in the bus configuration, you can select the node name from the list instead of entering the numeric identifier.

The instrument triggers on the identifier of the selected node.

Data Pattern

Specifies the data pattern to be found, in binary or hex format. Enter the pattern in MSB first bit order.

See also [Chapter 2.5.12.1, "Pattern Definition"](#), on page 66.

Remote command:

`TRIGger:LIN:DATA` on page 414

Data Relation

Defines how the specified data pattern is compared with the acquired signal. The instrument triggers if the acquired address is equal or unequal the defined pattern.

Remote command:

`TRIGger:LIN:DCONDITION` on page 414

8.6.4 LIN Label List

Label lists are protocol-specific. Label lists for LIN are available in CSV and PTT format.

A LIN label file contains two values for each identifier:

- Identifier value
- Symbolic name for the identifier

Example of a LIN PTT file

```
# -----
@FILE_VERSION = 1.0
@PROTOCOL_NAME = lin
# -----
# Labels for LIN protocol
```

```
# Column order: Identifier, Label
# -----
# Labels for standard addresses
0x3F, Temperature
1Ch, Left brake
20h, Right brake
# Following ID is provided as integer
33, Mirror
0x37, Indoor lights
# Labels for reserved addresses
0x3C, Master_Request_Frame
0x3D, Slave_Response_Frame
# -----
```

For general information on label lists, see [Chapter 8.1.3, "Label Lists"](#), on page 164.

ID Value	Label
[hex]00000012	Pressure
[hex]00000013	Mirror
[hex]0000001C	Left brake
[hex]00000033	Speed
[hex]0000003F	Temperature

Figure 8-21: Display of a LIN label list

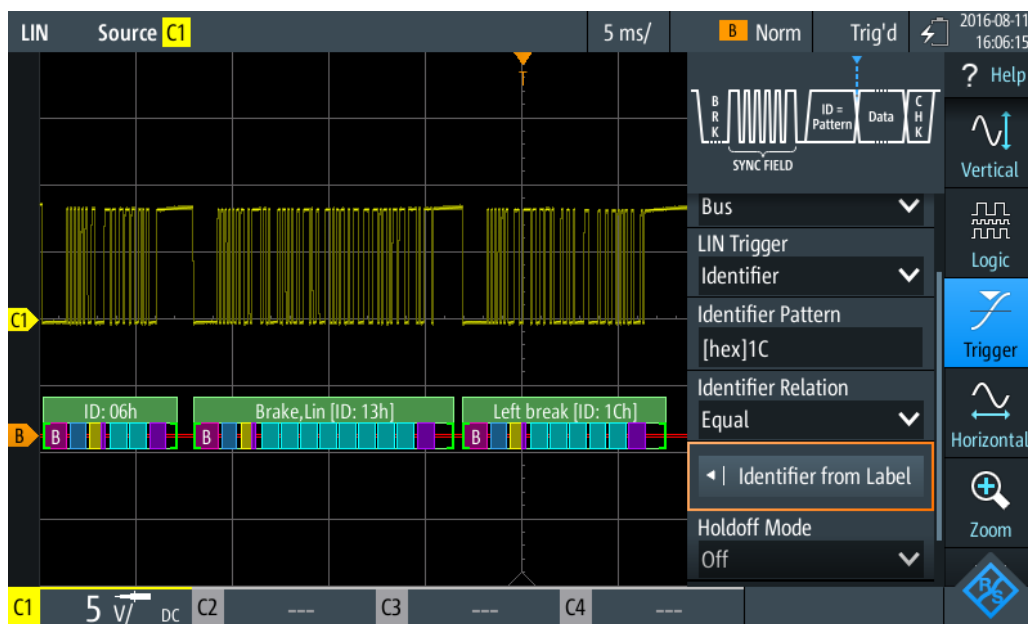

Figure 8-22: Trigger on identifier "Left brake"

8.6.5 LIN Decode Results

This chapter describes the comb display and the decode results table of decoded LIN buses. Basic information on decoding and display of decode results is given in [Chapter 8.1.2, "Decode Results"](#), on page 163.

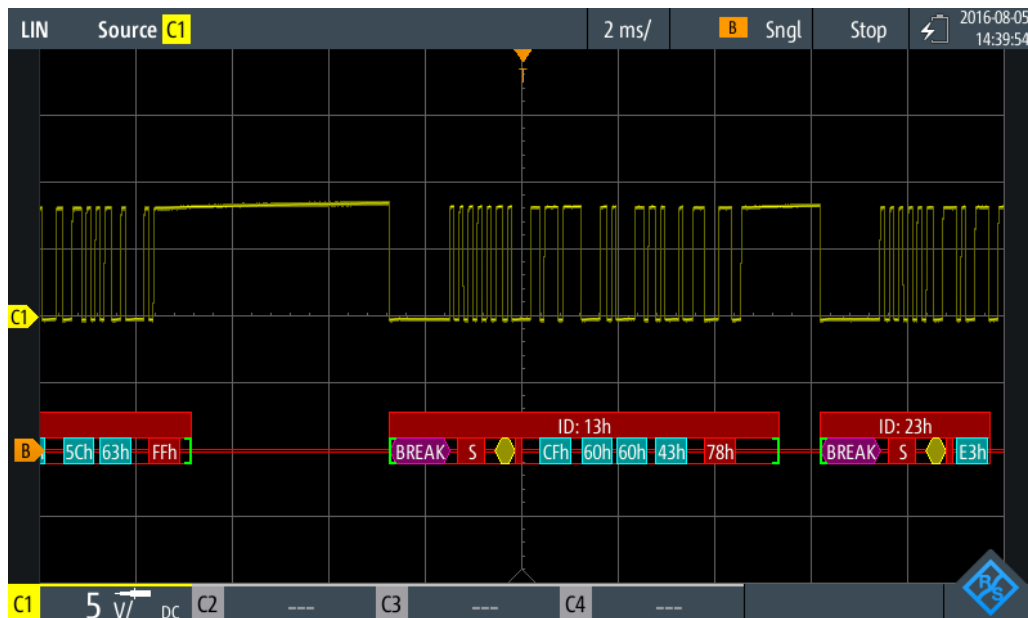

Figure 8-23: Comb display of a decoded LIN signal, triggered on parity error

The color-coding of the various protocol sections and errors simplifies the interpretation of the visual display.

Table 8-9: Color codes of decoded LIN signals

Color, display element	Description
Green brackets [...]	Start and end of frame
Green frame header	Data frame. Text indicates the frame ID (hex).
Magenta frame header	Wake-up frame. Text indicates the frame type.
Magenta comb	Break field
Blue comb	Synch field
Yellow comb	Identifier
Violet comb	Parity bit and checksum
Cyan comb	Data bytes
Red	Error in frame ID, checksum error, parity error, insufficient frame (end of acquisition before decoding has been completed)

In "Protocol" mode, decoded data is shown in tabular form.

Table 8-10: Content of the protocol table for decoded LIN signal

Column	Description
#	Frame index
Frame Start	Time of frame start
ID [hex]	Identifier value, hexadecimal value
ID Label	Symbolic name of the identifier. Column is shown instead of "ID [hex]" if a label list is used.
ID P [bin]	Value of the protected identifier, binary value
Values 8 bit [format]	Values of data bytes. The data format is selected in the "Bus" menu.
CHK [hex]	Checksum value, hexadecimal value
State	Overall state of the frame. "Incomplete" indicates that the frame is not completely contained in the acquisition. Change the time scale to get a longer acquisition.

Remote control commands are described in [Chapter 14.11.6.3, "LIN Decode Results"](#), on page 415.

9 Logic Analyzer (R&S RTH-B1 MSO)

The Mixed Signal Option R&S RTH-B1 adds logic analyzer functions to the classical oscilloscope functions. Using the logic analyzer, you can analyze and debug embedded systems with mixed-signal designs that use analog signals and time-correlated digital signals simultaneously. The option provides a logic probe with 8 logic channels. The instrument ensures that analog and digital waveforms are time-aligned and synchronized so that critical timing interactions between analog and digital signals can be displayed and tested.

Each logic channel can be displayed on the screen and used as trigger source.

- ▶ To activate the logic analyzer, shortly press the LOGIC key.
To disable, press LOGIC again.
- ▶ To configure logic channels, press and hold the LOGIC key until the "Logic" menu opens.

To scale and move the logic channels vertically:

1. If the logic channels are not focused, press the LOGIC key to set the focus.
2. Press the vertical RANGE and POS keys.

9.1 Logic Analyzer Settings

Access: "Logic" menu



Logic Channels

Enables or disables the logic channels.

Remote command:

[LOGic:STATE](#) on page 421

Visible

By default, all 8 logic channels are displayed. Disable the logic channels that you do not need for analysis.

Couple Thresh.

Couples the threshold and hysteresis settings for the logic channels.

If enabled, all logic channels use the same threshold and hysteresis settings.

If disabled, 2 channel groups are available, which can use different threshold and hysteresis settings: D0 - D3, and D4 - D7.

Remote command:

[LOGic:THCoupling](#) on page 421

Threshold

Sets the threshold value for the selected channel group, or for all logic channels. For each acquired sample, the instrument compares the input voltage with the threshold value. If the input voltage is above the threshold, the signal state "1" is stored. Otherwise, the signal state "0" is stored if the input voltage is below the threshold.

You can set the digital threshold in several ways:

- The same threshold and hysteresis are used for all logic channels: Enable "Threshold" and set the values for channels D0 - D3, and D4 - D7.
- Different thresholds and hysteresis are used for individual channel groups: Disable "Threshold" and set the threshold and hysteresis for each group.

You can select the threshold voltages for various types of integrated circuits in the list, or set a user-defined value.

"TTL"	1.4 V
"ECL"	-1.3 V
"CMOS"	2.5 V
"GND"	0 V (for CAN channels, requires option R&S RTH-K3)
"CAN"	2 V (for CAN channels, requires option R&S RTH-K3)
"7 V Supply"	7 V (for LIN channels, requires option R&S RTH-K3)
"12 V Supply"	12 V (for LIN channels, requires option R&S RTH-K3)
"18 V Supply"	18 V (for LIN channels, requires option R&S RTH-K3)

Remote command:

[LOGic:GROup<m>:TECHnology](#) on page 421

[LOGic:GROup<m>:USER](#) on page 422

Hysteresis

Hysteresis avoids the change of signal states due to noise oscillation around the threshold level. Set a small hysteresis for clean signals, and large hysteresis for noisy signals.

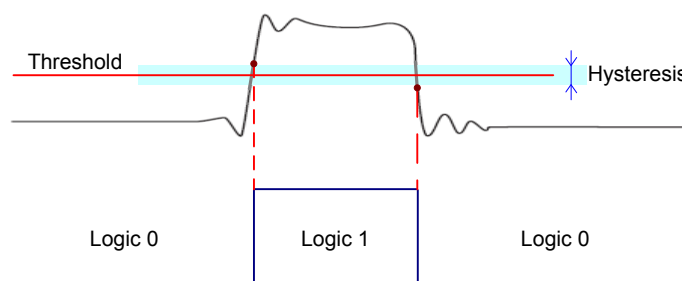

Remote command:

[LOGic:GROup<m>:HYSTeresis](#) on page 423

Deskew

Enables deskewing.

Deskew compensates delays that are known from the circuit specifics or caused by the different length of cables. The skew between the probe boxes of the digital channels and the probe connectors of the analog channels is automatically aligned by the instrument.

Select Channel, Deskew

You can set the deskew for all channels of a logic probe at once, or for each logic channel separately.

Select the channel and enter the deskew value in "Deskew".

Remote command:

`LOGic:CHANnel<m>:DESKew` on page 423

Set all Deskews to Zero

Resets all deskew values to zero.

9.2 Triggering on Logic Channels

Each digital channel can be used as trigger source. Using the pattern trigger, you can trigger on logical combinations of analog and digital channels. Additionally, you can define a trigger holdoff time.

If you trigger on logic channels, the threshold is used as trigger level. The "Trigger Level" setting is not available.

The following trigger types are available if the trigger source is a logic channel:

- Edge
- Glitch
- Width
- Pattern: the pattern can use all active logic channels
- State: the pattern can use all active logic channels
- Data2Clock: only the clock can be a logic channel.
- Serial pattern: clock and data source can be logic channels.
- Timeout
- Interval
- Window

All trigger types except for edge, glitch and width require option R&S RTH-K19.

For analysis of serial protocols, you configure the protocol using logic channels as sources, and trigger on trigger type "Bus". For details, see the chapter describing the relevant bus.

9.3 Analyzing Logic Channels

The main analysis tools for logic channels are serial protocol analysis (BUS), and the pattern and state triggers.

Furthermore, you can zoom into the display (ZOOM).

To measure logic channels, you can use automatic and cursor measurements as usual. The following measurement types are available:

- Period
- Frequency

- Positive and negative pulse width
- Positive and negative duty cycle
- Delay (only automatic measurements)
- Phase (only automatic measurements)
- Mean
- Positive and negative pulse count
- Rising and falling edge count

See also [Chapter 3.2, "Automatic Measurements"](#), on page 75 and [Chapter 3.3, "Cursor Measurements"](#), on page 81.

You can also export the waveform data: FILE > "Waveforms"

10 Frequency Counter (R&S RTH-K33)

The frequency counter is only available if the counter mode option R&S RTH-K33 is installed.

The R&S RTH measures frequencies in various ways:

- You can use the automatic measurement function in scope mode.
- The FFT analysis mode converts the data into the frequency domain, providing a spectrum of the input signal (see [Chapter 5.1, "FFT Mode"](#), on page 103). During FFT analysis, the frequency resolution is restricted by the selected data acquisition settings (channel bandwidth, frequency span, and time scale).
- To determine the frequency of an input signal accurately without changing the data acquisition settings, the R&S RTH is equipped with a signal counter function. The signal counter counts the zero crossings of the input signal (thus the term *signal counter*) and derives the precise frequency value.

The R&S RTH counter mode option provides two separate counters. One counter can be used as a reference for the second one, so that the deviation from the reference value can be compensated for and the frequency becomes more accurate. Alternatively, both counters can measure different input signals.

Using the data logger, you can also store a series of frequency values measured by the counter over time.

10.1 Accessing the Counter Mode

1. Press the MODE key.



2. Select "Counter".

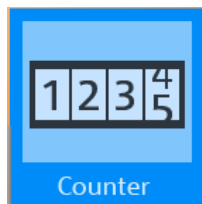

10.2 Display and Control

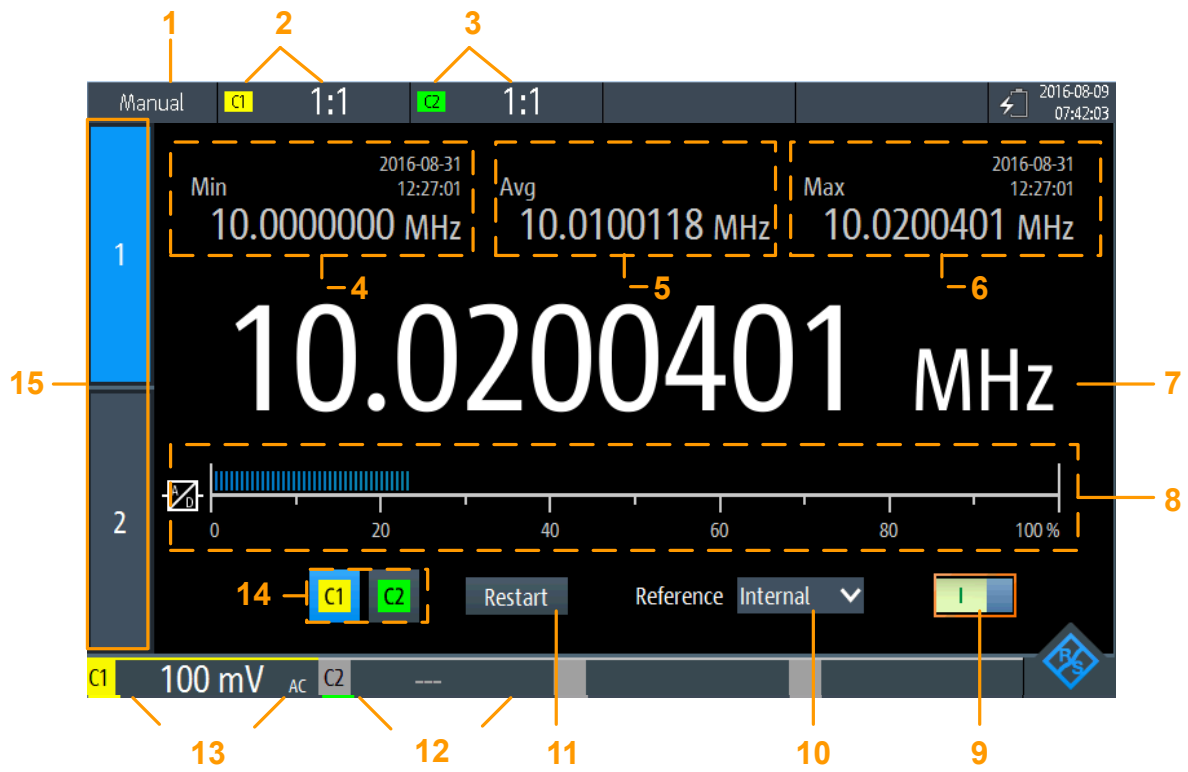

Figure 10-1: Display for basic counter

- 1 = Measurement state. "Manual": running measurement with manual range; "Hold": stopped measurement
- 2 = Vertical settings for channel 1 (incl. "Probe Setting")
- 3 = Vertical settings for channel 2 (incl. "Probe Setting")
- 4 = Minimum frequency and timestamp
- 5 = Average frequency
- 6 = Maximum frequency and timestamp
- 7 = Currently measured frequency
- 8 = Bargraph indicating the load level of the A/D converter for the selected measurement range; for values $\geq 100\%$, an overload warning is displayed; for optimal results the load level should be above 20 %;
- 9 = Counter on/off switch
- 10 = Used reference (Internal or Counter 2)
- 11 = Restarts the measurement and resets all values
- 12+13 = Measurement ranges of active channels
- 14 = Channel input selection
- 15 = Counter selection

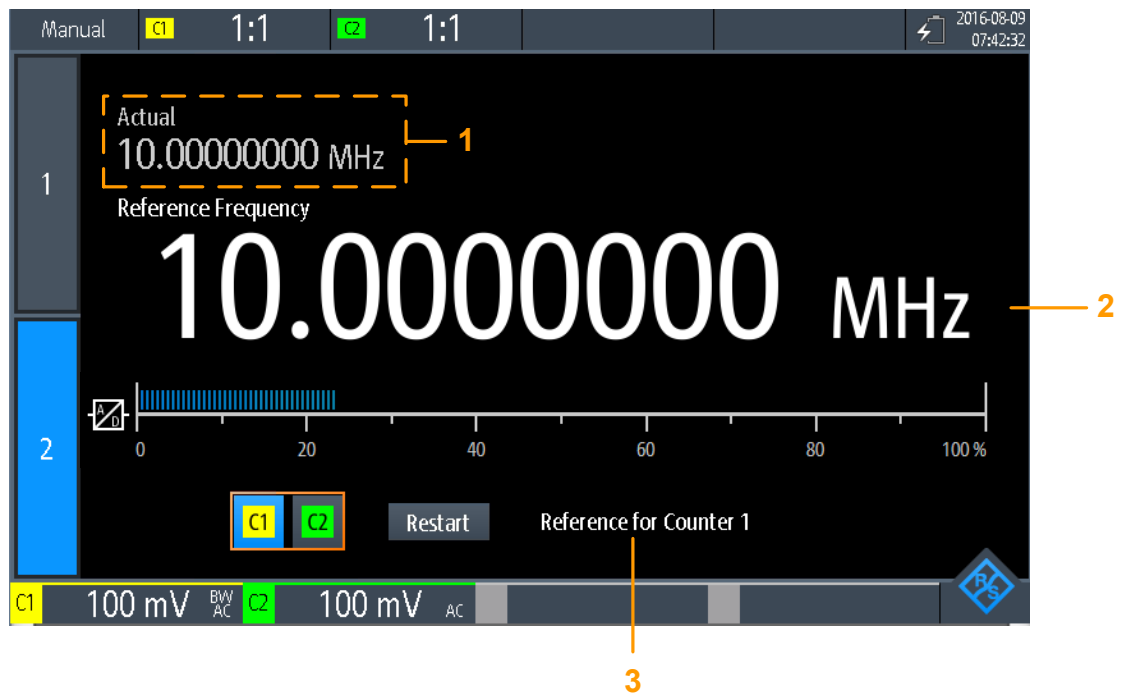

Figure 10-2: Display for reference counter

- 1 = Measured frequency at basic counter
- 2 = Measured frequency at reference counter (used as a reference frequency for basic counter)
- 3 = Counter usage

If both counters are active, you can display both measured counter frequencies at the same time. When both counter results are displayed simultaneously, only the measured frequencies and the load bargraphs are displayed. Statistics or additional settings are not available.

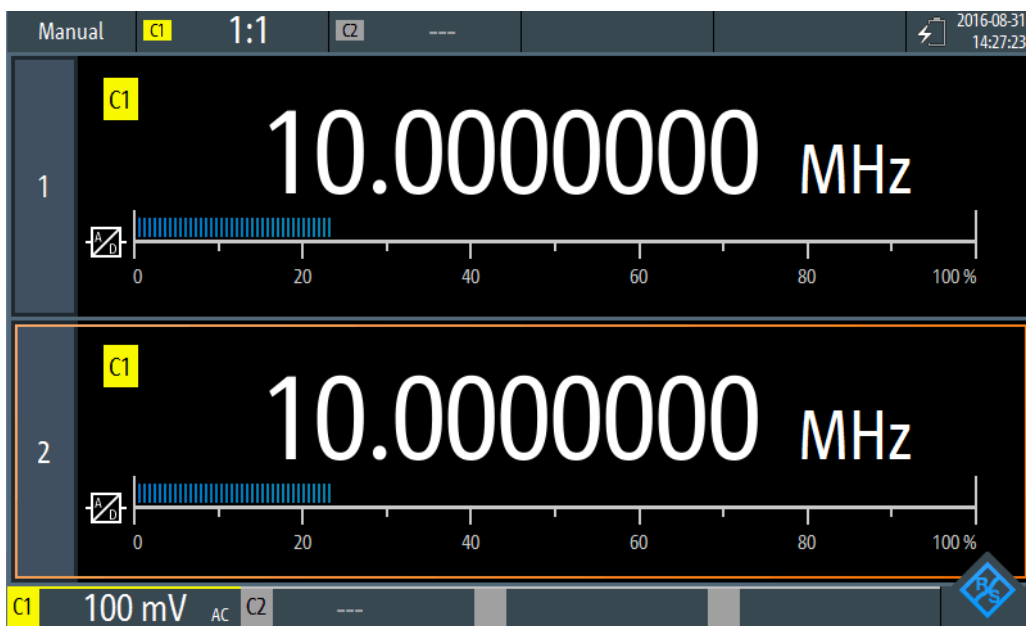



Figure 10-3: Display for two counters simultaneously

1. To display both counters, tap the currently highlighted counter selection tab.
2. To return to a single counter display, tap one of the counter selection tabs.

In counter mode, the keys behave slightly different from scope mode:

- The vertical RANGE and POS keys adjust the measurement range.
- The MEAS key opens the "Counter" menu.
- The following keys work as usual: FILE, , , PRESET, MODE, BACK.
- All other keys do not work.

Measurement Mode.....	213
Current Result.....	214
Minimum.....	214
Maximum.....	214
Average.....	214

Measurement Mode

Tap the setting to switch between continuous measurement ("MANUAL") and a single measurement ("HOLD"). This has the same effect as selecting the TRIGGER RUN STOP key.

For a single measurement, the continuous measurement is stopped and the most recent value is displayed.

During continuous measurements, the most recent value is preserved and displayed, while the oldest values are overwritten.

Note: The statistical values are not reset when the measurement is stopped. They are only reset after you manually select [Restart](#).

Remote command:

[COUNTER<m>:SENSe:TRIGger:MODE](#) on page 364

[COUNTER<m>:INITiate](#) on page 362

[COUNTER<m>:ABORt](#) on page 359

Current Result

The currently measured counter frequency.

Remote command:

[COUNTER<m>:READ?](#) on page 363

[COUNTER<m>:FETCh?](#) on page 361

[COUNTER<m>:MEASure:FREQuency?](#) on page 362

Minimum

The minimum of all measured counter frequencies since statistics were last restarted.

Remote command:

[COUNTER<m>:CALCulate:AVERage:MINimum?](#) on page 360

[COUNTER<m>:CALCulate:AVERage:ALL?](#) on page 359

Maximum

The maximum of all measured counter frequencies since statistics were last restarted.

Remote command:

[COUNTER<m>:CALCulate:AVERage:MAXimum?](#) on page 360

[COUNTER<m>:CALCulate:AVERage:ALL?](#) on page 359

Average

The average of all measured counter frequencies since statistics were last restarted.

Remote command:

[COUNTER<m>:CALCulate:AVERage:AVERage?](#) on page 359

[COUNTER<m>:CALCulate:AVERage:ALL?](#) on page 359

10.3 Performing a Counter Measurement

To perform a basic counter measurement without a reference

1. Before you can perform a counter measurement, adjust the waveforms by editing the vertical, horizontal, trigger and acquisition settings.

For details see:

- [Chapter 2.2, "Vertical Setup"](#), on page 38
- [Chapter 2.3, "Horizontal Setup"](#), on page 42
- [Chapter 2.5, "Trigger"](#), on page 46
- [Chapter 2.4, "Acquisition Control"](#), on page 43

2. To adjust the instrument settings to the current input signal automatically, press AUTOSET.

3. Select the "Counter" mode.
4. Select the channel to be used as input for the counter.
5. Activate the first (basic) counter.
A continuous measurement starts and the signal counter indicates the measured frequency. With each new measurement, the statistical values are updated.
6. To start and stop a counter measurement, press the RUN STOP key.



7. Optionally, activate a second basic counter.
 - a) Select the second counter tab.
 - b) Select the input channel for the counter.
 - c) Activate the counter.
 - d) Tap the second counter tab again to display both counter results simultaneously.

To perform a counter measurement with a second counter as a reference

1. Before you can perform a counter measurement, adjust the waveforms by editing the vertical, horizontal, trigger and acquisition settings.
For details see:
 - [Chapter 2.2, "Vertical Setup"](#), on page 38
 - [Chapter 2.3, "Horizontal Setup"](#), on page 42
 - [Chapter 2.5, "Trigger"](#), on page 46
 - [Chapter 2.4, "Acquisition Control"](#), on page 43
2. To adjust the instrument settings to the current input signal automatically, press AUTOSET.
3. Select the "Counter" mode.
4. Select the "Counter" menu.
5. Select the channel to be used as input for the basic counter.
6. Select "Reference": "Counter 2".
7. Define the (nominal) "Reference Frequency" to be assigned to the value measured on counter 2.
8. Activate the first (basic) counter.
A continuous measurement starts and the signal counter indicates the measured frequency. With each new measurement, the statistical values are updated. The second counter is also activated automatically.
9. Tap "Select Counter": "2".
10. Select the input channel for the reference counter 2. Make sure the selected channel provides a precise signal with the specified reference frequency.

If the measured reference frequency deviates extremely from the specified frequency, a warning is displayed.

11. Select "Restart" to reset the statistical values and start a new measurement with the reference frequency.

The deviation of the nominal frequency to the measured frequency is internally removed from the measured frequency. The display indicates the accurate frequency of the input signal.

12. Optionally, tap the second counter tab again to display both counter results simultaneously.
13. To start and stop a counter measurement, press the RUN STOP key.

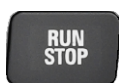

10.4 Counter Settings

Access: "Counter" menu



Additional settings for vertical scaling are available for Counter mode and directly accessible via the "Counter" menu. For a description see:

- ["Channel Index"](#) on page 38
- ["Probe Setting"](#) on page 39
- ["Bandwidth"](#) on page 39

Furthermore, the logger function can be used to store counter values, see [Chapter 7, "Data Logging"](#), on page 147.

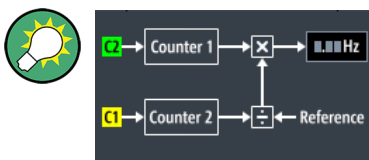
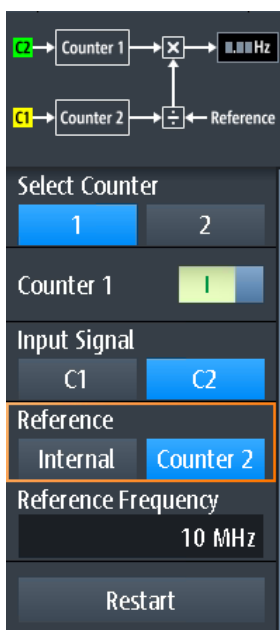

The diagram at the top of the "Counter" menu indicates how the data will be processed using the current settings.

Select Counter.....	217
Counter 1 / 2 State.....	217
Input Signal.....	217
Reference.....	218
Restart.....	218

Select Counter

Selects the counter to be configured.

Remote command:

Suffix for COUNTER, see [Chapter 14.9, "Counter Mode \(R&S RTH-K33\)"](#), on page 358

Counter 1 / 2 State

Activates or deactivates the basic counter.

Remote command:

COUNTER<m>:SENSe:STATe on page 364

Input Signal

Selects one of the channels as the input for the counter measurement.

Remote command:

COUNTER<m>:SENSe:SOURce on page 364

Reference

Selects the reference to be used for the counter.

"Counter 1 / 2" The measured value of the other counter is used as a reference. Specify the nominal "Reference Frequency" for counter 2. The deviation of the nominal frequency to the measured reference frequency is internally removed from the measured frequency of counter 1.

"Internal" An internal reference is used to determine the counter frequency.

Remote command:

[COUNter<m>:SENSe:REFerence:STATe](#) on page 363

[COUNter<m>:SENSe:REFerence:VALue](#) on page 364

Restart

Resets all statistical values and starts a new counter measurement.

Remote command:

[COUNter<m>:CALCulate:AVERage:CLEar](#) on page 359

[COUNter<m>:INITiate](#) on page 362

11 Documenting Results

- ▶ To access export and data functions, press the FILE key.

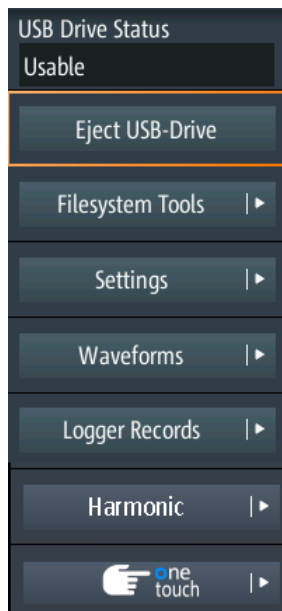

- ▶ To configure screenshots, press and hold the  key until the menu opens.

The R&S RTH can store various data to files for further analysis and reporting:

- [Instrument Settings](#)
- [Waveforms](#)
- [Logger Records](#)
- [Screenshots](#)
- Harmonic results (see [Chapter 5.3, "Harmonics Measurement \(Option R&S RTH-K34\)"](#), on page 125).

You can also combine these data and save it to file by pressing the  key: [Quick Save with OneTouch](#).

To check the storage devices and manage the data files, the [Filesystem Tools](#) menu provides various functions.

11.1 Using USB Flash Drive

You can connect a USB flash drive on the right side of the instrument. If a USB flash drive is connected, all screenshots and result data are written to this external device by default. Instrument settings are saved on the instrument, but you can store them to the USB flash drive as well.

1. To check the status of the USB flash drive, press the FILE key.
The connection status is shown on the top of the menu.

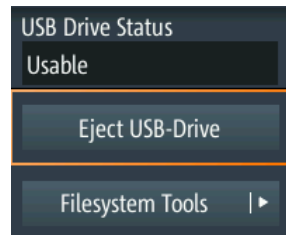

2. To remove the USB flash drive from the instrument, tap "Eject USB Drive" in the "File" menu.
3. To check the file system on the USB flash drive for errors, tap "Filesystem Tools" > "Check USB Drive".

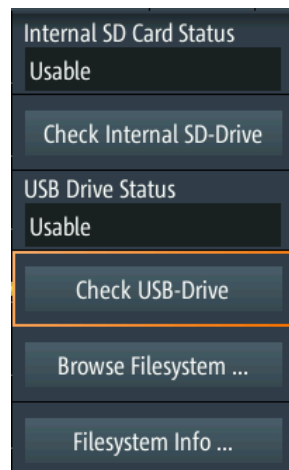

11.2 Filesystem Tools

Access: FILE > "Filesystem Tools"

The "Filesystem Tools" help you to check the storage devices and manage the data files.

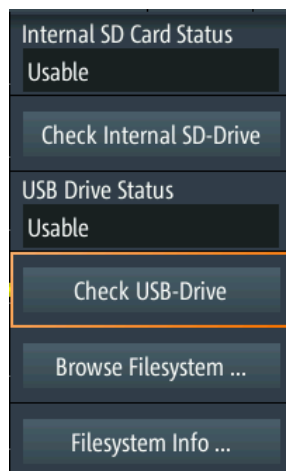
**Internal SD Card Status**

Shows the status of the internal SD card.

Check Internal SD Drive

Checks the file system on the SD card for errors.

USB Drive Status

Shows the status of the USB flash drive: "Usable", "Safe to remove", or "Not available".

See also: [Chapter 11.1, "Using USB Flash Drive"](#), on page 219.

Check USB Drive

Checks the file system on the USB flash drive for errors.

See [Chapter 11.1, "Using USB Flash Drive"](#), on page 219.

Browse Filesystem

Opens a file explorer, where you can check the files on the SD card and on the USB flash drive. You can rename and delete files, and create folders. Some options help to navigate and select files.

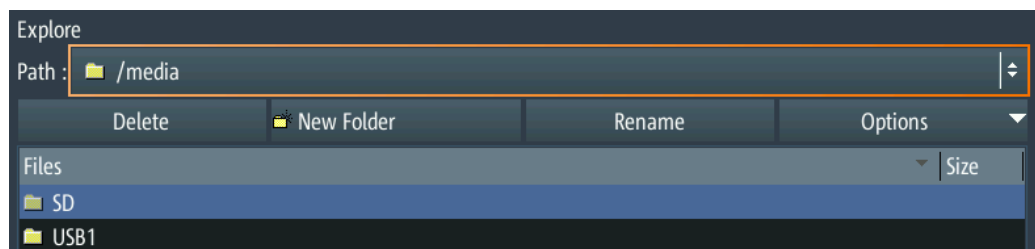
**Filesystem Info**

Shows the overall and free space that is available on the connected storage devices.

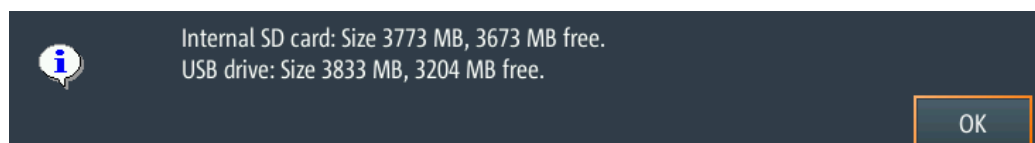

11.3 Instrument Settings

To repeat measurements or tests at different times or perform similar measurements with different test data, you can save the used configuration settings for later use. Furthermore, it can be helpful to refer to the configuration settings of a particular measurement when analyzing the results. Therefore, you can easily save the complete measurement configuration including the display settings.

The R&S RTH provides two ways to store the measurement configuration:

- Save as fast setting
- Save as saveset

11.3.1 Using Fast Settings

The R&S RTH has 8 slots to save and load often used configuration settings very quickly.

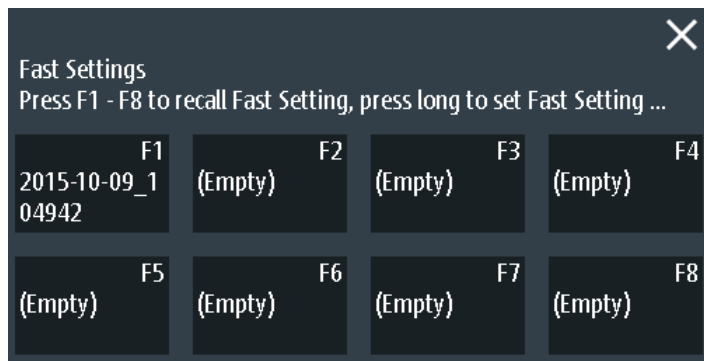

To save the current setting as fast setting

1. Press the SHIFT key.
2. Tap and hold one of the storage slots F1...F8.
The online keyboard opens.
3. Type the settings name and tap ↵.
The configuration settings are saved to the slot.

To load a fast setting

1. Press the SHIFT key.
2. Tap the storage slot that holds the required configuration.
The settings are loaded.

Alternatively, you can save and load fast settings in the "File" menu: FILE > "Settings" > "Fast Settings".

11.3.2 Saving and Loading Savesets

You can save and reload an unlimited number of configuration setups. By default, the settings are stored on the microSD card in the following directory:

```
media/SD/Rohde-Schwarz/RTH/SaveSets
```

The storage location can be changed. The file format is XML.

To save the current settings in a saveset

1. Press the FILE key.
2. Tap "Settings".
3. The current storage location is shown in "Setting Directory".
 - To store the file under a default name in the specified directory, tap "Save Setting".
 - To store the file in another directory and/or with a user-defined filename, tap "Save Setting As". Select the path, directory, and enter the filename.

To load and display a saveset

1. Press the FILE key.
2. Tap "Settings".
3. The current storage location is shown in "Setting Directory".
 - To load a file from the specified directory, tap "Load Setting".
 - To load a file from another directory, tap "Setting Directory" and change the directory. Tap "Load Setting".
4. Select the file to be loaded.

Description of settings



Load Setting

Opens the specified directory. Tap the file to be loaded.

Save Setting

Saves the settings to the specified directory with a default filename. The filename pattern is: <filename base>_<date>_<time>.xml.

Save Setting As

Opens a file selection dialog. Navigate to the target directory and enter the filename. Tap "Save" to store the file.

Setting Directory

Sets the directory to which the settings are stored with the "Save Setting" function.

Filename Base

Defines the first part of the filename. The complete filename pattern is:
<filename base>_<date>_<time>.xml.

11.4 Waveforms

Analog channel and math waveforms can be saved in several ways:

- As reference waveforms for later use on the instrument: "Ref" menu. See: [Chapter 3.5, "Reference Waveforms"](#), on page 87
- In CSV file on a USB flash drive or internal SD card for further analysis using other applications: FILE > "Waveforms". This way is described in the current chapter.

If you want to save many waveforms, you can assign the function to the  key. See: [Chapter 11.6, "Quick Save with OneTouch"](#), on page 230.

11.4.1 Exporting Waveforms to File

The waveform export provides the following possibilities:

- Store either one waveform or all active waveforms.
- Include time values.
- Option R&S RTH-K15: Save history data.
- Option R&S RTH-B1: Save logic channels.

If a USB flash drive is attached, the file is stored there. Otherwise, the file is stored in the `Export` folder on the microSD card.

1. Activate the waveforms that you want to export.
2. Press the FILE key.
3. Select "Waveforms".

4. Tap "Select Waveform" and select one waveform for export, or select all active waveforms.
5. Select the "File Format"
6. Check the "Waveform Directory", the "Filename Base", and the "CSV Column Delimiter". Adjust if necessary.
7. If you need time information for analysis, enable "Store with Time".
8. If you want to save history data, enable "Save History".
9. Tap "Save Waveform".

All export settings are described in [Chapter 11.4.2, "Waveform Export Settings"](#), on page 225.

11.4.2 Waveform Export Settings

Access: FILE > "Waveforms"



Select Waveform

Select the waveform to be exported. You can export:

- A single analog channel or math waveform
- All active digital channels
- All active waveforms at once

Remote command:

[EXPort:WAVeform:SOURce](#) on page 425

[EXPort:WAVeform:MULTichannel](#) on page 426

Save History

This function is only available if option R&S RTH-K15 is installed. It includes the waveform history in the data export. If acquisition is running, enabling "Save History" stops the acquisition. History data is always saved in "Compressed CSV" files.

For details, see [Chapter 3.7.4, "Exporting History Data"](#), on page 96

File Format

Selects the format of the export file.

"CSV"	Comma-separated values (CSV) text file, the waveform is stored in a table. The columns are separated by commas or another delimiter. For each sample, one line is written. Values are listed in scientific notation. You can convert the comma-separated text to columns.
"Compressed CSV"	ZIP file that contains one or more CSV files. This format reduces the file size.

Remote command:

[EXPort:WAVeform:NAME](#) on page 425

Save Waveform / Save Waveform As

Save the waveform data. The functions are available if the instrument is in a waveform mode ("Scope", "XY", "Mask", "Roll", "Mask").

"Save Waveform"	Saves the file in the defined "Waveform Directory" using the auto-naming pattern.
"Save Waveform As"	Opens a file explorer where you can select the directory and enter the filename.

Remote command:

[EXPort:WAVeform:SAVE](#) on page 427

Waveform Directory

Defines the directory where the waveform files are stored. If a USB flash drive is connected, the instrument stores the data to this external device by default.

Remote command:

[EXPort:WAVeform:NAME](#) on page 425

Filename Base

Defines the first part of the filename. The complete filename pattern is:

```
<filename base>_<date>_<time>.csv|zip.
```

Remote command:

[EXPort:WAVeform:NAME](#) on page 425

Store with Time

Includes horizontal values in the export data (time values).

Remote command:

[EXPort:WAVeform:INCXvalues](#) on page 426

CSV Column Delimiter

Selects the column delimiter for CSV files. You need to know the delimiter when you convert the CSV text to columns in a spreadsheet.

11.4.3 Waveform Export Files

Waveform data is stored in CSV or compressed CSV format.

A CSV file is a comma-separated values (CSV) text file, the waveform is stored in a table. The columns are separated by commas or another delimiter. For each sample, one line is written. Values are listed in scientific notation. You can convert the comma-separated text to columns.

11.4.3.1 Content of Waveform Files

The first lines of the file contain header data, for example, time scale, vertical scale, vertical and horizontal positions. Header data is required to interpret the waveform data, and to analyze the data values of the data file.

Model	RTH1002												
SerialNumber													
Firmware Version	'1.20.3.2'												
Timestamp													
Waveform Type	ANALOG			Waveform Type	ANALOG			Waveform Type	DIGITAL				
Acquisition Mode	SAMPLE												
Horizontal Unit	s			Horizontal Unit	s			Horizontal Unit	s				
Horizontal Scale	5,00E-08			Horizontal Scale	5,00E-08			Horizontal Scale	5,00E-08				
Horizontal Position	0			Horizontal Position	0			Horizontal Position	0				
Reference Point	50%			Reference Point	50%			Reference Point	50%				
Sample Interval	4,00E-10			Sample Interval	4,00E-10			Sample Interval	6,67E-05				
Record Length	1250			Record Length	1250			Record Length	750				
Probe Setting	'1:1'	'20:1'											
Vertical Unit	V	V		Vertical Unit	V/div			Vertical Unit					
Vertical Scale	0.02	1		Vertical Scale				Threshold	1.4	1.4	1.4	1.4	
Vertical Position	0	0											
Vertical Offset	0	0											
	CH1	CH2			MATH<-C1>			D7	D6	D5	D4		
	0.000627	0.0471			-0.000627			0	0	0	0	0	0
	-0.00157	-0.0471			0.00157			0	0	0	0	0	0
	-0.00314	-0.0471			0.00314			0	0	0	0	0	0
	-0.00439	-0.0471			0.00439			0	0	0	0	0	0
	-0.00533	-0.0471			0.00533			0	0	0	0	0	0
	-0.00659	-0.0471			0.00659			1	1	1	1	1	1
	-0.00784	-0.0471			0.00784			1	1	1	1	1	1
	-0.00847	-0.0471			0.00847			1	1	1	1	1	1

Figure 11-1: Waveform data file with voltage values, text converted to columns

By default, only Y-values are stored. You can include the time values in the file.

Model	RTH1002													
SerialNumber														
Firmware Version	'1.20.3.2'													
Timestamp														
Waveform Type	ANALOG			Waveform Type	ANALOG			Waveform Type	DIGITAL					
Acquisition Mode	SAMPLE													
Horizontal Unit	s			Horizontal Unit	s			Horizontal Unit	s					
Horizontal Scale	5.00E-08			Horizontal Scale	5.00E-08			Horizontal Scale	5.00E-08					
Horizontal Position	0			Horizontal Position	0			Horizontal Position	0					
Reference Point	50%			Reference Point	50%			Reference Point	50%					
Sample Interval	4.00E-10			Sample Interval	4.00E-10			Sample Interval	6.67E-10					
Record Length	1250			Record Length	1250			Record Length	750					
Probe Setting	'1:1'			'20:1'										
Vertical Unit	V			V	Vertical Unit	V/div			Vertical Unit					
Vertical Scale	0.02			1	Vertical Scale				Threshold	1.4				
Vertical Position	0			0										
Vertical Offset	0			0										
TIME	CH1	CH2	TIME	MATH<-C1>	TIME	D7	D6	D5	D4					
-2.50E-07	0.000627	0.0471	-2.50E-07	-0.000627	-2.50E-07	0	0	0	0					
-2.50E-07	-0.00157	-0.0471	-2.50E-07	0.00157	-2.49E-07	0	0	0	0					
-2.49E-07	-0.00314	-0.0471	-2.49E-07	0.00314	-2.49E-07	0	0	0	0					
-2.49E-07	-0.00439	-0.0471	-2.49E-07	0.00439	-2.48E-07	0	0	0	0					
-2.48E-07	-0.00533	-0.0471	-2.48E-07	0.00533	-2.47E-07	0	0	0	0					
-2.48E-07	-0.00659	-0.0471	-2.48E-07	0.00659	-2.47E-07	1	1	1	1					
-2.48E-07	-0.00784	-0.0471	-2.48E-07	0.00784	-2.46E-07	1	1	1	1					
-2.47E-07	-0.00847	-0.0471	-2.47E-07	0.00847	-2.45E-07	1	1	1	1					

Figure 11-2: Waveform data file with voltage and time values, text converted to columns

If the acquisition mode is envelope or peak detect, two values (minimum and maximum) are written for each sample. The file contains two columns for each active analog channel.

Model	RTH1002													
SerialNumber														
Firmware Version	'1.30.1.11_Beta'													
Timestamp														
Waveform Type	ANALOG			Waveform Type	ANALOG									
Acquisition Mode	ENVELOPE													
Horizontal Unit	s			Horizontal Unit	s									
Horizontal Scale	1.00E-07			Horizontal Scale	1.00E-07									
Horizontal Position	1.06E-22			Horizontal Position	1.06E-22									
Reference Point	50%			Reference Point	50%									
Sample Interval	4.00E-10			Sample Interval	4.00E-10									
Record Length	2500			Record Length	2500									
Probe Setting	'1:1'			'1:1'	'20:1'	'20:1'								
Vertical Unit	V			V	V	V	Vertical Unit	V/div						
Vertical Scale	0.05			0.05	0.04	0.04	Vertical Scale							
Vertical Position	0			0	0	0								
Vertical Offset	0			0	0	0								
		CH1 MAX	CH1 MIN	CH2 MAX	CH2 MIN					MATH<-C1>				
		0.0243	-0.0251	-0.0295	-0.0696					-0.0243				
		0.0259	-0.0227	0.0696	0.0307					-0.0259				
		0.0275	-0.022	0.0709	0.0295					-0.0275				
		0.029	-0.0212	0.0696	0.0307					-0.029				
		0.0298	-0.0196	0.0696	0.0289					-0.0298				
		0.0314	-0.0196	0.0696	0.0295					-0.0314				
		0.0322	-0.018	0.0696	0.0301					-0.0322				

Figure 11-3: Waveform data file with two voltage values per sample, acquisition mode is envelope

11.4.3.2 Header Data

The header lines contain the following properties:

Value	Description
Timestamp	Only for history export
Waveform Type	ANALOG for analog channel signals and math waveforms, DIGITAL for logic signals
Acquisition Mode	Acquisition mode that has been used: sample, peak detect, high resolution, average, envelope. If peak detect or envelope is set, two values (minimum and maximum) are written for each sample. Only for analog channels.
Horizontal Unit	s, second
Horizontal Scale	In s/div
Horizontal Position	Distance of the trigger point from the reference point.
Reference Point	Position in the diagram: left = 10%, middle = 50%, and right = 90%
Sample Interval	Time between two samples
Record Length	Number of samples, corresponds to the number of data lines in the file
Probe Setting	Attenuation factor of the connected probe, only for analog channels.
Vertical Unit	V or A
Vertical Scale	In V/div or A/div, only for analog channels and math waveforms.
Vertical Position	In divisions, only for analog channels
Vertical Offset	In V or A, only for analog channels
Threshold	Only for digital channels

11.4.3.3 Converting CSV to Excel Files

If you open an exported CSV file in Excel or another spreadsheet, all data is written in one column. The value delimiter is usually a comma, but you can select another delimiter in the export settings. As an example, the following procedure describes text conversion to columns in Excel. Other spreadsheet applications provide similar features. Make sure to select the correct text delimiter, decimal separator and thousands separator.

1. Open the CSV file in Excel.
2. Click the column header "A" to select all data.
3. On the "Data" ribbon, click "Text to Columns".
4. Select the data type "Delimited".
Click "Next".
5. Select the delimiter that you have used in the export file (usually a comma).

- Click "Next".
- Click "Advanced".
 - Select the point as decimal separator and the comma as thousands separator.

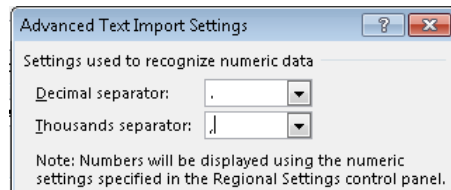

- Click "Finish".

11.5 Logger Records

See [Chapter 7.6, "Logger Records"](#), on page 156.

11.6 Quick Save with OneTouch

The  key initiates one or more assigned saving actions. By default, the key saves a screenshot.

If OneTouch is enabled, you can assign the following actions to the  key:

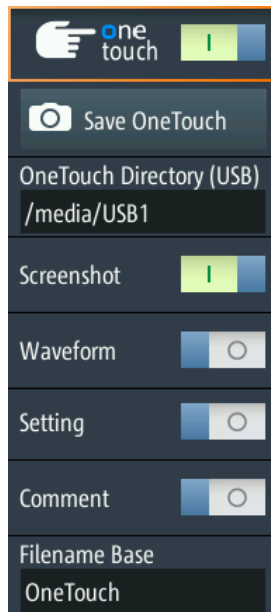

- Save a screenshot
- Save waveforms
- Save harmonic measurement results (requires option R&S RTH-K34)
- Save spectrum analysis results (requires option R&S RTH-K18)
- Save settings
- Add a comment to the saved file.

Access: FILE > "one touch", or "Screenshot" menu > "one touch"



One touch

Switches the function of the  key:

- If OneTouch is disabled, the  key saves a screenshot of the current display.
- If OneTouch is enabled, the  key can also save waveform data and settings in addition to the screenshot.

Save OneTouch

Saves the selected data to a ZIP file.

OneTouch Directory

Defines the directory where the OneTouch ZIP files are stored. If a USB flash drive is connected, the instrument stores the data to this external device by default.

Screenshot, Waveform, Setting

Select the data that you want to include in the OneTouch file.

Comment

If enabled, you can enter a comment when you save a OneTouch file. The comment is written to a text file, which is included in the ZIP file. Furthermore, the first 10 characters of the comment are added to the ZIP filename.

Filename Base

Defines the first part of the filename. The complete filename pattern is:

```
<filename base>_<date>_<time>_<comment10ch>.zip.
```

11.7 Screenshots

You can create and save screenshots of the current display of your waveforms and measurement results. If a USB flash device is connected to the R&S RTH, the instrument saves the screenshot to the USB flash drive. Otherwise, the screenshots are saved on the microSD card.



To save the current display in a screenshot:

1. Press the FILE key.
2. Disable "One touch".
3. Press the  key each time when you want to save a screenshot.

To configure the screenshots:

- ▶ Press and hold the  key until the menu opens, or open the "Screenshot" menu using the "Menu" button.

You can also view all saved screenshots directly on the instrument.

11.7.1 Screenshot Settings

Access: "Screenshot" menu

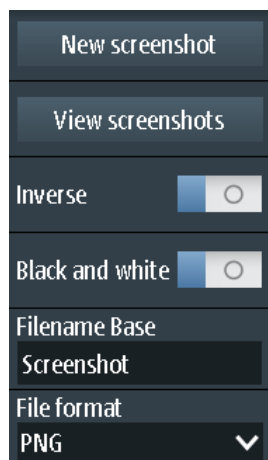

New screenshot

Saves the current display in a new screenshot.

Remote command:

[HCOPY:IMMEDIATE](#) on page 430

View screenshots

Displays the last saved screenshot. You can browse all screenshots that are saved.

Inverse

Inverts the colors of the output, i.e. a dark waveform is printed on a white background.

Remote command:

[HCOPY:INVerse](#) on page 430

Black and White

Creates a black and white screenshot.

Remote command:

[HCOPY:COLor](#) on page 430

Filename base

Defines the prefix of the file name. By default, the filename has the prefix "Screenshot_".

Remote command:

[MMEMoRY:NAME](#) on page 430

File format

Defines the format of the screenshot file. The following formats are available:

- PNG: Portable Network Graphics is a graphic format with lossless data compression.
- JPG: compressed file format, compression according to to JPEG standard
- BMP: BitMaP is an uncompressed format, files are large and saving might take some time.
- TIFF: Tagged Image File Format, often used in publishing companies and print processing.

Remote command:

[HCOPY:LANGuage](#) on page 430

12 General Instrument Setup

The general instrument settings are available in all operating modes.

12.1 Resetting the Instrument

Reset is helpful if the instrument is in undefined condition and cannot be operated.

- ▶ To switch off the instrument and reset the hardware, press the  power key for 5 seconds.
- ▶ To restore the factory settings, hold down the PRESET key during the boot process.

12.2 Disabling the Touchscreen

If you use the instrument in an environment with immissions considerably higher than specified, the immissions can affect the touch sensitivity of the screen. In this case, operate the instrument using the keys and the wheel and disable the touchscreen.

- ▶ To disable the touchscreen, press the SHIFT key for 2 seconds.

12.3 Selfalignment

Access:  or "Setup" menu > "Selfalignment"

The self-alignment aligns the data from several input channels vertically and horizontally to synchronize the timebases, amplitudes and positions.

The R&S RTH1002 provides an additional, separate self-alignment of the meter inputs.

Recommendation on performing the self-alignment:

- When putting the instrument into operation for the first time
- After a firmware update
- Once a week
- When major temperature changes occur (> 5°)

NOTICE

Warm-up and prepare the instrument

Make sure that the instrument has been running and warming up before you start the self-alignment. The minimum warm-up time is indicated in the data sheet.

Before the self-alignment, remove all probes, leads, and other connected lines from the instrument input.

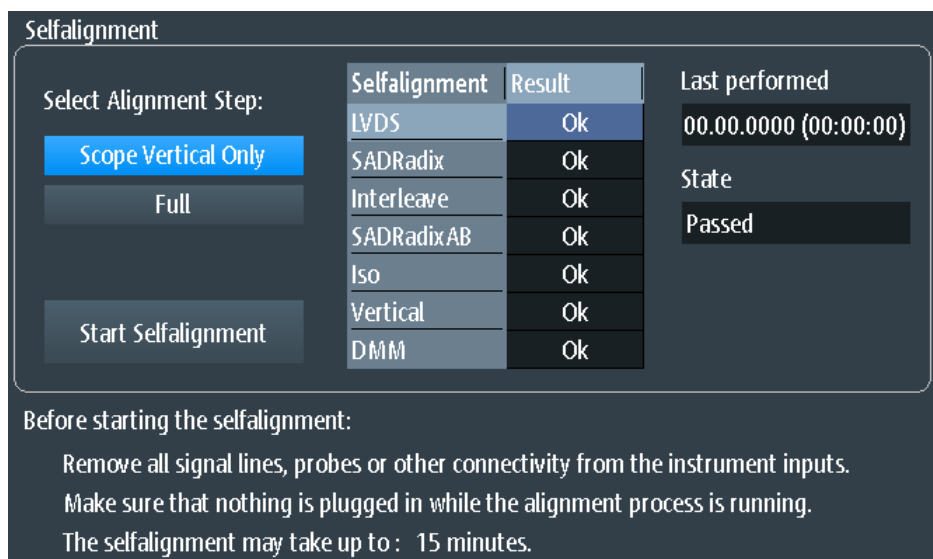

Figure 12-1: Self-alignment in scope mode

- ▶ To start, tap "Start Selfalignment".
The alignment can take up to 15 minutes. The results are shown in the "Selfalignment" dialog box.

R&S RTH1002: Self-alignment of DMM inputs

If the instrument is in "Meter" mode, you can choose to align all inputs, or only the meter inputs. The self-alignment of the meter inputs takes up to 30 seconds, while the complete self-alignment takes up to 15 minutes.

Selfalignment

Select Alignment Step:

DMM Only

Full

Start Selfalignment

Selfalignment	Result
LVDS	Ok
SADRadix	Ok
Interleave	Ok
SADRadixAB	Ok
Iso	Ok
Vertical	Ok
DMM	Ok

Last performed
00.00.0000 (00:00:00)

State
Passed

Before starting the selfalignment:
Remove all signal lines, probes or other connectivity from the instrument inputs.
Make sure that nothing is plugged in while the alignment process is running.
The selfalignment may take up to : 30 seconds.

12.4 Setting the Date, Time and Language

The instrument has a date and time clock. You can adjust the clock to the local time, and you can select the display language. Supported languages are listed in the data sheet. The help is provided in English.

A reboot of the instrument is not necessary.

Set date and time

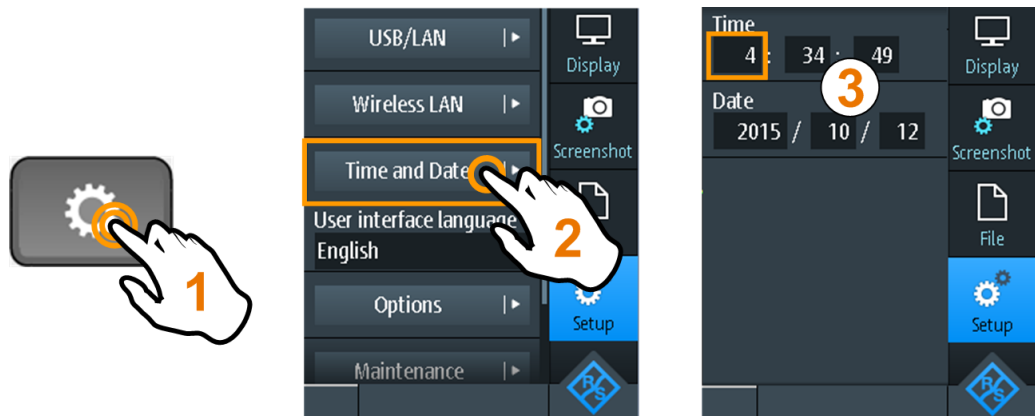

Set display language
 **Description of settings**
User Interface Language

Select the language in which the functions and messages are displayed. Supported languages are listed in the data sheet. The help is provided in English.

The instrument changes the language after a few seconds, a reboot is not required.

Time

Set the local time in the following order: hours / minutes / seconds.

Remote command:

[SYSTem:TIME](#) on page 437

Date

Set the date in the following order: year / month / day.

Remote command:

[SYSTem:DATE](#) on page 436

12.5 Instrument Settings

Access:  or "Setup" menu

**Enable Touch**

Switches the touch functionality of the screen on or off. Alternatively, you can press the SHIFT key for 2 seconds.

If you use the instrument in an environment with immissions considerably higher than specified, the immissions can affect the touch sensitivity of the screen. In this case, operate the instrument using the keys and the wheel and disable the touchscreen.

Remote command:

`DISPlay:MOUS` on page 438

Selfalignment

See [Chapter 12.3, "Selfalignment"](#), on page 234.

Selftest

The self-test checks the hardware of the instrument. It is intended for service tasks.

USB/LAN

See [Chapter 13.1, "LAN Connection"](#), on page 245 and [Chapter 13.2, "USB connection"](#), on page 247.

Wireless LAN

See [Chapter 13.3, "Wireless LAN Connection \(Option R&S RTH-K200/200US\)"](#), on page 247.

Time and Date

See [Chapter 12.4, "Setting the Date, Time and Language"](#), on page 236.

User Interface Language

See [Chapter 12.4, "Setting the Date, Time and Language"](#), on page 236.

Options

See [Chapter 12.7, "Options"](#), on page 240

Maintenance

The "Device Info" tab provides service information for your R&S RTH. If you need support, you may be asked to provide this information. Here you can also read the "Open Source Acknowledgment", which provides verbatim license text of open source software that is used in the instrument's firmware.

The "Service" tab allows the service personnel to enter a password that activates further service functions.

Firmware Update

See [Chapter 12.8, "Updating the Firmware"](#), on page 243.

12.6 Display Settings

Access: "Display" menu

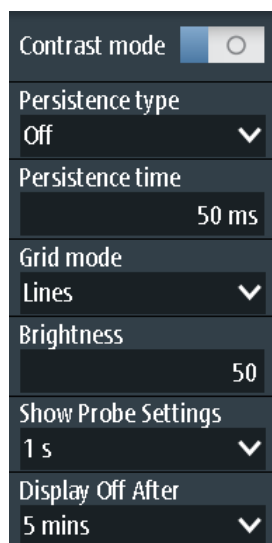
**Contrast Mode**

If enabled, the waveforms are displayed in black color on white background.

Remote command:

`DISPlay:CONTRast` on page 438

Persistence Type

Defines how long every new data point remains on the screen.

"Off" Deactivates persistence.

"Time" Data points remain on the screen for the duration defined with [Persistence Time](#).

"Infinite" Data points remain on the screen infinitely until persistence is set to "Off".

Remote command:

`DISPlay:PERSistence[:TYPE]` on page 437

Persistence Time

User-defined persistence time if "Persistence Type" is "Time". Each new data point remains on the screen for the duration defined here.

Remote command:

`DISPlay:PERSistence:TIME` on page 438

Grid Mode

Defines the grid display. A grid helps you identify the position of specific data points.

"Off" No grid is shown.

"Dots" Dots mark the intersections of the gridlines.

"Lines" Displays the grid as horizontal and vertical lines.

Brightness

Changes the brightness of the touchscreen.

Show Probe Settings

Defines how long the probe settings of active channels are shown when you press a channel key. The settings are shown on the top of the display.

The probe settings are always shown as long as the "Vertical" menu is open.

Display Off After

Defines when the display switches off if it is not used. Switching off the display saves energy and prolongs the battery's operating time.

12.7 Options

All options are activated by license keys. No additional installation or hardware change is required.



Unregistered licenses

Unregistered licenses are not assigned to a particular instrument. The instrument accepts only registered licenses. If your license is delivered unregistered, use the online tool R&S License Manager to register the license for your instrument. The registration of a permanent license is irreversible, so ensure that you register it for the correct instrument. The address of the tool is <https://extranet.rohde-schwarz.com/service>.

The "Active options" tab provides information on installed software options. Here you can install new options or deactivate existing options using license keys.

Active options | Inactive options | Deactivated options

Description	Activation type	Valid until
K1 I2C/SPI Trigger & Decode	Permanent	
K2 UART/RS232 Trigger & Decode	Permanent	
B1 Mixed-Signal-Opt. 250 MHz	Permanent	
B242 200 MHz Option, RTH1004	Permanent	
K19 Advanced Trigger	Permanent	
K200 Wireless LAN	Permanent	

Required information to order an option

Material number	1317.5000K04
Serial number	900079
Device ID	1317.5000K04-900079-Fw

Install a new option

Enter new option key

Install from file ...

The "Inactive options" tab lists all deactivated and expired options.

Active options | Inactive options | Deactivated options

Description	Activation type	Valid until	Remark
K200 Wireless LAN	Permanent	-	deactivated

The "Deactivated options" tab shows all deactivated options with their deactivation information and provides a function to export the deactivation response. The response is required by the R&S License Manager.

Active options	Inactive options	Deactivated options
Description	Key	Response
K200 Wireless LAN	010263902420031714993030926	04690C3456E888B6B

 Export deactivation response ...

12.7.1 Activating Options

Consult your sales representative and provide the material number, serial number, and the device ID of your instrument to get a license key. You find this information in  > "Options" > "Active options".

The license key is provided in written form or in a file. Unregistered licenses must be registered in the R&S License Manager before they can be activated on the instrument.

1. If you received the option key in a file, save the file to a USB flash drive, and connect the drive to the R&S RTH.
2. Press the  key.
3. Select "Options", and select the "Active options" tab.

Active options		Inactive options	Deactivated options
Description	Activation type	Valid until	
K1 I2C/SPI Trigger & Decode	Permanent		
K2 UART/RS232 Trigger & Decode	Permanent		
B1 Mixed-Signal-Opt. 250 MHz	Permanent		
B242 200 MHz Option, RTH1004	Permanent		
K19 Advanced Trigger	Permanent		
K200 Wireless LAN	Permanent		

Required information to order an option		Install a new option
Material number	1317.5000K04	Enter new option key
Serial number	900079	
Device ID	1317.5000K04-900079-Fw	Install from file ...

- If you received a key in written form, enter the key in the "Enter new option key" field.
If you received a key in digital form as a file, tap "Install from file", select path /media/USB1, and select the option key file.
- If you want to activate several options, repeat step 3 for each option.
- Restart the instrument.

12.8 Updating the Firmware

Your instrument is delivered with the latest firmware version. Firmware updates are provided on the Internet at www.rohde-schwarz.com/product/rth.html > "Downloads" > "Firmware". Along with the firmware file, you find the Release Notes describing the improvements and modifications.

Make sure to update the firmware if a new version is available.

- Download the firmware installation file RTH*.rsi, and save it to a USB flash drive.
- Connect the USB flash drive to the USB connector on the right panel of the instrument.
- Press .
- Scroll down the menu and tap "Open File" under "Firmware Update".
- Select the firmware file.
If you cannot see the RTH*.rsi file, select the path /media/USB1, and the folder that contains the file.
- Tap "Select".

7. Tap "Yes".

The firmware update starts. Wait until the update has finished. The instrument restarts automatically.

13 Network Connections

This chapter describes the setup of network connections.

There are several ways to connect the R&S RTH to a computer:

- Connect the instrument to a local area network (LAN), usually the company network. For this connection, ethernet technology is used.
LAN connection is used for remote operation using the web interface option R&S RTH-K201, for remote control using SCPI commands, and for data transfer.
- Connect the instrument directly to a computer using USB.
The direct USB connection is used for remote control using SCPI commands.
- Connect the instrument to the wireless LAN (requires option R&S RTH-K200).
You can operate the instrument remotely using a web browser on the computer or mobile device.

13.1 LAN Connection

1. Connect the LAN cable to the LAN connector on the right panel of the instrument.
2. Press the  key.
3. Select "USB/LAN".
4. Select "Interface" = "Ethernet". By default, DHCP is used and all address information is assigned automatically.
5. Note the IP address, which is required to address the instrument in the network.

Description of settings

Interface	Ethernet 
Status	Ready (Eth. connected)
Hostname	RTH-900079
DHCP	<input checked="" type="checkbox"/>
IP Address (DHCP)	10.113.1.159
Subnet mask (DHCP)	255.255.252.0
Gateway (DHCP)	10.113.0.1
DNS Server (DHCP)	10.0.2.166
MAC Address	00:90:B8:1D:E4:70

Interface

Select LAN or USB connection.

Status

Shows the connection status.

Hostname

Shows the computer name of the instrument.

In a LAN that uses a Domain Name System server (DNS server), each computer or instrument can be accessed using a unique name instead of the IP address. The DNS server translates the host name to the IP address. The host name is useful when a DHCP server is used, as a new IP address is assigned each time the instrument is restarted.

The default name is RTH-<serial_number>. You can change the name, but make sure that the name is unique in the LAN.

DHCP

Enables dynamic TCP/IP configuration using the Dynamic Host Configuration Protocol (DHCP). If DHCP is on, all address information is assigned automatically. Disable DHCP if the network does not support this protocol.

IP Address, Subnet mask, Gateway, DNS Server

Shows the IP address and other address information for LAN connection.

If the network supports DHCP, the DHCP server assigns these parameters. It is safe to establish a connection to the LAN without any previous instrument configuration.

If DHCP is not supported, enter the address information manually (static address).

Note: Risk of network errors. Connection errors can affect the entire network. If your network does not support DHCP, or if you disable DHCP, make sure to assign valid address information before connecting the instrument to the LAN. To obtain a valid IP address, subnet mask, and gateway, contact your network administrator.

MAC Address

Shows the media access control address (MAC address), a physical address and a unique identifier of the instrument.

13.2 USB connection

The USB device connector is intended to connect a computer directly to the instrument. You need a VISA communication tool installed on the computer to control the instrument using remote commands.

1. Connect a USB cable to the USB mini-B connector on the right panel of the instrument, and to a computer.
2. Press the  key.
3. Select "USB/LAN".
4. Select "Interface" = "USB".
The instrument shows the connection status.
5. When the computer detects the connected instrument, the drivers are automatically installed, and a message is displayed.
The drivers are IVI drivers
6. Open the Device Manager on the computer and check if the connected instrument is shown.

13.3 Wireless LAN Connection (Option R&S RTH-K200/200US)

Using the wireless LAN option R&S RTH-K200/200US, you can control your instrument with a portable device. Thus, you can perform dangerous measurements without risk.

When the instrument is connected to the portable device, the waveform display and user interface of the R&S RTH are directly available in the web browser. All settings can be changed in the browser, no software installation is required.

There are two ways to connect via wireless LAN:

- Usually, the R&S RTH is the access point and you set up connection on the portable device.
- The R&S RTH is the client that connects to a router or access point.



As any other wireless LAN connection, also the WLAN connection between the R&S RTH and the mobile device can be disturbed by various influences, for example, interfering signals.

To enable wireless LAN

1. Press the  key.
2. Tap "Wireless LAN".
3. Only for option R&S RTH-K200: Select the "Country", where you use the instrument.
The list contains all countries where the wireless LAN option has been approved. You also can find the list in the data sheet.
4. Enable "Wireless State".
Now you can connect the instrument.

To use the instrument as access point

1. Press the  key.
2. Tap "Wireless LAN".
3. Only for option R&S RTH-K200: Select the "Country", where you use the instrument.
The list contains all countries where the wireless LAN option has been approved. You also can find the list in the data sheet.
4. Select "Wireless Mode" = "Access Point" in the "Wireless LAN" menu.
5. If you connect for the first time, change the default "Passphrase". You can also change the identifier of the instrument, the "SSID".
6. Enable "Wireless State".
7. On your portable device, set up the connection to the instrument. Select the SSID, and enter the passphrase.
The detailed procedure is described in the documentation of your portable device.

To use the instrument as client

1. Press the  key.
2. Tap "Wireless LAN".
3. Only for option R&S RTH-K200: Select the "Country", where you use the instrument.

The list contains all countries where the wireless LAN option has been approved. You also can find the list in the data sheet.

4. Select "Wireless Mode" = "Client" in the "Wireless LAN" menu.
5. Enable "Wireless State".
The "Choose Access Point" window opens.
6. Tap the "SSID" of the required router.
7. Enter the password of the required router in "Passphrase".
The connection status is shown in "Status"

Description of settings

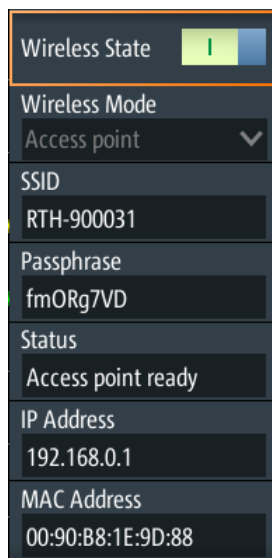

Country

Select the country, where you use the wireless LAN. The list contains all countries where the wireless LAN option has been approved.

Only available in option R&S RTH-K200.

Wireless State

Enables or disables wireless LAN access.

Wireless Mode

Selects the wireless LAN function of the instrument. It can serve as access point or as client.

Remote command:

[SYSTem:COMMunicate:WLAN:MODE](#) on page 438

SSID

Shows the wireless LAN identifier of the instrument. You can change the identifier.

Passphrase

Shows the wireless LAN password of the instrument. You can change the password.

Status

Shows the connection status and activities.

IP Address

Shows the IP address of the instrument. You need this address to set up connection on the portable device.

MAC Address

Shows the media access control address (MAC address), a physical address and unique identifier of the instrument.

13.4 Web Interface (Option R&S RTH-K201)

If the R&S RTH is connected to a computer via LAN or WLAN (with option R&S RTH-K200/200US), you can operate the instrument from the computer. No additional tools are required, you need only a web browser that supports HTML5. Thus, you can use your smartphone or tablet to operate the oscilloscope remotely.

1. Open a web browser on the computer or mobile device.
2. Type the instrument's host name or IP address in the address field of the browser, for example, *http://10.133.10.203*.

The instrument's homepage is shown.

Using the web interface, you can:

- Display a screenshot of the current instrument display.
- Operate the instrument using the menus on the emulated display. This view is designed for small devices, for example, smartphones.
- Operate the instrument using the emulated front panel. You see a live image of the instrument. You can use the keys, the wheel and the menus in the same way as directly on the instrument.
- Organize the data that is saved on the instrument. You can download files to the computer, upload files to the instrument, delete and rename files, and create folders.



The instrument is connected to the Web interface using http. Encrypted access using https is not available. The usual risks of unsecured web connection exist also to the connection of the R&S RTH.

14 Remote Control Commands

14.1 Conventions used in Command Description

Note the following conventions used in the remote command descriptions:

- **Command usage**
If not specified otherwise, commands can be used both for setting and for querying parameters.
If a command can be used for setting or querying only, or if it initiates an event, the usage is stated explicitly.
- **Parameter usage**
If not specified otherwise, a parameter can be used to set a value and it is the result of a query.
Parameters required only for setting are indicated as **Setting parameters**.
Parameters required only to refine a query are indicated as **Query parameters**.
Parameters that are only returned as the result of a query are indicated as **Return values**.
- **Conformity**
Commands that are taken from the SCPI standard are indicated as **SCPI confirmed**. All commands used by the R&S RTH follow the SCPI syntax rules.
- **Asynchronous commands**
A command which does not automatically finish executing before the next command starts executing (overlapping command) is indicated as an **Asynchronous command**.
- **Reset values (*RST)**
Default parameter values that are used directly after resetting the instrument (*RST command) are indicated as ***RST** values, if available.
- **Default unit**
This is the unit used for numeric values if no other unit is provided with the parameter.

14.2 Mode

OP[:MODE] <OperationMode>

Sets the operating mode of the instrument.

Parameters:

<OperationMode> YT | XY | MASK | ROLL | METer | FFT | LOGGer | COUNter |
 PROToCol | HARMonic | SPECtrum
 *RST: YT (scope mode)

14.3 Waveform Setup

- [Automatic Setup](#).....252
- [Vertical Setup](#).....252
- [Horizontal Setup](#).....257
- [Acquisition Control](#).....258
- [Trigger](#).....260

14.3.1 Automatic Setup

AUToscale

Performs an autoset in scope mode.

Usage: Event

14.3.2 Vertical Setup

The channel suffix <m> selects the channel for which the command is executed. The number of channels depends on the instrument type. The R&S RTH1004 has 4 channels, the suffix values are 1 | 2 | 3 | 4. The R&S RTH1002 has 2 channels, the suffix values are 1 | 2.



Set the attenuation factor of the probe manually on the display when you attach the probe: "Vertical" > "Probe Setting". There is no remote command for probe setup. Make sure to set the attenuation factor on the instrument according to the probe being used. Otherwise, the measurement results do not reflect the actual voltage level, and you might misjudge the actual risk.

- [CHANnel<m>:STATe](#).....252
- [CHANnel<m>:SCALE](#).....253
- [CHANnel<m>:RANGE](#).....253
- [CHANnel<m>:POSition](#).....253
- [CHANnel<m>:OFFSet](#).....254
- [CHANnel<m>:COUPling](#).....254
- [CHANnel<m>:BANDwidth](#).....254
- [CHANnel<m>:DESKew](#).....255
- [CHANnel<m>:THReshold:TECHnology](#).....255
- [CHANnel<m>:THReshold:USER](#).....256
- [CHANnel<m>:THReshold:THReshold?](#).....256
- [CHANnel<m>:THReshold:FINDlevel](#).....257

CHANnel<m>:STATe <State>

Switches the channel signal on or off.

Suffix:
 <m> 1|2 (RTH1002) , 1..4 (RTH1004)

Parameters:
 <State> ON | OFF
 *RST: OFF

CHANnel<m>:SCALE <Scale>

Sets the vertical scale (vertical sensitivity) of the indicated waveform.

Suffix:
 <m> 1|2 (RTH1002) , 1..4 (RTH1004)

Parameters:
 <Scale> Scale value, given in Volts per division
 Range: 2E-3 to 100
 Increment: 1E-3
 *RST: 0.05
 Default unit: V/div

CHANnel<m>:RANGe <Range>

Sets the voltage range across the 8 vertical divisions of the diagram. Use the command alternatively to [CHANnel<m>:SCALE](#).

Suffix:
 <m> 1|2 (RTH1002) , 1..4 (RTH1004)

Parameters:
 <Range> Voltage range value
 Range: 0 to 800E+3
 Increment: 10E-6
 *RST: 0
 Default unit: V

CHANnel<m>:POSition <Position>

Moves the selected signal up or down in the diagram. The position is a graphical setting given in divisions, while the offset sets a voltage.

Suffix:
 <m> 1|2 (RTH1002) , 1..4 (RTH1004)

Parameters:
 <Position> Position value, given in divisions.
 Range: -4 to 4
 Increment: 0.5
 *RST: 0
 Default unit: div

CHANnel<m>:OFFSet <Offset>

Sets an offset voltage that is added to correct an offset-affected signal. The value is included in measurement results. The signal is shifted in relation to the ground level by the offset value. Negative offset values move the waveform down, positive values move it up.

Suffix:

<m> 1|2 (RTH1002) , 1..4 (RTH1004)

Parameters:

<Offset> Range: -400 to 400
 Increment: 0.5
 *RST: 0
 Default unit: V

CHANnel<m>:COUPling <Coupling>

Selects the connection of the indicated channel.

Suffix:

<m> 1|2 (RTH1002) , 1..4 (RTH1004)

Parameters:

<Coupling> DCLimit | ACLimit

DCLimit

The signal passes the input unchanged.

ACLimit

A high-pass filter removes the DC offset voltage from the input signal if the DC component of a signal is of no interest.

*RST: DCLimit

CHANnel<m>:BANDwidth <BandwidthLimit>

Selects the bandwidth limit for the indicated channel.

Suffix:

<m> 1|2 (RTH1002) , 1..4 (RTH1004)

Parameters:

<BandwidthLimit> FULL | B350 | B200 | B100 | B60 | B50 | B40 | B20 | B10 | B5 | B4 | B2 | B1 | B5HK | B4HK | B2HK | B1HK | B50K | B40K | B20K | B10K | B5K | B4K | B2K | B1K

FULL

At full bandwidth, all frequencies in the specified range are acquired and displayed.

B350 | B200 | B100 | B60 | B50 | B40 | B20 | B10 | B5 | B4 | B2 | B1

Limit to 350 MHz, 200 MHz, 100 MHz, 60 MHz,...., respectively.

B5HK | B4HK | B2HK | B1HK | B50K | B40K | B20K | B10K | B5K | B4K | B2K | B1K

Limit to 500 kHz, 400 kHz,...., respectively.

*RST: FULL

CHANnel<m>:DESKew <Deskew>

Sets a delay for the selected channel.

Deskew compensates delay differences between channels caused by the different length of cables, probes, and other sources.

Suffix:

<m> 1|2 (RTH1002) , 1..4 (RTH1004)

Parameters:

<Deskew> Deskew value
 Range: -100E-9 to 100E-9
 Increment: 800E-12
 *RST: 0
 Default unit: s

CHANnel<m>:THReshold:TECHnology <ThresholdType>

Sets the threshold value for digitization of analog signals. If the signal value is higher than the threshold, the signal state is high (1 or true for the boolean logic). Otherwise, the signal state is considered low (0 or false) if the signal value is below the threshold.

Suffix:

<m> 1|2 (RTH1002) , 1..4 (RTH1004)

Parameters:

<ThresholdType> TTL | ECL | CMOS | CAN | GND | LIN7vsupply | LIN12vsupply | LIN18vsupply | USER

TTL

1.4 V

ECL

-1.3 V

CMOS

2.5 V

GND

0 V (for CAN channels, requires option R&S RTH-K3)

CAN

2 V (for CAN channels, requires option R&S RTH-K3)

LIN7vsupply | LIN12vsupply | LIN18vsupply

7 V / 12 V / 18 V (for LIN channels, requires option R&S RTH-K3)

USER

Set the value with `CHANnel<m>:THReshold:USER`.

*RST: TTL

CHANnel<m>:THReshold:USER <ThresholdValue>

Set an individual threshold value if `CHANnel<m>:THReshold:TECHnology` is set to USER.

Suffix:

<m> 1|2 (RTH1002) , 1..4 (RTH1004)

Parameters:

<ThresholdValue> Range: -400 to 400
Increment: 1E-3
*RST: 1.4
Default unit: V

CHANnel<m>:THReshold:THReshold?

Returns the threshold value.

Suffix:

<m> 1|2 (RTH1002) , 1..4 (RTH1004)

Return values:

<Level> Range: -10 to 10
Increment: 1E-3
*RST: 0
Default unit: V

Usage: Query only

CHANnel<m>:THReshold:FINDlevel

The instrument sets the threshold for the selected channel.

Suffix:

<m> 1|2 (RTH1002) , 1..4 (RTH1004)

Usage: Event

14.3.3 Horizontal Setup

TIMebase:SCALE	257
TIMebase:RANGe	257
TIMebase:HORizontal:POSition	257
TIMebase:REFerence	258
ACQuire:POINts:ARATe?	258

TIMebase:SCALE <Scale>

Sets the time scale of the horizontal axis for all signals.

Parameters:

<Scale> Range: 1E-9 to 500
 Increment: Steps 1, 2, 5 (1, 2, 5, 10, 20, 50, 100, 200, 500...)
 *RST: 100E-9
 Default unit: s/div

TIMebase:RANGe <AcquisitionTime>

Sets the acquisition time, the timerange across the 10 horizontal divisions of the diagram. Use the command alternatively to [TIMebase:SCALE](#).

Parameters:

<AcquisitionTime> Range: 10E-9 to 5000
 Increment: Steps 1, 2, 5 (1, 2, 5, 10, 20, 50, 100, 200, 500...)
 *RST: 1E-6
 Default unit: s

TIMebase:HORizontal:POSition <Position>

Sets the horizontal position of the trigger point in relation to the reference point.

See also: "[Horizontal Position](#)" on page 43

Parameters:

<Position> Range: Depends on the time scale, see table below.
 Increment: 0.1
 *RST: 0
 Default unit: s

Time scale	Min./max. horizontal position
1 ns/div to 100 µs/div	±2 s
200 µs/div to 2 s/div	<i>Time scale * 20000</i>
5 s/div – 500 s/div	100000 s

TIMEbase:REFerence <ReferencePoint>

Defines the time reference point in the diagram.

Parameters:

<ReferencePoint> Position of the reference point in percent of the screen width.
 Available values are:
 10: on the left side of the screen
 50: in the middle of the screen
 90: on the right side
 *RST: 50
 Default unit: %

ACQUIRE:POINTS:ARATE?

Returns the number of recorded analog waveform points per second.

Return values:

<ADCSampleRate> Range: 1.25E+9 to 5E+9
 Increment: 1
 *RST: 1.25E+9
 Default unit: Sa/s

Usage: Query only

14.3.4 Acquisition Control

RUN..... 258
 STOP..... 259
 ACQUIRE:MODE..... 259
 ACQUIRE:AVERage:COUNT..... 259
 ACQUIRE:ARESet:IMMediate..... 259
 ACQUIRE:POINTS[:VALue]?..... 260
 ACQUIRE:RESolution?..... 260

RUN

Starts the continuous acquisition.

Usage: Event

STOP

Stops the running acquisition.

Usage: Event

ACQUIRE:MODE <AcquisitionMode>

Defines how the waveform is built from the captured samples.

Parameters:

<AcquisitionMode> SAMPLE | PDETECT | HRESOLUTION | AVERAGE | ENVELOPE

SAMPLE

One of n samples in a sample interval is recorded as waveform point, the other samples are discarded.

PDETECT

The minimum and the maximum of n samples are recorded as waveform points, the other samples are discarded.

HRESOLUTION

The average of n captured sample points is recorded as one waveform point.

AVERAGE

The average is calculated from the data of the current acquisition and a number of acquisitions before. The number of acquisitions for average calculation is defined with **ACQUIRE: AVERAGE:COUNT**.

ENVELOPE

The minimum and maximum values in an sample interval over a number of acquisitions are saved. The most extreme values of all acquisitions build the envelope.

*RST: SAMPLE

ACQUIRE:AVERAGE:COUNT <NoOfAvs>

Sets the number of waveforms used to calculate the average waveform.

Parameters:

<NoOfAvs> Range: 2 to 8192
 Increment: 2^N (N = 1 .. 13)
 *RST: 2

ACQUIRE:ARESET:IMMEDIATE

Restarts the envelope and average calculation.

Usage: Event

ACQUIRE:POINTS[:VALUE]?

Returns the record length, number of recorded waveform samples.

Return values:

<RecordLength> Range: 1 to 4294967295
 Increment: 1
 *RST: 1

Usage: Query only

ACQUIRE:RESOLUTION?

Returns the resolution, the time between two waveform samples.

Return values:

<ResolutionPP> Range: 1E-12 to 1E+12
 Increment: 1E-12
 *RST: 0
 Default unit: s

Usage: Query only

14.3.5 Trigger

- [General Trigger Settings](#).....260
- [Edge Trigger](#).....264
- [Glitch Trigger](#).....264
- [Width Trigger](#).....265
- [Video/TV Trigger](#).....267
- [External Trigger \(R&S RTH1002\)](#).....270
- [Pattern Trigger \(R&S RTH-K19\)](#).....271
- [State Trigger \(R&S RTH-K19\)](#).....273
- [Runt Trigger \(R&S RTH-K19\)](#).....274
- [Slew Rate Trigger \(R&S RTH-K19\)](#).....277
- [Data2Clock Trigger \(R&S RTH-K19\)](#).....279
- [Serial Pattern Trigger \(R&S RTH-K19\)](#).....280
- [Timeout Trigger \(R&S RTH-K19\)](#).....282
- [Interval Trigger \(R&S RTH-K19\)](#).....282
- [Window Trigger \(R&S RTH-K19\)](#).....284

14.3.5.1 General Trigger Settings

See also: [Chapter 2.5.1, "General Trigger Settings"](#), on page 46

- [TRIGger:MODE](#).....261
- [TRIGger:SOURce](#).....261
- [TRIGger:TYPE](#).....261
- [TRIGger:LEVel<m>:VALue](#).....262
- [TRIGger:HOLDoff:MODE](#).....262

TRIGger:HOLDoff:TIME.....	263
TRIGger:HOLDoff:EVENTs.....	263
TRIGger:HOLDoff:MIN.....	263
TRIGger:HOLDoff:MAX.....	263
TRIGger:MNR.....	264

TRIGger:MODE <Mode>

The trigger mode determines the behavior of the instrument if no trigger occurs, and also the number of acquired waveforms when a trigger occurs.

Parameters:

<Mode> AUTO | NORMAl | SINGle

AUTO

The instrument triggers repeatedly after a time interval if the trigger conditions are not fulfilled. If a real trigger occurs, it takes precedence.

NORMAl

The instrument acquires waveforms continuously, each time when a trigger occurs.

SINGle

When a trigger occurs, the instrument acquires one waveform.

*RST: AUTO

TRIGger:SOURce <Source>

Selects the trigger source, the waveform on which the trigger condition is checked.

Parameters:

<Source> C1 | C2 | C3 | C4 | D0 | D1 | D2 | D3 | D4 | D5 | D6 | D7

Logic channels D0..D7 require option R&S RTH-B1. For video, runt, slew rate and window trigger, only analog channels are available.

*RST: C1

TRIGger:TYPE <Type>

Selects the trigger type, the event type that defines the trigger point.

Parameters:

<Type> EDGE | GLITch | WIDTH | TV | PATtern | STATe | RUNT | SLEWrate | DATatoclock | SERPattern | TIMEout | INTerval | WINDow | PROTOcol

EDGE | GLITch | WIDTH | TV

Standard trigger types

PATtern | STATe | RUNT | SLEWrate | DATatoclock | SER-Pattern | TIMEout | INTerval | WINDow

Require option R&S RTH-K19

PROTOcol

Requires option R&S RTH-K1 and/or R&S RTH-K2

*RST: EDGE

TRIGger:LEVel<m>:VALue <Level>

Sets the trigger level voltage. The command is relevant for all trigger types that require one trigger level.

Suffix:

<m> 1..21
 Indicates the trigger source:
 1..4: analog channels 1 to 4
 8..15: digital channels D0 to D7
 all others: not available

Parameters:

<Level> Range: -10 to 10
 Increment: 1E-3
 *RST: 0
 Default unit: V

TRIGger:HOLDoff:MODE <Mode>

Selects the method to define the holdoff.

Parameters:

<Mode> OFF | TIME | RANDom | EVENts

OFF

No holdoff

TIME

Defines the holdoff as a time period. The next trigger occurs only after a time has passed, which is defined with `TRIGger:HOLOff:TIME`.

RANDom

Defines the holdoff as a random time limited by `TRIGger:HOLOff:MIN` and `TRIGger:HOLOff:MAX`. For each acquisition, the instrument selects a new random holdoff time from the specified range.

EVENts

Defines the holdoff as a number of trigger events, which is defined with `TRIGger:HOLOff:EVENts`.

*RST: OFF

TRIGger:HOLOff:TIME <Time>

Sets the time that has to pass at least until the next trigger occurs. The command takes effect if `TRIGger:MODE` is set to `TIME`.

Parameters:

<Time> Range: 8E-9 to 10
 Increment: 200E-6
 *RST: 1E-3
 Default unit: s

TRIGger:HOLOff:EVENts <Events>

Sets the number of triggers to be skipped until the next trigger occurs. The command takes effect if `TRIGger:MODE` is set to `EVENts`.

Parameters:

<Events> Range: 1 to 1000000000
 Increment: 10
 *RST: 1

TRIGger:HOLOff:MIN <RandomMinTime>**TRIGger:HOLOff:MAX <RandomMaxTime>**

Set the time limits for random holdoff time. For each acquisition, the instrument selects a new random holdoff time from the specified range.

Parameters:

<RandomMinTime> Range: 8E-9 to 10
 <RandomMaxTime> Increment: 200E-6
 *RST: 2E-3
 Default unit: s

TRIGger:MNR <MoreNoiseReject>



Enables a hysteresis to avoid unwanted trigger events caused by noise oscillation around the trigger level.

Parameters:

<MoreNoiseReject> ON | OFF
 *RST: OFF

14.3.5.2 Edge Trigger**TRIGger:EDGE:SLOPe** <Slope>

Sets the edge direction for the trigger. You can trigger on:

-  Rising edge, that is a positive voltage change
-  Falling edge, that is a negative voltage change
-  Rising and falling edge

Parameters:

<Slope> POSitive | NEGative | EITHer
 *RST: POSitive

14.3.5.3 Glitch Trigger

See also: [Chapter 2.5.3, "Glitch Trigger"](#), on page 50

TRIGger:GLITch:POLarity.....	264
TRIGger:GLITch:RANGe.....	265
TRIGger:GLITch:WIDTh.....	265

TRIGger:GLITch:POLarity <Polarity>

Sets the pulse polarity, that is the direction of the first pulse slope. You can trigger on:

- Positive going pulses. The width is defined from the rising to the falling edge.
- Negative going pulses. The width is defined from the falling to the rising edge.
- Both positive and negative going pulses

Parameters:

<Polarity> POSitive | NEGative | EITHer
 *RST: POSitive

TRIGger:GLITch:RANGe <Condition>

Selects the glitches to be identified: shorter or longer than the width specified with `TRIGger:GLITch:WIDTh`.

Parameters:

<Condition> LONGer | SHORter
*RST: LONGer

TRIGger:GLITch:WIDTh <Duration>

Sets the pulse width of the glitch.

Parameters:

<Duration> Range: 800E-12 to 10000
 Increment: 100E-9
*RST: 5E-9
Default unit: s

14.3.5.4 Width Trigger

See also [Chapter 2.5.4, "Width Trigger"](#), on page 51.

<code>TRIGger:WIDTh:POLarity</code>	265
<code>TRIGger:WIDTh:RANGe</code>	265
<code>TRIGger:WIDTh:WIDTh</code>	266
<code>TRIGger:WIDTh:DELTA</code>	266
<code>TRIGger:WIDTh:MAX</code>	266
<code>TRIGger:WIDTh:MIN</code>	267

TRIGger:WIDTh:POLarity <Polarity>

Sets the pulse polarity, that is the direction of the first pulse slope. You can trigger on:

- Positive going pulses. The width is defined from the rising to the falling edge.
- Negative going pulses. The width is defined from the falling to the rising edge.
- Both positive and negative going pulses

Parameters:

<Polarity> POSitive | NEGative | EITHer
*RST: POSitive

TRIGger:WIDTh:RANGe <Condition>

Defines how the measured pulse width is compared with the given limit(s).

Parameters:

<Condition> LONGer | SHORter | EQUal | NEQual | WITHin | OUTSide

LONGer | SHORter

Triggers on pulses shorter or longer than a width set using [TRIGger:WIDTh:WIDTh](#).

EQUal | NEQual

Triggers on pulses equal or not equal a given width that is set using [TRIGger:WIDTh:WIDTh](#). In addition, a tolerance can be set around the specified width using [TRIGger:WIDTh:DELTA](#).

WITHin | OUTSide

Triggers on pulses inside or outside a given range. The range is set using [TRIGger:WIDTh:MIN](#) and [TRIGger:WIDTh:MAX](#).

*RST: LONGer

TRIGger:WIDTh:WIDTh <Duration>

Sets the width for comparison ranges EQUal, UNEQual, SHORter, and LONGer.

See [TRIGger:WIDTh:RANGe](#) on page 265

Parameters:

<Duration> Range: 800E-12 to 10000
 Increment: 100E-9
 *RST: 5E-9
 Default unit: s

TRIGger:WIDTh:DELTA <Tolerance>

Sets a range Δt to the specified width, which is defined using [TRIGger:WIDTh:WIDTh](#).

Parameters:

<Tolerance> Range: 0 to 5000
 Increment: 500E-12
 *RST: 0
 Default unit: s

TRIGger:WIDTh:MAX <MaxDuration>

Sets the upper limit for the pulse width if [TRIGger:WIDTh:RANGe](#) is set to WITHin or OUTSide.

Parameters:

<MaxDuration> Range: 800E-12 to 10000
 Increment: 100E-9
 *RST: 5E-9
 Default unit: s

TRIGger:WIDTh:MIN <MinDuration>

Sets the lower limit for the pulse width if **TRIGger:WIDTh:RANGe** is set to **WIDHIn** or **OUTSide**.

Parameters:

<MinDuration> Range: 800E-12 to 10000
 Increment: 100E-9
 *RST: 5E-9
 Default unit: s

14.3.5.5 Video/TV Trigger

The standards PAL, PAL-M, NTSC and SECAM are available in the instrument firm-ware. All other standards and custom signals require the advanced trigger option (R&S RTH-K19).

TRIGger:TV:STANdard.....	267
TRIGger:TV:POLarity.....	268
TRIGger:TV:MODE.....	268
TRIGger:TV:LINE.....	269
TRIGger:TV:LFIeld.....	269
TRIGger:TV:CUSTom:STYPe.....	269
TRIGger:TV:CUSTom:LDURation.....	270
TRIGger:TV:CUSTom:SDURation.....	270
TRIGger:TV:CUSTom:SCANmode.....	270

TRIGger:TV:STANdard <Standard>

Selects the TV standard or **CUSTom** for user-defined signals.

Parameters:

<Standard>

PAL | PALM | NTSC | SECam | P480L60HZ | P576L50HZ |
 P720L30HZ | P720L50HZ | P720L60HZ | I1080L50HZ |
 I1080L60HZ | P1080L24HZ | P1080L24HZSF | P1080L25HZ |
 P1080L30HZ | P1080L50HZ | P1080L60HZ | CUSTom

PAL | PALM | NTSC | SECam

Standards delivered with the instrument firmware.

PxxxxLyyHZ

HDTV standards using progressive scanning (P). xxxx indicates the number of active lines, yy is the frame rate.

Triggering on HDTV standards requires option R&S RTH-K19.

IxxxxLxxHZ

HDTV standards using interlaced scanning (I). xxxx indicates the number of active lines, yy is the field rate.

P1080L24HZSF

1080p/24sF is a HDTV standard using progressive segmented frame scanning.

CUSTom

Used for signals of other video systems, for example, medical displays, video monitors, and security cameras. Requires option R&S RTH-K19.

*RST: PAL

TRIGger:TV:POLarity <Polarity>

Sets the polarity of the signal. Note that the sync pulse has the opposite polarity, for example, a positive signal has a negative sync pulse.

Parameters:

<Polarity>

POSitive | NEGative

*RST: POSitive

TRIGger:TV:MODE <Mode>

Selects the lines or fields on which the instrument triggers. Available modes depend on the scanning system of the selected standard.

Parameters:

<Mode> ALL | ODD | EVEN | ALINe | LINE

ALL

All fields: Triggers on the first video line of the frame (progressive scanning) or field (interlaced scanning), for example, to find amplitude differences between the fields.

ODD | EVEN

Odd fields / even fields: Triggers on the first video line of the odd or even field. These modes are available for interlaced scanning (PAL, PAL-M, SECAM, NTSC, 1080i) and progressive segmented frame scanning (1080p/24sF). They can be used, for example, to analyze the components of a video signal.

ALINe

All lines: Triggers on the line start of all video lines, for example, to find maximum video levels.

LINE

Triggers on a specified line. Specify the line number using [TRIGger:TV:LINE](#).

*RST: ALL

TRIGger:TV:LINE <LineNumber>

Sets the number of the line to be triggered on if [TRIGger:TV:MODE](#) is LINE.

Usually the lines of the frame are counted, beginning from the frame start.

For NTSC signals, the lines are counted per field, not per frame. Therefore, you have to set the odd or even field using [TRIGger:TV:LField](#), and the line number in the field.

Parameters:

<LineNumber> Range: 1 to 3000
Increment: 1
*RST: 1

TRIGger:TV:LField <LineField>

Line field (odd or even) used as reference for counting the video lines. Used by the NTSC standard.

Parameters:

<LineField> FIELD1 | FIELD2
*RST: FIELD1

TRIGger:TV:CUSTom:STYPe <SyncPulseType>

Sets the type of the sync pulse, either bi-level sync pulse (usually used in SDTV signals), or tri-level sync pulse (used in HDTV signals).

Parameters:

<SyncPulseType> BIlevel | TRILevel
 *RST: BIlevel

TRIGger:TV:CUSTom:LDURation <LineDuration>

Sets the duration of a single video line, the time between two successive sync pulses.

Parameters:

<LineDuration> Range: 5E-6 to 200E-6
 Increment: 100E-9
 *RST: 64E-6
 Default unit: s

TRIGger:TV:CUSTom:SDURation <SyncPulseDuration>

Sets the width of the sync pulse.

Parameters:

<SyncPulseDuration> Range: 100E-9 to 100E-6
 Increment: 100E-9
 *RST: 4.7E-6
 Default unit: s

TRIGger:TV:CUSTom:SCANmode <ScanMode>

Sets the scanning system.

For details, see "Scan" on page 57.

Parameters:

<ScanMode> INTERlaced | PROGressive | SEGmented
 *RST: INTERlaced

14.3.5.6 External Trigger (R&S RTH1002)

TRIGger:EXTernal:LEVel.....270

TRIGger:EXTernal:SLOPe.....271

TRIGger:EXTernal:LEVel <Level>

Sets the trigger voltage level.

Parameters:

<Level> Range: -10 to 10
 Increment: 1E-3
 *RST: 0
 Default unit: V

TRIGger:EXTernal:SLOPe <Slope>

Sets the edge direction for the trigger. You can trigger on the rising edge, the falling edge, or riding and falling edges of the external signal.

Parameters:

<Slope> POSitive | NEGative | EITHER
*RST: POSitive

14.3.5.7 Pattern Trigger (R&S RTH-K19)

See also [Chapter 2.5.7, "Pattern Trigger \(R&S RTH-K19\)"](#), on page 58.

TRIGger:PATtern:STATe[:CHANnel<m>].....	271
TRIGger:PATtern:STATe:COMBination.....	271
TRIGger:PATtern:WIDTh:RANGe.....	272
TRIGger:PATtern:TIMeout[:TIME].....	272
TRIGger:PATtern:WIDTh[:WIDTh].....	272
TRIGger:PATtern:WIDTh:DELTA.....	273
TRIGger:PATtern:WIDTh:MINWidth.....	273
TRIGger:PATtern:WIDTh:MAXWidth.....	273

TRIGger:PATtern:STATe[:CHANnel<m>] <State>

Sets the state of each input channel. The channel is specified by the channel suffix:

The logical combination of the channel states is defined by [TRIGger:PATtern:STATe:COMBination](#).

Suffix:

<m> 1..4: analog channel 1 to 4
 8..15: digital channels D0 to D7

Parameters:

<State> ONE | ZERO | DONTcare

ONE

The signal value is above the defined threshold.

ZERO

The signal value is below the defined threshold.

DONTcare

The signal state does not matter.

*RST: DONTcare

TRIGger:PATtern:STATe:COMBination <ChCombination>

Sets the logical combination for all active channels. The required state of each channel is defined by [TRIGger:STATe:CHANnel<m>](#).

Parameters:

<ChCombination> AND | OR
 *RST: AND

TRIGger:PATtern:WIDTh:RANGe <Condition>

Adds additional time limitation to the pattern defined by `TRIGger:PATtern:STATe[:CHANnel<m>]` and `TRIGger:PATtern:STATe:COMBination`.

Parameters:

<Condition> ANY | TIMEout | LONGer | SHORter | EQUal | NEQual |
 WITHin | OUTSide

ANY

Triggers on all runts fulfilling the level condition, without time limitation.

Triggers if the signals match the pattern definition for a minimum time, which is specified by `TRIGger:PATtern:TIMEout[:TIME]`.

LONGer | SHORter

Triggers on pulses shorter or longer than a runt width that is defined by `TRIGger:RUNT:WIDTh`.

EQUal | NEQual

Triggers pulses with a width equal or unequal to a given width and an optional tolerance defined by `TRIGger:RUNT:WIDTh` and `Runt Width`

WITHin | OUTSide

Triggers on pulses inside or outside a given range. The range is defined by ..

*RST: LONGer

TRIGger:PATtern:TIMEout[:TIME] <Time>

Sets a minimum time during which the signals match the pattern definition defined by `TRIGger:PATtern:STATe[:CHANnel<m>]` and `TRIGger:PATtern:STATe:COMBination`.

The command is required if `TRIGger:PATtern:WIDTh:RANGe` is set to TIMEout.

Parameters:

<Time> Range: 100E-12 to 10000
 Increment: 100E-9
 *RST: 5E-9
 Default unit: s

TRIGger:PATtern:WIDTh[:WIDTh] <Duration>

Sets the width for comparison ranges LONGer, SHORter, EQUal and NEQual.

See [TRIGger:PATtern:WIDTh:RANGe](#) on page 272.

Parameters:

<Duration> Range: 800E-12 to 10000
 Increment: 100E-9
 *RST: 5E-9
 Default unit: s

TRIGger:PATtern:WIDTh:DELTA <Tolerance>

Sets a range Δt to the pattern width that is defined by [TRIGger:PATtern:WIDTh\[:WIDTh\]](#).

Parameters:

<Tolerance> Range: 0 to 5000
 Increment: 500E-12
 *RST: 0
 Default unit: s

TRIGger:PATtern:WIDTh:MINWidth <MinDuration>

Sets the lower time limit of the pattern match for range conditions WITHin and OUT-Side.

Parameters:

<MinDuration> Range: 800E-12 to 10000
 Increment: 100E-9
 *RST: 5E-9
 Default unit: s

TRIGger:PATtern:WIDTh:MAXWidth <MaxDuration>

Sets the upper time limit of the pattern match for range conditions WITHin and OUT-Side.

Parameters:

<MaxDuration> Range: 800E-12 to 10000
 Increment: 100E-9
 *RST: 5E-9
 Default unit: s

14.3.5.8 State Trigger (R&S RTH-K19)

See also [Chapter 2.5.8, "State Trigger \(R&S RTH-K19\)"](#), on page 60.

TRIGger:STATe:CHANnel<m>	274
TRIGger:STATe:COMBination	274
TRIGger:STATe:CSOource[:VALue]	274
TRIGger:STATe:CSOource:EDGE	274

TRIGger:STATe:CHANnel<m> <State>

Sets the state of each input channel. The channel is specified by the channel suffix:

The logical combination of the channel states is defined by [TRIGger:STATe:COMBination](#).

Suffix:

<m> 1..4: analog channel 1 to 4
 8..15: digital channels D0 to D7

Parameters:

<State> ONE | ZERO | DONTcare

ONE

The signal value is above the defined threshold.

ZERO

The signal value is below the defined threshold.

DONTcare

The signal state does not matter.

*RST: DONTcare

TRIGger:STATe:COMBination <ChCombination>

Sets the logical combination for all active channels. The required state of each channel is defined by [TRIGger:PATtern:STATe\[:CHANnel<m>\]](#).

Parameters:

<ChCombination> AND | OR

*RST: AND

TRIGger:STATe:CSOource[:VALue] <Source>

Sets the input channel of the clock signal.

Parameters:

<Source> C1 | C2 | C3 | C4 | D0 | D1 | D2 | D3 | D4 | D5 | D6 | D7

*RST: C1

TRIGger:STATe:CSOource:EDGE <Slope>

Sets the edge of the clock at which the instrument checks the signal states.

Parameters:

<Slope> POSitive | NEGative | EITHER

*RST: POSitive

14.3.5.9 Runt Trigger (R&S RTH-K19)

See also [Chapter 2.5.9, "Runt Trigger \(R&S RTH-K19\)"](#), on page 61.

TRIGger:LEVel<m>:RUNT:LOWer.....	275
TRIGger:LEVel<m>:RUNT:UPPer.....	275
TRIGger:RUNT:POLarity.....	275
TRIGger:RUNT:RANGe.....	275
TRIGger:RUNT:WIDTh.....	276
TRIGger:RUNT:DELTa.....	276
TRIGger:RUNT:MINWidth.....	276
TRIGger:RUNT:MAXWidth.....	277

TRIGger:LEVel<m>:RUNT:LOWer <LowerLevel>

TRIGger:LEVel<m>:RUNT:UPPer <UpperLevel>

Set the upper and lower levels that limit the runt.

Suffix:

<m> 1..4
 Indicates the trigger source: analog channel 1 to 4

Parameters:

<LowerLevel> Range: -10 to 10
 <UpperLevel> Increment: 1E-3
 *RST: 0
 Default unit: V

TRIGger:RUNT:POLarity <Polarity>

Sets the pulse polarity, that is the direction of the first pulse slope. You can trigger on:

- Positive going pulses. The width is defined from the rising to the falling edge.
- Negative going pulses. The width is defined from the falling to the rising edge.
- Both positive and negative going pulses

Parameters:

<Polarity> POSitive | NEGative | EITHER
 *RST: POSitive

TRIGger:RUNT:RANGe <Condition>

Defines an additional time limit of the runt pulse.

Parameters:

<Condition>	ANY LONGer SHORter EQUal NEQual WITHin OUTSide
	ANY Triggers on all runts fulfilling the level condition, without time limitation.
	LONGer SHORter Defines a minimum time during which the signals match the pattern definition. The minimum time is defined by
	EQUal NEQual Triggers on pulses equal or not equal a given runt width that is set using <code>TRIGger:RUNT:WIDTH</code> . In addition, a tolerance can be set around the specified width using <code>TRIGger:RUNT:DELTA</code> .
	WITHin OUTSide Triggers on pulses inside or outside a given range. The range is set using ... and
	*RST: LONGer

TRIGger:RUNT:WIDTH <Duration>

Sets the width for comparison ranges EQUal, UNEQual, SHORter, and LONGer.

See `TRIGger:WIDTH:RANGE`.

Parameters:

<Duration>	Range: 800E-12 to 10000
	Increment: 100E-9
	*RST: 5E-9
	Default unit: s

TRIGger:RUNT:DELTA <Tolerance>

Sets a range Δt to the specified width, which is defined using `TRIGger:RUNT:WIDTH`.

Parameters:

<Tolerance>	Range: 0 to 5000
	Increment: 500E-12
	*RST: 0
	Default unit: s

TRIGger:RUNT:MINWidth <MinDuration>

Sets the lower time limit of the runt for comparisons WITHin and OUTSide.

Parameters:

<MinDuration>	Range: 800E-12 to 10000
	Increment: 100E-9
	*RST: 5E-9
	Default unit: s

TRIGger:RUNT:MAXWidth <MaxDuration>

Sets the upper time limit of the runt for comparisons WITHin and OUTSide.

Parameters:

<MaxDuration> Range: 800E-12 to 10000
 Increment: 100E-9
 *RST: 5E-9
 Default unit: s

14.3.5.10 Slew Rate Trigger (R&S RTH-K19)

See also [Chapter 2.5.10, "Slew Rate Trigger \(R&S RTH-K19\)"](#), on page 63.

TRIGger:LEVel<m>:SLEW:LOWer.....	277
TRIGger:LEVel<m>:SLEW:UPPer.....	277
TRIGger:SLEW:SLOPe.....	277
TRIGger:SLEW:RANGe.....	277
TRIGger:SLEW:RATE.....	278
TRIGger:SLEW:DELTA.....	278
TRIGger:SLEW:MINWidth.....	278
TRIGger:SLEW:MAXWidth.....	279

TRIGger:LEVel<m>:SLEW:LOWer <Level>**TRIGger:LEVel<m>:SLEW:UPPer** <Level>

Set the upper and lower voltage thresholds, respectively. The time measurement starts when the signal crosses the first trigger level - the upper or lower level depending on the selected slope - and stops when the signal crosses the second level.

Suffix:

<m> 1..4
 Indicates the trigger source: analog channel 1 to 4

Parameters:

<Level> Range: -10 to 10
 Increment: 1E-3
 *RST: 0
 Default unit: V

TRIGger:SLEW:SLOPe <Slope>

Sets the edge direction for the trigger.

Parameters:

<Slope> POSitive | NEGative | EITHer
 *RST: POSitive

TRIGger:SLEW:RANGe <Condition>

Defines the time limits of the slew rate.

Parameters:

<Condition> LONGer | SHORter | EQUal | NEQual | WITHin | OUTSide

LONGer | SHORter
Triggers on pulses shorter or longer than a runt width that is set using [TRIGger:SLEW:RATE](#).

EQUal | NEQual
Triggers on pulses equal or not equal a given runt width that is set using [TRIGger:SLEW:RATE](#). In addition, a tolerance can be set around the specified width using [TRIGger:RUNT:DELTA](#).

WITHin | OUTSide
Triggers on pulses inside or outside a given range. The range is set using ... and

*RST: LONGer

TRIGger:SLEW:RATE <Duration>

Sets the slew rate for comparison ranges EQUal, UNEQual, SHORter, and LONGer.

See [TRIGger:SLEW:RANGe](#).

Parameters:

<Duration> Range: 800E-12 to 10000
Increment: 100E-9
*RST: 5E-9
Default unit: s

TRIGger:SLEW:DELTA <Tolerance>

Sets a range Δt to the specified slew rate, which is defined using [TRIGger:SLEW:RATE](#).

Parameters:

<Tolerance> Range: 0 to 5000
Increment: 500E-12
*RST: 0
Default unit: s

TRIGger:SLEW:MINWidth <MinDuration>

Sets the lower time limit of the transition time for comparisons WITHin and OUTSide.

Parameters:

<MinDuration> Range: 800E-12 to 10000
Increment: 100E-9
*RST: 5E-9
Default unit: s

TRIGger:SLEW:MAXWidth <MaxDuration>

Sets the upper time limit of the transition time for comparisons WITHin and OUTSide.

Parameters:

<MaxDuration> Range: 800E-12 to 10000
 Increment: 100E-9
 *RST: 5E-9
 Default unit: s

14.3.5.11 Data2Clock Trigger (R&S RTH-K19)

See also [Chapter 2.5.11, "Data2Clock Trigger \(R&S RTH-K19\)"](#), on page 64.

TRIGger:DATatoclock:DSOURCE[:VALue].....	279
TRIGger:DATatoclock:CSOURCE[:VALue].....	279
TRIGger:DATatoclock:CSOURCE:EDGE.....	279
TRIGger:DATatoclock:CONDition.....	279
TRIGger:DATatoclock:HTIME.....	280
TRIGger:DATatoclock:STIME.....	280

TRIGger:DATatoclock:DSOURCE[:VALue] <Source>

Selects the input channel of the data signal.

Parameters:

<Source> C1 | C2 | C3 | C4 | D0 | D1 | D2 | D3 | D4 | D5 | D6 | D7
 *RST: C1

TRIGger:DATatoclock:CSOURCE[:VALue] <Source>

Selects the input channel of the clock signal.

Parameters:

<Source> C1 | C2 | C3 | C4 | D0 | D1 | D2 | D3 | D4 | D5 | D6 | D7
 *RST: C1

TRIGger:DATatoclock:CSOURCE:EDGE <Slope>

Sets the edge of the clock signal: rising (POSitive), falling (NEGative), or both edges (EITHer). The time reference point for the setup and hold time is the crossing point of the clock edge and the trigger level.

Parameters:

<Slope> POSitive | NEGative | EITHer
 *RST: POSitive

TRIGger:DATatoclock:CONDition <TrigCondition>

Selects how a violation of the setup and hold time is handled.

Parameters:

<TrigCondition> VIOLation | OK
VIOLation
 Triggers on a violation of the setup or hold time
OK
 Triggers if setup and hold time keep the limits.
 *RST: VIOLation

TRIGger:DATatoclock:HTIME <HoldTime>

Sets the minimum time after the clock edge while the data signal must stay steady.
 The hold time can be negative. In this case, the setup time has to be positive. The setup time is defined by **TRIGger:DATatoclock:STIME**.

Parameters:

<HoldTime> Range: -124E-9 to 124E-9
 Increment: 1E-9
 *RST: 1E-9
 Default unit: s

TRIGger:DATatoclock:STIME <SetupTime>

Sets the minimum time before the clock edge while the data signal must stay steady.
 The setup time can be negative. In this case, the hold time has to be positive. The setup time is defined by **TRIGger:DATatoclock:HTIME**.

Parameters:

<SetupTime> Range: -124E-9 to 124E-9
 Increment: 1E-9
 *RST: 1E-9
 Default unit: s

14.3.5.12 Serial Pattern Trigger (R&S RTH-K19)

TRIGger:SPATtern:DSource[:VALue]..... 280
 TRIGger:SPATtern:CSource[:VALue]..... 281
 TRIGger:SPATtern:CSource:EDGE.....281
 TRIGger:SPATtern:CSource:FIRStedge..... 281
 TRIGger:SPATtern:ORDer.....281
 TRIGger:SPATtern:PATtern..... 281

TRIGger:SPATtern:DSource[:VALue] <Source>

Selects the input channel of the data signal.

Parameters:

<Source> C1 | C2 | C3 | C4 | D0 | D1 | D2 | D3 | D4 | D5 | D6 | D7
 *RST: C1

TRIGger:SPATtern:CSource[:VALue] <Source>

Sets the input channel of the clock signal.

Parameters:

<Source> C1 | C2 | C3 | C4 | D0 | D1 | D2 | D3 | D4 | D5 | D6 | D7
*RST: C1

TRIGger:SPATtern:CSource:EDGE <Slope>

Sets the edge at which the data value is sampled.

Parameters:

<Slope> POSitive | NEGative | EITHer
POSitive
Rising edge
NEGative
Falling edge
EITHer
Rising and falling edges are considered (double data rate).
At double data rate, the edge at which the first bit of the pattern is sampled is defined by [TRIGger:SPATtern:CSource:FIRStedge](#).
*RST: POSitive

TRIGger:SPATtern:CSource:FIRStedge <FirstClockEdge>

Sets the edge at which the first bit of the pattern is sampled.

The command is required if [TRIGger:SPATtern:CSource:EDGE](#) is set to `Either` (double data rate).

Parameters:

<FirstClockEdge> POSitive | NEGative | EITHer
*RST: POSitive

TRIGger:SPATtern:ORDER <BitOrder>

Defines if the data words start with MSBF (most significant bit first) or LSBF (least significant bit first).

Parameters:

<BitOrder> LSBF | MSBF
*RST: MSBF

TRIGger:SPATtern:PATtern <Pattern>

Defines the serial pattern to be triggered on.

Parameters:

<Pattern> String that contains the pattern in binary format. The parameter accepts the bit value X (don't care).

Example:

```
TRIGger:SPATtern:PATtern '11001100'
TRIGger:SPATtern:PATtern '110011XX'
```

14.3.5.13 Timeout Trigger (R&S RTH-K19)

TRIGger:TIMEout:RANGe..... 282
 TRIGger:TIMEout:TIME..... 282

TRIGger:TIMEout:RANGe <TimeoutMode>

Selects the relation of the signal level to the trigger level, which is specified with `TRIGger:LEVel<m>:VALue`

Parameters:

<TimeoutMode> HIGH | LOW | EITHer
 *RST: HIGH

TRIGger:TIMEout:TIME <Time>

Sets the time limit for the timeout at which the instrument triggers.

Parameters:

<Time> Range: 100E-12 to 10000
 Increment: 100E-9
 *RST: 5E-9
 Default unit: s

14.3.5.14 Interval Trigger (R&S RTH-K19)

TRIGger:INTerval:SLOPe..... 282
 TRIGger:INTerval:RANGe..... 283
 TRIGger:INTerval:WIDTh..... 283
 TRIGger:INTerval:DELTA..... 283
 TRIGger:INTerval:MINWidth..... 283
 TRIGger:INTerval:MAXWidth..... 284

TRIGger:INTerval:SLOPe <Slope>

Sets the edge direction for the trigger. You can analyze the interval between positive edges or between negative edges.

Parameters:

<Slope> POSitive | NEGative
 *RST: POSitive

TRIGger:INTerval:RANGe <Condition>

Defines how the time range of an interval is defined.

Parameters:

<Condition> LONGer | SHORter | EQUal | NEQual | WITHin | OUTSide

LONGer | SHORter

Triggers on intervals shorter or longer than an interval that is set using **TRIGger:INTerval:WIDTh**.

EQUal | NEQual

Triggers on intervals equal or not equal a given interval width that is set using **TRIGger:INTerval:WIDTh**. In addition, a tolerance can be set around the specified width using **TRIGger:INTerval:DELTA**.

WITHin | OUTSide

Triggers on intervals inside or outside a given range. The range is set using ... and

*RST: LONGer

TRIGger:INTerval:WIDTh <Duration>

Sets the time between two pulses for comparisons EQUal, UNEQual, SHORter, and LONGer.

Parameters:

<Duration> Range: 800E-12 to 10000
Increment: 100E-9
*RST: 5E-9
Default unit: s

TRIGger:INTerval:DELTA <Tolerance>

Sets a range Δt to the specified width, which is defined using **TRIGger:INTerval:WIDTh**. The command is relevant for comparisons EQUal and UNEQual.

Parameters:

<Tolerance> Range: 0 to 5000
Increment: 500E-12
*RST: 0
Default unit: s

TRIGger:INTerval:MINWidth <MinDuration>

Sets the lower time limit of the interval for comparisons WITHin and OUTSide.

Parameters:

<MinDuration> Range: 800E-12 to 10000
 Increment: 100E-9
 *RST: 5E-9
 Default unit: s

TRIGger:INTerval:MAXWidth <MaxDuration>

Sets the upper time limit of the interval for comparisons WITHin and OUTSide.

Parameters:

<MaxDuration> Range: 800E-12 to 10000
 Increment: 100E-9
 *RST: 5E-9
 Default unit: s

14.3.5.15 Window Trigger (R&S RTH-K19)

TRIGger:LEVel<m>:WINDow:LOWer.....	284
TRIGger:LEVel<m>:WINDow:UPPer.....	284
TRIGger:WINDow:TIME.....	284
TRIGger:WINDow:RANGe.....	285
TRIGger:WINDow:WIDTh.....	285
TRIGger:WINDow:DELTA.....	286
TRIGger:WINDow:MINWidth.....	286
TRIGger:WINDow:MAXWidth.....	286

TRIGger:LEVel<m>:WINDow:LOWer <Level>

TRIGger:LEVel<m>:WINDow:UPPer <Level>

Set the upper and lower voltage thresholds for the window trigger, respectively. The trigger levels are the vertical window limits.

Suffix:

<m> 1..4
 Indicates the trigger source: analog channel 1 to 4

Parameters:

<Level> Range: -10 to 10
 Increment: 1E-3
 *RST: 0
 Default unit: V

TRIGger:WINDow:TIME <Condition>

Selects how the time limit of the window is defined.

Parameters:

<Condition> LONGer | SHORter | EQUal | NEQual | WITHin | OUTSide

LONGer | SHORter
Triggers if the signal crosses the upper or lower level after/before the time "Width" defined by `TRIGger:WINDow:WIDTh`

EQUal | NEQual
Triggers if the signal stays inside or outside the vertical window limits for a time equal/unequal to "Width" "±Tolerance" defined by `TRIGger:WINDow:WIDTh` and `TRIGger:WINDow:DELTA`.

WITHin
Triggers if the signal stays inside or outside the vertical window limits for a time \geq "Min Width" AND \leq "Max Width".

OUTSide
Triggers if the signal stays inside or outside the vertical window limits for a time $<$ "Min Width" OR $>$ "Max Width".

*RST: LONGer

TRIGger:WINDow:RANGe <LevelRangeMode>

Selects how the signal run is compared with the window:

Parameters:

<LevelRangeMode> ENTer | EXIT | WITHin | OUTSide

ENTer | EXIT
Triggers when the signal crosses the upper or lower level and thus enters/leaves the window made up of these two levels which are defined by `TRIGger:LEVel<m>:WINDow:UPPer` and `TRIGger:LEVel<m>:WINDow:LOWer`

WITHin | OUTSide
Triggers if the signal stays between/above the upper and lower level for a specified time. The time is defined by `TRIGger:WINDow:TIME`

*RST: ENTer

TRIGger:WINDow:WIDTh <Duration>

Sets the width for comparison ranges LONGer, SHORter, EQUal, NEQual.

See `TRIGger:WINDow:TIME` on page 284.

Parameters:

<Duration> Range: 800E-12 to 10000
Increment: 100E-9
*RST: 5E-9
Default unit: s

TRIGger:WINDow:DELTA <Tolerance>

Sets a range Δt to the specified width, which is defined using [TRIGger:WINDow:WIDTh](#).

Parameters:

<Tolerance> Range: 0 to 5000
 Increment: 500E-12
 *RST: 0
 Default unit: s

TRIGger:WINDow:MINWidth <MinDuration>

Sets the lower time limit of the stay inside or outside the window (comparisons WITHin and OUTSide).

Parameters:

<MinDuration> Range: 800E-12 to 10000
 Increment: 100E-9
 *RST: 5E-9
 Default unit: s

TRIGger:WINDow:MAXWidth <MaxDuration>

Sets the upper time limit of the stay inside or outside the window (comparisons WITHin and OUTSide).

Parameters:

<MaxDuration> Range: 800E-12 to 10000
 Increment: 100E-9
 *RST: 5E-9
 Default unit: s

14.4 Waveform Analysis

14.4.1 Zoom

See also [Chapter 3.1, "Zoom"](#), on page 73.

ZOOM:ENABle	286
ZOOM:SCALe	287
ZOOM:POSition	287

ZOOM:ENABLE <Enabled>

Enables or disables the zoom.

Parameters:

<Enabled> ON | OFF
 *RST: OFF

ZOOM:SCALE <Scale>

Sets the time scale of the zoomed waveform.

Depending on the recording time not all horizontal scales are available. This is due to the fact that, the zoom is always displaying a complete curve.

Parameters:

<Scale> Range: 1E-12 to 500
 Increment: 1E-12
 *RST: 100E-9
 Default unit: s

ZOOM:POSition <Position>

Sets the center position of the zoomed area in relation to the trigger point.

Parameters:

<Position> Range: -500 to 500
 Increment: 1E-12
 *RST: 0
 Default unit: s

14.4.2 Automatic Measurements

In remote commands for automatic measurements, the suffix <m> defines the measurement index. You can perform up to four different measurements simultaneously.

- [Measurement Settings](#)..... 287
- [Measurement Results](#)..... 289

14.4.2.1 Measurement Settings

MEASurement<m>:ENABLE	287
MEASurement<m>:SOURce	288
MEASurement<m>:TYPE	288
MEASurement<m>:AOFF	289
MEASurement<m>:DELay:SLOPe	289

MEASurement<m>:ENABLE <State>

Enables or disables the measurement.

Suffix:

<m> 1..4

Parameters:

<State> ON | OFF
 *RST: OFF

MEASurement<m>:SOURce <Source>, [<Source2>]

Defines the waveform to be measured. For delay, phase, and power measurements, 2 sources are required.

The sources can be any active input signal, math or reference waveform. Available source waveforms depend on the measurement type, see [Chapter 3.2.3, "Measurement Types"](#), on page 76.

Suffix:

<m> 1..4

Parameters:

<Source> C1 | C2 | C3 | C4 | M1 | R | D0 | D1 | D2 | D3 | D4 | D5 | D6 | D7
 <Source2> C1 | C2 | C3 | C4 | M1 | R | D0 | D1 | D2 | D3 | D4 | D5 | D6 | D7

MEASurement<m>:TYPE <Type>

Selects the measurement type. For a detailed description, see [Chapter 3.2.3, "Measurement Types"](#), on page 76.

Suffix:

<m> 1..4

Parameters:

<Type> PERiod | FREQuency | RTIME | FTIME | PPULse | NPULse | PDCYcle | NDCYcle | DELay | PHASe | MEAN | RMS | CREST | STDDev | MINimum | MAXimum | PKPK | BASElevel | TOPLevel | AMPLitude | OVRShoot | PREShoot | AC | DC | ACDC | PPCount | NPCount | RECount | FECount | PWRP | PWRS | PWRQ | PWRFactor
 *RST: MINimum

RTIME	Rise time	PREShoot	Preshoot
FTIME	Fall time	PPCount	Positive pulse count
PPULse	Positive pulse width	NPCount	Negative pulse count
NPULse	Negative pulse width	RECount	Rising edge count
PDCYcle	Positive duty cycle	FECount	Falling edge count
NDCYcle	Negative duty cycle	PWRP	Active power
STDDev	Standard deviation	PWRS	Apparent power
PKPK	Peak to peak	PWRQ	Reactive power
OVRShoot	Overshoot	PWRFactor	Power factor

MEASurement<m>:AOFF

Disables all active measurements.

Suffix:

<m> 1..4
The suffix is irrelevant.

Usage: Event

MEASurement<m>:DELay:SLOPe <Slope>

Sets the slope for the delay measurement type.

Suffix:

<m> 1..4

Parameters:

<Slope> POSitive | NEGative | EITHer

POSitive

Delay between the first rising edge of each source waveform.

NEGative

Delay between the first falling edge of each source waveform.

EITHer

Delay between the first edge of each source waveform, no matter if it is rising or falling.

*RST: POSitive

14.4.2.2 Measurement Results

MEASurement<m>:RESult:ACTual?

Returns the result of the indicated measurement.

Suffix:

<m> 1..4

Return values:

<Result> Range: -100E+24 to 100E+24
Increment: 100E-12
*RST: 0

Usage: Query only

MEASurement<m>:RESult:LIMit?

Indicates whether the measurement results are inside the measurement range, or outside (clipping).

Suffix:

<m> 1..4

Return values:

<ResultLimit> INSide | OVERflow | UNDeRflow | OVUNflow
 *RST: INSide

Usage: Query only

14.4.3 Cursor Measurements

The following commands are required for common R&S RTH cursor measurements. Special commands are available for Spectrum mode, see [Chapter 14.6.2.2, "Cursor Measurements in Spectrum Mode"](#), on page 311.

- [Cursor Settings](#)..... 290
- [Cursor Measurement Results](#)..... 292

14.4.3.1 Cursor Settings

[CURSor:STATe](#)..... 290
[CURSor:FUNcTion](#)..... 290
[CURSor:SOURce](#)..... 290
[CURSor:COUPling](#)..... 291
[CURSor:SCPLing](#)..... 291
[CURSor:SCReen](#)..... 291
[CURSor:MEASurement<m>:TYPE](#)..... 291

CURSor:STATe <State>

Enables or disables the cursor measurement.

Parameters:

<State> ON | OFF
 *RST: OFF

CURSor:FUNcTion <Type>

Defines the type of the cursor measurement.

Parameters:

<Type> VERTical | HORizontal | TRACking | MEASure
 See [Chapter 3.3.2, "Cursor Types and Results"](#), on page 82.
 *RST: VERTical

CURSor:SOURce <Source>

Defines the source on which the cursor measurement is performed. The source setting is not relevant for the vertical cursor type.

Parameters:

<Source> C1 | C2 | C3 | C4 | M1 | D0 | D1 | D2 | D3 | D4 | D5 | D6 | D7
 *RST: C1

CURSor:COUPLing <Coupling>

Couples the cursor lines so that the distance between the two lines remains the same if one cursor is moved.

Parameters:

<Coupling> ON | OFF
 *RST: OFF

CURSor:SCPLing <ScaleCoupling>

If ON, the position of the cursor lines is adjusted if the vertical or horizontal scales are changed. If OFF, the cursor lines remain on their position on the display if the scaling is changed.

Parameters:

<ScaleCoupling> ON | OFF
 *RST: OFF

CURSor:SCReen

Sets the cursors to a default position on the screen.

Usage: Event

CURSor:MEASurement<m>:TYPE <Type>

Sets the automatic measurements to be performed on the source waveform between the cursor lines. The setting is only available if **CURSor:FUNction** is set to **MEASure**.

Suffix:

<m> 1..2
 Defines the measurement index. Two simultaneous cursor measurements can be performed.

Parameters:

<Type> PERiod | FREQuency | RTIME | FTIME | PPULse | NPULse |
 PDCYcle | NDCYcle | MEAN | RMS | CREST | STDDev |
 MINimum | MAXimum | PKPK | BASelevel | TOPLevel |
 AMPLitude | OVRShoot | PREShoot | AC | DC | ACDC |
 PPCount | NPCount | RECount | FECount
 See **MEASurement<m>:TYPE** on page 288.
 *RST: MINimum

14.4.3.2 Cursor Measurement Results

CURSor:TDELta?	292
CURSor:ITDelta?	292
CURSor:X1Position	292
CURSor:X2Position	292
CURSor:DELTA?	292
CURSor:Y1Position	293
CURSor:Y2Position	293
CURSor:Y1Amplitude?	293
CURSor:Y2Amplitude?	293
CURSor:MEASurement<m>:RESult:ACTual?	293
CURSor:MEASurement<m>:RESult:LIMit?	293

CURSor:TDELta?

Returns the time difference Δ between to vertical cursor lines.

Return values:

<ResultDeltaT> Range: -100E+24 to 100E+24
 *RST: 0

Usage: Query only

CURSor:ITDelta?

Returns the inverse value of time difference between to vertical cursor lines $1/\Delta$.

Return values:

<ResultDeltaTInv> Range: -100E+24 to 100E+24
 Increment: 0
 *RST: 0

Usage: Query only

CURSor:X1Position <UserX1>

CURSor:X2Position <UserX2>

Set the horizontal positions t1 and t2 (time) of the vertical cursor lines.

Parameters:

<UserX1>, <UserX2> Range: -100E+24 to 100E+24
 Increment: 100E-12
 *RST: 0
 Default unit: s

CURSor:DELTA?

Returns the absolute value of the difference between the positions of horizontal cursor lines Δy .

Return values:

<ResultDelta> Range: -100E+24 to 100E+24
 *RST: 0

Usage: Query only

CURSor:Y1Position <UserY1>**CURSor:Y2Position <UserY2>**

Set the vertical positions y1 and y2 of the horizontal cursor lines.

Parameters:

<UserY1>, <UserY2> Range: -100E+24 to 100E+24
 Increment: 100E-6
 *RST: 0
 Default unit: V

CURSor:Y1AMplitude?**CURSor:Y2AMplitude?**

Return the vertical values of the crossing points between the tracking cursors and the source waveform.

Return values:

<ResultAmplitude1> Range: -100E+24 to 100E+24
 <ResultAmplitude2> *RST: 0

Usage: Query only

CURSor:MEASurement<m>:RESult:ACTual?

Returns the result of the indicated cursor measurement.

Suffix:

<m> 1..2
 Defines the measurement index. Two simultaneous cursor measurements can be performed.

Return values:

<Result> Range: -100E+24 to 100E+24
 Increment: 100E-12
 *RST: 0

Usage: Query only

CURSor:MEASurement<m>:RESult:LIMit?

Indicates whether the measurement results are inside the measurement range, or outside (clipping).

Suffix:	
<m>	1..2 Defines the measurement index. Two simultaneous cursor measurements can be performed.
Return values:	
<ResultLimit>	INSide OVERflow UNDErflow OVUNflow
	*RST: INSide
Usage:	Query only

14.4.4 Math Waveforms

14.4.4.1 Math Settings

CALCulate:MATH:STATe.....	294
CALCulate:MATH[:EXPRession][:DEFine].....	294
CALCulate:MATH:VERTical:SCALE.....	295
CALCulate:MATH:VERTical:RANGe.....	295
CALCulate:MATH:VERTical:POSition.....	295

CALCulate:MATH:STATe <State>

Enables or disables the math channel.

Parameters:

<State> ON | OFF

Usage: SCPI confirmed

CALCulate:MATH[:EXPRession][:DEFine] <ExprDefinition>

Sets the operation to calculate a math waveform.

Parameters:

<ExprDefinition> String that defines the operation. x is the channel number of source 1, y the channel number of source 2.
 Addition: 'Cx+Cy'
 Subtraction: 'Cx-Cy'
 Multiplication: 'Cx*Cy'
 Inverse: '-Cx'
 Absolute value: 'Abs(Cx)'
 Square: 'Pow(Cx)'

Example:

CALC:MATH:EXPR:DEF 'C1-C2'
 Subtracts the values of CH2 from the values of CH1.
 CALC:MATH:EXPR:DEF 'Pow(C1)'
 Squares the values of CH1.

Usage: SCPI confirmed

CALCulate:MATH:VERTical:SCALE <Scale>

Sets the vertical scale (vertical sensitivity) of the math waveform.

Parameters:

<Scale> Scale value, in V/div.

Usage: SCPI confirmed

CALCulate:MATH:VERTical:RANGE <Position>

Sets the voltage range across the 8 vertical divisions of the diagram. Use the command alternatively to [CALCulate:MATH:VERTical:SCALE](#).

Parameters:

<Position> Voltage value of the range

Usage: SCPI confirmed

CALCulate:MATH:VERTical:POSition <Position>

Moves the math waveform or down in the diagram.

Parameters:

<Position> Position value, given in divisions.

Usage: SCPI confirmed

14.4.5 Reference Waveforms

REFCurve:SOURce	295
REFCurve:UPDate	295
REFCurve:STATe	296
REFCurve:POSition	296
REFCurve:NAME	296
REFCurve:SAVE	296
REFCurve:OPEN	296
REFCurve:DELeTe	296

REFCurve:SOURce <Source>

Selects the waveform to be taken as reference waveform.

Parameters:

<Source> C1 | C2 | C3 | C4 | M1
*RST: C1

REFCurve:UPDate

Creates the reference waveform from the source waveform.

Usage: Event

REFCurve:STATe <State>

Activates or deactivates the reference waveform.

Parameters:

<State> ON | OFF

REFCurve:POSition <Position>

Sets the vertical position of the reference waveform.

Parameters:

<Position> Default unit: DIV

REFCurve:NAME <Name>

Defines the path, file name and file format of the reference waveform file.

The default path is C:/Users/<user>/Rohde-Schwarz/RTH/ReferenceCurves.

Parameters:

<Name> String

Example:

```
:REFCurve:NAME 'C:
/Users/user1/Rohde-Schwarz/RTH/ReferenceCurves/reference00
```

REFCurve:SAVE

Saves the reference waveform. The target file is specified using [REFCurve:NAME](#).

Usage: Event

REFCurve:OPEN

Loads a stored reference waveform from the specified file. The file is specified using [REFCurve:NAME](#).

Usage: Event

REFCurve:DELeTe

Deletes a stored reference waveform file. The file is specified using [REFCurve:NAME](#).

Usage: Event

14.4.6 History (Option R&S RTH-K15)

In `CHANnel:HISTory` commands, the channel suffix is irrelevant, omit it.

See also: [Chapter 3.7, "History \(Option R&S RTH-K15\)"](#), on page 92

CHANnel<m>:HISTory[:STATe].....	297
CHANnel<m>:HISTory:NSEGments.....	297
CHANnel<m>:HISTory:TPACq.....	297
ACQuire:AVAIlable?.....	298
CHANnel<m>:HISTory:START.....	298
CHANnel<m>:HISTory:STOP.....	298
CHANnel<m>:HISTory:CURRent.....	298
CHANnel<m>:HISTory:PLAY.....	299
CHANnel<m>:HISTory:REPLay.....	299
CHANnel<m>:HISTory:TSABsolute?.....	299
CHANnel<m>:HISTory:TSDate?.....	299
CHANnel<m>:HISTory:TSRRelative?.....	300

CHANnel<m>:HISTory[:STATe] <State>

Enables or disables the history function.

Suffix:

<m> Suffix is irrelevant, omit it.

Parameters:

<State> ON | OFF
 *RST: OFF

CHANnel<m>:HISTory:NSEGments <Depth>

Sets the approximate number of waveforms to be stored.

See also ["Number of Segments"](#) on page 93.

Suffix:

<m> Suffix is irrelevant, omit it.

Parameters:

<Depth> LOW | MEDium | HIGH
 *RST: LOW

CHANnel<m>:HISTory:TPACq <PlayerSpeed>

Defines how fast the history player shows the stored waveforms.

Suffix:

<m> Suffix is irrelevant, omit it.

Parameters:

<PlayerSpeed> AUTO | SLOW | MEDium | FAST
 *RST: AUTO

ACQUIRE:AVAILABLE?

Shows the number of segments that are stored in the history.

Return values:

<AvailableAcqs> Range: 0 to 5000
 Increment: 1
 *RST: 0

Usage: Query only

CHANNEL<m>:HISTORY:START <StartAcqIdx>

Sets the index of the first (older) history segment that you want to see in the history player. To query the number of available segments, use [ACQUIRE:AVAILABLE?](#)

Suffix:

<m> Suffix is irrelevant, omit it.

Parameters:

<StartAcqIdx> Range: -4999 to 0
 Increment: 1
 *RST: 0

CHANNEL<m>:HISTORY:STOP <StopAcqIdx>

Sets the index of the last (newer) history segment that you want to see in the history player. To query the number of available segments, use [ACQUIRE:AVAILABLE?](#). The newest segment has always the index "0". Older segments have a negative index.

Suffix:

<m> Suffix is irrelevant, omit it.

Parameters:

<StopAcqIdx> Range: -4999 to 0
 Increment: 1
 *RST: 0

Example:

```
CHANNEL:START -199
CHANNEL:STOP -100
```

The segments 101 (index -100) to 200 (index -199) in the history player.

CHANNEL<m>:HISTORY:CURRENT <CurrAcqIdx>

Accesses a particular segment in the memory to display it. The query returns the index of the segment that is shown.

To determine the number of stored segments, use [ACQUIRE:AVAILABLE?](#)

Suffix:

<m> Suffix is irrelevant, omit it.

Parameters:

<CurrAcqIdx> History index: the newest segment has the index "0", older segments have a negative index: -(n-1), -1 , 0
n is the number of acquired segments.

Range: 0 to -(n-1)
Increment: 1
*RST: 0

CHANnel<m>:HISTory:PLAY

Starts and stops the playback of the history segments.

Suffix:

<m> Suffix is irrelevant, omit it.

Example:

CHANnel:HISTory:PLAY; *OPC

See also [Chapter B, "Command Sequence and Synchronization"](#), on page 449.

Usage:

Event
Asynchronous command

CHANnel<m>:HISTory:REPLay <AutoRepeat>

If set to ON, the playback of the selected history segments repeats automatically.

Suffix:

<m> Suffix is irrelevant, omit it.

Parameters:

<AutoRepeat> ON | OFF
*RST: OFF

CHANnel<m>:HISTory:TSABsolute?

Returns the absolute daytime of the current segment ([CHANnel<m>:HISTory:CURRent](#)).

Suffix:

<m> Suffix is irrelevant, omit it.

Return values:

<TimeStampAbsTime>String containing the time and unit.

Usage:

Query only

CHANnel<m>:HISTory:TSDate?

Returns the date of the current segment ([CHANnel<m>:HISTory:CURRent](#)).

Suffix:

<m> Suffix is irrelevant, omit it.

Return values:

<TimeStampAbsData>String with date of the current acquisition (absolute time)

Usage: Query only

CHANnel<m>:HISTory:TSRelative?

Returns the relative time of the current segment - the time difference to the newest segment (index = 0).

See also [CHANnel<m>:HISTory:CURRent](#).

Suffix:

<m> Suffix is irrelevant, omit it.

Return values:

<TimeStampRel> String containing the relative time in seconds.

Usage: Query only

14.5 Mask Testing

14.5.1 Mask Definition

The suffix <m> selects the mask channel for which the command is executed. The number of channels depends on the instrument type. The R&S RTH1004 has 5 mask channels, the suffix values are 1 | 2 | 3 | 4 | 5. The R&S RTH1002 has 3 mask channels, the suffix values are 1 | 2 | 5. Suffix 5 is used for the mask on a math waveform.

MASK:CHANnel<m>:STATe	300
MASK:CHANnel<m>:PROPerties:XWIDth	300
MASK:CHANnel<m>:PROPerties:YWIDth	301
MASK:CHANnel<m>:CREatemask	301

MASK:CHANnel<m>:STATe <State>

Turns the selected mask on or off.

Suffix:

<m> 1|2|5 (RTH1002) , 1..5 (RTH1004)

Parameters:

<State> ON | OFF
*RST: OFF

MASK:CHANnel<m>:PROPerties:XWIDth <WidthX>

Changes the width of the selected mask in horizontal direction.

Suffix:
 <m> 1|2|5 (RTH1002) , 1..5 (RTH1004)

Parameters:
 <WidthX> Range: 0 to 10
 Increment: 0.01
 *RST: 0
 Default unit: div

MASK:CHANnel<m>:PROPerties:YWIDth <WidthY>
 Changes the width of the selected mask in vertical direction.

Suffix:
 <m> 1|2|5 (RTH1002) , 1..5 (RTH1004)

Parameters:
 <WidthY> Range: 0 to 8
 Increment: 0.01
 *RST: 0.1
 Default unit: div

MASK:CHANnel<m>:CREatemask
 Creates a mask from the envelope waveform of the selected waveform with the defined width in x and y direction.

Suffix:
 <m> 1|2|5 (RTH1002) , 1..5 (RTH1004)

Usage: Event

14.5.2 Mask Test

MASK:ONViolation[:SElection].....	301
MASK:RST.....	302
MASK[:TESTstate]?	302
MASK:CHANnel<m>:RESult:FAIL:PERCentage?	302
MASK:CHANnel<m>:RESult:FAIL[:COUNt]?	302
MASK:CHANnel<m>:RESult:PASS:PERCentage?	303
MASK:CHANnel<m>:RESult:PASS[:COUNt]?	303
MASK:CHANnel<m>:RESult:TOTL[:COUNt]?	303
MASK:ELAPsedtime:TOTal?	303
MASK:ELAPsedtime[:SECS]?	304

MASK:ONViolation[:SElection] <SelectedActions>
 Defines the action to be executed if a violation occurs.

Parameters:

<SelectedActions> NONE | STOP | BEEP | BPSTop
 *RST: NONE

MASK:RST

Sets the counters of passed and failed acquisitions to Zero.

Usage: Event

MASK[:TESTstate]?

Returns the state of the mask test.

Return values:

<TestState> NOMask | IDLE | RUNNing

NOMask

No mask is active and no testing possible.

IDLE

Mask test has been stopped or not yet started.

RUNNing

Test ist running.

*RST: NOMask

Usage: Query only

MASK:CHANnel<m>:RESult:FAIL:PERCentage?

Returns the percentage share of failed acquisitions.

Suffix:

<m> 1|2|5 (RTH1002) , 1..5 (RTH1004)

Return values:

<ResultFailed> Range: 0 to 100
 Increment: 0.1
 *RST: 0
 Default unit: %

Usage: Query only

MASK:CHANnel<m>:RESult:FAIL[:COUNT]?

Returns the number of failed acquisitions.

Suffix:

<m> 1|2|5 (RTH1002) , 1..5 (RTH1004)

Return values:

<ResultFailed> Range: 0 to 0
 Increment: 1
 *RST: 0

Usage: Query only

MASK:CHANnel<m>:RESult:PASS:PERcentage?

Returns the percentage share of passed acquisitions.

Suffix:

<m> 1|2|5 (RTH1002) , 1..5 (RTH1004)

Return values:

<PassedPercentage> Range: 0 to 100
 Increment: 0.1
 *RST: 0
 Default unit: %

Usage: Query only

MASK:CHANnel<m>:RESult:PASS[:COUNT]?

Returns the number of passed acquisitions.

Suffix:

<m> 1|2|5 (RTH1002) , 1..5 (RTH1004)

Return values:

<ResultPassed> Range: 0 to 0
 Increment: 1
 *RST: 0

Usage: Query only

MASK:CHANnel<m>:RESult:TOTL[:COUNT]?

Returns the number of tested acquisitions.

Suffix:

<m> 1|2|5 (RTH1002) , 1..5 (RTH1004)

Return values:

<ResultTotal> Range: 0 to 0
 Increment: 1
 *RST: 0

Usage: Query only

MASK:ELAPsedtime:TOTal? <Day>, <Hour>, <Min>, <Sec>

Returns the test duration.

Query parameters:

<Day>	Test time in days.
<Hour>	Test time in hours.
<Min>	Test time in minutes.
<Sec>	Test time in seconds.

Return values:

<ZSec>	Test time in deciseconds.
--------	---------------------------

Usage: Query only

MASK:ELAPsedtime[:SECS]?

Returns the test duration in seconds.

Return values:

<Sec>	Time in seconds
-------	-----------------

Usage: Query only

14.6 Spectrum Analysis

- [FFT Mode](#).....304
- [Spectrum Mode \(R&S RTH-K18\)](#).....307
- [Harmonic Mode \(R&S RTH-B34\)](#).....319

14.6.1 FFT Mode

To activate FFT mode, use `OP FFT` (see `OP [:MODE]` on page 251).

SPECTrum:SOURce	304
SPECTrum:FREQuency:BANDwidth[:RESolution][:VALue]	305
SPECTrum:FREQuency:CENTer	305
SPECTrum:FREQuency:HORizontal:SCALe	305
SPECTrum:FREQuency:MAGNitude:SCALe	305
SPECTrum:FREQuency:SAMPle?	306
SPECTrum:FREQuency:SPAN:MODE	306
SPECTrum:FREQuency:SPAN[:VALue]	306
SPECTrum:FREQuency:START	306
SPECTrum:FREQuency:STOP	307
SPECTrum:FREQuency:WINDow:FACTor?	307
SPECTrum:FREQuency:WINDow:TYPE	307

SPECTrum:SOURce <Source>

Selects the channel for which the captured data is analyzed in FFT mode.

Parameters:

<Source> C1 | C2 | C3 | C4
 *RST: C1

SPECTrum:FREQUency:BANDwidth[:RESolution][:VALue]

Queries or defines the used resolution bandwidth. The value depends on the [SPECTrum:FREQUency:SPAN:MODE](#) and [CHANnel<m>:BANDwidth](#) parameters.

In FFT mode, this command is query only.

Parameters:

<RBW> Range: 1 to 50E+9
 Increment: 1E+6
 *RST: 500E+3
 Default unit: Hz

SPECTrum:FREQUency:CENTer <HorizCenter>

Queries or defines the used center frequency. The value depends on the [SPECTrum:FREQUency:SPAN:MODE](#) and [CHANnel<m>:BANDwidth](#) parameters.

In FFT mode, this command is query-only.

Parameters:

<HorizCenter> Range: 500 to 500E+6
 Increment: 10
 *RST: 250E+6
 Default unit: Hz

SPECTrum:FREQUency:HORIZontal:SCALE <Scaling>

Defines the scaling method for the frequency (x-)axis of the spectrum display.

Parameters:

<Scaling> LINear | LOGarithmic
 *RST: LINear

SPECTrum:FREQUency:MAGNitude:SCALE <MagnitudeUnit>

Queries or defines the scale unit for the amplitude range (y-axis) in the spectrum display.

In FFT mode, this command is query-only.

Parameters:

<MagnitudeUnit> DBM | DBV | DBA
 *RST: DBM

SPECTrum:FREQuency:SAMPlE?

Queries the sample rate with which FFT analysis is performed. This command is only available in FFT mode.

Return values:

<FFTSmpFreq> Range: 1 to 10E+9
 Increment: 10
 *RST: 1
 Default unit: Hz

Usage: Query only

SPECTrum:FREQuency:SPAN:MODE <Mode>

Defines how many values are analyzed by a single FFT, and thus the frequency resolution.

Parameters:

<Mode> NARRow | MAX
 NARRow
 8k values analyzed per FFT; time scale ≥ 100 ms/div
 MAX
 64k values analyzed per FFT; time scale ≥ 1 us/div
 *RST: MAX

SPECTrum:FREQuency:SPAN[:VALue] <HorizontalSpan>

Queries or defines the used span, that is: how many values are analyzed by a single FFT.

In FFT mode, this command is query-only.

Parameters:

<HorizontalSpan> 8E+6 | 64E+6
 Range: 1000 to 500E+6
 Increment: 1
 *RST: 500E+6
 Default unit: Hz

SPECTrum:FREQuency:STARt <HorizontalStart>

Queries or defines the start frequency of the used span. The value depends on the [SPECTrum:FREQuency:SPAN:MODE](#) and [CHANnel<m>:BANDwidth](#) parameters.

In FFT mode, this command is query-only.

Parameters:

<HorizontalStart> Range: 0 to 499.999E+6
 Increment: 10
 *RST: 0
 Default unit: Hz

SPECTrum:FREQUENCY:STOP <HorizontalStop>

Queries or defines the stop frequency of the used span. The value depends on the [SPECTrum:FREQUENCY:SPAN:MODE](#) and [CHANnel<m>:BANDwidth](#) parameters.

In FFT mode, this command is query-only.

Parameters:

<HorizontalStop> Range: 1000 to 500E+6
 Increment: 10
 *RST: 500E+6
 Default unit: Hz

SPECTrum:FREQUENCY:WINDOW:FACTOR?

Queries the window factor used for FFT analysis.

Return values:

<WindowFactor> Range: 0.89 to 3.84
 Increment: 0.1
 *RST: 1.44

Usage: Query only

SPECTrum:FREQUENCY:WINDOW:TYPE <WindowType>

Determines the window function used for FFT analysis. See [Table 5-1](#) for details.

Parameters:

<WindowType> RECTangular | FLATtop | HAMMING | HANN | BLACKman
 *RST: HANN

14.6.2 Spectrum Mode (R&S RTH-K18)

To activate Spectrum mode, use `OP SPEC` (see [OP\[:MODE\]](#) on page 251).

The commands described here are specific to the Spectrum mode and require the R&S RTH-K18 option to be installed.

In addition, the following commands from the FFT mode (integrated in the base unit) are also supported:

- [SPECTrum:SOURce](#) on page 304
- [SPECTrum:FREQUENCY:HORIZontal:SCALE](#) on page 305
- [SPECTrum:FREQUENCY:CENTER](#) on page 305

- `SPECTrum:FREQuency:SPAN[:VALue]` on page 306
- `SPECTrum:FREQuency:WINDow:TYPE` on page 307
- `SPECTrum:FREQuency:MAGNitude:SCALE` on page 305

Commands specific to the Spectrum mode:

- [Configuring the Measurement](#).....308
- [Cursor Measurements in Spectrum Mode](#)..... 311
- [Markers in Spectrum Mode](#).....314
- [Exporting Spectrum Analysis Results](#)..... 318

14.6.2.1 Configuring the Measurement

`SPECTrum:MODE?`.....308

`SPECTrum:FREQuency:AVERAge:COUNT`..... 308

`SPECTrum:FREQuency:BANDwidth[:RESolution]:AUTO`..... 309

`SPECTrum:FREQuency:BANDwidth[:RESolution]:RATio`..... 309

`SPECTrum:FREQuency:FULLspan`.....309

`SPECTrum:FREQuency:MAGNitude:REFerence[:VALue]`..... 309

`SPECTrum:FREQuency:POSition`.....310

`SPECTrum:FREQuency:SCALE`..... 310

`SPECTrum:WAVEform:AVERAge[:ENABLE]`..... 310

`SPECTrum:WAVEform:MAXimum[:ENABLE]`.....311

`SPECTrum:WAVEform:MINimum[:ENABLE]`.....311

`SPECTrum:WAVEform:SPECTrum[:ENABLE]`..... 311

`SPECTrum:FREQuency:RESet`..... 311

SPECTrum:MODE?

Queries the most recently activated spectrum analysis mode.

Return values:

<Mode> FFT | SPECTrum
 *RST: FFT

Usage: Query only

SPECTrum:FREQuency:AVERAge:COUNT <NoOfAvs>

Defines the number of measurements to average for the average trace (see [SPECTrum:WAVEform:AVERAge\[:ENABLE\]](#) on page 310).

Parameters:

<NoOfAvs> Range: 2 to 1024
 Increment: 2
 *RST: 64

SPECTrum:FREQuency:BANDwidth[:RESolution]:AUTO <State>

If enabled, the optimal resolution bandwidth is determined automatically by the spectrum application according to the frequency span and selected window type.

If disabled, the RBW is set according to the ratio defined by `SPECTrum:FREQuency:BANDwidth[:RESolution]:RATio` on page 309.

Parameters:

<State> ON | OFF
 *RST: ON

SPECTrum:FREQuency:BANDwidth[:RESolution]:RATio <RBWRatio>

Determines the resolution of the spectrum, that is: the minimum distance between two distinguishable frequencies.

If you change the span, the RBW is automatically adjusted to the minimum or maximum allowed value, if necessary.

In FFT mode, this command is read-only.

Parameters:

<RBWRatio> R10 | R20 | R50 | R100 | R200 | R500 | R1K
R10
 Corresponds to the "RBW:Span Ratio" setting "1:10" in manual operation.
R1K
 Corresponds to the "RBW:Span Ratio" setting "1:1000" in manual operation.
 *RST: R200

SPECTrum:FREQuency:FULLspan

This command is only available in Spectrum mode. It sets the displayed frequency range to the entire measured span.

Usage: Event

SPECTrum:FREQuency:MAGNitude:REFerence[:VALue] <RefLevel>

Defines the expected maximum input signal level. Signal levels above this value may not be measured correctly. The reference level is also used as the maximum on the y-axis.

This command is only available in Spectrum mode.

Parameters:

<RefLevel> Range: -160 to 160
 Increment: 1
 *RST: 0
 Default unit: dB

SPECTrum:FREQuency:POSition <Frequency>

Configures the position of the spectrum within the vertical diagram grid. Changing this value has the same effect as using the POS keys on the instrument.

Note that this command contains the keyword FREQuency for compatibility reasons. In effect, it changes the level position in the spectrum diagram.

Parameters:

<Frequency> Defines the number of divisions in the vertical grid that the spectrum is moved up (positive value) or down (negative value).
 Range: -4 to 4
 Increment: 0.5
 *RST: 2
 Default unit: none

SPECTrum:FREQuency:SCALe <VerticalScale>

Configures the scale of the **y**-axis of the spectrum, which is indicated in the channel settings beneath the spectrum diagram. Changing this value has the same effect as using the RANGE keys on the instrument.

Note that this command contains the keyword FREQuency for compatibility reasons. In effect, it changes the level scaling in the spectrum diagram.

Parameters:

<VerticalScale> Defines the level range displayed in one division of the vertical grid.
 Range: 0.5 to 40
 Increment: 0.1
 *RST: 10
 Default unit: dB

Usage: Asynchronous command

SPECTrum:WAVeform:AVERage[:ENABLE] <State>

Displays the averaged spectrum trace. The number of traces to average is defined using [SPECTrum:FREQuency:AVERage:COUNT](#) on page 308.

Parameters:

<State> ON | OFF
 *RST: OFF

SPECTrum:WAVeform:MAXimum[:ENABLE] <State>

Displays the "Max Hold" spectrum trace.

Parameters:

<State> ON | OFF
 *RST: OFF

SPECTrum:WAVeform:MINimum[:ENABLE] <State>

Displays the "Min Hold" spectrum trace.

Parameters:

<State> ON | OFF
 *RST: OFF

SPECTrum:WAVeform:SPECTrum[:ENABLE] <State>

Displays the clear/write spectrum trace.

Parameters:

<State> ON | OFF
 *RST: ON

SPECTrum:FREQuency:RESet

Clears the results for previous measurements used in statistical evaluation (see [SPECTrum:WAVeform:AVERage\[:ENABLE\]](#), [SPECTrum:WAVeform:MAXimum\[:ENABLE\]](#), [SPECTrum:WAVeform:MINimum\[:ENABLE\]](#) and [SPECTrum:FREQuency:AVERage:COUNT](#) on page 308).

Usage: Event

14.6.2.2 Cursor Measurements in Spectrum Mode

Special cursor commands are available for the Spectrum mode.

SPECTrum:CURSor<m>:STATe	311
SPECTrum:CURSor<m>:SOURce	312
SPECTrum:CURSor<m>:COUPLing	312
SPECTrum:CURSor<m>:SCPLing	312
SPECTrum:CURSor<m>:FREQuency[:VALue]	313
SPECTrum:CURSor<m>:FREQuency:DELTA?	313
SPECTrum:CURSor<m>:LEVel[:VALue]?	313
SPECTrum:CURSor<m>:LEVel:DELTA?	313
SPECTrum:CURSor<m>:SCReen	314

SPECTrum:CURSor<m>:STATe <State>

Enables or disables the spectrum cursor measurement.

Suffix:

<m> 1..2

Parameters:<State> ON | OFF
*RST: OFF**SPECTrum:CURSor<m>:SOURce <TraceSource>**

Selects the trace on which the cursors are placed. Only active traces are available.

See:

- [SPECTrum:WAVEform:MAXimum\[:ENABLE\]](#) on page 311
- [SPECTrum:WAVEform:MINimum\[:ENABLE\]](#) on page 311
- [SPECTrum:WAVEform:SPECTrum\[:ENABLE\]](#) on page 311
- [SPECTrum:WAVEform:AVERage\[:ENABLE\]](#) on page 310

Suffix:

<m> 1..2

Parameters:<TraceSource> SPECTrum | MAXimum | MINimum | AVERage
*RST: SPECTrum**SPECTrum:CURSor<m>:COUPling <State>**

Couples the cursor lines so that the distance between the two lines remains the same if one cursor is moved.

Suffix:<m> 1..2
irrelevant**Parameters:**<State> ON | OFF
*RST: OFF**SPECTrum:CURSor<m>:SCPLing <State>**

If enabled, the position of the cursor lines is adjusted if the vertical or horizontal scales are changed. The cursor lines keep their relative position to the waveform.

If disabled, the cursor lines remain on their position on the display if the scaling is changed.

Suffix:

<m> 1..2

Parameters:<State> ON | OFF
*RST: ON

SPECTrum:CURSor<m>:FREQUency[:VALue] <Frequency>

Queries the frequency at the specified cursor.

Suffix:

<m> 1..2

Parameters:

<Frequency> Range: 0 to 500E+6
Increment: 10
*RST: 100E+6
Default unit: Hz

SPECTrum:CURSor<m>:FREQUency:DELTA?

Queries the difference between the measured frequencies at both cursors.

Suffix:

<m> 1..2
irrelevant

Return values:

<FrequencyDelta> Range: -500E+6 to 500E+6
Increment: 10
*RST: 300E+6
Default unit: Hz

Usage: Query only

SPECTrum:CURSor<m>:LEVel[:VALue]?

Queries the measured level at the specified cursor.

Suffix:

<m> 1..2

Return values:

<Level> Range: -260 to 260
Increment: 1
*RST: 0
Default unit: dB

Usage: Query only

SPECTrum:CURSor<m>:LEVel:DELTA?

Queries the difference in the measured levels for both cursors.

Suffix:

<m> 1..2
irrelevant

Return values:

<LevelDelta> Range: -520 to 520
 Increment: 1
 *RST: 0
 Default unit: dB

Usage: Query only

SPECTrum:CURSor<m>:SCReen

Sets the cursors to a default position on the screen.

Suffix:

<m> 1..2

Usage: Event

14.6.2.3 Markers in Spectrum Mode

Special marker commands are available for the Spectrum mode.

SPECTrum:MARKer[:STATe].....	314
SPECTrum:MARKer:COUNT.....	314
SPECTrum:MARKer:SOURce.....	315
SPECTrum:MARKer:SETup:DISTance.....	315
SPECTrum:MARKer:SETup:EXCURsion.....	315
SPECTrum:MARKer:SETup:MLeVel.....	315
SPECTrum:MARKer:RCOunt?.....	316
SPECTrum:MARKer:RESult<m>:FREQuency[:VALue]?.....	316
SPECTrum:MARKer:RESult<m>:FREQuency:DELTA?.....	316
SPECTrum:MARKer:RESult<m>:LEVel[:VALue]?.....	317
SPECTrum:MARKer:RESult<m>:LEVel:DELTA?.....	317
SPECTrum:MARKer:RMARker:FREQuency?.....	317
SPECTrum:MARKer:RMARker:VALue?.....	318

SPECTrum:MARKer[:STATe] <State>

If enabled, a peak search is performed on the current spectrum results.

Parameters:

<State> ON | OFF
 *RST: OFF

SPECTrum:MARKer:COUNT <NumberOfMarkers>

Defines the number of markers used to indicate peaks in the spectrum results. With 3 active markers, the 3 peak values in the spectrum are indicated.

Parameters:

<NumberOfMarkers> Range: 1 to 15
 Increment: 1
 *RST: 3

SPECTrum:MARKer:SOURce <TraceSource>

Determines the trace used for the peak search.

Parameters:

<TraceSource> SPECTrum | MAXimum | MINimum | AVERage
 *RST: SPECTrum

SPECTrum:MARKer:SETup:DISTance <Distance>

Defines a minimum distance between two frequencies that must be exceeded in order to detect individual peaks.

Parameters:

<Distance> Range: 0 to 500E+6
 Increment: 10
 *RST: 1E+6
 Default unit: Hz

SPECTrum:MARKer:SETup:EXCursion <Excursion>

Defines a relative threshold, the minimum level value by which the waveform must rise or fall to be considered a peak. To avoid identifying noise peaks, enter a peak excursion value that is higher than the noise levels.

See also "[Peak excursion](#)" on page 119.

Parameters:

<Excursion> Range: 0 to 260
 Increment: 1
 *RST: 10
 Default unit: dB

SPECTrum:MARKer:SETup:MLEVEL <Threshold>

Defines an absolute level threshold as an additional condition for the peak search. Only peaks that exceed the threshold are detected.

Parameters:

<Threshold> Range: -260 to 260
 Increment: 1
 *RST: -40
 Default unit: dB

SPECTrum:MARKer:RCOunt?

Queries the number of markers for which peaks were actually detected during the peak search. Note that the number of markers is restricted by the [SPECTrum:MARKer:COUnT](#) command.

Return values:

<NumberOfResults> Range: 0 to 15
 Increment: 1
 *RST: 0

Usage: Query only

SPECTrum:MARKer:RESult<m>:FREQUency[:VALue]?

Queries the frequency of the specified marker.

Suffix:

<m> 1 to 15
 Number of the marker. The maximum number depends on how many markers were selected and how many peaks were detected (see [SPECTrum:MARKer:RCOunt?](#) on page 316).

Return values:

<Frequency> Range: -10E+9 to 10E+9
 Increment: 10
 *RST: 10E+6
 Default unit: Hz

Usage: Query only

SPECTrum:MARKer:RESult<m>:FREQUency:DELTA?

Queries the frequency difference between the reference marker and the specified marker.

Suffix:

<m> 1 to 15
 Marker; maximum depends on active markers and detected peaks (see [SPECTrum:MARKer:COUnT](#) and [SPECTrum:MARKer:RCOunt?](#))

Return values:

<FrequencyDelta> Range: -10E+9 to 10E+9
 Increment: 10
 *RST: 10E+6
 Default unit: Hz

Usage: Query only

SPECTrum:MARKer:RESult<m>:LEVel[:VALue]?

Queries the power level of the specified marker in relation to the reference marker (see [SPECTrum:MARKer:RMARker:VALue?](#) on page 318).

Suffix:

<m> 1 to 15
Number of the marker. The maximum number depends on how many markers were selected and how many peaks were detected (see [SPECTrum:MARKer:RCOUNT?](#) on page 316).

Return values:

<Level> Range: -260 to 260
Increment: 1
*RST: 0
Default unit: dB

Usage: Query only

SPECTrum:MARKer:RESult<m>:LEVel:DELTA?

Queries the level difference between the reference marker and the specified marker.

Suffix:

<m> 1 to 15
Marker; maximum depends on active markers and detected peaks (see [SPECTrum:MARKer:COUNT](#) and [SPECTrum:MARKer:RCOUNT?](#))

Return values:

<LevelDelta> Range: -520 to 520
Increment: 1
*RST: 0
Default unit: dB

Usage: Query only

SPECTrum:MARKer:RMARker:FREQUency?

Queries the frequency of the reference marker. The reference marker is the one with the highest level.

Return values:

<Frequency> Range: -10E+9 to 10E+9
Increment: 10
*RST: 10E+6
Default unit: Hz

Usage: Query only

SPECTrum:MARKer:RMARker:VALue?

Queries the measured level at the reference marker.

Return values:

<Level> Range: -260 to 260
 Increment: 1
 *RST: 0
 Default unit: dB

Usage: Query only

14.6.2.4 Exporting Spectrum Analysis Results

You can export the spectrum results to a file, similar to waveforms (see [Chapter 14.13](#), "Documenting Results", on page 424).

SPECTrum:EXPort:NAME	318
SPECTrum:EXPort:SAVE	318
SPECTrum:EXPort:INCXvalues	318

SPECTrum:EXPort:NAME <Name>

Defines the file name, file format and path to save the spectrum measurement results.

Parameters:

<Name> String with path and file name with extension `.csv`.

SPECTrum:EXPort:SAVE

Saves the results of the spectrum measurement to the file specified using [SPECTrum:EXPort:NAME](#).

For a description of the file format see [Chapter 5.2.9](#), "Spectrum Results Export File Format", on page 124.

Example:

```
SPECTrum:EXPort:NAME 'SpectrumResults'
SPECTrum:EXPort:SAVE
SPECTrum:EXPort:NAME?
//Result: /media/SD/Rohde-Schwarz/RTH/Export/SpectrumResults.csv
```

Usage: Event

SPECTrum:EXPort:INCXvalues <State>

Includes the frequency values in the stored results.

Parameters:

<State> ON | OFF
 *RST: ON

14.6.3 Harmonic Mode (R&S RTH-B34)

To activate Harmonic mode, use `OP HARM` (see `OP [:MODE]` on page 251).

The following commands are only available if the Harmonic Analysis option R&S RTH-B34 is installed.

- [Configuring Harmonic Measurements](#).....319
- [Retrieving and Exporting Harmonic Results](#)..... 323

14.6.3.1 Configuring Harmonic Measurements

HARMonic:AVERage	319
HARMonic:CLEar	319
HARMonic:DISPlay:TYPE	319
HARMonic:DISPlay:USER	320
HARMonic:FUNDamental:CURRent?	320
HARMonic:FUNDamental:TYPE	320
HARMonic:FUNDamental:USER	321
HARMonic:LIMits:CURRent?	321
HARMonic:LIMits:LOAD	321
HARMonic:LIMits:NAME	322
HARMonic:LIMits:TYPE	322
HARMonic:SCALE	322
HARMonic:STATistic	322
HARMonic:THDType	323

HARMonic:AVERage <Average>

Determines the number of measurements for which the results are averaged. By default, no averaging is performed.

Parameters:

<Average> OFF | AV2 | AV4 | AV8 | AV16 | AV32
 *RST: OFF

HARMonic:CLEar

Clears the results for previous measurements used in statistical evaluation (see [HARMonic:AVERage](#) on page 319 and [HARMonic:STATistic](#) on page 322).

Usage: Event

HARMonic:DISPlay:TYPE <Selection>

Determines the number of harmonics to be displayed in the bargraph.

Note that this setting only affects the graphical result display; it has no effect on the selection of harmonics for which results are provided during a file export (manually or via remote command). For that purpose, use [HARMonic:LIMits:TYPE](#) on page 322.

Harmonics that were previously eliminated by the `HARMonic:LIMits:TYPE` command cannot be displayed.

Parameters:

<Selection> ALL | EVEN | ODD | ODD3 | ODN3 | USER

ODD3

All harmonics with an odd-numbered order that is a multiple of 3

ODN3

All harmonics with an odd-numbered order that cannot be divided by 3

USER

Selects a user-defined number of harmonics. Define the number of harmonics using the `HARMonic:DISPlay:USER` command.

*RST: ALL

HARMonic:DISPlay:USER <MaxHarmonics>

Determines the maximum number of harmonics to be displayed in the bargraph. This command requires a preceding `HARM:DISP:TYPE USER` command.

Note that this setting only affects the graphical result display; it has no effect on the selection of harmonics for which results are provided during a file export (manually or via remote command). For that purpose, use `HARMonic:LIMits:TYPE` on page 322.

Harmonics that are eliminated by the `HARMonic:LIMits:TYPE` command cannot be displayed.

Parameters:

<MaxHarmonics> Range: 1 to 64
Increment: 1
*RST: 10

Example:

```
HARM:DISP:TYPE USER
HARM:DISP:USER 25
Displays the first 25 harmonics.
```

HARMonic:FUNDamental:CURRENT?**Return values:**

<CurrFreq> Range: 10 to 1000
Increment: 0.01
*RST: 50
Default unit: Hz

Usage: Query only

HARMonic:FUNDamental:TYPE <Fundamental>

Defines the basis of the harmonics measurement. Harmonics are determined as multiples of this frequency.

Parameters:

<Fundamental> F50 | F60 | F400 | USER

F50
50 Hz

F60
60 Hz

F400
400 Hz

USER
User-defined frequency; define the frequency using [HARMonic:FUNDamental:USER](#)

*RST: F50

Example:

```
HARMonic:FUNDamental:TYPE USER
HARMonic:FUNDamental:USER 123
HARMonic:FUNDamental:CURRENT?
//Result: 123
```

HARMonic:FUNDamental:USER <UserFrequency>

Defines the user-defined fundamental frequency for [HARMonic:FUNDamental:TYPE USER](#):

Parameters:

<UserFrequency> Range: 10 to 1000
Increment: 0.1
*RST: 50
Default unit: Hz

Example:

```
HARMonic:FUNDamental:TYPE USER
HARMonic:FUNDamental:USER 123
HARMonic:FUNDamental:CURRENT?
//Result: 123
```

HARMonic:LIMits:CURRENT?**Return values:**

<Current>

Usage: Query only

HARMonic:LIMits:LOAD

Loads the file selected by [HARMonic:LIMits:NAME](#) on page 322.

Example:

```
HARM:LIM:NAME
'/media/SD/Rohde-Schwarz/RTH/Harmonic/LimitExample.csv'
HARM:LIM:LOAD
```

Usage: Event

HARMonic:LIMits:NAME <FileName>**Parameters:**

<FileName> String containing the path and name of the user-defined configuration file to be loaded.

Example:

```
HARM:LIM:NAME
'/media/SD/Rohde-Schwarz/RTH/Harmonic/LimitExample.csv'
HARM:LIM:LOAD
```

HARMonic:LIMits:TYPE <Type>

Defines the type of limit check to be performed.

Parameters:

<Type> NONE | EN50160 | USER

NONE

No limit check is performed.

EN50160

Limits are checked according to the predefined values in the EN50160 standard.

USER

Limits are checked according to the values in a user-defined file (see [HARMonic:LIMits:LOAD](#) on page 321). For details on the required file format see [Chapter 5.3.6.1, "Limit File Format"](#), on page 134.

*RST: NONE

HARMonic:SCALe <Unit>

Switches the scale for the measured harmonic levels between logarithmic (db) and linear (percent). The values are relative to the level measured for the fundamental frequency, or to the level measured for the entire signal, depending on the selected THD type (see [HARMonic:THDType](#) on page 323).

Parameters:

<Unit> PERCent | DB

*RST: DB

HARMonic:STATistic <Type>

By default, the numeric results indicate the currently measured values. Optionally, you can switch to the minimum or maximum values.

Parameters:

<Type> CURRent | MIN | MAX

*RST: CURRent

HARMonic:THDType <THDType>

Parameters:

<THDType> THDF | THDR

THDF

The RMS amplitude (voltage or current) of the harmonics relative to the RMS amplitude of the fundamental component

THDR

The RMS amplitude of the harmonics relative to the RMS amplitude of the input signal

*RST: THDF

14.6.3.2 Retrieving and Exporting Harmonic Results

You can export the harmonic results to a file, similar to waveforms (see [Chapter 14.13, "Documenting Results"](#), on page 424).

HARMonic:EXPort:NAME.....	323
HARMonic:EXPort:SAVE.....	324
HARMonic:RESult<m>:CLIPping?.....	324
HARMonic:RESult<m>:FRQMissing?.....	324
HARMonic:RESult<m>:FUNDamental?.....	325
HARMonic:RESult<m>:HARMonics<n>:ABSMagnitude:MAXimum?.....	325
HARMonic:RESult<m>:HARMonics<n>:ABSMagnitude:MINimum?.....	325
HARMonic:RESult<m>:HARMonics<n>:ABSMagnitude[:CURRent]?.....	325
HARMonic:RESult<m>:HARMonics<n>:LIMCheck?.....	325
HARMonic:RESult<m>:HARMonics<n>:LIMit?.....	326
HARMonic:RESult<m>:HARMonics<n>:LIMViolation?.....	326
HARMonic:RESult<m>:HARMonics<n>:PHASe?.....	327
HARMonic:RESult<m>:HARMonics<n>:RELMagnitude:MAXimum?.....	328
HARMonic:RESult<m>:HARMonics<n>:RELMagnitude:MINimum?.....	328
HARMonic:RESult<m>:HARMonics<n>:RELMagnitude[:CURRent]?.....	328
HARMonic:RESult<m>:HARMonics<n>[:FREQUency]?.....	328
HARMonic:RESult<m>:LIMViolation?.....	328
HARMonic:RESult<m>:NOHarmonics?.....	329
HARMonic:RESult<m>:NOResults?.....	329
HARMonic:RESult<m>:RMS:MAXimum?.....	329
HARMonic:RESult<m>:RMS:MINimum?.....	329
HARMonic:RESult<m>:RMS[:CURRent]?.....	329
HARMonic:RESult<m>:THD:MAXimum?.....	330
HARMonic:RESult<m>:THD:MINimum?.....	330
HARMonic:RESult<m>:THD[:CURRent]?.....	330

HARMonic:EXPort:NAME <Name>

Defines the file name, file format and path to save the harmonic measurement results.

Parameters:

<Name> String with path and file name with extension `.csv`.

HARMonic:EXPort:SAVE

Saves the results of the harmonic measurement to the file specified using [HARMonic:EXPort:NAME](#).

Example:

```
HARMonic:EXPort:NAME 'HarmonicResults'
HARMonic:EXPort:SAVE
HARMonic:EXPort:NAME?
//Result: /media/SD/Rohde-Schwarz/RTH/Export/HarmonicResults.csv
```

Usage: Event

HARMonic:RESult<m>:CLIPping?

Indicates whether clipping has occurred, that is: the amplitudes exceed the currently defined amplitude range.

Suffix:
<m> 1|2 (RTH1002) , 1..4 (RTH1004)
Input channel

Return values:
<State> ON | OFF

ON
Clipping has occurred, increase the amplitude range (see [CHANnel<m>:RANGe](#) on page 253).

OFF
No clipping has occurred, the current measurement settings are suitable.

*RST: OFF

Usage: Query only

HARMonic:RESult<m>:FRQMissing?

Queries whether the fundamental frequency was detected in the input signal or not. If the specified frequency $\pm 10\%$ is not detected in the signal, the measurement is invalid.

Suffix:
<m> 1|2 (RTH1002) , 1..4 (RTH1004)

Return values:
<State> ON | OFF

OFF
The fundamental frequency was not detected, the measurement is invalid. Define the correct frequency of the input signal.

ON
The fundamental frequency was detected, the measurement is valid.

*RST: OFF

Usage: Query only

HARMonic:RESult<m>:FUNDamental?

Suffix:

<m> 1|2 (RTH1002) , 1..4 (RTH1004)

Return values:

<Frequency> Range: 9 to 1005
 Increment: 10E-6
 *RST: 0
 Default unit: Hz

Usage: Query only

HARMonic:RESult<m>:HARMonics<n>:ABSMagnitude:MAXimum?

HARMonic:RESult<m>:HARMonics<n>:ABSMagnitude:MINimum?

HARMonic:RESult<m>:HARMonics<n>:ABSMagnitude[:CURRent]?

Returns the currently measured, minimum or maximum power level of the selected harmonic.

Suffix:

<m> 1|2 (RTH1002) , 1..4 (RTH1004)

<n> 1..64
 Order of harmonic (possibly restricted, see [HARMonic:RESult<m>:NOHarmonics?](#))

Return values:

<AbsMagnitude>

Usage: Query only

HARMonic:RESult<m>:HARMonics<n>:LIMCheck?

Queries whether a limit is defined for the specified harmonic (either by the EN50160 standard or by a user-defined configuration file). Only if a limit value is defined, a limit check is performed for the harmonic.

Suffix:

<m> 1|2 (RTH1002) , 1..4 (RTH1004)

<n> 1..64
 Order of harmonic (possibly restricted, see [HARMonic:RESult<m>:NOHarmonics?](#))

Return values:

<State> ON | OFF

ON

A limit is specified and a limit check will be performed.

OFF

No limit is specified, so no limit check will be performed for the harmonic.

Example:

```
HARM:LIM:TYPE EN50160
HARM:RES1:HARM2:LIMC?
//Result: 1
HARM:RES1:HARM2:LIM?
//Result: 2%
HARM:RES1:HARM2:LIMV?
//Result: 0
```

Usage:

Query only

HARMOinic:RESult<m>:HARMOinics<n>:LIMit?

Queries the limit defined for the specified harmonic.

Note: Only if a limit value is defined, a limit check is performed for the harmonic (see [HARMOinic:RESult<m>:HARMOinics<n>:LIMCheck?](#) on page 325).

Suffix:

<m> 1|2 (RTH1002) , 1..4 (RTH1004)

<n> 1..64

Order of harmonic (possibly restricted, see [HARMOinic:RESult<m>:NOHarmonics?](#))**Return values:**

<Limit> percentage

Example:

```
HARM:LIM:TYPE EN50160
HARM:RES1:HARM2:LIMC?
//Result: 1
HARM:RES1:HARM2:LIM?
//Result: 2%
HARM:RES1:HARM2:LIMV?
//Result: 0
```

Usage:

Query only

HARMOinic:RESult<m>:HARMOinics<n>:LIMViolation?

Queries whether the calculated level for the specified harmonic exceeds the defined.

Note: Only if a limit value is defined, a limit check is performed for the harmonic (see [HARMOinic:RESult<m>:HARMOinics<n>:LIMCheck?](#) on page 325).

Tip: To query the result of the limit check for the entire signal, use [HARMonic:RESult<m>:LIMViolation?](#) on page 328.

Suffix:

<m> 1|2 (RTH1002) , 1..4 (RTH1004)

<n> 1..64
Order of harmonic (possibly restricted, see [HARMonic:RESult<m>:NOHarmonics?](#))

Return values:

<State> ON | OFF

ON

A limit violation occurred - the limit was exceeded.

OFF

No limit violation occurred.

Example:

```
HARM:LIM:TYPE EN50160
HARM:RES1:HARM2:LIMC?
//Result: 1
//The EN50160 defines a limit of 2% for the
//second order harmonic.
HARM:RES1:HARM2:LIM?
//Result: 2
HARM:RES1:HARM2:LIMV?
//Result: 1
//The calculated value exceeds the defined
// limit for the second harmonic.
HARM:RES1:LIMV?
//Result: 1
//Since the limit check for the second harmonic
// failed, the limit check for the entire
// signal failed.
```

Usage: Query only

HARMonic:RESult<m>:HARMonics<n>:PHASe?

Queries the calculated phase value for the specified harmonic.

Suffix:

<m> 1|2 (RTH1002) , 1..4 (RTH1004)

<n> 1..64
Order of harmonic (possibly restricted, see [HARMonic:RESult<m>:NOHarmonics?](#))

Return values:

<Phase> Default unit: degrees

Usage: Query only

HARMonic:RESult<m>:HARMonics<n>:RELMagnitude:MAXimum?**HARMonic:RESult<m>:HARMonics<n>:RELMagnitude:MINimum?****HARMonic:RESult<m>:HARMonics<n>:RELMagnitude[:CURRent]?**

Returns the currently measured, minimum or maximum power level of the selected harmonic, relative to the power level of the fundamental frequency.

Suffix:

<m> 1|2 (RTH1002) , 1..4 (RTH1004)

<n> 1..64
Order of harmonic (possibly restricted, see [HARMonic:RESult<m>:NOHarmonics?](#))

Return values:

<RelMagnitude> Default unit: %

Usage: Query only

HARMonic:RESult<m>:HARMonics<n>[:FREQUENCY]?

Queries the determined frequency value for the specified harmonic.

Suffix:

<m> 1|2 (RTH1002) , 1..4 (RTH1004)

<n> 1..64
Order of harmonic (possibly restricted, see [HARMonic:RESult<m>:NOHarmonics?](#))

Return values:

<Frequency> Default unit: Hz

Usage: Query only

HARMonic:RESult<m>:LIMViolation?

Queries the result of the limit check for all harmonics. If a single harmonic violates its defined limit, the limit check for the entire signal fails.

Note: Only if a limit value is defined, a limit check is performed for the harmonic (see [HARMonic:RESult<m>:HARMonics<n>:LIMCheck?](#) on page 325).

Tip: To query the result of the limit check for an individual harmonic, use [HARMonic:RESult<m>:HARMonics<n>:LIMViolation?](#) on page 326.

Suffix:

<m> 1|2 (RTH1002) , 1..4 (RTH1004)

Return values:

<State> ON | OFF

ON
A limit violation occurred for at least one harmonic - the limit check for the signal failed.

OFF
No limit violations occurred. The limit check was passed.

*RST: OFF

Usage: Query only

HARMonic:RESult<m>:NOHarmonics?

Returns the number of harmonics for which results are displayed. The maximum number of 64 harmonics may be restricted due to the [HARMonic:LIMits:TYPE](#) command.

Suffix:

<m> 1|2 (RTH1002) , 1..4 (RTH1004)

Return values:

<NoSelection> Range: 1 to 64
Increment: 1
*RST: 64

Usage: Query only

HARMonic:RESult<m>:NOResults?

Returns the number of results included in averaging or statistics calculations. Invalid measurements are not included.

Suffix:

<m> 1|2 (RTH1002) , 1..4 (RTH1004)

Return values:

<NoResults> Range: 0 to 4000000000
Increment: 1
*RST: 0

Usage: Query only

HARMonic:RESult<m>:RMS:MAXimum?**HARMonic:RESult<m>:RMS:MINimum?****HARMonic:RESult<m>:RMS[:CURRent]?**

Returns the currently calculated, minimum, or maximum root mean square of the power in the entire signal, that is: for all harmonics and the fundamental frequency.

Suffix:

<m> 1|2 (RTH1002) , 1..4 (RTH1004)

Return values:

<RMS> Range: 0 to 100E+3
 Increment: 1E-12
 *RST: 0

Usage: Query only

HARMonic:RESult<m>:THD:MAXimum?

HARMonic:RESult<m>:THD:MINimum?

HARMonic:RESult<m>:THD[:CURRent]?

Returns the currently calculated, minimum, or maximum THD (total harmonic distortion), that is: the RMS of the amplitude of the harmonics. Which value the THD is set in relation to depends on the [HARMonic:THDType](#) command.

Suffix:

<m> 1|2 (RTH1002) , 1..4 (RTH1004)

Return values:

<THD> Range: 0 to 1000
 Increment: 0.1
 *RST: 0
 Default unit: %

Example:

HARM:THDT THDF

HARM:RES1:THD?

Returns the RMS amplitude (voltage or current) of the harmonics relative to the RMS amplitude of the fundamental component.

Usage: Query only

14.7 Digital Multimeter (R&S RTH1002)

- [Activating the Multimeter mode](#).....330
- [Measurement Configuration](#).....331
- [Relative Measurements](#)..... 338
- [Measurement Control](#).....340
- [Results](#)..... 342

14.7.1 Activating the Multimeter mode

To activate the DMM, use `OP METer`.

OP[:MODE] <OperationMode>

Sets the operating mode of the instrument.

Parameters:

<OperationMode> YT | XY | MASK | ROLL | METer | FFT | LOGGer | COUNter |
 PROTOcol | HARMonic | SPECtrum
 *RST: YT (scope mode)

14.7.2 Measurement Configuration

The instrument sets most configuration settings automatically. For most measurement types, the measurement range is the only parameter that can be set. For temperature measurements, specific settings are required.

The instrument can adjust the measurement range if autoranging is configured for a measurement. Otherwise, you can set a fixed measurement range.

To set a fixed measurement range, you can use several commands:

- `METer:CONFigure:<function>`
 Configures the specified measurement including the measurement range.
 See [Chapter 14.7.2.1, "METer:CONFigure Commands"](#), on page 331.
- `METer:SENSe:<function>:RANGe:UPPer`
 Sets the measurement range and turns off autoranging.
 See [Chapter 14.7.2.2, "METer:SENSe:<function>:RANGe:UPPER Commands"](#), on page 334.
- `METer:MEASure:<function>`
 Configures the specified measurement including the measurement range, starts the measurement, and returns the result.

To enable autoranging, you can use the following commands:

- `METer:SENSe:<function>:RANGe:AUTO`
 Enables or disables the autoranging. See [Chapter 14.7.2.3, "METer:SENSe:<function>:RANGe:AUTO Commands"](#), on page 336.
- `METer:CONFigure:<function> 'AUTO'`
 See [Chapter 14.7.2.1, "METer:CONFigure Commands"](#), on page 331.

The configuration commands are described in the following chapters:

- [METer:CONFigure Commands](#).....331
- [METer:SENSe:<function>:RANGe:UPPER Commands](#).....334
- [METer:SENSe:<function>:RANGe:AUTO Commands](#).....336
- [AC+DC Current and Voltage Measurements](#).....337
- [Temperature Measurements](#).....337

14.7.2.1 METer:CONFigure Commands

`METer:CONFigure:<function>` commands set all internal measurement parameters for the specified measurement. For most measurements, it also sets the measurement range.

To set the range to minimum, maximum, or default value, use the following parameters:

- `METer:CONFigure:<function> MIN`

- METer:CONFigure:<function> MAX
- METer:CONFigure:<function> DEF

For some measurements, you can also set the auto range:

METer:CONFigure:<function> 'AUTO'. Note that 'AUTO' is a string parameter. Alternatively, you can use the METer:SENSe:<function>:RANGE:AUTO commands.

The METer:CONFigure:<function> commands are only for configuration. To activate a measurement, use METer:SENSe:FUNCTion.

METer:CONFigure:VALue? returns the active measurement and range.

To read the result, use METer<m>:READ? or METer<m>:FETCh?.

METer:CONFigure:CONTInuity.....	332
METer:CONFigure:DIODE.....	332
METer:CONFigure:TEMPerature.....	332
METer:CONFigure:CAPacitance.....	332
METer:CONFigure:CURRent:AC.....	333
METer:CONFigure:CURRent:DC.....	333
METer:CONFigure:FREQuency.....	333
METer:CONFigure:RESistance.....	333
METer:CONFigure:VOLTagE:AC.....	333
METer:CONFigure:VOLTagE:DC.....	333

METer:CONFigure:CONTInuity
METer:CONFigure:DIODE
METer:CONFigure:TEMPerature

Configures the specified measurement. The instrument sets a fixed range.

Usage: Event

METer:CONFigure:CAPacitance

Sets the internal parameters and configures the range for capacitance measurements.

Parameters:

<Range> <numeric value> | 'AUTO' | MIN | MAX | DEF

<numeric value>

The instrument has fixed measurement ranges: 10 nF|100 nF| 1 µF|10 µF|100 µF|1 mF|10 mF.

You can enter any value between the minimum and maximum value. The instrument uses the next suitable range.

Range: 10 nF to 10 mF

*RST: 10 nF

Usage: Setting only

METer:CONFigure:CURRent:AC**METer:CONFigure:CURRent:DC**

Sets the internal parameters and configures the range for current measurements.

You need an external shunt resistor or I/U converter for current measurement.

Parameters:

<Range> <numeric value> | 'AUTO' | MIN | MAX | DEF

<numeric value>

The instrument has fixed measurement ranges: 1 A|10 A|100 A|1 kA.

You can enter any value between the minimum and maximum value. The instrument uses the next suitable range.

Range: 1 to 1000

*RST: 1

Default unit: A

Usage: Setting only

METer:CONFigure:FREQuency

Configures the frequency measurement and sets voltage autoranging.

To set a fixed voltage range, use `METer:SENSe:FREQuency:VOLTage:RANGe:UPPer`.

Usage: Event

METer:CONFigure:RESistance

Sets the internal parameters and configures the range for resistance measurements.

Parameters:

<Range> <numeric value> | 'AUTO' | MIN | MAX | DEF

<numeric value>

The instrument has fixed measurement ranges: 1 k Ω |10 k Ω |100 k Ω |1 M Ω |10 M Ω |100 M Ω .

You can enter any value between the minimum and maximum value. The instrument sets the next suitable range.

Range: 1 kOhm to 100 MOhm

*RST: AUTO

Usage: Setting only

METer:CONFigure:VOLTage:AC**METer:CONFigure:VOLTage:DC**

Sets the internal parameters and configures the range for voltage measurements.

Parameters:

<Range> <numeric value> | 'AUTO' | MIN | MAX | DEF
<numeric value>
 The instrument has fixed measurement ranges: 1 V|10 V|100 V| 1 kV.
 You can enter any value between the minimum and maximum value. The instrument uses the next suitable range.
 Range: 1 to 1000
 *RST: 1
 Default unit: V

Usage: Setting only

14.7.2.2 METer:SENSe:<function>:RANGe:UPPER Commands

METer:SENSe:<function>:RANGe:UPPER commands set the measurement range and turn off autoranging. You can use these commands in addition to METer:CONFigure commands if you want to change only the range.

METer:SENSe:CAPacitance:RANGe:UPPer.....	334
METer:SENSe:CURRent:AC:RANGe:UPPer.....	334
METer:SENSe:CURRent:DC:RANGe:UPPer.....	334
METer:SENSe:FREQuency:VOLTagE:RANGe:UPPer.....	335
METer:SENSe:RESistance:RANGe:UPPer.....	335
METer:SENSe:VOLTagE:AC:RANGe:UPPer.....	335
METer:SENSe:VOLTagE:DC:RANGe:UPPer.....	335

METer:SENSe:CAPacitance:RANGe:UPPer <Range>

Sets a fixed range for capacitance measurements and turns off auto ranging.

Parameters:

<Range> <numeric value> | MIN | MAX | DEF
<numeric value>
 The instrument has fixed measurement ranges: 10 nF|100 nF| 1 µF|10 µF|100 µF|1 mF|10 mF.
 You can enter any value between the minimum and maximum value. The instrument uses the next suitable range.
 Range: 10 nF to 10 mF
 *RST: 10 nF

METer:SENSe:CURRent:AC:RANGe:UPPer <Range>

METer:SENSe:CURRent:DC:RANGe:UPPer <Range>

Sets a fixed current range and turns off auto ranging.

Parameters:

<Range> <numeric value> | MIN | MAX | DEF

<numeric value>

The instrument has fixed measurement ranges: 1 A|10 A|100 A|1 kA.

You can enter any value between the minimum and maximum value. The instrument uses the next suitable range.

Range: 1 to 1000

*RST: 1

Default unit: A

METer:SENSe:FREQuency:VOLTage:RANGe:UPPer <Range>

Sets a fixed voltage range for frequency measurements and turns off auto ranging.

Parameters:

<Range> <numeric value> | MIN | MAX | DEF

<numeric value>

The instrument has fixed measurement ranges: 1 V|10 V|100 V|1 kV.

You can enter any value between the minimum and maximum value. The instrument uses the next suitable range.

Range: 1 to 1000

*RST: 1

Default unit: V

METer:SENSe:RESistance:RANGe:UPPer <Range>

Sets a fixed range for resistance measurements and turns off auto ranging.

Parameters:

<Range> <numeric value> | MIN | MAX | DEF

<numeric value>

The instrument has fixed measurement ranges: 1 k Ω |10 k Ω |100 k Ω |1 M Ω |10 M Ω |100 M Ω .

You can enter any value between the minimum and maximum value. The instrument sets the next suitable range.

Range: 1 kOhm to 100 MOhm

*RST: 1 kOhm

METer:SENSe:VOLTage:AC:RANGe:UPPer <Range>

METer:SENSe:VOLTage:DC:RANGe:UPPer <Range>

Sets a fixed voltage range and turns off auto ranging.

Parameters:

<Range> <numeric value> | MIN | MAX | DEF

<numeric value>
 The instrument has fixed measurement ranges: 1 V|10 V|100 V| 1 kV.
 You can enter any value between the minimum and maximum value. The instrument uses the next suitable range.

Range: 1 to 1000
 *RST: 1
 Default unit: V

14.7.2.3 METer:SENSe:<function>:RANGe:AUTO Commands

METer:SENSe:<function>:RANGe:AUTO commands turn autoranging on or off. For some measurements, you can also use the METer:CONFigure:<function> command, see Chapter 14.7.2.1, "METer:CONFigure Commands", on page 331.

METer:SENSe:CAPacitance:RANGe:AUTO.....	336
METer:SENSe:CURRent:AC:RANGe:AUTO.....	336
METer:SENSe:CURRent:DC:RANGe:AUTO.....	336
METer:SENSe:FREQuency:VOLTag:e:RANGe:AUTO.....	336
METer:SENSe:RESistance:RANGe:AUTO.....	336
METer:SENSe:VOLTag:e:AC:RANGe:AUTO.....	336
METer:SENSe:VOLTag:e:DC:RANGe:AUTO.....	336

- METer:SENSe:CAPacitance:RANGe:AUTO <State>**
- METer:SENSe:CURRent:AC:RANGe:AUTO <State>**
- METer:SENSe:CURRent:DC:RANGe:AUTO <State>**
- METer:SENSe:FREQuency:VOLTag:e:RANGe:AUTO <State>**
- METer:SENSe:RESistance:RANGe:AUTO <State>**
- METer:SENSe:VOLTag:e:AC:RANGe:AUTO <State>**
- METer:SENSe:VOLTag:e:DC:RANGe:AUTO <State>**

Disables or enables the autoranging for the specified measurement.

The query always returns OFF or ON.

Parameters:

<State> OFF | ON | ONCE

OFF | ON
 0 | 1 are not supported.

ONCE
 Performs an immediate autorange and then turns off the autoranging.

Example:

```
METer:SENSe:VOLTag:e:DC:RANGe:AUTO ONCE
METer:SENSe:VOLTag:e:DC:RANGe:AUTO?
<-- OFF
```

14.7.2.4 AC+DC Current and Voltage Measurements

METer<m>:SENSe:CURRent:AC:COUPling..... 337
 METer<m>:SENSe:VOLTagE:AC:COUPling..... 337

METer<m>:SENSe:CURRent:AC:COUPling <Coupling>
METer<m>:SENSe:VOLTagE:AC:COUPling <Coupling>

Enables AC+DC measurements.

Suffix:

<m> 1..4
 R&S RTH1002: always 1, omit the suffix
 R&S RTH1004: Selects the voltmeter.

Parameters:

<CoupVoltageMeas> DCLimit | ACLimit

DCLimit
 Enables AC+DC measurement.

ACLimit
 Enables AC measurement.

*RST: DCLimit

Example:

Configure and perform AC+DC current measurement with range 100 A:

```
:METer:CONFigure:CURRent:AC 100
:METer:SENSe:FUNcTion 'CURR:AC'
:METer:CONFigure:VALue?
<-- "CURR:AC 100"
:METer:SENSe:CURRent:AC:COUPling DCL
:METer:READ?
<-- 0.035906488794
```

Configure and perform AC voltage measurement with range 10 V:

```
:METer:CONFigure:VAOLTagE:AC 10
:METer:SENSe:FUNcTion 'VOLT:AC'
:METer:CONFigure:VALue?
<-- "VOLT:AC 10"
:METer:SENSe:CURRent:AC:COUPling ACL
:METer:READ?
<-- 0.030006488794
```

14.7.2.5 Temperature Measurements

METer:UNIT:TEMPerature..... 337
 METer:SENSe:TEMPerature:TRANsductor:RTD:TYPE..... 338

METer:UNIT:TEMPerature <Unit>

Sets the unit for temperature measurements.

Parameters:

<Unit> C | F | K

METer:SENSe:TEMPerature:TRANsductor:RTD:TYPE <Unit>

Sets the adapter type for temperature measurements.

Parameters:

<Unit> PT100 | PT500

14.7.3 Relative Measurements

To perform relative measurements, set the relevant

`METer:SENSe:<function>:NULL:STATe` command to ON. By default, the reference value is 0. Alternatively, you can use `METer<m>:SENSe:RELative:STATe`.To change the reference value, use the `METer:SENSe:<function>:NULL:VALue` command.

<code>METer:SENSe:CAPacitance:NULL:STATe</code>	338
<code>METer:SENSe:CURRent:AC:NULL:STATe</code>	338
<code>METer:SENSe:CURRent:DC:NULL:STATe</code>	338
<code>METer:SENSe:RESistance:NULL:STATe</code>	338
<code>METer:SENSe:TEMPerature:NULL:STATe</code>	338
<code>METer:SENSe:VOLTage:AC:NULL:STATe</code>	338
<code>METer:SENSe:VOLTage:DC:NULL:STATe</code>	338
<code>METer<m>:SENSe:NULL:STATe</code>	339
<code>METer<m>:SENSe:RELative:STATe</code>	339
<code>METer:SENSe:CAPacitance:NULL:VALue</code>	339
<code>METer:SENSe:CURRent:AC:NULL:VALue</code>	339
<code>METer:SENSe:CURRent:DC:NULL:VALue</code>	339
<code>METer:SENSe:VOLTage:AC:NULL:VALue</code>	339
<code>METer:SENSe:VOLTage:DC:NULL:VALue</code>	339
<code>METer:SENSe:RESistance:NULL:VALue</code>	340
<code>METer:SENSe:TEMPerature:NULL:VALue</code>	340
<code>METer<m>:SENSe:NULL:VALU</code>	340

METer:SENSe:CAPacitance:NULL:STATe <State>**METer:SENSe:CURRent:AC:NULL:STATe <State>****METer:SENSe:CURRent:DC:NULL:STATe <State>****METer:SENSe:RESistance:NULL:STATe <State>****METer:SENSe:TEMPerature:NULL:STATe <State>****METer:SENSe:VOLTage:AC:NULL:STATe <State>****METer:SENSe:VOLTage:DC:NULL:STATe <State>**Enables or disables the relative measurement. The reference value is defined using the appropriate `METer:SENSe:<function>:NULL:VALue` command.

Parameters:

<State> OFF | ON
 *RST: OFF

METer<m>:SENSe:NULL:STATe <SetRelative>

METer<m>:SENSe:RELative:STATe <SetRelative>

Enables or disables the relative measurement for the currently active measurement type.

Relative measurements are not available for diode, continuity, and frequency measurements.

Suffix:

<m> 1..4
 R&S RTH1002: always 1, omit the suffix
 R&S RTH1004: Selects the voltmeter.

Parameters:

<SetRelative> ON | OFF
 ON = 1, OFF = 0
 *RST: OFF

METer:SENSe:CAPacitance:NULL:VALue <ReferenceValue>

Sets the reference value for capacitance measurements. The measurement result is the difference of the measured sample and the reference value.

The value takes effect if relative measurement is on, see [METer:SENSe:CAPacitance:NULL:STATe](#).

Parameters:

<ReferenceValue> Range: +/- (1.1 * measurement range)
 *RST: 0
 Default unit: F

METer:SENSe:CURRent:AC:NULL:VALue <ReferenceValue>

METer:SENSe:CURRent:DC:NULL:VALue <ReferenceValue>

METer:SENSe:VOLTage:AC:NULL:VALue <ReferenceValue>

METer:SENSe:VOLTage:DC:NULL:VALue <ReferenceValue>

Sets the reference value for relative measurements. The measurement result is the difference of the measured sample and the reference value.

The value takes effect if relative measurement is on, see [METer:SENSe:<function>:NULL:STATe](#).

Parameters:

<ReferenceValue> Range: +/- (1.1 * measurement range)
 *RST: 0
 Default unit: V (VOLTage) | A (CURRent)

METer:SENSe:RESistance:NULL:VALue <ReferenceValue>

Sets the reference value for resistance measurements. The measurement result is the difference of the measured sample and the reference value.

The value takes effect if relative measurement is on, see [METer:SENSe:RESistance:NULL:STATe](#).

Parameters:

<ReferenceValue> Range: +/- (1.1 * measurement range)
 *RST: 0
 Default unit: Ohm

METer:SENSe:TEMPerature:NULL:VALue <ReferenceValue>

Sets the reference value for temperature measurements. The measurement result is the difference of the measured sample and the reference value.

The value takes effect if relative measurement is on, see [METer:SENSe:TEMPerature:NULL:STATe](#).

Parameters:

<ReferenceValue> Range: -200 to 850
 *RST: 0
 Default unit: To define the unit, use METer:UNIT:TEMPerature.

METer<m>:SENSe:NULL:VALU <ReferenceValue>

Sets the reference value for the currently active measurement type.

Relative measurements are not available for diode, continuity, and frequency measurements.

Suffix:

<m> 1..4
 R&S RTH1002: always 1, omit the suffix
 R&S RTH1004: Selects the voltmeter.

Parameters:

<ReferenceValue> Range: +/- (1.1 * measurement range)
 Default unit: Depends on the measurement type

14.7.4 Measurement Control

METer:SENSe:FUNcTION	341
METer:CONFIgure:VALue?	341
METer<m>:TRIGger:MODE	341
METer<m>:ABORT	342

METer:SENSe:FUNction <MeasType>

Sets the measurement type and activates it. All measurement attributes of the previous function (range, resolution, etc.) are remembered. If you return to the previous function, the measurement attributes are restored.

Changing the measurement type disables scaling, limit testing, histogram, statistics, and trend chart data collection: `CALC:<function>:STAT` is set OFF.

Setting parameters:

<MeasType> 'CAPacitance | CONTinuity | CURRent:AC | CURRent[:DC] |
CURRent:AD | DIODE | FREQuency | RESistance |
TEMPerature | VOLTage:AC | VOLTage[:DC] | VOLTage:AD'
String parameter
*RST: VOLTage [:DC]

Example: MET:SENS:FUNC "VOLT:AC"
MET:CONF:VAL?
<--"VOLT:AC 1"

Usage: Setting only

METer:CONFigure:VALue?

Returns the actual measurement type (short form) and the range.

Return values:

<Configuration> String parameter

Example: MET:CONF:VAL?
<--"VOLT:DC 100"
The DMM is set to DC voltage measurement and range 100 V.

Usage: Query only

METer<m>:TRIGger:MODE <TriggerMode>

Defines how long the instrument measures. To start the measurement again, use RUN or the appropriate `METer<m>:MEASure:<function>` command.

Suffix:

<m> 1..4
R&S RTH1002: always 1, omit the suffix
R&S RTH1004: Selects the voltmeter.

Parameters:

<TriggerMode> AUTO | SINGle
AUTO
The instrument performs continuous measurements.
SINGle
The instrument performs a single measurement.
*RST: AUTO

METer<m>:ABORt

Stops the running measurement.

Suffix:

<m> 1..4
 R&S RTH1002: always 1, omit the suffix
 R&S RTH1004: Selects the voltmeter.

Usage: Event

14.7.5 Results

- [Reading Values](#).....342
- [METer:MEASure Commands](#).....343
- [Statistics](#).....345

14.7.5.1 Reading Values

After configuration and selection of the active measurement, you can read the result values.

[METer<m>:INITiate](#).....342
[METer<m>:READ?](#)..... 342
[METer<m>:FETCh?](#)..... 343

METer<m>:INITiate

Resets the hardware and all statistical values, performs a single measurement and ends in hold mode.

Suffix:

<m> 1..4

Usage: Event

METer<m>:READ?

Starts a new measurement, returns the current measurement result and stays in run mode.

Suffix:

<m> 1..4
 R&S RTH1002: always 1, omit the suffix
 R&S RTH1004: Selects the voltmeter.

Return values:

<Meter result>

Usage: Query only

METer<m>:FETCh?

Returns the currently measured value.

Use this command after `METer<m>:INITiate`.

Suffix:

<m> 1..4
 R&S RTH1002: always 1, omit the suffix
 R&S RTH1004: Selects the voltmeter.

Return values:

<Result> Range: -100E+24 to 100E+24
 Increment: 0
 *RST: 0
 Default unit: V

Example:

```
METer:INITiate
METer:FETCh?
<-- 999.98564109
```

Usage: Query only

14.7.5.2 METer:MEASure Commands

Sending a `METer:MEASure:<function>?` command is the same as sending the `METer:CONFigure:<function>` command followed immediately by a `READ?` command.

<code>METer:MEASure:CONTinuity?</code>	343
<code>METer:MEASure:DIODE?</code>	343
<code>METer:MEASure:FREQuency?</code>	343
<code>METer:MEASure:TEMPerature?</code>	343
<code>METer:MEASure:CAPacitance?</code>	344
<code>METer:MEASure:CURREnt:AC?</code>	344
<code>METer:MEASure:CURREnt:DC?</code>	344
<code>METer:MEASure:RESistance?</code>	344
<code>METer:MEASure:VOLTage:AC?</code>	344
<code>METer:MEASure:VOLTage:DC?</code>	344

METer:MEASure:CONTinuity?**METer:MEASure:DIODE?****METer:MEASure:FREQuency?****METer:MEASure:TEMPerature?**

Configures the measurement and returns the result.

Return values:

<Range>

Usage: Query only

METer:MEASure:CAPacitance? [<ExpectedValue>]

Configures the capacitance measurement and returns the result.

Query parameters:

[<ExpectedValue>] <numeric value> | MIN | MAX | DEF | 'AUTO'

Optional parameter, expected measurement result or range. The instrument sets the appropriate measurement range.

See: [METer:CONFigure:CAPacitance](#).

Return values:

<Result> Numeric value

Usage: Query only

METer:MEASure:CURRent:AC? [<ExpectedValue>]**METer:MEASure:CURRent:DC?** [<ExpectedValue>]

Configures the current measurement and returns the result.

Query parameters:

[<ExpectedValue>] <numeric value> | MIN | MAX | DEF | 'AUTO'

Optional parameter, expected measurement result or range. The instrument sets the appropriate measurement range.

See: [METer:CONFigure:CURRent:DC](#).

Return values:

<Result> Numeric value

Example: :METer:MEASure:CURRent:DC? 15
<-- 13.4907681509

Usage: Query only

METer:MEASure:RESistance? [<ExpectedValue>]

Configures the resistance measurement and returns the result.

Query parameters:

[<ExpectedValue>] <numeric value> | MIN | MAX | DEF | 'AUTO'

Optional parameter, expected measurement result or range. The instrument sets the appropriate measurement range.

See: [METer:CONFigure:RESistance](#).

Return values:

<Result> Numeric value

Usage: Query only

METer:MEASure:VOLTage:AC? [<ExpectedValue>]**METer:MEASure:VOLTage:DC?** [<ExpectedValue>]

Configures the voltage measurement and returns the result.

Query parameters:

[<ExpectedValue>] <numeric value> | MIN | MAX | DEF | 'AUTO'

Optional parameter, expected measurement result or range. The instrument sets the appropriate measurement range.

See: [METer:CONFigure:VOLTagE:DC](#).

Return values:

<Result> Numeric value

Example:

```
:METer:MEASure:VOLTagE:DC? 5
```

```
<-- 3.4907681509
```

Usage:

Query only

14.7.5.3 Statistics

Before you can get statistical results, configure the measurement and select the measurement to be performed using [METer:SENSe:FUNction](#).

METer<m>:CALCulate:AVERage:AVERage?	345
METer<m>:CALCulate:AVERage:MINimum?	345
METer<m>:CALCulate:AVERage:MAXimum?	346
METer<m>:CALCulate:AVERage:CLEar	346

METer<m>:CALCulate:AVERage:AVERage?

Returns the mean value of the measurement series.

Suffix:

<m> 1..4
 R&S RTH1002: always 1, omit the suffix
 R&S RTH1004: Selects the voltmeter.

Return values:

<Average> Range: -100E+24 to 100E+24
 Increment: 1E-12
 *RST: 0
 Default unit: V

Usage:

Query only

METer<m>:CALCulate:AVERage:MINimum?

Returns the minimum value of the measurement series.

Suffix:

<m> 1..4
 R&S RTH1002: always 1, omit the suffix
 R&S RTH1004: Selects the voltmeter.

Return values:

<Minimum> Range: -100E+24 to 100E+24
 Increment: 1E-12
 *RST: 0
 Default unit: V

Usage: Query only

METer<m>:CALCulate:AVERage:MAXimum?

Returns the maximum value of the measurement series.

Suffix:

<m> 1..4
 R&S RTH1002: always 1, omit the suffix
 R&S RTH1004: Selects the voltmeter.

Return values:

<Maximum> Range: -100E+24 to 100E+24
 Increment: 1E-12
 *RST: 0
 Default unit: V

Usage: Query only

METer<m>:CALCulate:AVERage:CLEar

Deletes all statistical values.

Statistics are also deleted if:

- The measurement function changes (METer:SENSe:FUNction).
- *RST
- SYSTem:PRESet

Suffix:

<m> 1..4
 R&S RTH1002: always 1, omit the suffix
 R&S RTH1004: Selects the voltmeter.

Usage: Event

14.8 Voltmeter (R&S RTH1004)

- [Activating the Voltmeter](#)..... 347
- [Measurement Configuration](#)..... 347
- [Relative Measurements](#)..... 351
- [Measurement Control](#)..... 353
- [Results](#)..... 355

14.8.1 Activating the Voltmeter

METer<m>:SENSE:STATe <State>

Activates the voltmeter measurement.

Suffix:

<m> 1..4
Selects the voltmeter.

Parameters:

<State> ON | OFF
*RST: OFF

14.8.2 Measurement Configuration

The only parameter that can be set is the measurement range. All other settings are automatically adjusted by the instrument.

To set a fixed measurement range, you can use several commands:

- **METer<m>:CONFigure:<function>**
Configures the specified measurement including the measurement range.
See [Chapter 14.8.2.2, "METer<m>:CONFigure Commands"](#), on page 348.
- **METer<m>:SENSE:<function>:RANGE:UPPER**
Sets the measurement range.
See [Chapter 14.8.2.3, "METer<m>:SENSE:<function>:RANGE:UPPER Commands"](#), on page 349.
- **METer<m>:MEASure:<function>**
Configures the specified measurement including the measurement range, starts the measurement, and returns the result.

The configuration commands are described in the following chapters:

- [General Configuration](#)..... 347
- [METer<m>:CONFigure Commands](#)..... 348
- [METer<m>:SENSE:<function>:RANGE:UPPER Commands](#)..... 349
- [AC+DC Current and Voltage Measurements](#)..... 350

14.8.2.1 General Configuration

METer<m>:SENSE:SOURce <InputChannel>

Selects the input channel to be measured by the specified voltmeter.

Suffix:

<m> 1..4
Selects the voltmeter.

Parameters:

<InputChannel> C1 | C2 | C3 | C4
*RST: C1

METer<m>:SENSe:RANGe <MeterRangeUI>

Sets the measurement range of the input channel that is measured by the meter.

Suffix:

<m> 1..4
Selects the voltmeter.

Parameters:

<MeterRangeUI> Range: The range depends on the selected measurement type. For values, see the appropriate METer:CONFigure:<function> command.

14.8.2.2 METer<m>:CONFigure Commands

METer:CONFigure:<function> commands set all internal measurement parameters for the specified measurement, and also the measurement range.

To set the range to minimum, maximum, or default value, use the following parameters:

- METer<m>:CONFigure:<function> MIN
- METer<m>:CONFigure:<function> MAX
- METer<m>:CONFigure:<function> DEF

The METer<m>:CONFigure:<function> commands are only for configuration. To activate a measurement, use METer<m>:SENSe:FUNCTion on page 353.

METer<m>:CONFigure:VALue? returns the active measurement and range.

To read the result, use METer<m>:READ? or METer<m>:FETCh?.

METer<m>:CONFigure:CURRent:AC.....	348
METer<m>:CONFigure:CURRent:DC.....	348
METer<m>:CONFigure:VOLTag:AC.....	349
METer<m>:CONFigure:VOLTag:DC.....	349

METer<m>:CONFigure:CURRent:AC**METer<m>:CONFigure:CURRent:DC**

Sets the internal parameters and configures the range for current measurements.

You need an external shunt resistor or I/U converter for current measurement.

Suffix:

<m> 1..4
Selects the voltmeter.

Parameters:

<Range> <numeric value> | MIN | MAX | DEF

<numeric value>

The instrument has fixed measurement ranges: 1 A|10 A|100 A| 1 kA.

You can enter any value between the minimum and maximum value. The instrument uses the next suitable range.

Range: 1 to 1000

*RST: 1

Default unit: A

Usage: Setting only

METer<m>:CONFigure:VOLTage:AC

METer<m>:CONFigure:VOLTage:DC

Sets the internal parameters and configures the range for voltage measurements.

Suffix:

<m> 1..4
Selects the voltmeter.

Parameters:

<Range> <numeric value> | MIN | MAX | DEF

<numeric value>

The instrument has fixed measurement ranges: 1 V|10 V|100 V| 1 kV.

You can enter any value between the minimum and maximum value. The instrument uses the next suitable range.

Range: 1 to 1000

*RST: 1

Default unit: V

Usage: Setting only

14.8.2.3 METer<m>:SENSe:<function>:RANGe:UPPER Commands

METer<m>:SENSe:<function>:RANGe:UPPER commands set the measurement range. You can use these commands in addition to METer<m>:CONFigure commands if you want to change only the range.

METer<m>:SENSe:CURRent:AC:RANGe:UPPer.....	349
METer<m>:SENSe:CURRent:DC:RANGe:UPPer.....	349
METer<m>:SENSe:VOLTage:AC:RANGe:UPPer.....	350
METer<m>:SENSe:VOLTage:DC:RANGe:UPPer.....	350

METer<m>:SENSe:CURRent:AC:RANGe:UPPer <Range>

METer<m>:SENSe:CURRent:DC:RANGe:UPPer <Range>

Sets a fixed current range.

Suffix:

<m> 1..4
Selects the voltmeter.

Parameters:

<Range> <numeric value> | MIN | MAX | DEF
<numeric value>
 The instrument has fixed measurement ranges: 1 A|10 A|100 A| 1 kA.
 You can enter any value between the minimum and maximum value. The instrument uses the next suitable range.
 Range: 1 to 1000
 *RST: 1
 Default unit: A

METer<m>:SENSe:VOLTage:AC:RANGe:UPPer <Range>

METer<m>:SENSe:VOLTage:DC:RANGe:UPPer <Range>

Sets a fixed voltage range.

Suffix:

<m> 1..4
Selects the voltmeter.

Parameters:

<Range> <numeric value> | MIN | MAX | DEF
<numeric value>
 The instrument has fixed measurement ranges: 1 V|10 V|100 V| 1 kV.
 You can enter any value between the minimum and maximum value. The instrument uses the next suitable range.
 Range: 1 to 1000
 *RST: 1
 Default unit: V

14.8.2.4 AC+DC Current and Voltage Measurements

METer<m>:SENSe:CURRent:AC:COUPling..... 350
 METer<m>:SENSe:VOLTage:AC:COUPling..... 350

METer<m>:SENSe:CURRent:AC:COUPling <Coupling>

METer<m>:SENSe:VOLTage:AC:COUPling <Coupling>

Enables AC+DC measurements.

Suffix:

<m> 1..4
 R&S RTH1002: always 1, omit the suffix
 R&S RTH1004: Selects the voltmeter.

Parameters:

<CoupleVoltageMeas> DCLimit | ACLimit

DCLimit

Enables AC+DC measurement.

ACLimit

Enables AC measurement.

*RST: DCLimit

Example:

Configure and perform AC+DC current measurement with range 100 A:

```
:METer:CONFigure:CURRent:AC 100
:METer:SENSe:FUNCTion 'CURR:AC'
:METer:CONFigure:VALue?
<-- "CURR:AC 100"
:METer:SENSe:CURRent:AC:COUPling DCL
:METer:READ?
<-- 0.035906488794
```

Configure and perform AC voltage measurement with range 10 V:

```
:METer:CONFigure:VAOLTage:AC 10
:METer:SENSe:FUNCTion 'VOLT:AC'
:METer:CONFigure:VALue?
<-- "VOLT:AC 10"
:METer:SENSe:CURRent:AC:COUPling ACL
:METer:READ?
<-- 0.030006488794
```

14.8.3 Relative Measurements

To perform relative measurements, set the relevant

METer<m>:SENSe:<function>:NULL:STATe command to ON. By default, the reference value is 0. Alternatively, you can use METer<m>:SENSe:RELative:STATe.

To change the reference value, use the

METer<m>:SENSe:<function>:NULL:VALue command.

METer<m>:SENSe:CURRent:AC:NULL:STATe.....	352
METer<m>:SENSe:CURRent:DC:NULL:STATe.....	352
METer<m>:SENSe:VOLTage:AC:NULL:STATe.....	352
METer<m>:SENSe:VOLTage:DC:NULL:STATe.....	352
METer<m>:SENSe:NULL:STATe.....	352
METer<m>:SENSe:RELative:STATe.....	352
METer<m>:SENSe:CURRent:AC:NULL:VALue.....	352
METer<m>:SENSe:CURRent:DC:NULL:VALue.....	352
METer<m>:SENSe:VOLTage:AC:NULL:VALue.....	352
METer<m>:SENSe:VOLTage:DC:NULL:VALue.....	352
METer<m>:SENSe:NULL:VALU.....	353

METer<m>:SENSe:CURRent:AC:NULL:STATe <State>

METer<m>:SENSe:CURRent:DC:NULL:STATe <State>

METer<m>:SENSe:VOLTagE:AC:NULL:STATe <State>

METer<m>:SENSe:VOLTagE:DC:NULL:STATe <State>

Enables or disables the relative measurement. The reference value is defined using [METer:SENSe:<function>:NULL:VALue](#)

Suffix:

<m> 1..4
Selects the voltmeter.

Parameters:

<State> OFF | ON
*RST: OFF

METer<m>:SENSe:NULL:STATe <SetRelative>

METer<m>:SENSe:RELative:STATe <SetRelative>

Enables or disables the relative measurement for the currently active measurement type.

Relative measurements are not available for diode, continuity, and frequency measurements.

Suffix:

<m> 1..4
R&S RTH1002: always 1, omit the suffix
R&S RTH1004: Selects the voltmeter.

Parameters:

<SetRelative> ON | OFF
ON = 1, OFF = 0
*RST: OFF

METer<m>:SENSe:CURRent:AC:NULL:VALue <ReferenceValue>

METer<m>:SENSe:CURRent:DC:NULL:VALue <ReferenceValue>

METer<m>:SENSe:VOLTagE:AC:NULL:VALue <ReferenceValue>

METer<m>:SENSe:VOLTagE:DC:NULL:VALue <ReferenceValue>

Sets the reference value for relative measurements. The measurement result is the difference of the measured sample and the reference value.

The value takes effect if relative measurement is on, see [METer<m>:SENSe:VOLTagE:DC:NULL:STATe](#).

Suffix:

<m> 1..4
Selects the voltmeter.

Parameters:

<ReferenceValue> Range: +/- (1.1 * measurement range)
 *RST: 0
 Default unit: V (VOLTage) | A (CURRent)

METer<m>:SENSe:NULL:VALU <ReferenceValue>

Sets the reference value for the currently active measurement type.

Relative measurements are not available for diode, continuity, and frequency measurements.

Suffix:

<m> 1..4
 R&S RTH1002: always 1, omit the suffix
 R&S RTH1004: Selects the voltmeter.

Parameters:

<ReferenceValue> Range: +/- (1.1 * measurement range)
 Default unit: Depends on the measurement type

14.8.4 Measurement Control

METer<m>:SENSe:FUNctio.....	353
METer<m>:CONFigure:VALue?.....	354
METer<m>:TRIGger:MODE.....	354
METer<m>:ABORt.....	354

METer<m>:SENSe:FUNctio <MeasType>

Sets the measurement type for the selected meter. All measurement attributes of the previous function (range, resolution, etc.) are remembered. If you return to the previous function, the measurement attributes are restored.

Changing the measurement type disables scaling, limit testing, histogram, statistics, and trend chart data collection: CALC:<function>:STAT is set OFF.

Suffix:

<m> 1..4
 Selects the voltmeter.

Setting parameters:

<MeasType> 'VOLTage:AC | VOLTage[:DC] | VOLTage:AD'
 String parameter
 *RST: VOLTage [:DC]

Example:

```
MET2:SENS:FUNC "VOLT:AC"
MET2:CONF:VAL?
<--"VOLT:AC 1"
```

Sets the second voltmeter to AC voltage measurement.

Usage:

Setting only

METer<m>:CONFigure:VALue?

Returns the actual measurement type (short form) and the range.

Suffix:

<m> 1..4
Selects the voltmeter.

Return values:

<Configuration> String parameter

Example:

```
MET:CONF:VAL?
<-- "VOLT:DC 100"
```

The first voltmeter is set to DC voltage measurement and range 100 V.

Usage: Query only

METer<m>:TRIGger:MODE <TriggerMode>

Defines how long the instrument measures. To start the measurement again, use RUN or the appropriate METer<m>:MEASure:<function> command.

Suffix:

<m> 1..4
R&S RTH1002: always 1, omit the suffix
R&S RTH1004: Selects the voltmeter.

Parameters:

<TriggerMode> AUTO | SINGLE

AUTO

The instrument performs continuous measurements.

SINGLE

The instrument performs a single measurement.

*RST: AUTO

METer<m>:ABORt

Stops the running measurement.

Suffix:

<m> 1..4
R&S RTH1002: always 1, omit the suffix
R&S RTH1004: Selects the voltmeter.

Usage: Event

14.8.5 Results

- [Reading Values](#).....355
- [METer:MEASure Commands](#).....356
- [Statistics](#).....357

14.8.5.1 Reading Values

METer<m>:INITiate	355
METer<m>:READ?	355
METer<m>:FETCh?	355

METer<m>:INITiate

Resets the hardware and all statistical values, performs a single measurement and ends in hold mode.

Suffix:

<m> 1..4

Usage: Event

METer<m>:READ?

Starts a new measurement, returns the current measurement result and stays in run mode.

Suffix:

<m> 1..4
 R&S RTH1002: always 1, omit the suffix
 R&S RTH1004: Selects the voltmeter.

Return values:

<Meter result>

Usage: Query only

METer<m>:FETCh?

Returns the currently measured value.

Use this command after [METer<m>:INITiate](#).

Suffix:

<m> 1..4
 R&S RTH1002: always 1, omit the suffix
 R&S RTH1004: Selects the voltmeter.

Return values:

<Result> Range: -100E+24 to 100E+24
 Increment: 0
 *RST: 0
 Default unit: V

Example:

```
MEtEr:INITiate
MEtEr:FETCh?
<-- 999.98564109
```

Usage: Query only

14.8.5.2 METer:MEASure Commands

Sending a `MEtEr:MEASure:<function>?` command is the same as sending the `MEtEr:CONFigure:<function>` command followed immediately by a `READ?` command.

<code>MEtEr<m>:MEASure:CURRent:AC?</code>	356
<code>MEtEr<m>:MEASure:CURRent:DC?</code>	356
<code>MEtEr<m>:MEASure:VOLTage:AC?</code>	356
<code>MEtEr<m>:MEASure:VOLTage:DC?</code>	356

MEtEr<m>:MEASure:CURRent:AC? [<ExpectedValue>]

MEtEr<m>:MEASure:CURRent:DC? [<ExpectedValue>]

Configures the current measurement and returns the result.

Suffix:

<m> 1..4
 Selects the voltmeter.

Query parameters:

[<ExpectedValue>] <numeric value> | MIN | MAX | DEF

Optional parameter, expected measurement result or range. The instrument sets the appropriate measurement range.

See: [MEtEr<m>:CONFigure:CURRent:DC](#).

Return values:

<Result> Numeric value

Usage: Query only

MEtEr<m>:MEASure:VOLTage:AC? [<ExpectedValue>]

MEtEr<m>:MEASure:VOLTage:DC? [<ExpectedValue>]

Configures the voltage measurement and returns the result.

Suffix:

<m> 1..4
 Selects the voltmeter.

Query parameters:

[<ExpectedValue>] <numeric value> | MIN | MAX | DEF

Optional parameter, expected measurement result or range. The instrument sets the appropriate measurement range.

See: [METer<m>:CONFIgure:VOLTagE:DC](#).

Return values:

<Result> Numeric value

Usage: Query only**14.8.5.3 Statistics**

Before you can get statistical results, configure the measurement and select the measurement to be performed using [METer<m>:SENSe:FUNCTion](#).

METer<m>:CALCulate:AVERage:AVERage?	357
METer<m>:CALCulate:AVERage:MINimum?	357
METer<m>:CALCulate:AVERage:MAXimum?	358
METer<m>:CALCulate:AVERage:CLEar	358

METer<m>:CALCulate:AVERage:AVERage?

Returns the mean value of the measurement series.

Suffix:

<m> 1..4
 R&S RTH1002: always 1, omit the suffix
 R&S RTH1004: Selects the voltmeter.

Return values:

<Average> Range: -100E+24 to 100E+24
 Increment: 1E-12
 *RST: 0
 Default unit: V

Usage: Query only**METer<m>:CALCulate:AVERage:MINimum?**

Returns the minimum value of the measurement series.

Suffix:

<m> 1..4
 R&S RTH1002: always 1, omit the suffix
 R&S RTH1004: Selects the voltmeter.

Return values:

<Minimum> Range: -100E+24 to 100E+24
 Increment: 1E-12
 *RST: 0
 Default unit: V

Usage: Query only

METer<m>:CALCulate:AVERage:MAXimum?

Returns the maximum value of the measurement series.

Suffix:

<m> 1..4
 R&S RTH1002: always 1, omit the suffix
 R&S RTH1004: Selects the voltmeter.

Return values:

<Maximum> Range: -100E+24 to 100E+24
 Increment: 1E-12
 *RST: 0
 Default unit: V

Usage: Query only

METer<m>:CALCulate:AVERage:CLEar

Deletes all statistical values.

Statistics are also deleted if:

- The measurement function changes (METer:SENSE:FUNCTION).
- *RST
- SYSTem:PRESet

Suffix:

<m> 1..4
 R&S RTH1002: always 1, omit the suffix
 R&S RTH1004: Selects the voltmeter.

Usage: Event

14.9 Counter Mode (R&S RTH-K33)

COUNter<m>:ABORT.....	359
COUNter<m>:CALCulate:AVERage:ALL?.....	359
COUNter<m>:CALCulate:AVERage:AVERage?.....	359
COUNter<m>:CALCulate:AVERage:CLEar.....	359
COUNter<m>:CALCulate:AVERage:COUNt:CURRent?.....	360
COUNter<m>:CALCulate:AVERage:MAXimum?.....	360
COUNter<m>:CALCulate:AVERage:MINimum?.....	360
COUNter<m>:CONFigure:FREQuency.....	361
COUNter<m>:CONFigure:VALue?.....	361
COUNter<m>:FETCh?.....	361
COUNter<m>:INITiate.....	362
COUNter<m>:MEASure:FREQuency?.....	362

COUNter<m>:READ?	363
COUNter<m>:SENSe:FUNcTION	363
COUNter<m>:SENSe:RANGe	363
COUNter<m>:SENSe:REFerence:STATe	363
COUNter<m>:SENSe:REFerence:VALue	364
COUNter<m>:SENSe:SOURce	364
COUNter<m>:SENSe:STATe	364
COUNter<m>:SENSe:TRIGger:MODE	364

COUNter<m>:ABORT

Aborts a running measurement and switches to single measurement mode.

Suffix:

<m> 1..2

Usage: Event

COUNter<m>:CALCulate:AVERage:ALL?

Queries the statistical results of all measured counter frequencies since statistics were last restarted.

Suffix:

<m> 1..2

Return values:

<All statistics> Minimum, average, maximum value

Usage: Query only

COUNter<m>:CALCulate:AVERage:AVERage?

Queries the average of all measured counter frequencies since statistics were last restarted.

Suffix:

<m> 1..2

Return values:

<Average> Average measured value
 Range: -100E+24 to 100E+24
 Increment: 1E-12
 *RST: 0
 Default unit: Hz

Usage: Query only

COUNter<m>:CALCulate:AVERage:CLEar

Resets all statistical values.

Suffix:
 <m> 1..2

Usage: Event

COUNTER<m>:CALCulate:AVERage:COUNT:CURRENT?

Returns the number of counter frequencies included in the averaging process.

Suffix:
 <m> 1..2

Return values:
 <NumberOfValues> Range: 0 to 4294967295
 Increment: 1
 *RST: 0

Usage: Query only

COUNTER<m>:CALCulate:AVERage:MAXimum?

Queries the maximum of all measured counter frequencies since statistics were last restarted.

Suffix:
 <m> 1..2

Return values:
 <Maximum> Average measured value
 Range: -100E+24 to 100E+24
 Increment: 1E-12
 *RST: 0
 Default unit: Hz

Usage: Query only

COUNTER<m>:CALCulate:AVERage:MINimum?

Queries the minimum of all measured counter frequencies since statistics were last restarted.

Suffix:
 <m> 1..2

Return values:
 <Minimum> Average measured value
 Range: -100E+24 to 100E+24
 Increment: 1E-12
 *RST: 0
 Default unit: Hz

Usage: Query only

COUNter<m>:CONFigure:FREQuency <Range>

This command sets all measurement parameters and trigger parameters to default values for frequency measurements.

Note: this command can be executed at any time, even if the counter is not yet activated. The parameters are stored internally and used when the counter is activated.

Suffix:

<m> 1..2

Parameters:

<Range> <numeric value> | MIN | MAX | DEF

Defines the measurement range of the input signal for the counter. If probes are connected, the MIN | MAX | DEF values are adapted accordingly.

<numeric value>

Power range in V. If necessary, the next higher range is selected.

MIN

100 mV

MAX

300 V

DEF

100 mV

Usage: Setting only

COUNter<m>:CONFigure:VALue?

Returns the current configuration for the counter measurement defined by the most recent `COUNter<m>:CONFigure:FREQuency` or `COUNter<m>:MEASure:FREQuency?` command.

Suffix:

<m> 1..2

Return values:

<ConfigString> String containing the current measurement function (FREQ) and the defined measurement range of the used input channel.

Example:

```
COUN1:CONF:VAL?
//Result: 'FREQ 3V'
```

Usage: Query only

COUNter<m>:FETCh?

Queries the currently measured value.

Suffix:

<m> 1..2

Return values:

<ResultActual> Measured value
 Range: -100E+24 to 100E+24
 Increment: 0
 *RST: 0
 Default unit: Hz

Usage: Query only

COUNter<m>:INITiate

Resets the hardware and all statistical values, performs a single measurement and ends in hold mode.

Suffix:

<m> 1..2

Usage: Event

COUNter<m>:MEASure:FREQuency? <Range>

This command sets all measurement parameters and trigger parameters to default values for frequency measurements, then immediately triggers a counter measurement and returns the result.

This command corresponds to the commands `COUNter<m>:CONFigure:FREQuency` + `COUNter<m>:FETCh?`

Suffix:

<m> 1..2

Parameters:

<Range> <numeric value> | MIN | MAX | DEF

Defines the measurement range of the input signal for the counter. If probes are connected, the MIN | MAX | DEF values are adapted accordingly.

<numeric value>

Power range in V. If necessary, the next higher range is selected.

MIN

100 mV

MAX

300 V

DEF

100 mV

Return values:

<Counter result> Measured frequency

Usage: Query only

COUNter<m>:READ?

Starts a new measurement, returns the current measurement result and stays in run mode.

Suffix:

<m> 1..2

Return values:

<Counter result> Measured frequency

Usage: Query only

COUNter<m>:SENSe:FUNctIon [<Function>]

Selects the input channel for the counter.

Suffix:

<m> 1..2

Parameters:

<Function> 'FREQ 1' | 'FREQ 2' | 'FREQ 3' | 'FREQ 4'
Depends on available channels.

COUNter<m>:SENSe:RANGe <MeterRangeUI>

This command defines the measurement range.

Suffix:

<m> 1..2

Parameters:

<MeterRangeUI> Range: 0.1 to 300
Increment: 0.1
*RST: 0.1

COUNter<m>:SENSe:REFerence:STATe <ReferenceSource>

Selects the reference to be used for the counter.

Suffix:

<m> 1..2

Parameters:

<ReferenceSource> INTernal | EXTernal

EXTernal

The measured value of counter 2 is used as a reference. Specify the nominal reference frequency for counter 2 using

`COUNTer<m>:SENSe:REFerence:VALue`.

INTernal

An internal reference is used to determine the counter frequency.

*RST: INTernal

COUNTer<m>:SENSe:REFerence:VALue <RefFreq>

Defines the nominal frequency value to be used as a reference for counter 2.

Suffix:

<m> 1..2

Parameters:

<RefFreq> Range: 10 to 500E+6
 Increment: 1
 *RST: 10E+6
 Default unit: Hz

COUNTer<m>:SENSe:SOURce <InputChannel>

Selects the channel used for input for the selected counter.

Suffix:

<m> 1..2

Parameters:

<InputChannel> C1 | C2 | C3 | C4
 *RST: C1

COUNTer<m>:SENSe:STATe <State>

Activates or deactivates the counter.

Suffix:

<m> 1..2

Parameters:

<State> ON | OFF
 *RST: OFF

COUNTer<m>:SENSe:TRIGger:MODE <TriggerMode>

Determines the measurement mode.

Suffix:
 <m> 1..2

Parameters:
 <TriggerMode> AUTO | SINGle

AUTO
 Continuous measurement; the most recent value is preserved and displayed, while the oldest value are overwritten

SINGle
 Single measurement; the continuous measurement is stopped and the most recent value is preserved.

*RST: AUTO

14.10 Data Logging

- [Logger Settings](#)..... 365
- [Cursor in Logger Mode](#)..... 367
- [Zoom in Logger mode](#)..... 369
- [Logger Statistics](#)370
- [Logger Records](#).....373

14.10.1 Logger Settings

LOGGer:SOURce	365
LOGGer:TIMEbase:SRATe	365
LOGGer:TIMEbase:SCALe	366
LOGGer:SLOT:CURRent	366
LOGGer:SLOT:LOAD	366
LOGGer:SLOT:CLEar	366
LOGGer:ACLR	367

LOGGer:SOURce <Source>

Sets the logger source.

Parameters:

<Source> SCOPe | METer | COUNter

SCOPe: an active automatic measurement is required.
 METer | COUNter: The selected measurement must be active, but not running.

LOGGer:TIMEbase:SRATe <NextSampleRate>

Sets the number of samples per second.

Parameters:

<NextSampleRate> SA1 | SA2 | SA5 | SA10
 *RST: SA1

LOGGer:TIMEbase:SCALE <NextHorizScale>

Selects the horizontal scale of the logged data.

Parameters:

<NextHorizScale> AUTO | S1 | S2 | S4 | S5 | S10 | S20 | S40 | M1 | M2 | M4 | M5 |
 M10 | M20 | M40 | H1 | H2 | H4 | H5 | H10 | H20 | D1 | D2 | D4
S1 | S2 | S4 | S5 | S10 | S20 | S40
 Seconds per division
M1 | M2 | M4 | M5 | M10 | M20 | M40
 Minutes per division
H1 | H2 | H4 | H5 | H10 | H20
 Hours per division
D1 | D2 | D4
 Days per division
 *RST: AUTO

LOGGer:SLOT:CURRent <SelectedSlot>

Selects one of the 10 memory slots to store the data during the logging. It is possible to change the slot during recording.

Parameters:

<SelectedSlot> SLOT1 | SLOT2 | SLOT3 | SLOT4 | SLOT5 | SLOT6 | SLOT7 |
 SLOT8 | SLOT9 | SLOT10
 *RST: SLOT1

LOGGer:SLOT:LOAD

Loads the logger record of a slot, and activates the slot. The slot is defined using [LOGGer:SLOT:CURRent](#).

Usage: Event

LOGGer:SLOT:CLEar

Deletes the log data of a slot. The slot is defined using [LOGGer:SLOT:CURRent](#).

Only possible while logging is stopped.

Usage: Event

LOGGer:ACLR

Deletes the log data of all slots. Only possible while logging is stopped.

Usage: Event

14.10.2 Cursor in Logger Mode**14.10.2.1 Cursor Settings**

LOGGer:CURSor:STATe.....	367
LOGGer:CURSor:TYPE.....	367
LOGGer:CURSor:SCPLing.....	367
LOGGer:CURSor:COUPling.....	368
LOGGer:CURSor:SCReen.....	368

LOGGer:CURSor:STATe <Enabled>

Enables or disables the logger cursor measurement.

Parameters:

<Enabled> ON | OFF
*RST: OFF

LOGGer:CURSor:TYPE <Value>

If data logging is running for more than 2 days and 7 hours, the logger compresses 4 logging values into a minimum, average and maximum value. The command defines which of these values are measured at the cursor position.

For logging periods shorter than 2 days and 7 hours, the command is not relevant.

Parameters:

<Value> MINimum | AVERage | MAXimum
*RST: AVERage

LOGGer:CURSor:SCPLing <TrackScaling>

If ON, the position of the cursor lines is adjusted when the horizontal scale is changed. If OFF, the cursor lines remain on their position on the display when the scaling is changed.

Parameters:

<TrackScaling> ON | OFF
*RST: OFF

LOGGer:CURSor:COUPling <Coupling>

Couples the cursor lines so that the distance between the two lines remains the same when one cursor is moved.

Parameters:

<Coupling> ON | OFF
*RST: OFF

LOGGer:CURSor:SCReen

Sets the cursors to a default position on the screen.

Usage: Event

14.10.2.2 Cursor Results

LOGGer:CURSor<m>:RESult<n>[:AMPLitude]?	368
LOGGer:CURSor:RESult<n>:DELTA?	368
LOGGer:CURSor<m>:POSition?	369
LOGGer:CURSor:TDELta?	369

LOGGer:CURSor<m>:RESult<n>[:AMPLitude]?

Returns the measured value at the specified cursor line (y1 and y2 on the result display).

Suffix:

<m> 1..2
 Specifies the cursor line.

<n> 1..4
 Specifies the measurement. You can log the results of up to four active measurements.

Return values:

<Yvalue> Measurement value

Usage: Query only

LOGGer:CURSor:RESult<n>:DELTA?

Returns the difference of the measured values at cursor line 1 and cursor line 2 (Δy on the result display).

Suffix:

<n> 1..4
 Specifies the measurement. You can log the results of up to four active measurements.

Return values:

<ResultDelta> Absolute value of the result difference.

Usage: Query only

LOGGer:CURSor<m>:POSition?

Returns the timestamp (absolute time) of the specified cursor line (t1 and t2 on the result display).

Suffix:

<m> 1..2
Specifies the cursor line.

Return values:

<Time> List of values:
<Year>;<Month>;<Day>;<Hour>;<Minute>;<Second>;<TenthsOfSec
Year, month, day, hour, minute, second, tenth of a second, for
example 2015,10,29,16,10,22,2

Usage: Query only

LOGGer:CURSor:TDELta?

Returns the time difference of the cursor lines (t1 and t2 on the result display).

Return values:

<DeltaTime> List of values:
<Day>;<Hour>;<Minute>;<Second>;<TenthsOfSecond>
Days, hours, minutes, seconds, tenth of a second, for example
1,9,10,22,5

Usage: Query only

14.10.3 Zoom in Logger mode

LOGGer:ZOOM:ENABLE.....	369
LOGGer:ZOOM:SCALE.....	369
LOGGer:Zoom:POSition?.....	370

LOGGer:ZOOM:ENABLE <Zoom Enabled>

Enables or disables the logger zoom.

Parameters:

<Zoom Enabled> ON | OFF
*RST: OFF

LOGGer:ZOOM:SCALE <Zoom Scale>

Sets the time scale of the zoomed waveform.

Parameters:

<Zoom Scale> AUTO | S1 | S2 | S4 | S5 | S10 | S20 | S40 | M1 | M2 | M4 | M5 | M10 | M20 | M40 | H1 | H2 | H4 | H5 | H10 | H20 | D1 | D2 | D4

LOGGer:Zoom:POStion?

Returns the position of the left edge of the zoomed area in relation to the left side of the display.

Suffix:

<m> 1..2
Specifies the cursor line.

Return values:

<Time> List of values:
<Year>;<Month>;<Day>;<Hour>;<Minute>;<Second>;<TenthsOfSec>
Year, month, day, hour, minute, second, tenth of a second, for example 2015,10,29,16,10,22,2

Usage: Query only

14.10.4 Logger Statistics

The suffix <m> specifies the measurement that is logged.

LOGGer:RECOding:STARt?	370
LOGGer:RECOding:TOTal?	370
LOGGer:MEASurement<m>:RESult:CURRentsampl?	371
LOGGer:MEASurement<m>:RESult:MAXimum:POStion?	371
LOGGer:MEASurement<m>:RESult:MAXimum:VALue?	371
LOGGer:MEASurement<m>:RESult:MINimum:POStion?	371
LOGGer:MEASurement<m>:RESult:MINimum:VALue?	372
LOGGer:MEASurement<m>:RESult:MEAN?	372
LOGGer:MEASurement<m>:RESult:STDDev?	372
LOGGer:MEASurement<m>:ENABled?	372
LOGGer:MEASurement<m>:TYPE?	373
LOGGer:MEASurement<m>:SOURce?	373

LOGGer:RECOding:STARt?

Returns the absolute start time of the current logging session.

Return values:

<StartTime> Year, month, day, hour, minute, second, tenth of a second, for example 2015,10,29,16,10,22,2

Usage: Query only

LOGGer:RECOding:TOTal?

Returns the total duration of the current logging session.

Return values:

<Time> List of values:
 <Days>;<Hours>;<Minutes>;<Seconds>;<TenthsOfSecond>
 For example: 1;1;42;32;2

Usage: Query only

LOGGer:MEASurement<m>:RESult:CURRentsampl?

Returns the actual logging value of the selected measurement.

Suffix:

<m> 1..4

Return values:

<CurrentSample> Range: -100E+24 to 100E+24
 Increment: 100E-12
 *RST: 0

Usage: Query only

LOGGer:MEASurement<m>:RESult:MAXimum:POSition?

Returns the time stamp of the maximum logging value of the selected measurement.

Suffix:

<m> 1..4

Return values:

<TimeOfMax>

Usage: Query only

LOGGer:MEASurement<m>:RESult:MAXimum:VALue?

Returns the maximum logging value of the selected measurement.

Suffix:

<m> 1..4

Return values:

<Maximum> Range: -100E+24 to 100E+24
 Increment: 100E-12
 *RST: 0

Usage: Query only

LOGGer:MEASurement<m>:RESult:MINimum:POSition?

Returns the time stamp of the minimum logging value of the selected measurement.

Suffix:

<m> 1..4

Return values:

<TimeOfMin>

Usage: Query only**LOGGer:MEASurement<m>:RESult:MINimum:VALue?**

Returns the minimum logging value of the selected measurement.

Suffix:

<m> 1..4

Return values:

<Minimum>	Range:	-100E+24 to 100E+24
	Increment:	100E-12
	*RST:	0

Usage: Query only**LOGGer:MEASurement<m>:RESult:MEAN?**

Returns the mean logging value of the selected measurement.

Suffix:

<m> 1..4

Return values:

<Average>	Range:	-100E+24 to 100E+24
	Increment:	100E-12
	*RST:	0

Usage: Query only**LOGGer:MEASurement<m>:RESult:STDDev?**

Returns the standard deviation value of the selected measurement.

Suffix:

<m> 1..4

Return values:

<StdDeviation>	Range:	-100E+24 to 100E+24
	Increment:	100E-12
	*RST:	0

Usage: Query only**LOGGer:MEASurement<m>:ENABLEd?**

Returns the measurement state of scope and meter measurements.

Suffix:

<m> 1..4

Return values:
 <Enabled> ON | OFF
 *RST: OFF
Usage: Query only

LOGGer:MEASurement<m>:TYPE?

Returns the measurement type of the selected measurement.

Suffix:
 <m> 1..4

Return values:
 <Type> See [MEASurement<m>:TYPE](#) on page 288.

Usage: Query only

LOGGer:MEASurement<m>:SOURce?

Returns the source channel of the selected measurement.

Suffix:
 <m> 1..4

Return values:
 <Source> C1 | C2 | C3 | C4 | M1 | R1 | XY | D0 | D1 | D2 | D3 | D4 | D5 | D6 | D7
 <Source2> C1 | C2 | C3 | C4 | M1 | R1 | XY | D0 | D1 | D2 | D3 | D4 | D5 | D6 | D7

Example:
 LOGGer:MEASurement4:SOURce?
 <-- C2,C1
 Measurement 4 is a delay measurement on source 1 = C2 and source 2 = C1

Usage: Query only

14.10.5 Logger Records

You can export the data of an active slot to a file, in CSV or MAT format. See also: [Chapter 7.6, "Logger Records"](#), on page 156.

LOGGer:SLOT:ACTive?	373
LOGGer:SLOT:EXPort:NAME	374
LOGGer:SLOT:EXPort:SAVE	374

LOGGer:SLOT:ACTive?

Returns the active slot. The active slot is the slot where logger data is stored, and the data is loaded for display.

Return values:

<LoadedSlot> SLOT1 | SLOT2 | SLOT3 | SLOT4 | SLOT5 | SLOT6 | SLOT7 |
SLOT8 | SLOT9 | SLOT10
*RST: SLOT1

Usage: Query only

LOGGer:SLOT:EXPort:NAME <Name>

Sets the file name, file format and path to save the logger record.

Parameters:

<Name> String with path and file name with extension .csv or .mat.

LOGGer:SLOT:EXPort:SAVE

Saves the logger record of the active slot to the file specified with **LOGGer:SLOT:EXPort:NAME**. The active slot is queried with **LOGGer:SLOT:ACTive?**.

Example:

```
RUN
LOGGer:SLOT:CURRent SLOT2
STOP
LOGGer:SLOT:ACTive?
<-- SLOT2
LOGGer:SLOT:EXPort:NAME '/media/USB1/SLOT2.MAT'
LOGGer:SLOT:EXPort:SAVE
```

Usage: Event

14.11 Protocol Analysis

- [General Protocol Settings](#)..... 374
- [I2C \(Option R&S RTH-K1\)](#)..... 375
- [SPI \(Option R&S RTH-K1\)](#)..... 385
- [UART/RS-232/RS-422/RS-485 \(Option R&S RTH-K2\)](#)..... 393
- [CAN \(Option R&S RTH-K3\)](#)..... 399
- [LIN \(Option R&S RTH-K3\)](#)..... 411

14.11.1 General Protocol Settings

- [BUS:TYPE](#)..... 374
- [BUS\[:STATe\]](#)..... 375
- [BUS:FORMat](#)..... 375

BUS:TYPE <Protocol>

Defines protocol type of the bus for configuration and trigger settings.

Parameters:

<Protocol> I2C | SPI | UART | CAN | LIN
 *RST: I2C

BUS[:STATe] <State>

Enables the decoding and the display of the serial bus data.

Parameters:

<State> ON | OFF
 *RST: OFF

BUS:FORMat <NumberFormat>

Sets the decoding format of the data.

Parameters:

<NumberFormat> BIN | OCT | DEC | HEX | ASCii
 *RST: HEX

14.11.2 I2C (Option R&S RTH-K1)

- [I2C Configuration Settings](#)..... 375
- [I2C Trigger](#)..... 376
- [I2C Decode Results](#)..... 379

14.11.2.1 I2C Configuration Settings

BUS:I2C:SCL:SOURce	375
BUS:I2C:SDA:SOURce	375
BUS:I2C:TECHnology	376
BUS:I2C:SCL:THReshold	376
BUS:I2C:SDA:THReshold	376
BUS:SETReflevels	376

BUS:I2C:SCL:SOURce <Channel>

BUS:I2C:SDA:SOURce <Channel>

Set the input channels of the I2C lines.

Parameters:

<Channel> C1 | C2 | C3 | C4 | D0 | D1 | D2 | D3 | D4 | D5 | D6 | D7
 C3 and C4: only R&S RTH1004
 Digital channels are available if option R&S RTH-B1 is installed.
 *RST: C1

BUS:I2C:TECHnology <ThresholdType>

Sets the threshold values of all I2C lines as defined for various signal technologies.

Parameters:

<ThresholdType> TTL | ECL | CMOS | USER

TTL

1.4 V

ECL

-1.3 V

CMOS

2.5 V

USER

Set a user-defined value for each line using the

BUS:I2C:<line>:THReshold commands.

*RST: TTL

Usage: SCPI confirmed

BUS:I2C:SCL:THReshold <ThresholdValue>**BUS:I2C:SDA:THReshold** <ThresholdValue>

Set a user-defined threshold value for the corresponding line if **BUS:I2C:TECHnology** is set to **USER**.

Parameters:

<ThresholdValue> Range: -400 to 400

Increment: 1E-3

*RST: 1.4

Default unit: V

BUS:SETReflevels

Sets the appropriate threshold or threshold for the selected serial protocol.

Usage: Event

14.11.2.2 I2C Trigger

TRIGger:I2C:MODE.....	377
TRIGger:I2C:ADNack.....	377
TRIGger:I2C:DRNack.....	377
TRIGger:I2C:DWNack.....	377
TRIGger:I2C:ACcEss.....	377
TRIGger:I2C:ACONdition.....	378
TRIGger:I2C:ADDResS.....	378
TRIGger:I2C:DATA.....	378
TRIGger:I2C:DcONdition.....	378
TRIGger:I2C:DPOsition.....	379

TRIGger:I2C:MODE <TriggerType>

Selects the trigger type for I²C analysis.

Parameters:

<TriggerType> START | REStart | STOP | NACK | ADDRess | DATA | ADAT

NACK = Missing acknowledge bit

ADAT = combination of address and data condition

For details, see "I²C Trigger" on page 170.

*RST: START

TRIGger:I2C:ADNack <TrigOnNoAckForAddress>

Set ON to trigger if no slave recognizes the address.

The command takes effect if **TRIGger:I2C:MODE** is NACK.

Parameters:

<TrigOnNoAckForAddress> ON | OFF

*RST: ON

TRIGger:I2C:DRNack <NoAckDataRead>

Set ON to trigger if the end of the read process is marked when the master reads data from the slave. This Nack is sent according to the protocol definition, it is not an error.

The command takes effect if **TRIGger:I2C:MODE** is NACK.

Parameters:

<NoAckDataRead> ON | OFF

*RST: ON

TRIGger:I2C:DWNack <NoAckDataWrite>

Set ON to trigger if the addressed slave does not accept the written data, and the write data acknowledge bit is missing.

The command takes effect if **TRIGger:I2C:MODE** is NACK.

Parameters:

<NoAckDataWrite> ON | OFF

*RST: ON

TRIGger:I2C:ACCess <ReadWriteBit>

Toggles the trigger condition between read and write access of the master. Select "Either" if the transfer direction is not relevant for the trigger condition.

The command takes effect if **TRIGger:I2C:MODE** is ADDRess or ADAT.

Parameters:

<ReadWriteBit> READ | WRITe | EITHer
 *RST: EITHer

TRIGger:I2C:ACONdition <Relation>

Defines how the specified serial address pattern is compared with the acquired signal. The instrument triggers if the acquired address is equal or unequal to the pattern.

Parameters:

<Relation> EQUal | NEQual
 *RST: EQUal

TRIGger:I2C:ADDRess <Pattern>

Specifies the address pattern to be found, in binary format. Enter the pattern in MSB first bit order.

Parameters:

<Pattern> String with max. 7 or 10 characters, depending on the address length. Characters 0, 1, and X are allowed. If you define a pattern shorter than the address length, the missing LSB are filled with X.

Example:

```
TRIG:I2C:ADDR "10110"
Sets the 7 bit address pattern 10110XX.
```

TRIGger:I2C:DATA <Pattern>

Defines the data pattern as trigger condition. Enter the words in MSB first bit order.

Parameters:

<Pattern> String with max. 4 bytes in binary format. Characters 0, 1, and X are allowed. If you define a pattern with incomplete byte, the missing LSB are filled with X.

Example:

```
TRIGger:I2C:DATA '11111111000000001111'
TRIGger:I2C:DATA?
<-- 11111111000000001111XXXX
```

TRIGger:I2C:DCONDITION <Relation>

Defines how the specified data pattern is compared with the acquired signal. The instrument triggers if the acquired data is equal or unequal to the pattern.

Parameters:

<Relation> EQUal | NEQual
 *RST: EQUal

TRIGger:I2C:DPOsition <ByteOffset>

Sets the number of bytes before the first byte of the data pattern. These bytes are ignored.

Parameters:

<ByteOffset>	Range:	0 to 4095
	Increment:	1
	*RST:	0

14.11.2.3 I2C Decode Results

The frame suffix <m> selects the frame index for which the result is queried.

The byte suffix <n> selects the byte index for which the result is queried.

BUS:I2C:FCOunt?	379
BUS:I2C:FRAMe<m>:AACcess?	380
BUS:I2C:FRAMe<m>:ACCess?	380
BUS:I2C:FRAMe<m>:ACOMplete?	380
BUS:I2C:FRAMe<m>:ADBStart?	380
BUS:I2C:FRAMe<m>:ADDRes?	381
BUS:I2C:FRAMe<m>:ADEvice?	381
BUS:I2C:FRAMe<m>:AMODE?	381
BUS:I2C:FRAMe<m>:ASTart?	381
BUS:I2C:FRAMe<m>:BCOunt?	382
BUS:I2C:FRAMe<m>:BYTE<n>:ACCess?	382
BUS:I2C:FRAMe<m>:BYTE<n>:ACKStart?	382
BUS:I2C:FRAMe<m>:BYTE<n>:COMplete?	382
BUS:I2C:FRAMe<m>:BYTE<n>:STARt?	383
BUS:I2C:FRAMe<m>:BYTE<n>:VALue?	383
BUS:I2C:FRAMe<m>:DATA?	383
BUS:I2C:FRAMe<m>:RWBStart?	383
BUS:I2C:FRAMe<m>:STARt?	384
BUS:I2C:FRAMe<m>:STATus?	384
BUS:I2C:FRAMe<m>:STOP?	385

BUS:I2C:FCOunt?

Returns the number of decoded frames.

Return values:

<Count>	Total number of decoded frames.
	Range: 0 to 100000
	Increment: 1
	*RST: 0

Usage: Query only

BUS:I2C:FRAME<m>:AACcess?

Returns the address acknowledge bit value for the indicated frame.

Suffix:

<m> *

Return values:

<AddressAckBit> INComplete | ACK | NACK | EITHer
*RST: INComplete

Usage: Query only

BUS:I2C:FRAME<m>:ACCess?

Returns the value of the R/W bit of the indicated frame.

Suffix:

<m> *

Return values:

<RWBit> READ | WRITe | EITHer | UNDeFined
*RST: UNDeFined

Usage: Query only

BUS:I2C:FRAME<m>:ACOMplete?

Returns if the address is completely contained in the acquisition.

Suffix:

<m> *

Return values:

<AddressComplete> 1 | 0
*RST: OFF

Usage: Query only

BUS:I2C:FRAME<m>:ADBStart?

Returns the start time of the address acknowledge bit.

Suffix:

<m> *

Return values:

<AddressAckBitStart> Range: -100E+24 to 100E+24
Increment: 100E-12
*RST: 0
Default unit: s

Usage: Query only

BUS:I2C:FRAME<m>:ADDRess?

Returns the address value of the indicated frame including the R/W bit.

Suffix:

<m> *

Return values:

<Address> Range: 0 to 2047
Increment: 1
*RST: 0

Usage: Query only

BUS:I2C:FRAME<m>:ADEVice?

Returns the pure device address of the indicated frame without the R/W bit.

Suffix:

<m> *

Return values:

<DeviceAddress> Range: 0 to 1023
Increment: 1
*RST: 0

Usage: Query only

BUS:I2C:FRAME<m>:AMODE?

Returns the address length.

Suffix:

<m> *

Return values:

<AddressType> BIT7 | BIT10 | ANY
*RST: BIT7

Usage: Query only

BUS:I2C:FRAME<m>:ASStart?

Returns the start time of the address for the indicated frame.

Suffix:

<m> *

Return values:

<AddressStartTime> Range: -100E+24 to 100E+24
Increment: 100E-12
*RST: 0
Default unit: s

Usage: Query only

BUS:I2C:FRAME<m>:BCOunt?

Returns the number of bytes in the specified frame.

Suffix:
<m> *

Return values:
<Count> Byte count

Usage: Query only

BUS:I2C:FRAME<m>:BYTE<n>:ACCess?

Returns the acknowledge bit value of the specified data byte.

Suffix:
<m> *
<n> *

Return values:
<AckBit> INComplete | ACK | NACK | EITHer
*RST: INComplete

Usage: Query only

BUS:I2C:FRAME<m>:BYTE<n>:ACKStart?

Returns the start time of the acknowledge bit of the specified byte.

Suffix:
<m> *
<n> *

Return values:
<AckBitStartTime> Range: -100E+24 to 100E+24
Increment: 100E-12
*RST: 0
Default unit: s

Usage: Query only

BUS:I2C:FRAME<m>:BYTE<n>:COMPLete?

Returns if the indicated byte is completely contained in the acquisition.

Suffix:
<m> *
<n> *

Return values:

<IsComplete> 1 | 0
 *RST: OFF

Usage: Query only

BUS:I2C:FRAME<m>:BYTE<n>:START?

Returns the start time of the specified data byte.

Suffix:

<m> *
 <n> *

Return values:

<StartTime> Range: -100E+24 to 100E+24
 Increment: 100E-12
 *RST: 0
 Default unit: s

Usage: Query only

BUS:I2C:FRAME<m>:BYTE<n>:VALue?

Returns the data value of the specified byte.

Suffix:

<m> *
 <n> *

Return values:

<Value> Range: 0 to 255
 Increment: 1
 *RST: 0

Usage: Query only

BUS:I2C:FRAME<m>:DATA?

Returns the data words of the specified frame.

Suffix:

<m> *

Parameters:

<Data> Comma-separated list of values.

Usage: Query only

BUS:I2C:FRAME<m>:RWBStart?

Returns the start time of the R/W bit

Suffix:

<m> *

Return values:

<RWBitStartTime> Range: -100E+24 to 100E+24
Increment: 100E-12
*RST: 0
Default unit: s

Usage: Query only

BUS:I2C:FRAMe<m>:STARt?

Returns the start time of the specified frame.

Suffix:

<m> *

Return values:

<StartTime> Range: -100E+24 to 100E+24
Increment: 100E-12
*RST: 0
Default unit: s

Usage: Query only

BUS:I2C:FRAMe<m>:STATus?

Returns the overall state of the frame.

Suffix:

<m> *

Return values:

<Status>	OK VOID ADNack WRNack SPERror STERror INSufficient
	OK The frame is valid.
	VOID The frame is empty.
	ADNack Missing acknowledge bit after address - no slave recognizes the address.
	WRNack Missing acknowledge bit after written data - the addressed slave does not accept the written data.
	SPERror Stop error, no stop condition found.
	STERror Start error, no start condition found.
	INSufficient The frame is not completely contained in the acquisition. The acquired part of the frame is valid.
	*RST: OK

Usage: Query only

BUS:I2C:FRAME<m>:STOP?

Returns the end time of the specified frame.

Suffix:

<m> *

Return values:

<StopTime>	Range: -100E+24 to 100E+24
	Increment: 100E-12
	*RST: 0
	Default unit: s

Usage: Query only

14.11.3 SPI (Option R&S RTH-K1)

14.11.3.1 SPI Configuration Settings

BUS:SPI:SCLK:SOURce.....	386
BUS:SPI:SSEL:SOURce.....	386
BUS:SPI:MOSI:SOURce.....	386
BUS:SPI:MISO:SOURce.....	386

BUS:SPI:SCLK:SLOPe.....	386
BUS:SPI:SSEL:POLarity.....	386
BUS:SPI:TECHnology.....	386
BUS:SPI:SCLK:THReshold.....	387
BUS:SPI:SSEL:THReshold.....	387
BUS:SPI:MOSI:THReshold.....	387
BUS:SPI:MISO:THReshold.....	387
BUS:SETRefllevels.....	387
BUS:SPI:WSIZe.....	387
BUS:SPI:ORDer.....	387
BUS:SPI:TIMEout.....	388

BUS:SPI:SCLK:SOURce <Channel>

BUS:SPI:SSEL:SOURce <Channel>

BUS:SPI:MOSI:SOURce <Channel>

BUS:SPI:MISO:SOURce <Channel>

Set the input channels of the SPI lines.

Parameters:

<Channel> C1 | C2 | C3 | C4 | D0 | D1 | D2 | D3 | D4 | D5 | D6 | D7 | NONE

C3 and C4: only R&S RTH1004

Dx: Digital channels are available if option R&S RTH-B1 is installed.

NONE: not available for clock line SCLK.

*RST: C1

BUS:SPI:SCLK:SLOPe <ClockEdge>

Selects if data are sampled on the rising or falling slope of the clock. The clock slope marks the begin of a new bit.

Parameters:

<ClockEdge> POSitive | NEGative

*RST: POSitive

BUS:SPI:SSEL:POLarity <ChipSelectPolarity>

Selects whether the chip select signal is high active (high = 1) or low active (low = 1).

Parameters:

<ChipSelectPolarity> ACTLow | ACTHigh

*RST: ACTHigh

BUS:SPI:TECHnology <ThresholdType>

Sets the threshold values of all SPI lines as defined for various signal technologies.

Parameters:

<ThresholdType> TTL | ECL | CMOS | USER

TTL

1.4 V

ECL

-1.3 V

CMOS

2.5 V

USER

Set a user-defined value for each line using the

`BUS:SPI:<line>:THReshold` commands.

*RST: TTL

Usage:

SCPI confirmed

BUS:SPI:SCLK:THReshold <ThresholdValue>

BUS:SPI:SSEL:THReshold <ThresholdValue>

BUS:SPI:MOSI:THReshold <ThresholdValue>

BUS:SPI:MISO:THReshold <ThresholdValue>

Set a user-defined value for the corresponding line if `BUS:SPI:TECHnology` is set to `USER`.

Parameters:

<ThresholdValue> Range: -400 to 400

Increment: 1E-3

*RST: 1.4

Default unit: V

BUS:SETReflevels

Sets the appropriate threshold or threshold for the selected serial protocol.

Usage: Event

BUS:SPI:WSize <WordLength>

Sets the number of bits in a word.

Parameters:

<WordLength> WL4Bit | WL8Bit | WL12bit | WL16bit | WL20bit | WL24bit |
WL28bit | WL32bit

*RST: WL8Bit

BUS:SPI:ORDer <BitOrder>

Defines if the data of the words starts with MSB (most significant bit) or LSB (least significant bit). Results are displayed in the specified order.

Parameters:

<BitOrder> LSBF | MSBF
 *RST: MSBF

BUS:SPI:TIMEout <FrameTimeout>

Sets the minimum idle time between two data frames. If the time interval between the data frames is shorter, the words are part of the same frame. Within the timeout, the data and clock lines are low. A new frame begins when the timeout has expired.

Timeout is only relevant if the bus has no chip select.

Parameters:

<FrameTimeout> Range: 500E-9 to 1000
 Increment: 1E-3
 *RST: 1E-3
 Default unit: s

14.11.3.2 SPI Trigger

TRIGger:SPI:MODE.....	388
BUS:SPI:SSEL:STATe.....	388
TRIGger:SPI:DSRC.....	389
TRIGger:SPI:DATA.....	389
TRIGger:SPI:DCONDition.....	389
TRIGger:SPI:DPOSition.....	389

TRIGger:SPI:MODE <TriggerType>

Selects the trigger type for SPI analysis.

Parameters:

<TriggerType> FRST | FREN | DATA
 FRST = frame start
 FREN = frame end
 DATA = data.
 For details, see "[SPI Trigger](#)" on page 178.
 *RST: FRST

BUS:SPI:SSEL:STATe <UseChipSelect>

Defines if the SPI bus uses a chip select line or not.

Parameters:

<UseChipSelect> ON | OFF
 *RST: ON

TRIGger:SPI:DSRC <DataSource>

Selects the line, on which the trigger pattern is expected.

Parameters:

<DataSource> MISO | MOSI
 *RST: MISO

TRIGger:SPI:DATA <Pattern>

Specifies the data pattern to be found on the specified line, in binary format. Enter the words in MSB first bit order.

Parameters:

<Pattern> String with max. 32 bit in binary format. Characters 0, 1, and X are allowed.

Example:

```
TRIGger:SPI:DATA '111000'
TRIGger:SPI:DATA?
<--111000
```

Specifies a 6 bit pattern. Higher bits are omitted.

TRIGger:SPI:DCondition <Relation>

Defines how the specified data pattern is compared with the acquired signal. The instrument triggers if the acquired data is equal or unequal to the pattern.

Parameters:

<Relation> EQUal | NEQual
 *RST: EQUal

TRIGger:SPI:DPosition <BitOffset>

Sets the number of bits before the first bit of the pattern. These bits are ignored. The first bit after CS or timeout is bit 0.

Parameters:

<BitOffset> Range: 0 to 4095
 Increment: 1
 *RST: 0

14.11.3.3 SPI Decode Results

The frame suffix <m> selects the frame index for which the result is queried.

The byte suffix <n> selects the byte index for which the result is queried.

BUS:SPI:FCOunt?.....	390
BUS:SPI:FRAMe<m>:DATA?.....	390
BUS:SPI:FRAMe<m>:STATus?.....	390
BUS:SPI:FRAMe<m>:STARt?.....	391

BUS:SPI:FRAME<m>:STOP?.....	391
BUS:SPI:FRAME<m>:WCOunt?.....	391
BUS:SPI:FRAME<m>:WORD<n>:MISO?.....	391
BUS:SPI:FRAME<m>:WORD<n>:MOSI?.....	392
BUS:SPI:FRAME<m>:WORD<n>:START?.....	392
BUS:SPI:FRAME<m>:WORD<n>:STOP?.....	392

BUS:SPI:FCOunt?

Returns the number of decoded frames.

Return values:

<Count> Total number of decoded frames.
 Range: 0 to 100000
 Increment: 1
 *RST: 0

Usage: Query only

BUS:SPI:FRAME<m>:DATA?

Returns the data words of the specified frame.

Suffix:

<m> *
 Selects the frame.

Parameters:

<Data> List of decimal values of data bytes

Example:

```
BUS:SPI:FRAM3:DATA?
<-- 94,177,171,60,242,219,100,0
```

Usage: Query only

BUS:SPI:FRAME<m>:STATus?

Returns the overall status of the specified frame.

Suffix:

<m> *
 Selects the frame.

Return values:

<State> OK | VOID | FRERror | INSufficient
 VOID: The frame is empty.
 FRERror: error in the frame.
 INSufficient: frame is not completely contained in the acquisition. The acquired part of the frame is valid.
 *RST: OK

Usage: Query only

BUS:SPI:FRAME<m>:STARt?

Returns the start time of the specified frame.

Suffix:

<m> *
Selects the frame.

Return values:

<StartTime> Range: -100E+24 to 100E+24
Increment: 100E-12
*RST: 0
Default unit: s

Usage: Query only

BUS:SPI:FRAME<m>:STOP?

Returns the end time of the specified frame.

Suffix:

<m> *
Selects the frame.

Return values:

<StopTime> Range: -100E+24 to 100E+24
Increment: 100E-12
*RST: 0
Default unit: s

Usage: Query only

BUS:SPI:FRAME<m>:WCOunt?

Returns the number of words in the specified frame.

Suffix:

<m> *
Selects the frame.

Return values:

<Count> Number of words

Usage: Query only

BUS:SPI:FRAME<m>:WORD<n>:MISO?

Returns the data value of the specified word on the MISO line.

Suffix:

<m> *
Selects the frame.

<n> *
Selects the word number.

Return values:

<MISOValue> Decimal value of the data word
Range: 0 to 4294967295
Increment: 1
*RST: 0

Usage: Query only

BUS:SPI:FRAME<m>:WORD<n>:MOSI?

Returns the data value of the specified word on the MOSI line.

Suffix:

<m> *
Selects the frame.

<n> *
Selects the word number.

Return values:

<MOSIValue> Decimal value of the data word
Range: 0 to 4294967295
Increment: 1
*RST: 0

Usage: Query only

BUS:SPI:FRAME<m>:WORD<n>:START?

Returns the start time of the specified data word.

Suffix:

<m> *
Selects the frame.

<n> *
Selects the word number.

Return values:

<StartTime> Range: -100E+24 to 100E+24
Increment: 100E-12
*RST: 0
Default unit: s

Usage: Query only

BUS:SPI:FRAME<m>:WORD<n>:STOP?

Returns the end time of the specified data word.

Suffix:
 <m> *
 Selects the frame.
 <n> *
 Selects the word number.

Return values:
 <StopTime> Range: -100E+24 to 100E+24
 Increment: 100E-12
 *RST: 0
 Default unit: s

Usage: Query only

14.11.4 UART/RS-232/RS-422/RS-485 (Option R&S RTH-K2)

- [UART Configuration](#)..... 393
- [UART Trigger](#)..... 396
- [UART Decode Results](#)..... 397

14.11.4.1 UART Configuration

BUS:UART:SOURce	393
BUS:UART:POLarity	394
BUS:UART:TECHnology	394
BUS:UART:THReshold	394
BUS:SETReflevels	394
BUS:UART:STDBitrate	394
BUS:UART:BITRate	395
BUS:UART:SSIZE	395
BUS:UART:PARity	395
BUS:UART:SBIT	395
BUS:UART:ORDer	396
BUS:UART:FRAMemode	396
BUS:UART:TOUT	396

BUS:UART:SOURce <Channel>

Selects the input channel of the UART line.

Parameters:

<Channel> C1 | C2 | C3 | C4 | D0 | D1 | D2 | D3 | D4 | D5 | D6 | D7
 C3 and C4: only R&S RTH1004
 Digital channels are available if option R&S RTH-B1 is installed.
 *RST: C1

BUS:UART:POLarity <Polarity>

Defines the logic states of the line. In idle high state, the idle state corresponds to a logic 1, and the start bit to a logic 0. In idle low state, the idle state corresponds to a logic 0, and the start bit to a logic 1. During idle time, no data is transmitted.

Parameters:

<Polarity> IDLLow | IDLHigh
*RST: IDLHigh

BUS:UART:TECHnology <ThresholdType>

Sets the threshold value of the UART line as defined for various signal technologies.

Parameters:

<ThresholdType> TTL | ECL | CMOS | USER
TTL
1.4 V
ECL
-1.3 V
CMOS
2.5 V
USER
Set a user-defined value using [BUS:UART:THReshold](#).
*RST: TTL

BUS:UART:THReshold <ThresholdValue>

Sets an individual threshold value for digitization of signals if [BUS:UART:TECHnology](#) is set to `USER`.

Parameters:

<ThresholdValue> Range: -400 to 400
Increment: 1E-3
*RST: 1.4
Default unit: V

BUS:SETReflevels

Sets the appropriate threshold or threshold for the selected serial protocol.

Usage: Event

BUS:UART:STDBitrate <Bitrate>

Sets the number of transmitted bits per second.

Parameters:

<Bitrate> BPS_300 | BPS_600 | BPS_1200 | BPS_2400 | BPS_4800 |
 BPS_9600 | BPS_14400 | BPS_19200 | BPS_28800 |
 BPS_38400 | BPS_56000 | BPS_57600 | BPS_115200 |
 BPS_128000 | BPS_230400 | BPS_460800 | BPS_921600 |
 CUSTom

Values in bits per second.

CUSTom: Set the bit rate using [BUS:UART:BITRate](#).

*RST: BPS_14400

BUS:UART:BITRate <CustomBitrate>

Sets a user-defined bit rate if [BUS:UART:STDBitrate](#) is set to CUSTom.

Parameters:

<CustomBitrate> Range: 300 to 20000000
 Increment: 1
 *RST: 14400
 Default unit: bps

BUS:UART:SSIZe <DataBits>

Sets the number of data bits in a word (symbol).

Parameters:

<DataBits> B5 | B6 | B7 | B8 | B9
 *RST: B8

BUS:UART:PARity <Parity>

Defines the optional parity bit that is used for error detection.

Parameters:

<Parity> NONE | ODD | EVEN

NONE
 No parity bit is used.

ODD
 The parity bit is set to "1" if the number of data bits set to "1" is even.

EVEN
 The parity bit is set to "1" if the number of data bits set to "1" is odd.

*RST: NONE

BUS:UART:SBIT <StopBits>

Sets the number of stop bits: 1 or 1.5 or 2 stop bits are possible.

Parameters:

<StopBits> B1 | B15 | B2
 *RST: B1

BUS:UART:ORDER <BitOrder>

Defines if a word starts with MSB (most significant bit) or LSB (least significant bit). The display of the decoded signal considers this setting, results are displayed in the specified order.

Parameters:

<BitOrder> LSBF | MSBF
 *RST: MSBF

BUS:UART:FRAMemode <FrameMode>

IDLE defines frames of several words in the data stream, which are defined by a timeout between a stop bit and the next start bit. Enter the minimum timeout between two frames using [BUS:UART:TOUT](#).

Parameters:

<FrameMode> NONE | IDLE
 *RST: NONE

BUS:UART:TOUT <IdleTime>

Sets the minimum timeout between two frames if [BUS:UART:FRAMemode](#) is set to IDLE.

Parameters:

<IdleTime> Range: 100E-9 to 1
 Increment: 1E-3
 *RST: 1E-3
 Default unit: s

14.11.4.2 UART Trigger

TRIGger:UART:TYPE	396
TRIGger:UART:DATA	397
TRIGger:UART:DCONdition	397

TRIGger:UART:TYPE <TriggerType>

Selects the trigger type for UART analysis.

Parameters:

<TriggerType> STBT | PCKS | DATA | PRER | STPerror | BRKC

STBT = start bit
 PCKS = frame start
 PRER = parity error
 STPerror = stop error
 BRKC = break condition
 DATA: : data. To set up the trigger condition, use [TRIGger:UART:DATA](#), and [TRIGger:UART:DCondition](#).
 For details, see "UART Trigger" on page 184.

*RST: STBT

TRIGger:UART:DATA <Pattern>

Defines the data pattern as trigger condition. Enter the words in MSB first bit order.

Parameters:

<Pattern> String with max. 8 bit in binary format. Characters 0, 1, and X are allowed.

Example:

```
TRIGger:UART:DATA '1x11'
TRIGger:UART:DATA?
1X11
```

TRIGger:UART:DCondition <Relation>

Defines how the specified data pattern is compared with the acquired signal. The instrument triggers if the acquired data is equal or unequal to the pattern.

Parameters:

<Relation> EQUal | NEQual

*RST: EQUal

14.11.4.3 UART Decode Results

The frame suffix <m> selects the frame index for which the result is queried.

The byte suffix <n> selects the byte index for which the result is queried.

BUS:UART:WCOunt?	397
BUS:UART:WORD<m>:STATe?	398
BUS:UART:WORD<m>:START?	398
BUS:UART:WORD<m>:STOP?	398
BUS:UART:WORD<m>:VALue?	399

BUS:UART:WCOunt?

Returns the number of decoded symbols (words).

Return values:

<Count> Total number of decoded words.
 Range: 0 to 100000
 Increment: 1
 *RST: 0

Usage: Query only

BUS:UART:WORD<m>:STATe?

Returns the status of the specified symbol (word).

Suffix:

<m> *
 Selects the word.

Return values:

<State> OK | BREak | STERror | SPERror | PRERror | INSufficient
 OK: the frame is valid.
 BREak: break condition found. A start bit is not followed by a stop bit, and the data line remains at logic 0 for longer than a UART word.
 STERror: start error, no start bit found.
 SPERror: stop error, no stop condition found.
 PRERror: parity error, which indicates a transmission error.
 INSufficient: the frame is not completely contained in the acquisition. The acquired part of the frame is valid.
 *RST: OK

Usage: Query only

BUS:UART:WORD<m>:STARt?

Returns the start time of the specified symbol (word).

Suffix:

<m> *
 Selects the word.

Return values:

<StartTime> Range: -100E+24 to 100E+24
 Increment: 100E-12
 *RST: 0
 Default unit: s

Usage: Query only

BUS:UART:WORD<m>:STOP?

Returns the end time of the specified symbol (word).

Suffix:
 <m> *
 Selects the word.

Return values:
 <StopTime> Range: -100E+24 to 100E+24
 Increment: 100E-12
 *RST: 0
 Default unit: s

Usage: Query only

BUS:UART:WORD<m>:VALue?
 Return the value of the specified symbol (word).

Suffix:
 <m> *
 Selects the word.

Return values:
 <Value> Decimal value
 Range: 0 to 255
 Increment: 1
 *RST: 0

Usage: Query only

14.11.5 CAN (Option R&S RTH-K3)

- [CAN Configuration Settings](#)..... 399
- [CAN Trigger](#)..... 402
- [CAN Decode Results](#)..... 405

14.11.5.1 CAN Configuration Settings

[BUS:CAN:DATA:SOURce](#).....399

[BUS:CAN:TYPE](#)..... 400

[BUS:CAN:BITRate](#)..... 400

[BUS:CAN:TECHnology](#)..... 401

[BUS:CAN:DATA:THReshold](#)..... 401

[BUS:SETReflevels](#)..... 401

[BUS:CAN:SAMPlepoint](#)..... 401

BUS:CAN:DATA:SOURce <Channel>
 Sets the input channel of the CAN line.

Parameters:

<Channel> C1 | C2 | C3 | C4 | D0 | D1 | D2 | D3 | D4 | D5 | D6 | D7
C3 and C4: only R&S RTH1004
Digital channels are available if option R&S RTH-B1 is installed.
*RST: C1

Usage: Asynchronous command

BUS:CAN:TYPE <SignalType>

Selects whether the chip select signal is high active (high = 1) or low active (low = 1).

Parameters:

<SignalType> CANH | CANL
CANH
Signal is high active (high = 1)
CANL
Signal is low active (low = 1)
*RST: CANL

BUS:CAN:BITRate <CustomBitrate>

Sets the number of transmitted bits per second.

Parameters:

<CustomBitrate> Range: 10000 to 1000000
Increment: 1
*RST: 50000
Default unit: bps

BUS:CAN:TECHnology <ThresholdType>**Parameters:**

<ThresholdType> TTL | ECL | CMOS | CAN | GND | LIN7vsupply | LIN12vsupply | LIN18vsupply | USER

TTL

1.4 V

ECL

-1.3 V

CMOS

2.5 V

GND

0 V (for CAN channels, requires option R&S RTH-K3)

CAN

2 V (for CAN channels, requires option R&S RTH-K3)

LIN7vsupply | LIN12vsupply | LIN18vsupply

7 V / 12 V / 18 V (for LIN channels, requires option R&S RTH-K3)

USERSet the value with `CHANnel<m>:THReshold:USER`.

*RST: CAN

BUS:CAN:DATA:THReshold <ThresholdValue>

Sets the threshold value for digitization of signals manually. If the signal value is higher than the threshold, the signal state is high. Otherwise, the signal state is considered low.

This value is only considered for `BUS:CAN:TECHnology USER`

Parameters:

<ThresholdValue> Range: -400 to 400

Increment: 1E-3

*RST: 1.4

Default unit: V

BUS:SETReflevels

Sets the appropriate threshold or threshold for the selected serial protocol.

Usage: Event

BUS:CAN:SAMPlEpoint <SamplePoint>

The sample point divides the nominal bit period into two distinct time segments. The length of the time segments is defined in time quanta according to network and node conditions during CAN development.

Parameters:

<SamplePoint> Range: 10 to 95
 Increment: 1
 *RST: 50
 Default unit: %

14.11.5.2 CAN Trigger

TRIGger:CAN:ACKerror.....402
 TRIGger:CAN:BITSterror..... 402
 TRIGger:CAN:CRCErrror..... 402
 TRIGger:CAN:DATA.....403
 TRIGger:CAN:DCONDition.....403
 TRIGger:CAN:FORMerror.....403
 TRIGger:CAN:FTYPE.....403
 TRIGger:CAN:ICONDition..... 404
 TRIGger:CAN:IDENtifier..... 404
 TRIGger:CAN:ITYPe.....405
 TRIGger:CAN:TYPE.....405

TRIGger:CAN:ACKerror <AckError>

An acknowledgement error occurs when the transmitter does not receive an acknowledgment - a dominant bit during the Ack Slot.

Parameters:

<AckError> ON | OFF
 *RST: ON

TRIGger:CAN:BITSterror <StuffBitError>

A stuff error occurs when the 6th consecutive equal bit level in the mentioned fields is detected.

Parameters:

<StuffBitError> ON | OFF
 *RST: ON

TRIGger:CAN:CRCErrror <CrcError>

A CRC error occurs when the calculated result differs from the received value in the CRC sequence.

Parameters:

<CrcError> ON | OFF
 *RST: ON

TRIGger:CAN:DATA <Pattern>

Specifies the data pattern to be found, in binary or hex format. Enter the pattern in MSB first bit order.

Parameters:

<Pattern> String that contains the pattern in binary format. The parameter accepts the bit value X (don't care).

TRIGger:CAN:DCondition <Relation>

Defines how the specified data pattern is compared with the acquired signal. The instrument triggers if the acquired address is equal or unequal the defined pattern.

Parameters:

<Relation> EQUal | NEQual
*RST: EQUal

TRIGger:CAN:FORMerror <FormError>

A form error occurs when a fixed-form bit field contains one or more illegal bits.

Parameters:

<FormError> ON | OFF
*RST: ON

TRIGger:CAN:FTYPE <FrameType>

CAN has several frame types which can be used as trigger condition.

For data and remote frames, the identifier format has to be set with [TRIGger:CAN:ITYPE](#).

Parameters:

<FrameType> ERRor | OVERload | DATA | REMote | DOR

ERRor

When a node recognizes an error, it cancels transmission by sending an error frame.

The instrument triggers seven bit periods after the end of the error flag that is marked by a dominant-recessive edge.

OVERload

When a node needs a delay between data and/or remote frames, it sends an overload frame.

DATA

The data frame is the only frame for actual data transmission.

REMote

Remote frames are only available in the CAN protocol.

The remote frame initiates the transmission of data by another node. The frame format is the same as of data frames but without the data field.

DOR

Data frames or remote frames initiate the transmission of data by another node. The frame format is the same as of data frames.

*RST: DOR

TRIGger:CAN:ICONdition <Relation>

Defines how the specified identifier pattern is compared with the acquired signal. The instrument triggers if the acquired address is equal or unequal the defined pattern.

Parameters:

<Relation> EQUal | NEQual
*RST: EQUal

TRIGger:CAN:IDENtifier <Pattern>

Specifies the identifier pattern to be found, in binary format. Enter the pattern in MSB first bit order.

Parameters:

<Pattern> String that contains the pattern in binary format. The parameter accepts the bit value X (don't care).

Example:

```
TRIG:CAN:TYPE ID
TRIG:CAN:IDEN 001001
TRIG:CAN:ICON EQU
```

Triggers if the ID of the measured signal is 001001.

TRIGger:CAN:ITYPE <IdentifierType>

Selects the length of the identifier.

Parameters:

<IdentifierType> B11 | B29 | ANY

ANY

The ID type and ID pattern are not relevant for the trigger condition.

If the trigger type is "Identifier", the instrument triggers on any identifier in the specified frame type.

If the trigger type is "Identifier + Data", set the "ID type" to "Any" if you want to trigger only on data.

*RST: ANY

TRIGger:CAN:TYPE <TriggerType>

Depending on the selected CAN trigger type, different additional parameters are available.

Parameters:

<TriggerType> STOF | EOF | FTYP | ID | IDDT | ERRC

STOF

Triggers on the stop bit of the sync field.

EOF

Triggers after a wakeup frame.

FTYP

Triggers on a specified frame type (data, remote, error, or overload). For data and remote frames, also the identifier format is considered.

ID

Sets the trigger to a specific identifier or an identifier range. Only the 6-bit identifier without parity bits is considered, not the protected identifier.

IDDT

Sets the trigger to a combination of identifier and data condition. The instrument triggers at the end of the last byte of the specified data pattern.

ERRC

Identifies various errors in the frame. You can select one or more error types as the trigger condition.

*RST: STOF

14.11.5.3 CAN Decode Results

The frame suffix <m> selects the frame index for which the result is queried.

The byte suffix <n> selects the byte index for which the result is queried.

BUS:CAN:FCOunt?.....	406
BUS:CAN:FRAMe<m>:ACKValue?.....	406
BUS:CAN:FRAMe<m>:BSEPosition?.....	406
BUS:CAN:FRAMe<m>:BYTE<n>:STATe?.....	407
BUS:CAN:FRAMe<m>:BYTE<n>:VALue?.....	407
BUS:CAN:FRAMe<m>:CSValue?.....	407
BUS:CAN:FRAMe<m>:DATA?.....	408
BUS:CAN:FRAMe<m>:DLCValue?.....	408
BUS:CAN:FRAMe<m>:ACKState?.....	408
BUS:CAN:FRAMe<m>:CSState?.....	408
BUS:CAN:FRAMe<m>:DLCState?.....	408
BUS:CAN:FRAMe<m>:IDState?.....	408
BUS:CAN:FRAMe<m>:IDTYpe?.....	409
BUS:CAN:FRAMe<m>:IDValue?.....	409
BUS:CAN:FRAMe<m>:SDATa?.....	409
BUS:CAN:FRAMe<m>:START?.....	409
BUS:CAN:FRAMe<m>:STOP?.....	409
BUS:CAN:FRAMe<m>:STATus?.....	410
BUS:CAN:FRAMe<m>:SYMBol?.....	410
BUS:CAN:FRAMe<m>:TYPE?.....	410

BUS:CAN:FCOunt?

Returns the number of decoded frames in the acquisition.

Return values:

<Count> Range: 0 to 100000
 Increment: 1
 *RST: 0

Usage: Query only

BUS:CAN:FRAMe<m>:ACKValue?

Returns the value of the acknowledge slot for the selected frame.

Suffix:

<m> *

Return values:

<AckValue> Range: 0 to 1
 *RST: 0

Usage: Query only

BUS:CAN:FRAMe<m>:BSEPosition?

Returns the location of a bit stuffing error.

Suffix:

<m> *

Return values:

<BitStuffErrorPos> Range: -100E+24 to 100E+24
 Increment: 100E-12
 *RST: 0
 Default unit: s

Usage: Query only

BUS:CAN:FRAMe<m>:BYTE<n>:STATE?

Returns the state of the specified byte.

Suffix:

<m> *
 <n> *

Return values:

<ByteState> OK | UNDF
 UNDF: Undefined
 *RST: OK

Usage: Query only

BUS:CAN:FRAMe<m>:BYTE<n>:VALue?

Returns the value of the specified byte.

Suffix:

<m> *
 <n> *

Return values:

<ByteValue> Range: 0 to 255
 *RST: 0

Usage: Query only

BUS:CAN:FRAMe<m>:CSValue?

Returns the CRC sequence value of the selected frame.

Suffix:

<m> *

Return values:

<ChecksumValue> Range: 0 to 2097151
 *RST: 0

Usage: Query only

BUS:CAN:FRAME<m>:DATA?

Returns the data of the specified frame.

Suffix:

<m> *

Return values:

<Data> Comma-separated list of integer values. The first value is the number of bytes, followed by the values of the data bytes.

Example:

```
BUS1:CAN:FRAME2:DATA?
--> 3,208,231,32
```

Returns the data of the second frame: the number of bytes is 3 data (first value).

Usage:

Query only

BUS:CAN:FRAME<m>:DLCValue?

Returns the data length code of the selected frame - the number of data bytes in the frame.

Suffix:

<m> *

Return values:

<DataLengthCode> Number of data bytes in decimal values.

Range: 0 to 15

*RST: 0

Usage:

Query only

BUS:CAN:FRAME<m>:ACKState?**BUS:CAN:FRAME<m>:CSState?****BUS:CAN:FRAME<m>:DLCState?****BUS:CAN:FRAME<m>:IDState?**

Return the states of following parts of a message

- ACKState: state of acknowledgement field
- CSState: state of checksum field (CRC)
- DLCState: state of data length code
- IDState: identifier state

Suffix:

<m> *

Return values:

<State> OK | UNDF

UNDF: Undefined

*RST: OK

Usage: Query only

BUS:CAN:FRAME<m>:IDType?

Returns the identifier type of the selected frame, the identifier format of data and remote frames.

Suffix:
<m> *

Return values:
<IdentifierType> ANY | B11 | B29
B11: standard format, 11 bit
B29: extended format, 29 bit
*RST: B11

Usage: Query only

BUS:CAN:FRAME<m>:IDValue?

Returns the identifier value of the selected frame.

Suffix:
<m> *

Return values:
<IdentifierValue> Range: 0 to 536870911
*RST: 0

Usage: Query only

BUS:CAN:FRAME<m>:SDATa?

Returns the complete symbolic data of the selected frame.

Suffix:
<m> *

Return values:
<SymbolicData> String with comma-separated list of symbolic data

Example: `BUS:CAN:FRAME9:SDATa?`
`<-- [sym] 325 kW, 0x0A, 423 N, 174 l, Running, 90 degC, 0x06, 437 rpm`

Returns the symbolic results of the 9th frame.

Usage: Query only

BUS:CAN:FRAME<m>:START?

BUS:CAN:FRAME<m>:STOP?

Returns the start time and stop time of the selected frame.

Suffix:

<m> *

Return values:

<FrameStart> Time
 <FrameStop> Range: -100E+24 to 100E+24
 *RST: 0
 Default unit: s

Usage: Query only**BUS:CAN:FRAMe<m>:STATus?**

Returns the overall state of the selected frame.

Suffix:

<m> *

Return values:

<FrameState> OK | OVLD | ERR | BTST | FORM | CRC | NOACK | CAERror |
 FCERror | INSufficient
 OK: the frame is valid.
 FORM: Fixed-bit form error
 BTST: Bit stuffing error occurred.
 CRC: Cyclic redundancy check failed.
 NOACK: Acknowledge is missing.
 CAERror: CRC error followed by an acknowledgement error
 (missing acknowledge)
 FCERror: CRC error followed by a form error (wrong CRC delimit-
 er or wrong ACK delimiter)
 INSufficient: The frame is not completely contained in the acqui-
 sition. The acquired part of the frame is valid.
 *RST: OK

Usage: Query only**BUS:CAN:FRAMe<m>:SYMBol?**

Returns the symbolic label of the specified frame if the label list is enabled.

Suffix:

<m> *

Return values:

<Label> String with symbolic label of the identifier

Usage: Query only**BUS:CAN:FRAMe<m>:TYPE?**

Returns the frame type of the selected frame.

Suffix:

<m> *

Parameters:

<FrameType> ERRor | OVERload | DATA | REMote | DOR

ERRor

When a node recognizes an error, it cancels transmission by sending an error frame.

The instrument triggers seven bit periods after the end of the error flag that is marked by a dominant-recessive edge.

OVERload

When a node needs a delay between data and/or remote frames, it sends an overload frame.

DATA

The data frame is the only frame for actual data transmission.

REMote

Remote frames are only available in the CAN protocol.

The remote frame initiates the transmission of data by another node. The frame format is the same as of data frames but without the data field.

DOR

Data frames or remote frames initiate the transmission of data by another node. The frame format is the same as of data frames.

*RST: DOR

Usage: Query only

14.11.6 LIN (Option R&S RTH-K3)

- [LIN Configuration Settings](#)..... 411
- [LIN Trigger](#)..... 413
- [LIN Decode Results](#)..... 415

14.11.6.1 LIN Configuration Settings

[BUS:LIN:DATA:SOURce](#)..... 411

[BUS:LIN:POLarity](#)..... 412

[BUS:LIN:BITRate](#)..... 412

[BUS:LIN:STANdard](#)..... 412

[BUS:LIN:DATA:THReshold](#)..... 412

[BUS:LIN:TECHnology](#)..... 413

[BUS:SETReflevels](#)..... 413

BUS:LIN:DATA:SOURce <Channel>

Sets the source of the data line. All channel waveforms can be used.

Parameters:

<Channel> C1 | C2 | C3 | C4 | D0 | D1 | D2 | D3 | D4 | D5 | D6 | D7
 C3 and C4: only R&S RTH1004
 Digital channels are available if option R&S RTH-B1 is installed.
 *RST: C1

Usage:

Asynchronous command

BUS:LIN:POLarity <Polarity>

Defines the idle state of the bus. The idle state is the recessive state and corresponds to a logical 1.

Parameters:

<Polarity> IDLLow | IDLHigh

IDLLow

The bus is idle (state = 1) when the signal is low

IDLHigh

The bus is idle (state = 1) when the signal is high

*RST: IDLHigh

BUS:LIN:BITRate <CustomBitrate>

Sets the number of transmitted bits per second.

Parameters:

<CustomBitrate> Range: 1000 to 20000
 Increment: 1
 *RST: 9600
 Default unit: bps

BUS:LIN:STANdard <Standard>

Selects the version of the LIN standard that is used in the DUT. The setting mainly defines the checksum version used during decoding.

Parameters:

<Standard> V1X | V2X | J2602 | AUTO
 *RST: AUTO

BUS:LIN:DATA:THReshold <ThresholdValue>

Sets the threshold value for digitization of signals manually. If the signal value is higher than the threshold, the signal state is high. Otherwise, the signal state is considered low.

This value is only considered for `BUS:LIN:TECHnology` USER

Parameters:

<ThresholdValue> Range: -400 to 400
 Increment: 1E-3
 *RST: 1.4
 Default unit: V

BUS:LIN:TECHnology <ThresholdType>

Sets the threshold value for digitization of signals according to the specified technology. If the signal value is higher than the threshold, the signal state is high. Otherwise, the signal state is considered low.

To set a user-defined threshold, select **USER** and define the value using **BUS:LIN:DATA:THReshold** on page 412.

Parameters:

<ThresholdType> TTL | ECL | CMOS | CAN | GND | LIN7vsupply | LIN12vsupply | LIN18vsupply | USER

CMOS
2.5 V

LIN7vsupply | LIN12vsupply | LIN18vsupply
7 V / 12 V / 18 V

USER
Set the value with **BUS:LIN:DATA:THReshold**.

*RST: TTL

BUS:SETReflevels

Sets the appropriate threshold or threshold for the selected serial protocol.

Usage: Event

14.11.6.2 LIN Trigger

TRIGger:LIN:CHKSError	413
TRIGger:LIN:DATA	414
TRIGger:LIN:DCONDition	414
TRIGger:LIN:ICONDition	414
TRIGger:LIN:IDENtifier	414
TRIGger:LIN:IPERror	415
TRIGger:LIN:SYERror	415
TRIGger:LIN:TYPE	415

TRIGger:LIN:CHKSError <ChecksumError>

Triggers on a checksum error if **TRIGger:LIN:TYPE** is set to ERRC

Parameters:

<ChecksumError> ON | OFF
 *RST: ON

TRIGger:LIN:DATA <Pattern>

Defines the data pattern as trigger condition. Enter the words in MSB first bit order.

Parameters:

<Pattern> String with max. 4 bytes in binary format. Characters 0, 1, and X are allowed. If you define a pattern with incomplete byte, the missing LSB are filled with X.

Example:

```
TRIG:LIN:TYPE IDDT
TRIG:LIN:IDEN 001001
TRIG:LIN:ICON EQU
TRIG:LIN:DCON EQU
TRIG:LIN:DATA '11111111000000001111'
TRIG:LIN:DATA?
<-- 11111111000000001111XXXX
Triggers when the id '001001' and the data
'11111111000000001111' is detected in the measured signal
```

TRIGger:LIN:DCONDition <Relation>

Defines how the specified data pattern is compared with the acquired signal.

Parameters:

<Relation> EQUal | NEQual
 *RST: EQUal

TRIGger:LIN:ICONDition <Relation>

Defines how the specified identifier pattern is compared with the acquired signal. The instrument triggers if the acquired address is equal or unequal the defined pattern.

Parameters:

<Relation> EQUal | NEQual
 *RST: EQUal

TRIGger:LIN:IDENTifier <Pattern>

Specifies the identifier pattern to be found, in binary format. Enter the pattern in MSB first bit order.

Parameters:

<Pattern> String with max. 7 characters. Characters 0, 1, and X are allowed. If you define a pattern shorter than the pattern length, the missing LSB are filled with X.

Example:

```
TRIG:LIN:TYPE ID
TRIG:LIN:IDEN 001001
TRIG:LIN:ICON EQU
Triggers if the ID of the measured signal is 001001.
```

TRIGger:LIN:IPERror <ParityError>

Triggers on a parity error if `TRIGger:LIN:TYPE` is set to `ERRC`

Parameters:

```
<ParityError>      ON | OFF
*RST:              ON
```

TRIGger:LIN:SYERror <SyncError>

Triggers on a synchronization error if `TRIGger:LIN:TYPE` is set to `ERRC`

Parameters:

```
<SyncError>       ON | OFF
*RST:              ON
```

TRIGger:LIN:TYPE <TriggerType>

Parameters:

```
<TriggerType>    SYNC | WKFR | ERRC | ID | IDDT
```

SYNC
Triggers on the stop bit of the sync field.

WKFR
Triggers after a wakeup frame.

ERRC
Identifies various errors in the frame. You can select one or more error types as the trigger condition.

ID
Sets the trigger to a specific identifier or an identifier range.

IDDT
Sets the trigger to a combination of identifier and data condition. The instrument triggers at the end of the last byte of the specified data pattern.

```
*RST:            SYNC
```

14.11.6.3 LIN Decode Results

The frame suffix `<m>` selects the frame index for which the result is queried.

The byte suffix `<n>` selects the byte index for which the result is queried.

BUS:LIN:FCOunt?.....	416
BUS:LIN:FRAME<m>:BYTE<n>:STATe?.....	416
BUS:LIN:FRAME<m>:BYTE<n>:VALue?.....	416
BUS:LIN:FRAME<m>:CSSTate?.....	417
BUS:LIN:FRAME<m>:CSVAlue?.....	417
BUS:LIN:FRAME<m>:DATA?.....	417
BUS:LIN:FRAME<m>:IDPVAlue?.....	418
BUS:LIN:FRAME<m>:IDSTate?.....	418
BUS:LIN:FRAME<m>:IDVAlue?.....	418
BUS:LIN:FRAME<m>:START?.....	419
BUS:LIN:FRAME<m>:STOP?.....	419
BUS:LIN:FRAME<m>:STATus?.....	419
BUS:LIN:FRAME<m>:SYMBol?.....	419
BUS:LIN:FRAME<m>:SYSTate?.....	420

BUS:LIN:FCOunt?

Returns the number of decoded frames in the acquisition.

Return values:

<Count>	Range:	0 to 100000
	Increment:	1
	*RST:	0

Usage: Query only

BUS:LIN:FRAME<m>:BYTE<n>:STATe?

Returns the state of the specified byte.

Suffix:

<m>	*
<n>	*

Return values:

<ByteState>	OK STERror SPERror UVAL NOEXists INSufficient
	STERror: start error
	SPERror: stop error
	UVAL: unexpected value
	NOEXists: byte does not exist
	INSufficient: the frame is not completely contained in the acquisition. The decoded part of the frame is valid.
	*RST: OK

Usage: Query only

BUS:LIN:FRAME<m>:BYTE<n>:VALue?

Returns the value of the specified byte.

Suffix:

<m> *

<n> *

Return values:

<ByteValue> Range: 0 to 255
 *RST: 0

Usage: Query only**BUS:LIN:FRAME<m>:CSState?**

Returns the checksum state of the specified frame.

Suffix:

<m> *

Return values:

<ChecksumState> OK | STERror | SPERror | UVAL | NOEXists | INSufficient
 STERror: start error
 SPERror: stop error
 UVAL: unexpected value
 NOEXists: byte does not exist
 INSufficient: the frame is not completely contained in the acquisition. The decoded part of the frame is valid.
 *RST: OK

Usage: Query only**BUS:LIN:FRAME<m>:CSValue?**

Returns the checksum value of the specified frame.

Suffix:

<m> *

Return values:

<ChecksumValue> Range: 0 to 255
 *RST: 0

Usage: Query only**BUS:LIN:FRAME<m>:DATA?**

Returns the data bytes of the specified frame.

Suffix:

<m> *

Return values:

<Data> Comma-separated list of integer values (N, D1, D2,..., DN). N is the number of bytes in the frame, and D1...DN are the values of the bytes.

Example:

```
BUS:LIN:FRAME4:DATA?
<-- 4,118,39,71,123
```

Usage:

Query only

BUS:LIN:FRAME<m>:IDPValue?

Returns the value of the identifier parity bits of the selected frame.

Suffix:

<m> *

Return values:

<IdentifierParity> Range: 0 to 3
*RST: 0

Usage:

Query only

BUS:LIN:FRAME<m>:IDState?

Returns the identifier state of the selected frame.

Suffix:

<m> *

Return values:

<IdentifierState> OK | STERror | SPERror | PRERror | UVAL | NOEXists |
INSufficient
STERror: start error
SPERror: stop error
PRERror: parity error
UVAL: unexpected value
NOEXists: byte does not exist
INSufficient: the frame is not completely contained in the acquisition. The decoded part of the frame is valid.
*RST: OK

Usage:

Query only

BUS:LIN:FRAME<m>:IDValue?

Returns the identifier value of the selected frame.

Suffix:

<m> *

Return values:

<IdentifierValue> Range: 0 to 63
 *RST: 0

Usage: Query only

BUS:LIN:FRAME<m>:START?**BUS:LIN:FRAME<m>:STOP?**

Returns the start time and stop time of the selected frame, respectively.

Suffix:

<m> *

Return values:

<FrameStart> Range: -100E+24 to 100E+24
 <FrameStop> Increment: 100E-12
 *RST: 0
 Default unit: s

Usage: Query only

BUS:LIN:FRAME<m>:STATus?

Returns the overall state of the selected frame.

Suffix:

<m> *

Return values:

<FrameState> OK | WAKeup | SYERror | PRERror | CHCKsum | CPERror |
 INSufficient
 CHCKsum: checksum error
 PRERror: parity error in identifier
 SYERror: synchronization error
 WAKeup: the frame is a wakeup frame
 CPERror: parity error and checksum error
 INSufficient: the frame is not completely contained in the acquisition. The decoded part of the frame is valid.
 *RST: OK

Usage: Query only

BUS:LIN:FRAME<m>:SYMBol?

Returns the symbolic label of the specified frame if the label list is enabled.

Suffix:

<m> *

Return values:

<Label> String with symbolic name of the identifier

Example: BUS:LIN:FRAMe2:SYMBol?
Response: Temperature

Usage: Query only

BUS:LIN:FRAMe<m>:SYSTate?

Returns the synchronization state of the frame.

Suffix:
<m> *

Return values:
<FrameSyncState> OK | STERror | SPERror | PRERror | UVAL | NOEXists | INSufficient

OK
The frame is valid.

SPERror
Stop error, no stop condition found

STERror
Start error, no start condition found

PRERror
Parity error, which indicates a transmission error

UVAL
Unexpected value

NOEXists
Byte does not exist

INSufficient
The frame is not completely contained in the acquisition. The acquired part of the frame is valid.

*RST: OK

Usage: Query only

14.12 Logic Analyzer (R&S RTH-B1 MSO)

LOGic:STATe.....	421
LOGic:THCoupling.....	421
LOGic:GROup<m>:TECHnology.....	421
LOGic:GROup<m>:USER.....	422
LOGic:GROup<m>:THReshold?.....	422
LOGic:GROup<m>:HYSTeresis.....	423
LOGic:CHANnel<m>:DESKew.....	423
POD:STATe?.....	424

LOGic:STATe <State>

Enables or disables the logic channels.

Parameters:

<State> ON | OFF
 *RST: OFF

LOGic:THCoupling <ThresCoup>

Couples the threshold and hysteresis settings for the logic channels.

If enabled, all logic channels use the same threshold and hysteresis settings.

If disabled, 2 channel groups are available, which can use different threshold and hysteresis settings: D0 - D3, and D4 - D7.

Parameters:

<ThresCoup> ON | OFF
 *RST: ON

LOGic:GRoup<m>:TECHnology <ThresholdType>

Sets the threshold value for the selected channel group, or for all logic channels.

Suffix:

<m> 1..3
 1 = all logic channels D0 to D7
 2 = group D0 to D3
 3 = group D4 to D7
 The suffix only takes effect if **LOGic:THCoupling** is OFF.

Parameters:

<ThresholdType> TTL | ECL | CMOS | CAN | GND | LIN7vsupply | LIN12vsupply | LIN18vsupply | USER

TTL
1.4 V

ECL
-1.3 V

CMOS
2.5 V

GND
0 V (for CAN channels, requires option R&S RTH-K3)

CAN
2 V (for CAN channels, requires option R&S RTH-K3)

LIN7vsupply | LIN12vsupply | LIN18vsupply
7 V / 12 V / 18 V (for LIN channels, requires option R&S RTH-K3)

12 V Supply
12 V (for LIN channels, requires option R&S RTH-K3)

18 V Supply
18 V (for LIN channels, requires option R&S RTH-K3)

USER
Set the value with `LOGic:GROup<m>:USER`.

*RST: TTL

LOGic:GROup<m>:USER <ThresholdValue>

Sets the threshold value if `LOGic:GROup<m>:TECHnology` is set to USER.

Suffix:

<m> 1..3
1 = all logic channels D0 to D7
2 = group D0 to D3
3 = group D4 to D7
The suffix only takes effect if `LOGic:THCOupling` is OFF.

Parameters:

<ThresholdValue> Range: -400 to 400
Increment: 1E-3
*RST: 1.4
Default unit: V

LOGic:GROup<m>:THReshold?

Returns the current threshold value.

Suffix:

<m> 1..3
 1 = all logic channels D0 to D7
 2 = group D0 to D3
 3= group D4 to D7

Return values:

<Level> Range: -10 to 10
 Increment: 1E-3
 *RST: 0
 Default unit: V

Usage: Query only

LOGic:GROUp<m>:HYSTeresis <Hysteresis>

Hysteresis avoids the change of signal states due to noise oscillation around the threshold level. Set a small hysteresis for clean signals, and large hysteresis for noisy signals.

Suffix:

<m> 1..3
 1 = all logic channels D0 to D7
 2 = group D0 to D3
 3= group D4 to D7
 The suffix only takes effect if `LOGic:THCoupling` is OFF.

Parameters:

<Hysteresis> SMALL | MEDIUM | LARGE
 *RST: MEDIUM

LOGic:CHANnel<m>:DESKew <Value>

Sets the deskew for all channels of a logic probe at once, or for each logic channel separately.

Suffix:

<m> 1..9
 1..8: logic channels 0 to 7
 9: all logic channels

Parameters:

<Value> Range: -100E-9 to 100E-9
 Increment: 800E-12
 *RST: 0
 Default unit: s

Example:

```

LOGic:CHANnel9:DESKew 0.00000001
LOGic:CHANnel8:DESKew 0.00000002
LOGic:CHANnel1:DESKew?
<-- 1e-08
LOGic:CHANnel8:DESKew?
<-- 2e-08

```

POD:STATe?

Returns the connection state of the logic probe.

Return values:

```

<PODConnected>  ON | OFF
                 *RST:  OFF

```

Usage: Query only

14.13 Documenting Results

14.13.1 Export of Waveform Data to File

The commands described in this chapter write the sample data of active waveforms to one or more CSV files.

The resulting files are described in [Chapter 11.4.3, "Waveform Export Files"](#), on page 227.



To export the results of a harmonics measurement, see [Chapter 14.6.3.2, "Retrieving and Exporting Harmonic Results"](#), on page 323.

Example: Saving a single waveform with time values

The example program saves the data of channel 1 to a file on the SD card. Voltage and time values are saved. Then the data is read and deleted.

```

:EXPort:WAVEform:NAME '/media/SD/Waveform.csv'
:EXPort:WAVEform:SOURce C1
:EXPort:WAVEform:INCXvalues 1 // include time values
:EXPort:WAVEform:DLOGging 0 // without history
:EXPort:WAVEform:SAVE ;*OPC
:MMEMory:DATA? '/media/SD/Waveform.csv'
:MMEMory:DELeTe '/media/SD/Waveform.csv';*OPC

```

Example: Saving all active waveforms with time values

The example program saves the voltage and time values of all active analog, digital and math waveforms. Then the data is read and deleted.

```
:EXPort:WAVeform:NAME '/media/SD/Multiwfm.csv'
:EXPort:WAVeform:MULTichannel 1
:EXPort:WAVeform:INCXvalues 1 // include time values
:EXPort:WAVeform:DLOGging 0 // without history
:EXPort:WAVeform:SAVE ;*OPC
:MMEMory:DATA? '/media/SD/Multiwfm.csv'
:MMEMory:DELeTe '/media/SD/Multiwfm.csv';*OPC
```

Example: Saving history data of channel 1, without time values

The example program saves the history data of selected segments to a file on the SD card. Then the data is read and deleted.

```
:EXPort:WAVeform:NAME '/media/SD/WaveformHistory.zip'
:EXPort:WAVeform:SOURce C1
:EXPort:WAVeform:INCXvalues 0 // no time values
:EXPort:WAVeform:DLOGging 1 // include history
:CHANnel1:HISTory:START -77 // select segment range (optional)
:CHANnel1:HISTory:STOP -5
:EXPort:WAVeform:SAVE ;*OPC
:MMEMory:DATA? '/media/SD/WaveformHistory.zip'
:MMEMory:DELeTe '/media/SD/WaveformHistory.zip';*OPC
```

EXPort:WAVeform:NAME.....	425
EXPort:WAVeform:SOURce.....	425
EXPort:WAVeform:MULTichannel.....	426
EXPort:WAVeform:INCXvalues.....	426
EXPort:WAVeform:DLOGging.....	426
EXPort:WAVeform:SAVE.....	427

EXPort:WAVeform:NAME <Name>

Sets the file name, file format and path to save the waveform to.

Parameters:

<Name> String with path and file name with extension .csv or .zip.

Example:

```
EXPort:WAVeform:NAME
'/media/SD/Export/Export_Ch2.csv'
EXPort:WAVeform:SAVE
Saves the waveform data to Export/Export_Ch2.csv on the
SD card.
```

EXPort:WAVeform:SOURce <Source>

Selects the waveform to be exported if `EXPort:WAVeform:MULTichannel` is OFF.

Parameters:

<Source> C1 | C2 | C3 | C4 | M1 | D0 | D1 | D2 | D3 | D4 | D5 | D6 | D7
 D0 | D1 | D2 | D3 | D4 | D5 | D6 | D7: All active logic channels are saved, not matter which Dx is specified in the command.
 *RST: C1

EXPort:WAVeform:MULTichannel <MultiChExport>

If ON, all active waveforms (analog, digital and math) are exported.

If OFF, select the waveform for export with `EXPort:WAVeform:SOURce`.

Parameters:

<MultiChExport> ON | OFF
 ON = 1, and OFF = 0
 *RST: ON

Example: See [Example "Saving all active waveforms with time values"](#) on page 425.

EXPort:WAVeform:INCXvalues <IncHorValues>

Includes horizontal values in the export data (time values).

Parameters:

<IncHorValues> ON | OFF
 ON = 1, and OFF = 0
 *RST: OFF

Example: See [Example "Saving a single waveform with time values"](#) on page 424.

EXPort:WAVeform:DLOGging <DataLogging>

The command requires option R&S RTH-K15. History must be enabled before using the command (`CHAN:HIST:STAT ON`).

The command includes the history data in the export files. If acquisition is running, the command stops the acquisition.

History data is always saved in a zip file (compressed csv), see also [Chapter 3.7.4, "Exporting History Data"](#), on page 96.

You can select a range of history segments with `CHANnel<m>:HISTory:STARt` and `CHANnel<m>:HISTory:STOP`.

Parameters:

<DataLogging> ON | OFF
 ON = 1, and OFF = 0
 *RST: OFF

Example: See [Example "Saving history data of channel 1, without time values"](#) on page 425.

EXPort:WAVeform:SAVE

Saves the waveform(s) to the file specified with `EXPort:WAVeform:NAME`.

Example: See [Example "Saving a single waveform with time values"](#) on page 424.

Usage: Event

14.13.2 Transfer of Waveform Data

Data conversion of integer values if `FORMat:DATA INT,16` is used

To convert INT16 data to physical quantities, e.g. voltages, use the following formulas:

$$\text{PhysicalQuantity} = (\text{Value_ADC} * \text{ConversionFactor}) + \text{VerticalOffset}_{\text{eff}}$$

$$\text{ConversionFactor} = \text{VerticalScale} * \text{VerticalDivisionCount} / \text{NofQuantisationLevels}$$

$$\text{VerticalOffset}_{\text{eff}} = \text{VerticalOffset} - \text{VerticalPosition} * \text{VerticalScale}$$

Table 14-1: Data conversion example

VerticalScale	0.05 V/div
VerticalOffset	0.1 V
VerticalPosition	1 div
NofQuantisationLevels	255 * 256
VerticalDivisionCount	8
Value_ADC	-61
ConversionFactor	$0.05 * 8 / (255 * 256) = 0.000006127451 \text{ V}$
VerticalOffset _{eff}	$0.1 - 1 * 0.05 = 0.05 \text{ V}$
Voltage	$(-61 * 0.000006127451 \text{ V}) + 0.05 \text{ V} = -0.32 \text{ mV}$

The values are read with `CHANnel<m>:DATA[:VALues]?`.

To get the vertical scale, position and offset, you can use the appropriate commands:

- `CHANnel<m>:SCALE` on page 253
- `CHANnel<m>:POSITION` on page 253
- `CHANnel<m>:OFFSET` on page 254

You can find these values also in the data export file, see [Chapter 14.13.1, "Export of Waveform Data to File"](#), on page 424.

FORMat[:DATA] <Format>

Sets the data type that is used for transmission of waveform data from the instrument to the controlling computer.

Waveform data can be retrieved using the following command: [CHANnel<m>:DATA\[:VALues\]?](#) on page 429

Parameters:

<Format>

AScii | INT,16

AScii

Data values are returned in ASCII format as a list of comma separated values in floating point format. The length can be omitted. It is 0 which means that the instrument selects the number of digits to be returned. The query returns both values (ASC, 0).

INT,16

Signed integer data with length 16 bit. It defines that [CHANnel<m>:DATA\[:VALues\]?](#) returns the raw sample data of the ADC as integers. If format of the waveform data differs from the defined export format, the instrument converts the data to the required format.

The schema of the result string is as follows:

```
#41024<value1><value2>...<value n> with:
```

```
#4 = number of digits (= 4 in the example) of the following number
```

```
1024 = number of following data bytes (= 1024 in the example)
```

```
<value> = 4-byte floating point values
```

You can also set the byte order using the [FORMat:BORDER](#) command.

Data conversion is described in "[Data conversion of integer values if FORMat:DATA INT,16 is used](#)" on page 427.

```
*RST:      AScii
```

Example:

```
FORMat:DATA INT,16
```

```
FORMat:DATA?
```

```
<-- INT,16
```

Usage:

SCPI confirmed

FORMat:BORDER <ByteOrder>

Sets the endianness if [FORMat\[:DATA\]](#) is set to INT,16.

Parameters:

<ByteOrder>

MSBFirst | LSBFirst

LSBFirst: little endian, least significant byte first

MSBFirst: big endian, most significant byte first

```
*RST:      LSBFirst
```

CHANnel<m>:DATA:HEADer?

Returns the header of channel waveform data.

Table 14-2: Header data

Position	Meaning	Example
1	XStart in s	-5e-07 = -5 ns
2	XStop in s	5e-07 = 5 ns
3	Record length of the waveform, number of samples	2500
4	Number of values per sample interval. For most waveforms the result is 1, for peak detect and envelope waveforms it is 2. If the number is 2, the number of returned values is twice the record length.	2

Suffix:

<m> 1|2 (RTH1002) , 1..4 (RTH1004)

Example:

```
CHAN1:DATA:HEAD?
-5e-07,5e-07,2500,2
CHANnel1:DATA? returns 5000 values.
```

Usage:

Query only
SCPI confirmed

CHANnel<m>:DATA[:VALues]?

Returns the data of the channel waveform points for transmission from the instrument to the controlling computer. The data can be used in MATLAB, for example.

To set the data format, use [FORMat \[:DATA\]](#) on page 428

Suffix:

<m> 1|2 (RTH1002) , 1..4 (RTH1004)

Return values:

<Data> List of values according to the format

Example:

```
FORM ASC
CHAN2:DATA?
<--
-0.125000,-0.123016,-0.123016,-0.123016,
-0.123016,-0.123016,...
```

Usage:

Query only

14.13.3 Screenshots

The example program creates a screenshot and saves it to a file on the SD card. Then the screenshot data is read and deleted.

```

:HCOPy:LANGUage PNG
:MMEMory:NAME '/media/SD/Screenshot.png'
:HCOPy:IMMEDIATE;*OPC
:MMEMory:DATA? '/media/SD/Screenshot.png'
:MMEMory:DELEte '/media/SD/Screenshot.png';*OPC

```

HCOPy:LANGUage.....	430
HCOPy:COLor.....	430
HCOPy:INVerse.....	430
MMEMory:NAME.....	430
HCOPy:IMMEDIATE.....	430

HCOPy:LANGUage <FileFormat>

Defines the format of the screenshot file.

Parameters:

<FileFormat> PNG | JPG | BMP | TIFF
 *RST: PNG

HCOPy:COLor <BlackWhite>

Creates a black and white screenshot.

Parameters:

<BlackWhite> ON | OFF
 *RST: OFF

HCOPy:INVerse <InverseColor>

Inverts the colors of the output, i.e. a dark waveform is printed on a white background.

Parameters:

<InverseColor> ON | OFF
 *RST: OFF

MMEMory:NAME <Filename>

Defines the filename of the next screenshot.

Parameters:

<Filename> String with the filename

HCOPy:IMMEDIATE

Saves the current display in a new screenshot.

Usage: Event

14.13.4 Instrument Settings, MMEM Commands

The Mass MEMory subsystem provides commands to access the storage media and to save and reload instrument settings.

File and directory names

The <file_name> and <directory_name> parameters are strings. If no complete path is specified, the file location is relative to the current directory, queried with `MMEMory:CDIRectory?`. The file name itself may contain the period as a separator for extensions.

File and directory names can be chosen according to Windows™ conventions. All letters and numbers are allowed, as well as the special characters "_", "^", "\$", "~", "!", "#", "%", "&", "-", "{", "}", "(", ")", "@", and "'". Reserved file names are CON, AUX, COM1, ..., COM4, LPT1, ..., LPT3, NUL and PRN.

<code>MMEMory:SAV</code>	431
<code>MMEMory:RCL</code>	431
<code>MMEMory:DATA</code>	432
<code>MMEMory:CDIRectory</code>	432
<code>MMEMory:MDIRectory</code>	432
<code>MMEMory:RDIRectory</code>	433
<code>MMEMory:DCATalog?</code>	433
<code>MMEMory:DCATalog:LENGth?</code>	434
<code>MMEMory:CATalog?</code>	434
<code>MMEMory:CATalog:LENGth?</code>	435
<code>MMEMory:COPY</code>	435
<code>MMEMory:MOVE</code>	435
<code>MMEMory:DELeTe</code>	436

MMEMory:SAV <FileDestination>

Stores the current instrument settings to the specified file.

Parameters:

<FileDestination> String parameter specifying path and filename of the target file. Wildcards are not allowed.

Example:

```
MMEM:SAV
"/media/SD/Rohde-Schwarz/RTH/SaveSets/SetupMeasA.dfl"
Saves the current instrument settings to the file
SetupMeasA.dfl located in the directory /media/SD/
Rohde-Schwarz/RTH/SaveSets/ on the microSD card.
```

Usage: Event

MMEMory:RCL <FileDestination>

Restores the instrument settings from the specified file.

Parameters:

<FileDestination> String parameter specifying path and filename of the settings file. Wildcards are not allowed.

Example:

```
MMEM:RCL
"/media/SD/Rohde-Schwarz/RTH/SaveSets/SetupMeasA.dfl"
Loads and activates the instrument settings from the file
SetupMeasA.dfl located in the directory /media/SD/
Rohde-Schwarz/RTH/SaveSets/ on the microSD card.
```

Usage:

Event

MMEMory:DATA <FileName>,<Data>

Writes data to the specified file in the current directory `MMEMory:CDIRectory`, or reads the data.

Parameters:

<Data> 488.2 block data
The block begins with character '#'. The next digit is the length of the length information. Then the length information digits provide the number of bytes in the binary data.

Parameters for setting and query:

<FileName> String parameter containing the file name

Example:

```
MMEM:DATA "abc.txt", #216This is the file
#2: the length information has two digits
16: the binary data has 16 bytes.
MMEM:DATA? "abc.txt"
received: This is the file
```

MMEMory:CDIRectory <DirectoryName>

Specifies the current directory for file access.

Setting parameters:

<DirectoryName> String parameter to specify the directory.

Example:

```
MMEM:CDIR "/media/USB1/Data";*OPC
```

MMEMory:MDIRectory <DirectoryName>

Creates a new directory with the specified name.

Setting parameters:

<DirectoryName> String parameter
Absolute path, or path relative to the current directory.

Example:

```
Create directory Data on the USB flash device using absolute
path:
MMEM:MDIR "/media/USB1/Data"
```

Usage: Setting only

MMEMory:RDIRectory <DirectoryName>

Deletes the specified directory.

Note: All subdirectories and all files in the specified directory and in the subdirectories are deleted!

You cannot delete the current directory or a superior directory. In this case, the instrument returns an execution error.

Setting parameters:

<DirectoryName> String parameter, absolute path or relative to the current directory

Example: MMEM:RDIR "/media/USB1/Screenshots"
Deletes the directory `Screenshots` on the USB flash drive.

Usage: Setting only

MMEMory:DCATalog? <DirectoryName>

Returns the subdirectories of the specified directory. The result corresponds to the number of strings returned by the `MMEMory:DCATalog:LENgth?` command.

Query parameters:

<DirectoryName> String parameter
Specifies the directory.

Return values:

<FileEntry> String parameter
List of subdirectory strings separated by commas. The current and the parent directories are also returned ("`.,,0`", "`.,.,,0`").

Example: Query for directories using absolute path:
MMEM:DCAT? "/media/USB1/*"
received "`.,,0`", "`.,.,,0`", "`Export,,0`", "`SaveSets,,0`", "`SCREENSHOTS,,0`"
MMEM:DCAT:LENG? "/media/USB1/*"
received 5

Example: Query for directories in the current directory:
MMEM:CDIR "/media/USB1/"
MMEM:DCAT? "*" "
received "`.,,0`", "`.,.,,0`", "`JANUARY,,0`", "`FEBRUARY,,0`"
MMEM:DCAT:LENG? "*" "
received 4

Example: Query for directories starting with S using filter:

```
MMEM:DCAT? "/media/USB1/S*"
received "SaveSets,,0","Slots,,0"
MMEM:DCAT:LENG? "/media/USB1/S*"
received 2
```

Usage: Query only

MMEMory:DCATalog:LENGth? <DirectoryName>

Returns the number of directories in specified directory. The result corresponds to the number of strings returned by the `MMEMory:DCATalog?` command.

Query parameters:

<DirectoryName> String parameter
Specifies the directory.

Return values:

<FileEntryCount> Number of directories.

Example:

```
MMEMory:DCATalog:LENGth
"/media/SD/Rohde-Schwarz/RTH"
recieved: 12
```

Usage: Query only

MMEMory:CATalog? <DirectoryName>[,<Format>]

Returns the a list of files contained in the specified directory. The result corresponds to the number of files returned by the `MMEMory:CATalog:LENGth?` command.

The list of return values has the following order:

<UsedMemory>,<FreeMemory>,<FileEntry1>,<FileEntry2>,...

Query parameters:

<DirectoryName> String parameter
Specifies the directory. A filter can be used to list, for example, only files of a given file type.

<Format> ALL | WTIME
ALL: Extended result including file, date, time and attributes
WTIME: Result including file, date, time

Return values:

<UsedMemory> Total amount of storage currently used in the directory, in bytes.

<FreeMemory> Total amount of storage available in the directory, in bytes.

<FileEntry> String parameter
All files of the directory are listed with their file name, format and size in bytes.

- Example:** Query for files in the SaveSets directory on the USB flash drive using absolute path:
 MMEM:CAT? "/media/USB1/SaveSets/*.*"

received: 511104,8633856,"Settings_Mon.xml,,8",

"Settings_Tue.xml,,8"
- Example:** Query for files that start with Settings in a user-defined directory on the USB flash drive:
 MMEM:CAT? "/media/USB1/Misc/Settings*.*"

received: 511104,8633856,"Settings_160321.xml,,

8","Settings_160322.xml,,8"
- Usage:** Query only

MMEMory:CATalog:LENGth? <DirectoryName>

Returns the number of files in the specified directory. The result corresponds to the number of files returned by the `MMEMory:CATalog?` command.

Query parameters:

<PathName> String parameter
 Directory to be queried, absolute or relative path

Return values:

<Count> Number of files.

Usage: Query only

MMEMory:COPI <FileSource>,<FileDestination>

Copies data to another directory on the same or different storage device. The file name can be changed, too.

Setting parameters:

<FileSource> String parameter
 Name and path of the file to be copied

<FileDestination> String parameter
 Name and path of the new file. If the file already exists, it is overwritten without notice.

Example: MMEM:COPY "/media/SD/Rohde-Schwarz/RTH/SaveSets/Settings1.xml",

"/media/USB1/SaveSets/Settings1.xml"

Usage: Setting only

MMEMory:MOVE <FileSource>, <FileDestination>

Moves an existing file to a new location.

Setting parameters:

<FileSource> String parameter
 Path and name of the file to be moved.

<FileDestination> String parameter
 Path and name of the new file.

Example: `MMEM:MOVE "/media/SD/Rohde-Schwarz/RTH/SaveSets/Settings1.xml",
 "/media/USB1/SaveSets/Settings1.xml"`

Usage: Setting only

MMEMory:DELeTe <FileSource>

Removes a file from the specified directory.

Setting parameters:

<FileSource> String parameter
 File name and path of the file to be removed. If the path is omitted, the specified file is deleted in the current directory. Filters are not allowed.

Example: `MMEM:DELeTe "/media/USB1/SaveSets/Settings1.xml"`

Usage: Setting only

14.14 General Instrument Setup

- [Date and Time](#).....436
- [Display Settings](#)..... 437

14.14.1 Date and Time

SYSTem:DATE [<Year>], [<Month>], [<Day>]

SYSTem:DATE? [<Year>], [<Month>]

Sets the date on the instrument.

Parameters:

<Day> Range: 1 to 31
 Increment: 1
 *RST: 1

Parameters for setting and query:

<Year> Range: 2012 to 2099
 Increment: 1
 *RST: 2012

<Month> Range: 1 to 12
 Increment: 1
 *RST: 1

SYSTem:TIME [<Hours>], [<Minutes>], [<Seconds>]

SYSTem:TIME? [<Hours>], [<Minutes>]

Sets the time on the instrument.

Parameters:

<Seconds> Range: 0 to 59
 Increment: 1
 *RST: 1

Parameters for setting and query:

<Hours> Range: 0 to 24
 Increment: 1
 *RST: 1

<Minutes> Range: 0 to 59
 Increment: 1
 *RST: 1

14.14.2 Display Settings

DISPlay:PERsistence[:TYPE]	437
DISPlay:PERsistence:TIME	438
DISPlay:CONTRast	438
DISPlay:MOUS	438
DISPlay:LCD	438

DISPlay:PERsistence[:TYPE] <PersistenceType>

Defines how long every new data point remains on the screen.

Parameters:

<PersistenceType> OFF | TIME | INF

OFF

Deactivates persistence.

TIME

Data points remain on the screen for the duration defined with [DISPlay:PERsistence:TIME](#).

INF

Data points remain on the screen infinitely until persistence is set to OFF.

*RST: OFF

DISPlay:PERSistence:TIME <PersistenceTime>

Sets a user-defined persistence time. The command takes effect if **DISPlay:PERSistence[:TYPE]** is set to **TIME**.

Parameters:

<PersistenceTime> Range: 0.05 to 10
 Increment: 0.01
 *RST: 0.05
 Default unit: s

DISPlay:CONTRast <ContrastMode>

If enabled, the waveforms are displayed in black color on white background.

Parameters:

<ContrastMode> ON | OFF
 *RST: OFF

DISPlay:MOUS <EnableTouch>

Switches the touch functionality of the screen on or off.

If you use the instrument in an environment with immissions considerably higher than specified, the immissions may affect the touch sensitivity of the screen. In this case, disable the touch and operate the instrument using the keys and the wheel.

Parameters:

<EnableTouch> ON | OFF
 *RST: OFF

DISPlay:LCD <EnableLCD>

Turns the LCD display on or off.

Parameters:

<EnableLCD> ON | OFF
 *RST: OFF

14.15 WLAN Connection (Option R&S RTH-K200/200US)

SYSTem:COMMunicate:WLAN:MODE <Mode>

Selects the wireless LAN function of the instrument. It can serve as access point or as client.

Parameters:

<Mode>

ACCesspoint | CLient

*RST: ACCesspoint

Annex

A SCPI Command Structure

SCPI commands consist of a header and, in most cases, one or more parameters. The header and the parameters are separated by a "white space" (ASCII code 0 to 9, 11 to 32 decimal, e.g. blank). The headers may consist of several mnemonics (keywords). Queries are formed by appending a question mark directly to the header.

The commands can be either device-specific or device-independent (common commands). Common and device-specific commands differ in their syntax.

A.1 Syntax for Common Commands

Common (= device-independent) commands consist of a header preceded by an asterisk (*), and possibly one or more parameters.

Table A-1: Examples of common commands

*RST	RESET	Resets the instrument.
*ESE	EVENT STATUS ENABLE	Sets the bits of the event status enable registers.
*ESR?	EVENT STATUS QUERY	Queries the contents of the event status register.
*IDN?	IDENTIFICATION QUERY	Queries the instrument identification string.

A.2 Syntax for Device-Specific Commands



Not all commands used in the following examples are necessarily implemented in the instrument. For demonstration purposes only, assume the existence of the following commands for this section:

- DISPLAY[:WINDOW<1...4>]:MAXimize <Boolean>
- FORMAT:READings:DATA <type>[,<length>]
- HCOpy:DEvice:COLor <Boolean>
- HCOpy:DEvice:CMAP:COLor:RGB <red>,<green>,<blue>
- HCOpy[:IMMediate]
- HCOpy:ITEM:ALL
- HCOpy:ITEM:LABel <string>
- HCOpy:PAGE:DIMensions:QUADrant[<N>]
- HCOpy:PAGE:ORientation LANDscape | PORTrait
- HCOpy:PAGE:SCALE <numeric value>
- MMEMory:COpy <file_source>,<file_destination>
- SENSE:BANDwidth|BWIDth[:RESolution] <numeric_value>
- SENSE:FREQuency:STOP <numeric value>
- SENSE:LIST:FREQuency <numeric_value>{,<numeric_value>}

- [Long and short form](#)..... 441
- [Numeric Suffixes](#)..... 442
- [Optional Mnemonics](#)..... 442

A.2.1 Long and short form

The mnemonics feature a long form and a short form. The short form is marked by upper case letters, the long form corresponds to the complete word. Either the short form or the long form can be entered; other abbreviations are not permitted.

Example:

HCOpy:DEvice:COLor ON is equivalent to HCOP:DEV:COL ON.



Case-insensitivity

Upper case and lower case notation only serves to distinguish the two forms in the manual, the instrument itself is case-insensitive.

A.2.2 Numeric Suffixes

If a command can be applied to multiple instances of an object, e.g. specific channels or sources, the required instances can be specified by a suffix added to the command. Numeric suffixes are indicated by angular brackets (<1...4>, <n>, <i>) and are replaced by a single value in the command. Entries without a suffix are interpreted as having the suffix 1.

Example:

Definition: `HCOPY:PAGE:DIMensions:QUADrant [<N>]`

Command: `HCOP:PAGE:DIM:QUAD2`

This command refers to the quadrant 2.



Different numbering in remote control

For remote control, the suffix may differ from the number of the corresponding selection used in manual operation. SCPI prescribes that suffix counting starts with 1. Suffix 1 is the default state and used when no specific suffix is specified.

Some standards define a fixed numbering, starting with 0. If the numbering differs in manual operation and remote control, it is indicated for the corresponding command.

A.2.3 Optional Mnemonics

Some command systems permit certain mnemonics to be inserted into the header or omitted. These mnemonics are marked by square brackets in the description. The instrument must recognize the long command to comply with the SCPI standard. Some commands are considerably shortened by these optional mnemonics.

Example:

Definition: `HCOPY[:IMMEDIATE]`

Command: `HCOP:IMM` is equivalent to `HCOP`



Optional mnemonics with numeric suffixes

Do not omit an optional mnemonic if it includes a numeric suffix that is relevant for the effect of the command.

Example:

Definition: `DISPlay[:WINDow<1...4>]:MAXimize <Boolean>`

Command: `DISP:MAX ON` refers to window 1.

In order to refer to a window other than 1, you must include the optional `WINDow` parameter with the suffix for the required window.

`DISP:WIND2:MAX ON` refers to window 2.

A.3 SCPI Parameters

Many commands are supplemented by a parameter or a list of parameters. The parameters must be separated from the header by a "white space" (ASCII code 0 to 9, 11 to 32 decimal, e.g. blank).

The parameters required for each command and the allowed range of values are specified in the command description.

Allowed parameters are:

• Numeric Values	443
• Special Numeric Values	444
• Boolean Parameters	444
• Text Parameters	445
• Character Strings	445
• Block Data	445

A.3.1 Numeric Values

Numeric values can be entered in any form, i.e. with sign, decimal point and exponent. Values exceeding the resolution of the instrument are rounded up or down. The mantissa may comprise up to 255 characters, the exponent must lie inside the value range -32000 to 32000. The exponent is introduced by an "E" or "e". Entry of the exponent alone is not allowed.

Example:

```
SENS:FREQ:STOP 1500000 = SENS:FREQ:STOP 1.5E6
```

Units

For physical quantities, the unit can be entered. If the unit is missing, the basic unit is used. Allowed unit prefixes are:

- G (giga)
- MA (mega), MOHM, MHZ
- K (kilo)
- M (milli)
- U (micro)
- N (nano)

Example:

```
SENSe:FREQ:STOP 1.5GHz = SENSe:FREQ:STOP 1.5E9
```

Some settings allow relative values to be stated in percent. According to SCPI, this unit is represented by the PCT string.

Example:

```
HCOP:PAGE:SCAL 90PCT
```

A.3.2 Special Numeric Values

The following mnemonics are special numeric values. In the response to a query, the numeric value is provided.

- **MIN and MAX:** denote the minimum and maximum value.
- **DEF:** denotes a preset value which has been stored in the EPROM. This value conforms to the default setting, as it is called by the *RST command.
- **UP and DOWN:** increases or reduces the numeric value by one step. The step width can be specified via an allocated step command for each parameter which can be set via UP and DOWN.
- **INF and NINF:** INFinity and negative INFinity (NINF) represent the numeric values 9.9E37 or -9.9E37, respectively. INF and NINF are only sent as instrument responses.
- **NAN:** Not A Number (NAN) represents the value 9.91E37. NAN is only sent as a instrument response. This value is not defined. Possible causes are the division of zero by zero, the subtraction of infinite from infinite and the representation of missing values.

Example:

Setting command: `SENSe:LIST:FREQ MAXimum`

Query: `SENS:LIST:FREQ?`

Response: `3.5E9`



Queries for special numeric values

The numeric values associated to `MAXimum`/`MINimum`/`DEFault` can be queried by adding the corresponding mnemonic after the quotation mark.

Example: `SENSe:LIST:FREQ? MAXimum`

Returns the maximum numeric value as a result.

A.3.3 Boolean Parameters

Boolean parameters represent two states. The "ON" state (logically true) is represented by "ON" or a numeric value 1. The "OFF" state (logically untrue) is represented by "OFF" or the numeric value 0. The numeric values are provided as the response for a query.

Example:

Setting command: `HCOPY:DEV:COL ON`

Query: `HCOPY:DEV:COL?`

Response: 1

A.3.4 Text Parameters

Text parameters observe the syntactic rules for mnemonics, i.e. they can be entered using a short or long form. Like any parameter, they have to be separated from the header by a white space. In the response to a query, the short form of the text is provided.

Example:

Setting command: `HCOPY:PAGE:ORIENTATION LANDscape`

Query: `HCOPY:PAGE:ORI?`

Response: LAND

A.3.5 Character Strings

Strings must always be entered in quotation marks (' or ").

Example:

`HCOPY:ITEM:LABEL "Test1"`

`HCOPY:ITEM:LABEL 'Test1'`

A.3.6 Block Data

Block data is a format which is suitable for the transmission of large amounts of data. For example, a command using a block data parameter has the following structure:

```
FORMat:READings:DATA #45168xxxxxxxx
```

The ASCII character # introduces the data block. The next number indicates how many of the following digits describe the length of the data block. In the example the 4 following digits indicate the length to be 5168 bytes. The data bytes follow. During the transmission of these data bytes all end or other control signs are ignored until all bytes are transmitted.

#0 specifies a data block of indefinite length. The use of the indefinite format requires a `NL^END` message to terminate the data block. This format is useful when the length of the transmission is not known or if speed or other considerations prevent segmentation of the data into blocks of definite length.

A.4 Overview of Syntax Elements

The following tables provide an overview of the syntax elements and special characters.

Table A-2: Syntax elements

:	The colon separates the mnemonics of a command.
;	The semicolon separates two commands of a command line. It does not alter the path.
,	The comma separates several parameters of a command.
?	The question mark forms a query.
*	The asterisk marks a common command.
' '	Quotation marks introduce a string and terminate it (both single and double quotation marks are possible).
#	The hash symbol introduces binary, octal, hexadecimal and block data. <ul style="list-style-type: none">• Binary: #B10110• Octal: #O7612• Hexa: #HF3A7• Block: #21312
	A "white space" (ASCII-Code 0 to 9, 11 to 32 decimal, e.g. blank) separates the header from the parameters.

Table A-3: Special characters

	<p>Parameters</p> <p>A vertical stroke in parameter definitions indicates alternative possibilities in the sense of "or". The effect of the command differs, depending on which parameter is used.</p> <p>Example:</p> <p>Definition:HCOPY:PAGE:ORIENTATION LANDscape PORtrait</p> <p>Command HCOP:PAGE:ORI LAND specifies landscape orientation</p> <p>Command HCOP:PAGE:ORI PORT specifies portrait orientation</p> <p>Mnemonics</p> <p>A selection of mnemonics with an identical effect exists for several commands. These mnemonics are indicated in the same line; they are separated by a vertical stroke. Only one of these mnemonics needs to be included in the header of the command. The effect of the command is independent of which of the mnemonics is used.</p> <p>Example:</p> <p>DefinitionSENSE:BANDwidth BWIDth[:RESolution] <numeric_value></p> <p>The two following commands with identical meaning can be created:</p> <p>SENS:BAND:RES 1</p> <p>SENS:BWID:RES 1</p>
[]	<p>Mnemonics in square brackets are optional and may be inserted into the header or omitted.</p> <p>Example: HCOpy[:IMMEDIATE]</p> <p>HCOP: IMM is equivalent to HCOP</p>
{ }	<p>Parameters in curly brackets are optional and can be inserted once or several times, or omitted.</p> <p>Example: SENSE:LIST:FREQuency <numeric_value>{,<numeric_value>}</p> <p>The following are valid commands:</p> <p>SENS:LIST:FREQ 10</p> <p>SENS:LIST:FREQ 10,20</p> <p>SENS:LIST:FREQ 10,20,30,40</p>

A.5 Structure of a Command Line

A command line may consist of one or several commands. It is terminated by one of the following:

- <New Line>
- <New Line> with EOI
- EOI together with the last data byte

Several commands in a command line must be separated by a semicolon ";".

Example:

```
MMEM:COPY "Test1","MeasurementXY";:HCOP:ITEM ALL
```

This command line contains two commands. The first command belongs to the MMEM system, the second command belongs to the HCOP system. If the next command belongs to a different command system, the semicolon is followed by a colon.

Example:

```
HCOP:ITEM ALL;:HCOP:IMM
```

This command line contains two commands. Both commands are part of the `HCOP` command system, i.e. they have one level in common.

If the successive commands belong to the same system, having one or several levels in common, the command line can be abbreviated. When abbreviating the command line, the second command begins with the level below `HCOP`. The colon after the semicolon is omitted. The abbreviated form of the command line reads as follows:

```
HCOP:ITEM ALL;IMM
```

Example:

```
HCOP:ITEM ALL
```

```
HCOP:IMM
```

A new command line always begins with the complete path.

A.6 Responses to Queries

A query is defined for each setting command unless explicitly specified otherwise. It is formed by adding a question mark to the associated setting command. According to SCPI, the responses to queries are partly subject to stricter rules than in standard IEEE 488.2.

- The requested parameter is transmitted without a header.
Example: `HCOP:PAGE:ORI?`, **Response:** `LAND`
- Maximum values, minimum values and all other quantities that are requested via a special text parameter are returned as numeric values.
Example: `SENSe:FREQuency:STOP? MAX`, **Response:** `3.5E9`
- Numeric values are output without a unit. Physical quantities are referred to the basic units or to the units set using the `Unit` command. The response `3.5E9` in the previous example stands for 3.5 GHz.
- Truth values (Boolean values) are returned as 0 (for OFF) and 1 (for ON).
Example:
Setting command: `HCOPy:DEV:COL ON`
Query: `HCOPy:DEV:COL?`
Response: `1`
- Text (character data) is returned in a short form.
Example:
Setting command: `HCOPy:PAGE:ORIENTATION LANDscape`
Query: `HCOP:PAGE:ORI?`
Response: `LAND`
- Invalid numerical results
In some cases, particularly when a result consists of multiple numeric values, invalid values are returned as `9.91E37` (not a number).

B Command Sequence and Synchronization

IEEE 488.2 defines a distinction between overlapped (asynchronous) and sequential commands:

- A sequential command finishes executing before the next command starts executing. Commands that are processed quickly are usually implemented as sequential commands.
- An overlapping or asynchronous command does not automatically finish executing before the next command starts executing. Usually, overlapping commands take longer to process and allow the program to do other tasks while being executed. If overlapping commands must be executed in a defined order, e.g. to avoid wrong measurement results, they must be serviced sequentially. This method is called synchronization between the controller and the instrument.



As a rule, send commands and queries in different program messages, i.e. in separate command lines.

Do not combine queries with commands that affect the queried value in one program message because the response to the query is not predictable.

The following messages always return correct results:

```
:CHAN:SCAL 0.01;POS 1
```

```
:CHAN:SCAL?
```

```
Result: 0.01 (10 mV/div)
```

Reason: Setting commands within one command line, even though they are implemented as sequential commands, are not necessarily serviced in the order in which they have been received.

For further information, refer to:

- rohde-schwarz.com/rckb: Rohde & Schwarz web page that provides information on instrument drivers and remote control.
- "Automatic Measurement Control - A tutorial on SCPI and IEEE 488.2" from John M. Pieper (R&S order number 0002.3536.00). The book offers detailed information on concepts and definitions of SCPI.

B.1 Preventing Overlapping Execution

To prevent an overlapping execution of commands, one of the commands `*OPC`, `*OPC?` or `*WAI` can be used. All three commands cause a certain action only to be carried out after the hardware has been set. The controller can be forced to wait for the corresponding action to occur.

Table B-1: Synchronization using *OPC, *OPC? and *WAI

Com- mand	Action	Programming the controller
*OPC	Sets the Operation Complete bit in the ESR after all previous commands have been executed.	<ul style="list-style-type: none"> Setting bit 0 in the ESE Setting bit 5 in the SRE Waiting for service request (SRQ)
*OPC?	Stops command processing until 1 is returned. This occurs when all pending operations are completed.	Send *OPC? directly after the command whose processing must be terminated before other commands can be executed.
*WAI	Stops further command processing until all commands sent before *WAI have been executed.	Send *WAI directly after the command whose processing must be terminated before other commands are executed.

Command synchronization using *WAI or *OPC? is a good choice if the overlapped command takes only little time to process. The two synchronization commands simply block overlapped execution of the command. Append the synchronization command to the overlapping command, for example:

```
SINGLE; *OPC?
```

For time consuming overlapped commands, you can allow the controller or the instrument to do other useful work while waiting for command execution. Use one of the following methods:

***OPC with a service request**

1. Set the OPC mask bit (bit no. 0) in the ESE: *ESE 1
2. Set bit no. 5 in the SRE: *SRE 32 to enable ESB service request.
3. Send the overlapped command with *OPC .
4. Wait for a service request.

The service request indicates that the overlapped command has finished.

***OPC? with a service request**

1. Set bit no. 4 in the SRE: *SRE 16 to enable MAV service request.
2. Send the overlapped command with *OPC?.
3. Wait for a service request.

The service request indicates that the overlapped command has finished.

Event status register (ESE)

1. Set the OPC mask bit (bit no. 0) in the ESE: *ESE 1
2. Send the overlapped command without *OPC, *OPC? or *WAI.
3. Poll the operation complete state periodically (with a timer) using the sequence:
*OPC; *ESR?

A return value (LSB) of 1 indicates that the overlapped command has finished.

List of Commands

ACQUIRE:ARESet:IMMediate.....	259
ACQUIRE:AVAILable?.....	298
ACQUIRE:AVERAge:COUNT.....	259
ACQUIRE:MODE.....	259
ACQUIRE:POINts:ARATe?.....	258
ACQUIRE:POINts[:VALue]?.....	260
ACQUIRE:RESolution?.....	260
AUToscale.....	252
BUS:CAN:BITRate.....	400
BUS:CAN:DATA:SOURce.....	399
BUS:CAN:DATA:THReshold.....	401
BUS:CAN:FCOunt?.....	406
BUS:CAN:FRAME<m>:ACKState?.....	408
BUS:CAN:FRAME<m>:ACKValue?.....	406
BUS:CAN:FRAME<m>:BSEPosition?.....	406
BUS:CAN:FRAME<m>:BYTE<n>:STATe?.....	407
BUS:CAN:FRAME<m>:BYTE<n>:VALue?.....	407
BUS:CAN:FRAME<m>:CSSTate?.....	408
BUS:CAN:FRAME<m>:CSValue?.....	407
BUS:CAN:FRAME<m>:DATA?.....	408
BUS:CAN:FRAME<m>:DLCState?.....	408
BUS:CAN:FRAME<m>:DLCValue?.....	408
BUS:CAN:FRAME<m>:IDSTate?.....	408
BUS:CAN:FRAME<m>:IDTYpe?.....	409
BUS:CAN:FRAME<m>:IDValue?.....	409
BUS:CAN:FRAME<m>:SDATa?.....	409
BUS:CAN:FRAME<m>:START?.....	409
BUS:CAN:FRAME<m>:STATus?.....	410
BUS:CAN:FRAME<m>:STOP?.....	409
BUS:CAN:FRAME<m>:SYMBol?.....	410
BUS:CAN:FRAME<m>:TYPE?.....	410
BUS:CAN:SAMPlepoint.....	401
BUS:CAN:TECHnology.....	401
BUS:CAN:TYPE.....	400
BUS:FORMat.....	375
BUS:I2C:FCOunt?.....	379
BUS:I2C:FRAME<m>:AACcess?.....	380
BUS:I2C:FRAME<m>:ACcess?.....	380
BUS:I2C:FRAME<m>:ACOMplete?.....	380
BUS:I2C:FRAME<m>:ADBStart?.....	380
BUS:I2C:FRAME<m>:ADDRess?.....	381
BUS:I2C:FRAME<m>:ADEvice?.....	381
BUS:I2C:FRAME<m>:AMODE?.....	381
BUS:I2C:FRAME<m>:ASTart?.....	381
BUS:I2C:FRAME<m>:BCOunt?.....	382
BUS:I2C:FRAME<m>:BYTE<n>:ACcess?.....	382
BUS:I2C:FRAME<m>:BYTE<n>:ACKStart?.....	382

BUS:I2C:FRAMe<m>:BYTE<n>:COMPLete?	382
BUS:I2C:FRAMe<m>:BYTE<n>:START?	383
BUS:I2C:FRAMe<m>:BYTE<n>:VALue?	383
BUS:I2C:FRAMe<m>:DATA?	383
BUS:I2C:FRAMe<m>:RWBStart?	383
BUS:I2C:FRAMe<m>:START?	384
BUS:I2C:FRAMe<m>:STATus?	384
BUS:I2C:FRAMe<m>:STOP?	385
BUS:I2C:SCL:SOURce	375
BUS:I2C:SCL:THReshold	376
BUS:I2C:SDA:SOURce	375
BUS:I2C:SDA:THReshold	376
BUS:I2C:TECHnology	376
BUS:LIN:BITRate	412
BUS:LIN:DATA:SOURce	411
BUS:LIN:DATA:THReshold	412
BUS:LIN:FCOunt?	416
BUS:LIN:FRAMe<m>:BYTE<n>:STATe?	416
BUS:LIN:FRAMe<m>:BYTE<n>:VALue?	416
BUS:LIN:FRAMe<m>:CSState?	417
BUS:LIN:FRAMe<m>:CSValue?	417
BUS:LIN:FRAMe<m>:DATA?	417
BUS:LIN:FRAMe<m>:IDPValue?	418
BUS:LIN:FRAMe<m>:IDState?	418
BUS:LIN:FRAMe<m>:IDValue?	418
BUS:LIN:FRAMe<m>:START?	419
BUS:LIN:FRAMe<m>:STATus?	419
BUS:LIN:FRAMe<m>:STOP?	419
BUS:LIN:FRAMe<m>:SYMBol?	419
BUS:LIN:FRAMe<m>:SYSTate?	420
BUS:LIN:POLarity	412
BUS:LIN:STANdard	412
BUS:LIN:TECHnology	413
BUS:SETReflevels	376
BUS:SETReflevels	387
BUS:SETReflevels	394
BUS:SETReflevels	401
BUS:SETReflevels	413
BUS:SPI:FCOunt?	390
BUS:SPI:FRAMe<m>:DATA?	390
BUS:SPI:FRAMe<m>:START?	391
BUS:SPI:FRAMe<m>:STATus?	390
BUS:SPI:FRAMe<m>:STOP?	391
BUS:SPI:FRAMe<m>:WCOunt?	391
BUS:SPI:FRAMe<m>:WORD<n>:MISO?	391
BUS:SPI:FRAMe<m>:WORD<n>:MOSI?	392
BUS:SPI:FRAMe<m>:WORD<n>:START?	392
BUS:SPI:FRAMe<m>:WORD<n>:STOP?	392
BUS:SPI:MISO:SOURce	386
BUS:SPI:MISO:THReshold	387

BUS:SPI:MOSI:SOURce.....	386
BUS:SPI:MOSI:THReshold.....	387
BUS:SPI:ORDer.....	387
BUS:SPI:SCLK:SLOPe.....	386
BUS:SPI:SCLK:SOURce.....	386
BUS:SPI:SCLK:THReshold.....	387
BUS:SPI:SSEL:POLarity.....	386
BUS:SPI:SSEL:SOURce.....	386
BUS:SPI:SSEL:STATe.....	388
BUS:SPI:SSEL:THReshold.....	387
BUS:SPI:TECHnology.....	386
BUS:SPI:TImeout.....	388
BUS:SPI:WSize.....	387
BUS:TYPE.....	374
BUS:UART:BITRate.....	395
BUS:UART:FRAMemode.....	396
BUS:UART:ORDer.....	396
BUS:UART:PARity.....	395
BUS:UART:POLarity.....	394
BUS:UART:SBIT.....	395
BUS:UART:SOURce.....	393
BUS:UART:SSIZe.....	395
BUS:UART:STDBitrate.....	394
BUS:UART:TECHnology.....	394
BUS:UART:THReshold.....	394
BUS:UART:TOUT.....	396
BUS:UART:WCOunt?.....	397
BUS:UART:WORD<m>:STARt?.....	398
BUS:UART:WORD<m>:STATe?.....	398
BUS:UART:WORD<m>:STOP?.....	398
BUS:UART:WORD<m>:VALue?.....	399
BUS[:STATe].....	375
CALCulate:MATH:STATe.....	294
CALCulate:MATH:VERTical:POSition.....	295
CALCulate:MATH:VERTical:RANGe.....	295
CALCulate:MATH:VERTical:SCALe.....	295
CALCulate:MATH[:EXPReSSion][:DEFine].....	294
CHANnel<m>:BANDwidth.....	254
CHANnel<m>:COUPLing.....	254
CHANnel<m>:DATA:HEADer?.....	429
CHANnel<m>:DATA[:VALues]?.....	429
CHANnel<m>:DESKew.....	255
CHANnel<m>:HISTory:CURRent.....	298
CHANnel<m>:HISTory:NSEGments.....	297
CHANnel<m>:HISTory:PLAY.....	299
CHANnel<m>:HISTory:REPLay.....	299
CHANnel<m>:HISTory:STARt.....	298
CHANnel<m>:HISTory:STOP.....	298
CHANnel<m>:HISTory:TPACq.....	297
CHANnel<m>:HISTory:TSABbsolute?.....	299

CHANnel<m>:HISTory:TSDate?.....	299
CHANnel<m>:HISTory:TSRelative?.....	300
CHANnel<m>:HISTory[:STATe].....	297
CHANnel<m>:OFFSet.....	254
CHANnel<m>:POSition.....	253
CHANnel<m>:RANGe.....	253
CHANnel<m>:SCALe.....	253
CHANnel<m>:STATe.....	252
CHANnel<m>:THReshold:FINDlevel.....	257
CHANnel<m>:THReshold:TECHnology.....	255
CHANnel<m>:THReshold:THReshold?.....	256
CHANnel<m>:THReshold:USER.....	256
COUNter<m>:ABORT.....	359
COUNter<m>:CALCulate:AVERage:ALL?.....	359
COUNter<m>:CALCulate:AVERage:AVERage?.....	359
COUNter<m>:CALCulate:AVERage:CLear.....	359
COUNter<m>:CALCulate:AVERage:COUNt:CURRent?.....	360
COUNter<m>:CALCulate:AVERage:MAXimum?.....	360
COUNter<m>:CALCulate:AVERage:MINimum?.....	360
COUNter<m>:CONFigure:FREQUency.....	361
COUNter<m>:CONFigure:VALue?.....	361
COUNter<m>:FETCh?.....	361
COUNter<m>:INITiate.....	362
COUNter<m>:MEASure:FREQUency?.....	362
COUNter<m>:READ?.....	363
COUNter<m>:SENSe:FUNcTion.....	363
COUNter<m>:SENSe:RANGe.....	363
COUNter<m>:SENSe:REFerence:STATe.....	363
COUNter<m>:SENSe:REFerence:VALue.....	364
COUNter<m>:SENSe:SOURce.....	364
COUNter<m>:SENSe:STATe.....	364
COUNter<m>:SENSe:TRIGger:MODE.....	364
CURSor:COUPling.....	291
CURSor:DELTA?.....	292
CURSor:FUNcTion.....	290
CURSor:ITDelta?.....	292
CURSor:MEASurement<m>:RESult:ACTual?.....	293
CURSor:MEASurement<m>:RESult:LIMit?.....	293
CURSor:MEASurement<m>:TYPE.....	291
CURSor:SCPLing.....	291
CURSor:SCReen.....	291
CURSor:SOURce.....	290
CURSor:STATe.....	290
CURSor:TDELTA?.....	292
CURSor:X1Position.....	292
CURSor:X2Position.....	292
CURSor:Y1AMplitude?.....	293
CURSor:Y1Position.....	293
CURSor:Y2AMplitude?.....	293
CURSor:Y2Position.....	293

DISPlay:CONTRast.....	438
DISPlay:LCD.....	438
DISPlay:MOUS.....	438
DISPlay:PERSistence:TIME.....	438
DISPlay:PERSistence[:TYPE].....	437
EXPort:WAVEform:DLOGging.....	426
EXPort:WAVEform:INCXvalues.....	426
EXPort:WAVEform:MULTichannel.....	426
EXPort:WAVEform:NAME.....	425
EXPort:WAVEform:SAVE.....	427
EXPort:WAVEform:SOURce.....	425
FORMat:BORDER.....	428
FORMat[:DATA].....	428
HARMonic:AVERAge.....	319
HARMonic:CLEar.....	319
HARMonic:DISPlay:TYPE.....	319
HARMonic:DISPlay:USER.....	320
HARMonic:EXPort:NAME.....	323
HARMonic:EXPort:SAVE.....	324
HARMonic:FUNDamental:CURRent?.....	320
HARMonic:FUNDamental:TYPE.....	320
HARMonic:FUNDamental:USER.....	321
HARMonic:LIMits:CURRent?.....	321
HARMonic:LIMits:LOAD.....	321
HARMonic:LIMits:NAME.....	322
HARMonic:LIMits:TYPE.....	322
HARMonic:RESult<m>:CLIPping?.....	324
HARMonic:RESult<m>:FRQMissing?.....	324
HARMonic:RESult<m>:FUNDamental?.....	325
HARMonic:RESult<m>:HARMonics<n>:ABSMagnitude:MAXimum?.....	325
HARMonic:RESult<m>:HARMonics<n>:ABSMagnitude:MINimum?.....	325
HARMonic:RESult<m>:HARMonics<n>:ABSMagnitude[:CURRent]?.....	325
HARMonic:RESult<m>:HARMonics<n>:LIMCheck?.....	325
HARMonic:RESult<m>:HARMonics<n>:LIMit?.....	326
HARMonic:RESult<m>:HARMonics<n>:LIMViolation?.....	326
HARMonic:RESult<m>:HARMonics<n>:PHASe?.....	327
HARMonic:RESult<m>:HARMonics<n>:RELMagnitude:MAXimum?.....	328
HARMonic:RESult<m>:HARMonics<n>:RELMagnitude:MINimum?.....	328
HARMonic:RESult<m>:HARMonics<n>:RELMagnitude[:CURRent]?.....	328
HARMonic:RESult<m>:HARMonics<n>[:FREQuency]?.....	328
HARMonic:RESult<m>:LIMViolation?.....	328
HARMonic:RESult<m>:NOHarmonics?.....	329
HARMonic:RESult<m>:NOResults?.....	329
HARMonic:RESult<m>:RMS:MAXimum?.....	329
HARMonic:RESult<m>:RMS:MINimum?.....	329
HARMonic:RESult<m>:RMS[:CURRent]?.....	329
HARMonic:RESult<m>:THD:MAXimum?.....	330
HARMonic:RESult<m>:THD:MINimum?.....	330
HARMonic:RESult<m>:THD[:CURRent]?.....	330
HARMonic:SCALE.....	322

HARMonic:STATistic.....	322
HARMonic:THDType.....	323
HCOPY:COLor.....	430
HCOPY:IMMEDIATE.....	430
HCOPY:INVERSE.....	430
HCOPY:LANGUage.....	430
LOGGer:ACLR.....	367
LOGGer:CURSor:COUPLing.....	368
LOGGer:CURSor:RESult<n>:DELTA?.....	368
LOGGer:CURSor:SCPLing.....	367
LOGGer:CURSor:SCReen.....	368
LOGGer:CURSor:STATe.....	367
LOGGer:CURSor:TDELta?.....	369
LOGGer:CURSor:TYPE.....	367
LOGGer:CURSor<m>:POSition?.....	369
LOGGer:CURSor<m>:RESult<n>[:AMPLitude]?.....	368
LOGGer:MEASurement<m>:ENABled?.....	372
LOGGer:MEASurement<m>:RESult:CURRentsampl?.....	371
LOGGer:MEASurement<m>:RESult:MAXimum:POSition?.....	371
LOGGer:MEASurement<m>:RESult:MAXimum:VALue?.....	371
LOGGer:MEASurement<m>:RESult:MEAN?.....	372
LOGGer:MEASurement<m>:RESult:MINimum:POSition?.....	371
LOGGer:MEASurement<m>:RESult:MINimum:VALue?.....	372
LOGGer:MEASurement<m>:RESult:STDDev?.....	372
LOGGer:MEASurement<m>:SOURce?.....	373
LOGGer:MEASurement<m>:TYPE?.....	373
LOGGer:RECORDing:START?.....	370
LOGGer:RECORDing:TOTAL?.....	370
LOGGer:SLOT:ACTive?.....	373
LOGGer:SLOT:CLEar.....	366
LOGGer:SLOT:CURRent.....	366
LOGGer:SLOT:EXPort:NAME.....	374
LOGGer:SLOT:EXPort:SAVE.....	374
LOGGer:SLOT:LOAD.....	366
LOGGer:SOURce.....	365
LOGGer:TIMEbase:SCALE.....	366
LOGGer:TIMEbase:SRATE.....	365
LOGGer:ZOOM:ENABle.....	369
LOGGer:Zoom:POSition?.....	370
LOGGer:ZOOM:SCALE.....	369
LOGic:CHANnel<m>:DESKew.....	423
LOGic:GROup<m>:HYSTEResis.....	423
LOGic:GROup<m>:TECHnology.....	421
LOGic:GROup<m>:THREShold?.....	422
LOGic:GROup<m>:USER.....	422
LOGic:STATe.....	421
LOGic:THCOuPLing.....	421
MASK:CHANnel<m>:CREAtEmask.....	301
MASK:CHANnel<m>:PROPerties:XWIDth.....	300
MASK:CHANnel<m>:PROPerties:YWIDth.....	301

MASK:CHANnel<m>:RESult:FAIL:PERcentage?	302
MASK:CHANnel<m>:RESult:FAIL[:COUNT]?	302
MASK:CHANnel<m>:RESult:PASS:PERcentage?	303
MASK:CHANnel<m>:RESult:PASS[:COUNT]?	303
MASK:CHANnel<m>:RESult:TOTL[:COUNT]?	303
MASK:CHANnel<m>:STATe	300
MASK:ELAPsedtime:TOTal?	303
MASK:ELAPsedtime[:SECS]?	304
MASK:ONViolation[:SELection]	301
MASK:RST	302
MASK[:TESTstate]?	302
MEASurement<m>:AOFF	289
MEASurement<m>:DELay:SLOPe	289
MEASurement<m>:ENABle	287
MEASurement<m>:RESult:ACTual?	289
MEASurement<m>:RESult:LIMit?	289
MEASurement<m>:SOURce	288
MEASurement<m>:TYPE	288
METer:CONFigure:CAPacitance	332
METer:CONFigure:CONTInuity	332
METer:CONFigure:CURRent:AC	333
METer:CONFigure:CURRent:DC	333
METer:CONFigure:DIODE	332
METer:CONFigure:FREQuency	333
METer:CONFigure:RESistance	333
METer:CONFigure:TEMPerature	332
METer:CONFigure:VALue?	341
METer:CONFigure:VOLTag:e:AC	333
METer:CONFigure:VOLTag:e:DC	333
METer:MEASure:CAPacitance?	344
METer:MEASure:CONTInuity?	343
METer:MEASure:CURRent:AC?	344
METer:MEASure:CURRent:DC?	344
METer:MEASure:DIODE?	343
METer:MEASure:FREQuency?	343
METer:MEASure:RESistance?	344
METer:MEASure:TEMPerature?	343
METer:MEASure:VOLTag:e:AC?	344
METer:MEASure:VOLTag:e:DC?	344
METer:SENSe:CAPacitance:NULL:STATe	338
METer:SENSe:CAPacitance:NULL:VALue	339
METer:SENSe:CAPacitance:RANGe:AUTO	336
METer:SENSe:CAPacitance:RANGe:UPPer	334
METer:SENSe:CURRent:AC:NULL:STATe	338
METer:SENSe:CURRent:AC:NULL:VALue	339
METer:SENSe:CURRent:AC:RANGe:AUTO	336
METer:SENSe:CURRent:AC:RANGe:UPPer	334
METer:SENSe:CURRent:DC:NULL:STATe	338
METer:SENSe:CURRent:DC:NULL:VALue	339
METer:SENSe:CURRent:DC:RANGe:AUTO	336

METer:SENSe:CURRent:DC:RANGe:UPPer.....	334
METer:SENSe:FREQUency:VOLTagE:RANGe:AUTO.....	336
METer:SENSe:FREQUency:VOLTagE:RANGe:UPPer.....	335
METer:SENSe:FUNcTION.....	341
METer:SENSe:RESistance:NULL:STATe.....	338
METer:SENSe:RESistance:NULL:VALue.....	340
METer:SENSe:RESistance:RANGe:AUTO.....	336
METer:SENSe:RESistance:RANGe:UPPer.....	335
METer:SENSe:TEMPerature:NULL:STATe.....	338
METer:SENSe:TEMPerature:NULL:VALue.....	340
METer:SENSe:TEMPerature:TRANsductor:RTD:TYPE.....	338
METer:SENSe:VOLTagE:AC:NULL:STATe.....	338
METer:SENSe:VOLTagE:AC:NULL:VALue.....	339
METer:SENSe:VOLTagE:AC:RANGe:AUTO.....	336
METer:SENSe:VOLTagE:AC:RANGe:UPPer.....	335
METer:SENSe:VOLTagE:DC:NULL:STATe.....	338
METer:SENSe:VOLTagE:DC:NULL:VALue.....	339
METer:SENSe:VOLTagE:DC:RANGe:AUTO.....	336
METer:SENSe:VOLTagE:DC:RANGe:UPPer.....	335
METer:UNIT:TEMPerature.....	337
METer<m>:ABORt.....	342
METer<m>:ABORt.....	354
METer<m>:CALCulate:AVERage:AVERage?.....	345
METer<m>:CALCulate:AVERage:AVERage?.....	357
METer<m>:CALCulate:AVERage:CLear.....	346
METer<m>:CALCulate:AVERage:CLear.....	358
METer<m>:CALCulate:AVERage:MAXimum?.....	346
METer<m>:CALCulate:AVERage:MAXimum?.....	358
METer<m>:CALCulate:AVERage:MINimum?.....	345
METer<m>:CALCulate:AVERage:MINimum?.....	357
METer<m>:CONFigure:CURRent:AC.....	348
METer<m>:CONFigure:CURRent:DC.....	348
METer<m>:CONFigure:VALue?.....	354
METer<m>:CONFigure:VOLTagE:AC.....	349
METer<m>:CONFigure:VOLTagE:DC.....	349
METer<m>:FETCh?.....	343
METer<m>:FETCh?.....	355
METer<m>:INITiate.....	342
METer<m>:INITiate.....	355
METer<m>:MEASure:CURRent:AC?.....	356
METer<m>:MEASure:CURRent:DC?.....	356
METer<m>:MEASure:VOLTagE:AC?.....	356
METer<m>:MEASure:VOLTagE:DC?.....	356
METer<m>:READ?.....	342
METer<m>:READ?.....	355
METer<m>:SENSe:CURRent:AC:COUPling.....	337
METer<m>:SENSe:CURRent:AC:COUPling.....	350
METer<m>:SENSe:CURRent:AC:NULL:STATe.....	352
METer<m>:SENSe:CURRent:AC:NULL:VALue.....	352
METer<m>:SENSe:CURRent:AC:RANGe:UPPer.....	349

METer<m>:SENSe:CURRent:DC:NULL:STATe.....	352
METer<m>:SENSe:CURRent:DC:NULL:VALue.....	352
METer<m>:SENSe:CURRent:DC:RANGe:UPPer.....	349
METer<m>:SENSe:FUNcTion.....	353
METer<m>:SENSe:NULL:STATe.....	339
METer<m>:SENSe:NULL:STATe.....	352
METer<m>:SENSe:NULL:VALU.....	340
METer<m>:SENSe:NULL:VALU.....	353
METer<m>:SENSe:RANGe.....	348
METer<m>:SENSe:RELative:STATe.....	339
METer<m>:SENSe:RELative:STATe.....	352
METer<m>:SENSe:SOURce.....	347
METer<m>:SENSe:STATe.....	347
METer<m>:SENSe:VOLTage:AC:COUPling.....	337
METer<m>:SENSe:VOLTage:AC:COUPling.....	350
METer<m>:SENSe:VOLTage:AC:NULL:STATe.....	352
METer<m>:SENSe:VOLTage:AC:NULL:VALue.....	352
METer<m>:SENSe:VOLTage:AC:RANGe:UPPer.....	350
METer<m>:SENSe:VOLTage:DC:NULL:STATe.....	352
METer<m>:SENSe:VOLTage:DC:NULL:VALue.....	352
METer<m>:SENSe:VOLTage:DC:RANGe:UPPer.....	350
METer<m>:TRIGger:MODE.....	341
METer<m>:TRIGger:MODE.....	354
MMEMory:CATalog:LENGth?.....	435
MMEMory:CATalog?.....	434
MMEMory:CDIRectory.....	432
MMEMory:COPI.....	435
MMEMory:DATA.....	432
MMEMory:DCATalog:LENGth?.....	434
MMEMory:DCATalog?.....	433
MMEMory:DELeTe.....	436
MMEMory:MDIRectory.....	432
MMEMory:MOVE.....	435
MMEMory:NAME.....	430
MMEMory:RCL.....	431
MMEMory:RDIRectory.....	433
MMEMory:SAV.....	431
OP[:MODE].....	251
OP[:MODE].....	330
POD:STATe?.....	424
REFCurve:DELeTe.....	296
REFCurve:NAME.....	296
REFCurve:OPEN.....	296
REFCurve:POSItion.....	296
REFCurve:SAVE.....	296
REFCurve:SOURce.....	295
REFCurve:STATe.....	296
REFCurve:UPDate.....	295
RUN.....	258
SPECtrum:CURSor<m>:COUPling.....	312

SPECTrum:CURSor<m>:FREQuency:DELTA?	313
SPECTrum:CURSor<m>:FREQuency[:VALue]	313
SPECTrum:CURSor<m>:LEVel:DELTA?	313
SPECTrum:CURSor<m>:LEVel[:VALue]?	313
SPECTrum:CURSor<m>:SCPLing	312
SPECTrum:CURSor<m>:SCReen	314
SPECTrum:CURSor<m>:SOURce	312
SPECTrum:CURSor<m>:STATe	311
SPECTrum:EXPort:INCXvalues	318
SPECTrum:EXPort:NAME	318
SPECTrum:EXPort:SAVE	318
SPECTrum:FREQuency:AVERAge:COUNt	308
SPECTrum:FREQuency:BANDwidth[:RESolution]:AUTO	309
SPECTrum:FREQuency:BANDwidth[:RESolution]:RATio	309
SPECTrum:FREQuency:BANDwidth[:RESolution][:VALue]	305
SPECTrum:FREQuency:CENTer	305
SPECTrum:FREQuency:FULLspan	309
SPECTrum:FREQuency:HORizontal:SCALE	305
SPECTrum:FREQuency:MAGNitude:REFerence[:VALue]	309
SPECTrum:FREQuency:MAGNitude:SCALE	305
SPECTrum:FREQuency:POSition	310
SPECTrum:FREQuency:RESet	311
SPECTrum:FREQuency:SAMPle?	306
SPECTrum:FREQuency:SCALE	310
SPECTrum:FREQuency:SPAN:MODE	306
SPECTrum:FREQuency:SPAN[:VALue]	306
SPECTrum:FREQuency:START	306
SPECTrum:FREQuency:STOP	307
SPECTrum:FREQuency:WINDow:FACTor?	307
SPECTrum:FREQuency:WINDow:TYPE	307
SPECTrum:MARKer:COUNt	314
SPECTrum:MARKer:RCOUNt?	316
SPECTrum:MARKer:RESult<m>:FREQuency:DELTA?	316
SPECTrum:MARKer:RESult<m>:FREQuency[:VALue]?	316
SPECTrum:MARKer:RESult<m>:LEVel:DELTA?	317
SPECTrum:MARKer:RESult<m>:LEVel[:VALue]?	317
SPECTrum:MARKer:RMARker:FREQuency?	317
SPECTrum:MARKer:RMARker:VALue?	318
SPECTrum:MARKer:SETup:DISTance	315
SPECTrum:MARKer:SETup:EXCursion	315
SPECTrum:MARKer:SETup:MLEVel	315
SPECTrum:MARKer:SOURce	315
SPECTrum:MARKer[:STATe]	314
SPECTrum:MODE?	308
SPECTrum:SOURce	304
SPECTrum:WAVeform:AVERAge[:ENABLE]	310
SPECTrum:WAVeform:MAXimum[:ENABLE]	311
SPECTrum:WAVeform:MINimum[:ENABLE]	311
SPECTrum:WAVeform:SPECTrum[:ENABLE]	311
STOP	259

SYSTem:COMMunicate:WLAN:MODE.....	438
SYSTem:DATE.....	436
SYSTem:TIME.....	437
TI梅base:HORizontal:POSition.....	257
TI梅base:RANGe.....	257
TI梅base:REFerence.....	258
TI梅base:SCALe.....	257
TRIGger:CAN:ACKerror.....	402
TRIGger:CAN:BITSterror.....	402
TRIGger:CAN:CRCError.....	402
TRIGger:CAN:DATA.....	403
TRIGger:CAN:DCONDition.....	403
TRIGger:CAN:FORMerror.....	403
TRIGger:CAN:FTYPE.....	403
TRIGger:CAN:ICONDition.....	404
TRIGger:CAN:IDENTifier.....	404
TRIGger:CAN:ITYPe.....	405
TRIGger:CAN:TYPE.....	405
TRIGger:DATatoclock:CONDition.....	279
TRIGger:DATatoclock:CSource:EDGE.....	279
TRIGger:DATatoclock:CSource[:VALue].....	279
TRIGger:DATatoclock:DSource[:VALue].....	279
TRIGger:DATatoclock:HTIME.....	280
TRIGger:DATatoclock:STIME.....	280
TRIGger:EDGE:SLOPe.....	264
TRIGger:EXTernal:LEVel.....	270
TRIGger:EXTernal:SLOPe.....	271
TRIGger:GLITch:POLarity.....	264
TRIGger:GLITch:RANGe.....	265
TRIGger:GLITch:WIDTh.....	265
TRIGger:HOLDoff:EVENTs.....	263
TRIGger:HOLDoff:MAX.....	263
TRIGger:HOLDoff:MIN.....	263
TRIGger:HOLDoff:MODE.....	262
TRIGger:HOLDoff:TIME.....	263
TRIGger:I2C:ACCess.....	377
TRIGger:I2C:ACONDition.....	378
TRIGger:I2C:ADDRess.....	378
TRIGger:I2C:ADNack.....	377
TRIGger:I2C:DATA.....	378
TRIGger:I2C:DCONDition.....	378
TRIGger:I2C:DPOSition.....	379
TRIGger:I2C:DRNack.....	377
TRIGger:I2C:DWNack.....	377
TRIGger:I2C:MODE.....	377
TRIGger:INTerval:DELTA.....	283
TRIGger:INTerval:MAXWidth.....	284
TRIGger:INTerval:MINWidth.....	283
TRIGger:INTerval:RANGe.....	283
TRIGger:INTerval:SLOPe.....	282

TRIGger:INTerval:WIDTh.....	283
TRIGger:LEVel<m>:RUNT:LOWer.....	275
TRIGger:LEVel<m>:RUNT:UPPer.....	275
TRIGger:LEVel<m>:SLEW:LOWer.....	277
TRIGger:LEVel<m>:SLEW:UPPer.....	277
TRIGger:LEVel<m>:VALue.....	262
TRIGger:LEVel<m>:WINDow:LOWer.....	284
TRIGger:LEVel<m>:WINDow:UPPer.....	284
TRIGger:LIN:CHKSError.....	413
TRIGger:LIN:DATA.....	414
TRIGger:LIN:DCONdition.....	414
TRIGger:LIN:ICONdition.....	414
TRIGger:LIN:IDENtifier.....	414
TRIGger:LIN:IPERror.....	415
TRIGger:LIN:SYERror.....	415
TRIGger:LIN:TYPE.....	415
TRIGger:MNR.....	264
TRIGger:MODE.....	261
TRIGger:PATtern:STATe:COMBination.....	271
TRIGger:PATtern:STATe[:CHANnel<m>].....	271
TRIGger:PATtern:TIMEout[:TIME].....	272
TRIGger:PATtern:WIDTh:DELTA.....	273
TRIGger:PATtern:WIDTh:MAXWidth.....	273
TRIGger:PATtern:WIDTh:MINWidth.....	273
TRIGger:PATtern:WIDTh:RANGe.....	272
TRIGger:PATtern:WIDTh[:WIDTh].....	272
TRIGger:RUNT:DELTA.....	276
TRIGger:RUNT:MAXWidth.....	277
TRIGger:RUNT:MINWidth.....	276
TRIGger:RUNT:POLarity.....	275
TRIGger:RUNT:RANGe.....	275
TRIGger:RUNT:WIDTh.....	276
TRIGger:SLEW:DELTA.....	278
TRIGger:SLEW:MAXWidth.....	279
TRIGger:SLEW:MINWidth.....	278
TRIGger:SLEW:RANGe.....	277
TRIGger:SLEW:RATE.....	278
TRIGger:SLEW:SLOPe.....	277
TRIGger:SOURce.....	261
TRIGger:SPATtern:CSOURce:EDGE.....	281
TRIGger:SPATtern:CSOURce:FIRStedge.....	281
TRIGger:SPATtern:CSOURce[:VALue].....	281
TRIGger:SPATtern:DSOURce[:VALue].....	280
TRIGger:SPATtern:ORDer.....	281
TRIGger:SPATtern:PATtern.....	281
TRIGger:SPI:DATA.....	389
TRIGger:SPI:DCONdition.....	389
TRIGger:SPI:DPOStion.....	389
TRIGger:SPI:DSRC.....	389
TRIGger:SPI:MODE.....	388

TRIGger:STATe:CHANnel<m>.....	274
TRIGger:STATe:COMBination.....	274
TRIGger:STATe:CSORuce:EDGE.....	274
TRIGger:STATe:CSORuce[:VALue].....	274
TRIGger:TIMEout:RANGe.....	282
TRIGger:TIMEout:TIME.....	282
TRIGger:TV:CUSTom:LDURation.....	270
TRIGger:TV:CUSTom:SCANmode.....	270
TRIGger:TV:CUSTom:SDURation.....	270
TRIGger:TV:CUSTom:STYPe.....	269
TRIGger:TV:LFIeld.....	269
TRIGger:TV:LINE.....	269
TRIGger:TV:MODE.....	268
TRIGger:TV:POLarity.....	268
TRIGger:TV:STANdard.....	267
TRIGger:TYPE.....	261
TRIGger:UART:DATA.....	397
TRIGger:UART:DCONDition.....	397
TRIGger:UART:TYPE.....	396
TRIGger:WIDTh:DELTA.....	266
TRIGger:WIDTh:MAX.....	266
TRIGger:WIDTh:MIN.....	267
TRIGger:WIDTh:POLarity.....	265
TRIGger:WIDTh:RANGe.....	265
TRIGger:WIDTh:WIDTh.....	266
TRIGger:WINDow:DELTA.....	286
TRIGger:WINDow:MAXWidth.....	286
TRIGger:WINDow:MINWidth.....	286
TRIGger:WINDow:RANGe.....	285
TRIGger:WINDow:TIME.....	284
TRIGger:WINDow:WIDTh.....	285
ZOOM:ENABle.....	286
ZOOM:POSition.....	287
ZOOM:SCALe.....	287