

CYCLON SELECTION GUIDE

THIRD EDITION





Global Headquarters

P.O. Box 14145 Reading,
PA 196212-4145
USA

Tel: +1-610-208-1991
+1-800-538-3627
Fax: +1-610-372-8613

EnerSys EMEA

Brussels, Belgium
Tel: +32 (0)2 247 94 47

EnerSys Asia

Guangdong, China
Tel: +86-755-2689 3639



TABLE OF CONTENTS

Company background

EnerSys, Inc.....2
 Services and applications3
 Features and benefits.....4

Technical information

Capacity as a function of temperature.....6
 State of charge.....6
 Storage time as a function of temperature.....7
 Voltage regulation7
 Charging8

CYCLON Single Cells

CYCLON product family9
 CYCLON alternate battery configurations10
 CYCLON standard battery descriptions.....11
 CYCLON Single Cell performance specifications12
 CYCLON Single Cell standard assemblies.....13
 CYCLON BC Single Cell performance specifications.....14
 CYCLON Single Cell mechanical specifications.....15
 CYCLON Single Cell constant current (CC)
 and constant power (CP) discharge graphs.....16

CYCLON Monobloc

4V/6V Monobloc performance specifications17
 4V/6V Monobloc standard assemblies.....18
 4V/6V Monobloc mechanical specifications.....19
 4V/6V Monobloc constant current (CC)
 and constant power (CP) discharge graphs.....20

Quick reference list

Standard product listinginside back cover



ENERSYS, INC.

EnerSys, Inc. is the world's largest industrial battery manufacturer. Headquartered in Reading, PA, USA, EnerSys has 22 manufacturing and assembly plants, over 7,000 employees, and a worldwide sales and distribution network. A leader in both valve-regulated and flooded lead acid battery technologies, EnerSys is a major supplier to telecommunications, UPS, data processing, electronic, and material handling markets across the globe.

EnerSys, Inc. operates several of the first lead acid battery plants in the United States to receive the ISO 9001 certificates of registration, covering the company's product design, manufacturing, assembly, and customer service functions. ISO 9001 certification, covering 20 key elements, assures customers that EnerSys has fully documented and implemented manufacturing and quality systems that are consistently followed.



EnerSys' environmentally progressive Warrensburg, Missouri plant, home base of the CYCLON product lines, covers 320,000 square feet on 33 acres and employs more than 400 people. EnerSys was the first battery company in the United States to receive ISO 14001 certification. ISO 14001 focuses on the environmental management system of the business and provides a systematic approach to resource conservation.

EnerSys supports its customers through global field sales offices and a select network of authorized Value Added Centers and international representatives and distributors. EnerSys offers technical support and customer service unparalleled in the industry. Additionally, the sales and support team is committed to meeting and exceeding the individual needs of each customer.

EnerSys' Warrensburg plant covers 320,000 square feet and is situated on 33 acres

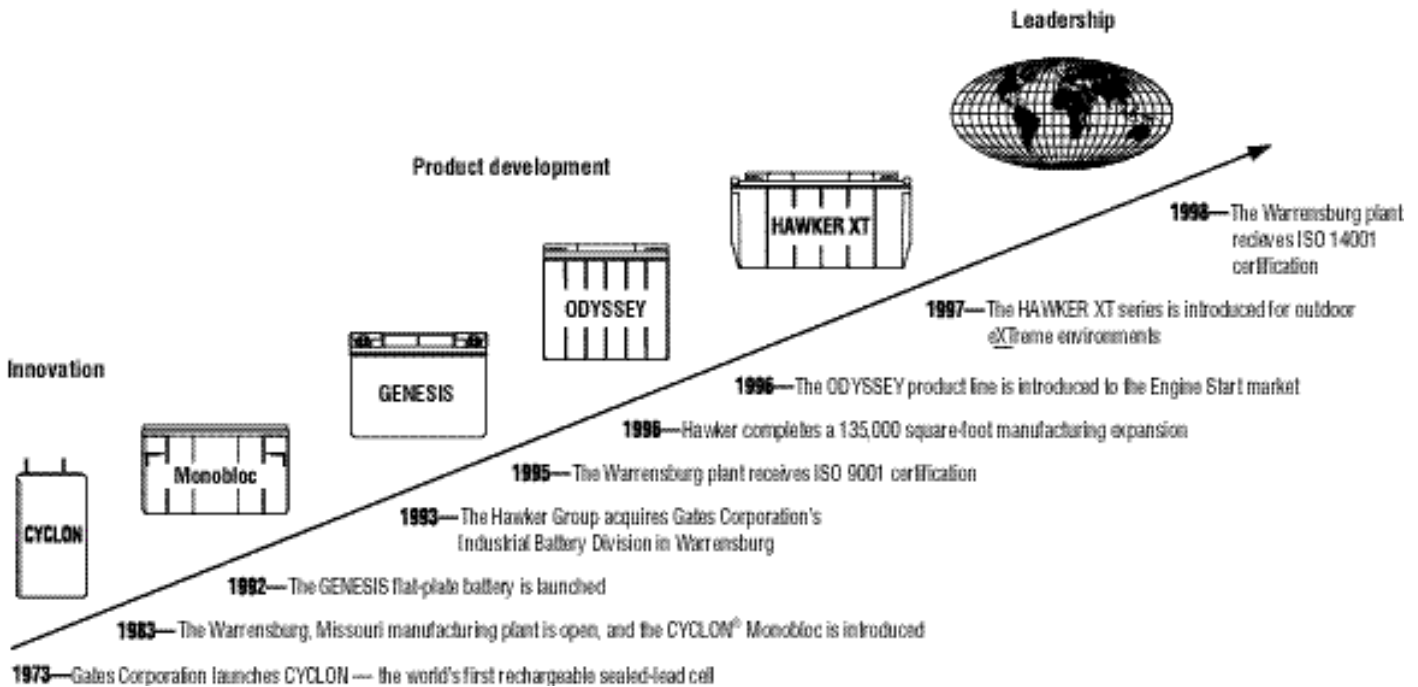



VALUE-ADDED SERVICES

In addition to our manufacturing capability, EnerSys is proud to provide its customers with the following services:

- customized manufacturing design
- battery recycling
- on-line Internet technical information
- charging support
- product testing
- on-site technical seminars
- battery samples
- application engineering
- technical documentation

APPLICATIONS

Batteries from EnerSys' "pure lead-tin" family are used in a wide variety of standby and portable/cyclic applications including those in:

- telecommunications
- electronics
- uninterruptible power supplies
- defense installations
- aviation
- computer back-up
- electric vehicles
- medical equipment
- solar power
- lawn and garden equipment
- specialty engine start



FEATURES AND BENEFITS

Sealed pure-lead cells were invented by the Gates Corporation in 1973. The purity of the materials used is key to supporting this lead-battery's performance benefits. A longer service life, meaning fewer replacements and the cost associated with it, combined with higher reliability and fewer system failures, result in a lower long-term cost of ownership to the end user or equipment owner.

What are the advantages of EnerSys technology?

1 POWER DENSITY—Per unit weight, the power provided by pure lead-tin products offers the greatest high-rate power density for your energy dollar. CYCLON's greater volumetric power allows engineers to consider more energy-supporting features or design smaller, lighter packages.

At high-rate and pulse discharges, EnerSys' CYCLON products offer the best performance value when compared with competitive product in applications at less than 100 minutes of discharge.

2 CYCLE LIFE—Compared to competitive lead products (offering up to 200 full cycles), pure lead-tin batteries provide 50% to 200% greater full cycle capability. CYCLON product will deliver more than 300 cycles (100% DOD, C/5). And, because CYCLON incorporates a high vent-pressure design, EnerSys' products experience no "dry out" failure mode from repeated recharges.

3 FLOAT LIFE—Conventional sealed-lead batteries vary greatly in specified standby life: from three to six years at 20° C, C/20. CYCLON, however, offers a ten-year design life at 25° C, C/5, to 80% of rated capacity. At 20° C, CYCLON single cells offer a fifteen-year design life.

4 HIGH STABLE VOLTAGE DELIVERY—The high stable voltage delivery of a pure lead-tin battery results from its low internal resistance. The flat discharge voltage profile of our batteries, similar to nickel cadmium, combined with our products' low internal resistance,

means our batteries are able to discharge and recharge their power more quickly and efficiently and offer greater application flexibility. The pure lead-tin construction also gives more watts-per-unit weight at high discharge rates.

5 WIDEST TEMPERATURE RANGE—Due to the product's strong construction and high vent pressures, these cells will maintain their performance and physical parameters in extreme conditions. At high temperatures, the chemical reaction in a battery that causes aging is accelerated. Pure lead-tin technology resists that chemical reaction more effectively than alloyed lead, thus allowing a battery to have a longer service life. At high temperatures, when conventional lead batteries experience internal moisture loss from venting and case side wall distention, the CYCLON Single Cell, with its steel can (jacket) and 50psi vent, does not experience these life-robbing conditions. CYCLON has twice the delivered capacity of conventional sealed-lead batteries at temperatures below -20° C, offering unparalleled low-temperature performance.

Our batteries have thinner plates, and therefore greater plate surface area than conventional sealed-lead, thick plate batteries. As a result our batteries can reach a high state of charge in fast-charging applications in one-fourth the time of conventional, sealed-lead, thick-plate batteries. This is 50% to 100% overall better performance for your energy dollar.

6 RUGGED CONSTRUCTION—Due to their strong external packaging and internal pure lead-tin composition, EnerSys' products can withstand not only extreme temperatures but also harsh usage.

CYCLON Single Cell external cases are constructed from UL 94V-0 flame-rated materials. CYCLON products are shock and vibration resistant, designed to offer higher tolerance levels to meet demanding applications, including those in commercial and outdoor applications. The company's focus on battery-case integrity and high vent pressure, coupled with pure lead-tin's low grid-corrosion rate, means CYCLON cells and Monoblocs provide the longest service life possible.

CYCLON/MONOBLOC COMPARISON CHART

| | Design | Construction | Operating range | Voltages |
|---------------------|--------------------------|--|-----------------|------------------|
| CYCLON Single Cells | 3 atm venting pressure | Metal outer case & spiral construction | -65°C to +80°C | 2 volt cells |
| Monobloc | 0.5 atm venting pressure | Plastic outer case & spiral construction | -40°C to +40°C | 4 & 6 volt units |



THE PURE LEAD-TIN ADVANTAGE

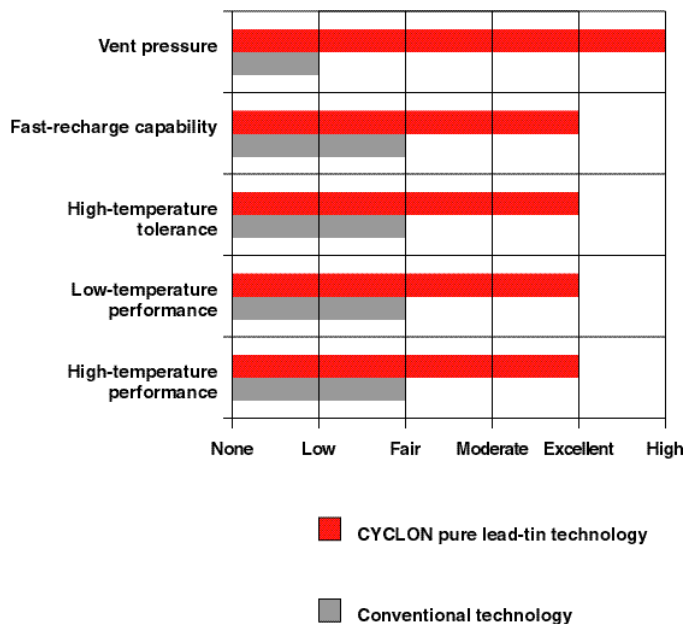

Each plastic Monobloc consists of Single Cell elements, internally connected to provide a 4 or 6 volt unit. Monoblocs or Single Cells can be connected in series or parallel to achieve the required voltage or capacity. Monoblocs and Single Cells are supplied with spade terminals making electrical connections quick and easy. Additionally, EnerSys products offer the highest vent pressure in the market. As a result, our batteries are more resistant to venting and dryout from continuous overcharge in standby applications.

7 FASTEST RECHARGE—EnerSys’ pure lead-tin chemistry allows our batteries and cells to offer the highest recharge efficiency of any sealed-lead battery on the market. With pure lead-tin, you can achieve a 95% state of recharge in less than one hour—without loss of capacity or electrolyte using conventional constant-voltage charging techniques.

Flexible charging options are possible with CYCLON Single Cells and Monoblocs, as no current limit is required when using a constant voltage charger.

8 ORIENTATION/PLACEMENT/TRANSPORT—Due to the products’ mechanical design, CYCLON can be mounted and operated in any position, an attractive feature for less accessible areas.

CYCLON Single Cells offer UL 94V-0 flame-retardant packaging, thus allowing the mounting of systems in sensitive areas and human

environments. Plus, the unique and flexible 2-volt CYCLON Single Cell allows you to design your system using an almost infinite number of packaging/design configurations.

Effective September 30, 1995, CYCLON Single Cells and Monoblocs were classified as “nonspillable batteries”, and are excepted from the Department of Transportation’s comprehensive packaging requirements if the following conditions are satisfied: (1) The battery is protected against short circuits and is securely packaged and (2) The battery and outer packaging must be plainly and durably marked “NONSPILLABLE” or “NONSPILLABLE BATTERY”. CYCLON shipments from EnerSys Warrensburg location, will be properly labeled in accordance with applicable regulations. **Packaging changes performed at other locations may require additional labeling, since in addition to the battery itself containing the required marking, the outer packaging of the battery must also contain the required marking: “NONSPILLABLE” or “NONSPILLABLE BATTERY”.**

CYCLON Single Cells and Monoblocs have been tested and determined to be in compliance with the vibration and pressure differential tests contained in 49 CFR § 173.159(d).

Because CYCLON Single Cells and Monoblocs are classified as “Nonspillable” and meet the conditions above, [from § 173.159(d)] they do not have an assigned UN number nor do they require additional DOT hazard labeling.

The regulation change effective September, 1995, was to clarify and distinguish to shippers and transporters, all batteries that have been tested and determined to be in compliance with the DOT Hazardous Material Regulations, the International Civil Aeronautics Organization (ICAO), and the International Air Transport Association (IATA) Packaging Instruction 806 and Special Provision A67, and therefore excepted from all other requirements of these regulations and classified as a “nonspillable battery”.

9 SHELF LIFE—Pure lead-tin batteries have an extremely low self-discharge rate, thus providing extended storage capability while maintaining high state-of-charge levels for dependable operation.

CYCLON Single Cells and Monoblocs have a shelf life more than two times that of conventional lead batteries. To assure maximum reliability, EnerSys recommends that all stored cells/batteries be recharged (boost charged) once every 24 months or when the open circuit voltage drops to 2.00 volts per cell, whichever occurs earlier. Inventory should be checked more frequently if storage temperature regularly exceeds 25°C.

CAPACITY AS A FUNCTION OF TEMPERATURE FOR CYCLON SINGLE CELLS & MONOBLOCS
(USE GRAPH UP TO 40°C FOR MONOBLOCS)

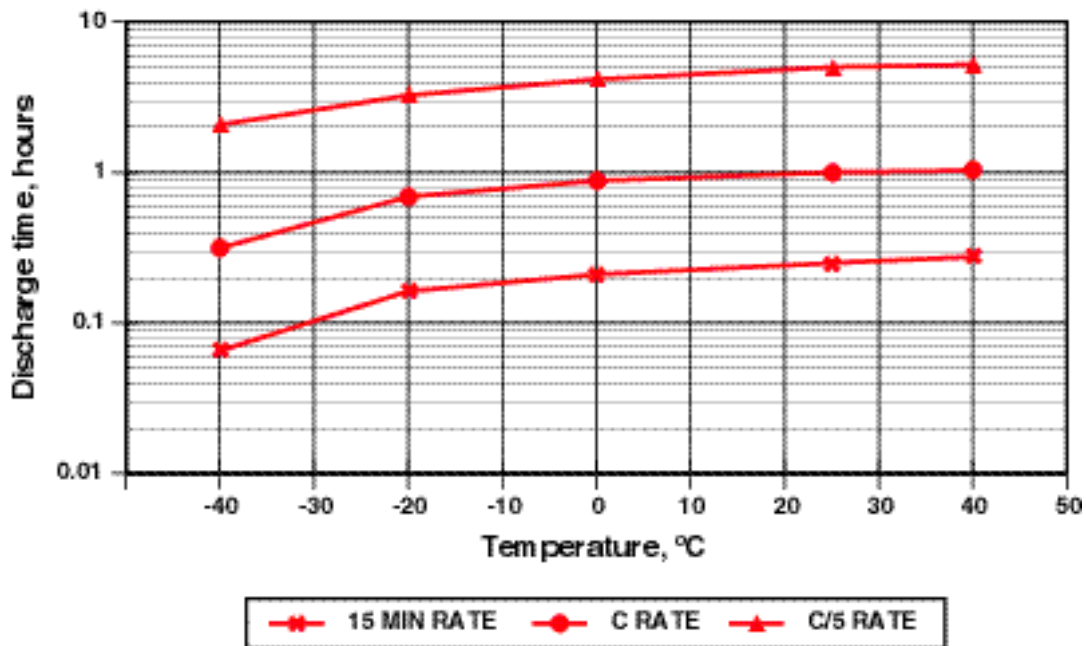

STATE OF CHARGE FOR CYCLON SINGLE CELLS & MONOBLOCS

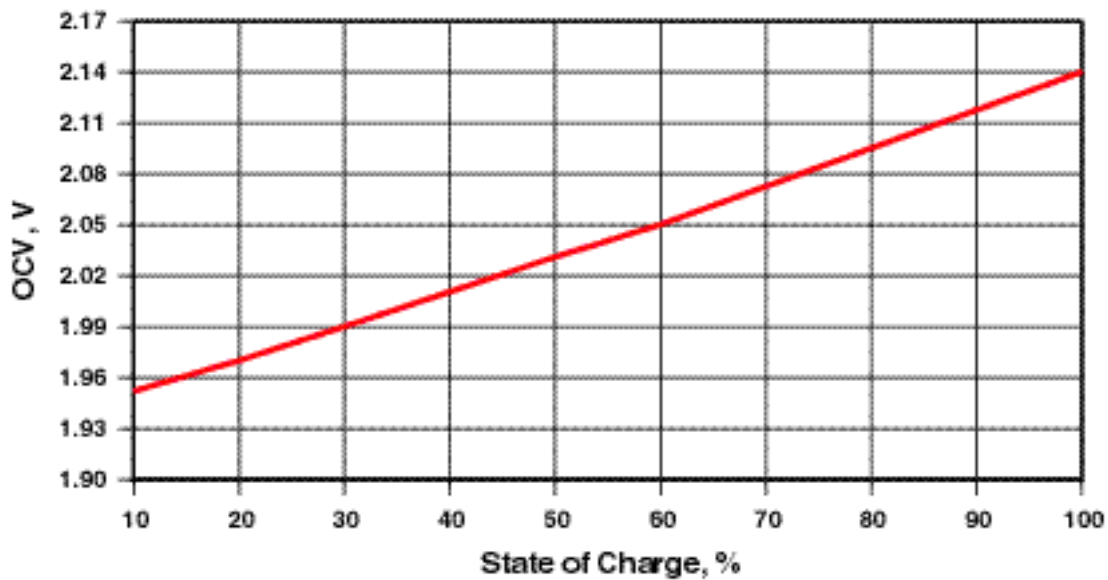



**STORAGE TIME AS A FUNCTION OF TEMPERATURE FOR CYCLON SINGLE CELLS & MONOBLOCKS
(FULLY CHARGED CELL)**

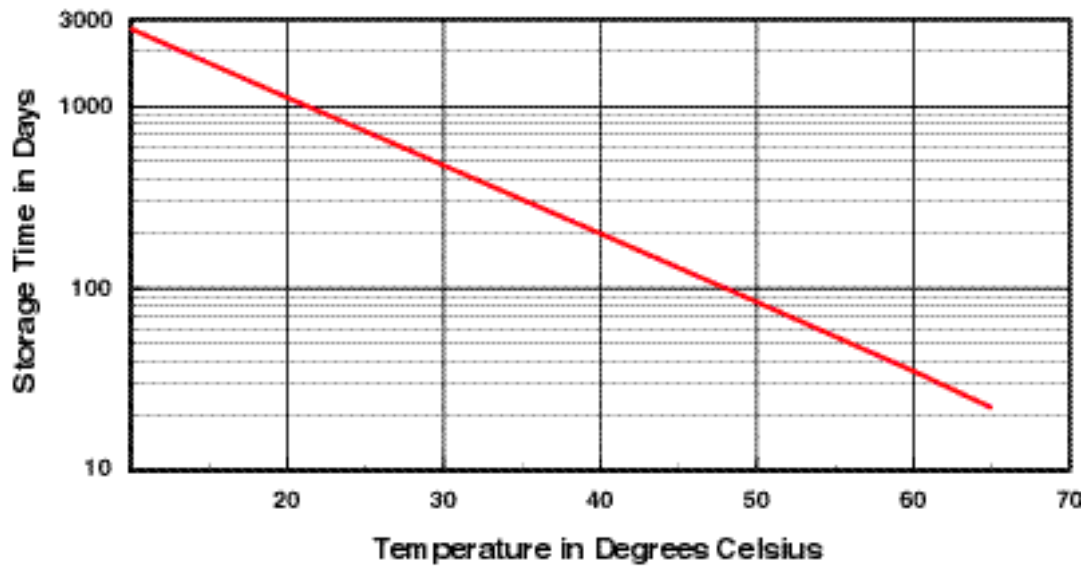

VOLTAGE REGULATION FOR CYCLON SINGLE CELLS & MONOBLOCKS

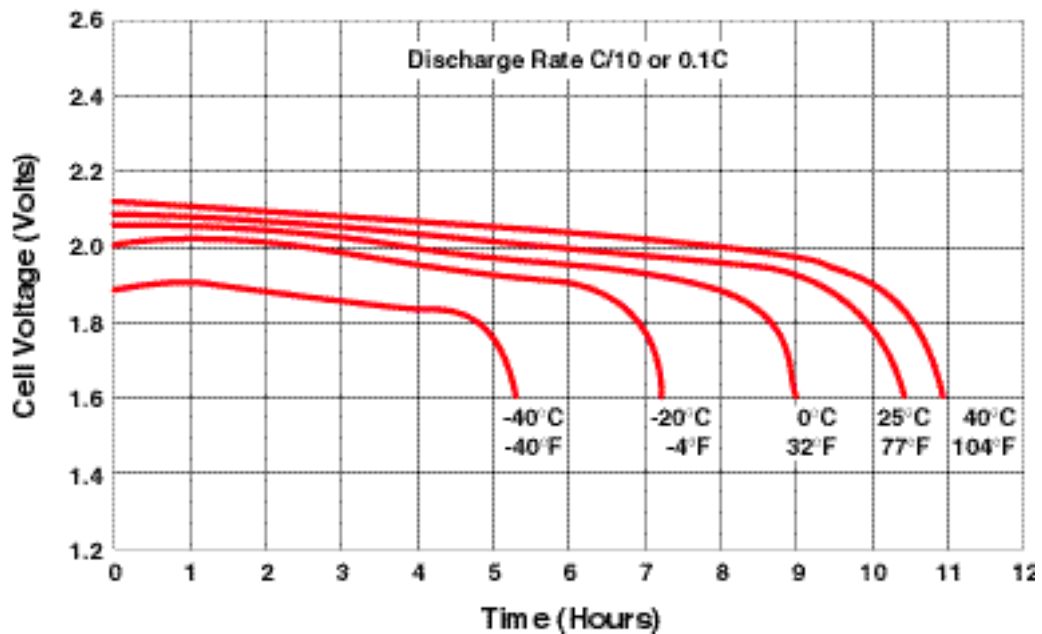

CHARGING RECOMMENDATIONS:

Broadly speaking, a battery may be recharged using either a constant voltage (CV) charger or a constant current (CC) charger, or a modification of either or both of these.

The exact regime chosen generally depends upon the time and economic constraints imposed by the system. Constant current charging is widely used in cyclic applications where a recharge must be accomplished in a relatively short time period. Constant voltage charging, where a single voltage level is applied across the battery terminals, is the most suitable method to recharge CYCLON products. Depending on the CV charger's current limit, it is possible to recharge these batteries from a 100% discharged condition to better than 95% state of charge in less than one hour, using only the cyclic charge voltage.

Constant voltage charging

Constant voltage (CV) charging should be within the following ranges:

| | |
|-----------------|---------------------------------------|
| Fast Chargers: | Per cell: 2.45 to 2.50 volts @ 25°C |
| | 12 volts: 14.70 to 15.0 volts @ 25°C |
| Float Chargers: | Per cell: 2.27 to 2.35 volts @ 25°C |
| | 12 volts: 13.62 to 14.10 volts @ 25°C |

To avoid thermal runaway in warmer temperatures, and to improve charge acceptance in colder temperatures, the charger voltage should be compensated by approximately 3 millivolts per cell per degree Centigrade variance from 25°C. This is a negative coefficient, with the voltage being lowered as the temperature increases, and vice versa.

There is no need to limit the inrush current to the battery during the initial phase of constant voltage charging. The internal resistance of EnerSys CYCLON Single Cells and Monoblocs allows for large inrush current without damage.

Since not all of the charge returned is accepted to replenish the electro-chemical potential, a good rule of thumb to use is that the charge returned should be 105% to 110% of the capacity delivered on the previous discharge.

Most current waveforms are not pure DC nor are they pure sine waves. Therefore, *consult the EnerSys Application Support Department for assistance* when evaluating the charger current waveforms for your specific application.



CYCLON PRODUCT FAMILY (All capacities at 10 hr. rate 25°C to 1.67 vpc)

CYCLON 2V single cell:

| Products (capacity) | Part Number | Internal res. of fully charged cell m @ 25°C | Nominal short circuit current for charged cell | DIMENSIONS | | | | |
|---------------------|-------------|--|--|-------------------|-----------------|--------------------------------|-----------------|-----------------------------|
| | | | | Diameter in. (mm) | Height in. (mm) | Height with terminals in. (mm) | Weight oz. (gm) | Tabs in. (mm) |
| D cell (2.5Ah) | 0810-0004 | 5.0 | 400A | 1.35 (34.3) | 2.41 (61.2) | 2.68 (68.1) | 6.28 (178.0) | .187 x .025 (4.75 x 0.64) |
| DT cell (4.5Ah) | 0860-0004 | 5.0 | 400A | 1.35 (34.3) | 3.78 (96.0) | 4.05 (102.9) | 9.68 (274.4) | .187 x .025 (4.75 x 0.64) |
| X cell (5.0Ah) | 0800-0004 | 3.5 | 570A | 1.75 (44.5) | 2.87 (72.9) | 3.21 (81.5) | 12.77 (362.0) | .250 x .025 (6.35 x 0.64) |
| E cell (8.0Ah) | 0850-0004 | 3.0 | 665A | 1.75 (44.5) | 3.94 (100.1) | 4.28 (108.7) | 17.28 (489.9) | .250 x .025 (6.35 x 0.64) |
| J cell (12.0Ah) | 0840-0004 | 2.5 | 800A | 2.04 (51.8) | 4.85 (123.2) | 5.34 (135.6) | 29.60 (839.2) | 0.312 x 0.032 (7.92 x 0.81) |
| BC cell (25Ah) | 0820-0004 | 1.5 | 1335A | 2.57 (65.3) | 6.25 (158.8) | 6.82 (173.2) | 58.88 (1669.2) | M6 (-) and M8 (+) terminals |

CYCLON 4V monobloc:

| Products (capacity) | Part Number | Internal res. of fully charged Monobloc m @ 25°C | Nominal short circuit current for charged Monobloc | DIMENSIONS | | | | |
|---------------------|-------------|--|--|-----------------|----------------|-----------------|-----------------|----------------------------|
| | | | | Length in. (mm) | Width in. (mm) | Height in. (mm) | Weight lb. (kg) | Tabs in. (mm) |
| D (2.5Ah) | 0819-0010 | 10.0 | 400A | 3.13 (79.5) | 1.81 (46.0) | 2.75 (69.9) | .80 (.36) | 0.187 x .025 (4.75 x 0.64) |
| X (5.0Ah) | 0809-0010 | 7.0 | 570A | 3.80 (96.5) | 2.12 (53.8) | 3.02 (76.7) | 1.62 (.74) | .250 x .025 (6.35 x 0.64) |
| E (8.0Ah) | 0859-0010 | 6.0 | 665A | 3.81 (96.8) | 2.13 (54.1) | 4.00 (101.6) | 2.11 (.96) | 0.250 x .025 (6.35 x 0.64) |

CYCLON 6V monobloc:

| Products (capacity) | Part Number | Internal res. of fully charged Monobloc m @ 25°C | Nominal short circuit current for charged Monobloc | DIMENSIONS | | | | |
|---------------------|-------------|--|--|-----------------|----------------|-----------------|-----------------|----------------------------|
| | | | | Length in. (mm) | Width in. (mm) | Height in. (mm) | Weight lb. (kg) | Tabs in. (mm) |
| D (2.5Ah) | 0819-0012 | 15.0 | 400A | 4.48 (113.8) | 1.81 (46.0) | 2.75 (69.9) | 1.15 (.52) | 0.187 x .025 (4.75 x 0.64) |
| X (5.0Ah) | 0809-0012 | 10.0 | 570A | 5.48 (139.2) | 2.12 (53.8) | 3.02 (76.7) | 2.16 (.98) | 0.250 x .025 (6.35 x 0.64) |
| E (8.0Ah) | 0859-0012 | 8.0 | 665A | 5.48 (139.2) | 2.13 (54.1) | 4.00 (101.6) | 3.15 (1.43) | 0.250 x .025 (6.35 x 0.64) |

All dimensions, excluding weight and tabs, are maximum

CYCLON SINGLE CELL

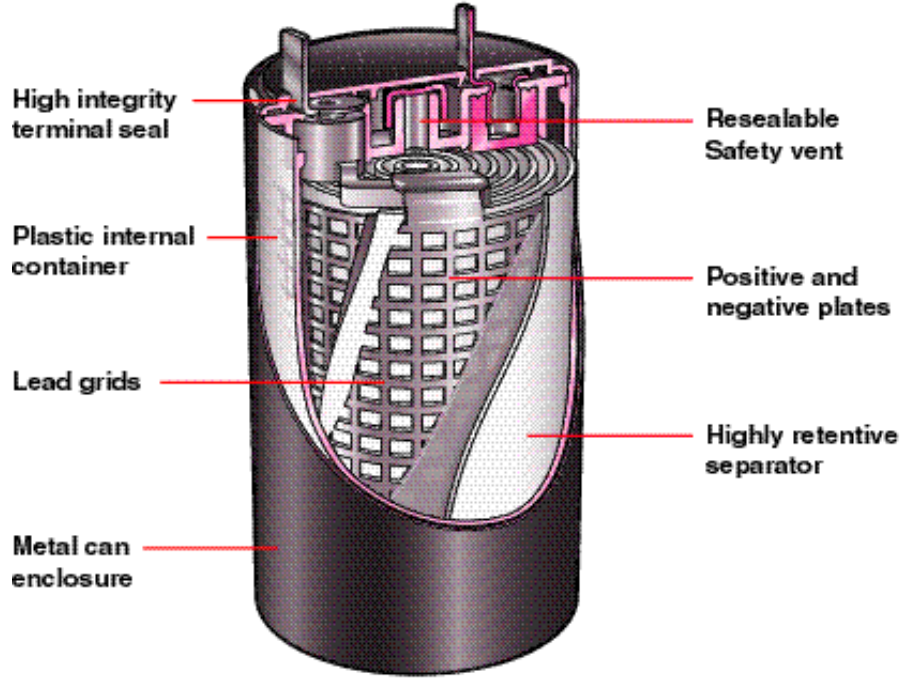

ALTERNATIVE BATTERY CONFIGURATIONS

Standard battery configurations are rectangular in overall shape. A sample of other possible configurations are illustrated below. These can be held together with tape (offering the lowest cost and minimum electrical and mechanical protection) or by shrink wrapping. The CYCLON Single Cell can be custom configured in virtually an infinite number of designs.

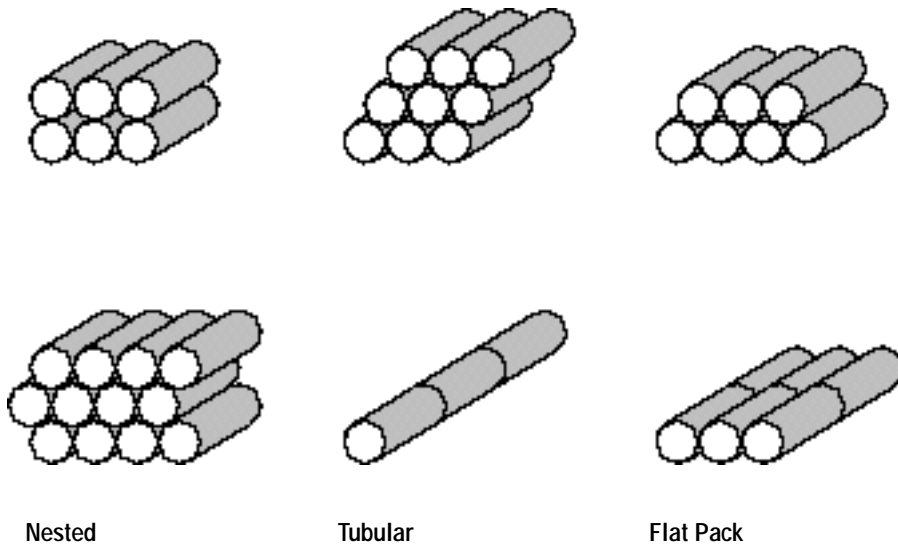



CYCLON STANDARD BATTERY DESCRIPTIONS

CYCLON cells are ideal for small ampere-hour applications up to 25Ah. The sealed-lead construction uses a starved-electrolyte system and a patented grid-alloy providing numerous advantages.

Standard batteries are offered based on combinations of the previously described CYCLON cells and are available in 6 and 12 volt configurations with capacities ranging from 2.5Ah to 25Ah.

Battery Packages

Rigid plastic cases or shrink wrap packaging are available.

Rigid Plastic

Cases are available for most designs in either flame-retardant ABS Cyclac (General Electric) material, meeting UL 94V-0 flammability rating, or Styrene (available only in 2X3 D and X battery configurations). Some cases have mounting holes. Rigid plastic cases are recommended for applications in which the battery must withstand vibration, movement or extreme weather conditions.

Shrink Wrap

Shrink wrap packaging is less expensive and smaller in size and weight. A plastic extrusion insulates the battery top and keeps the cells in line. A heavy duty shrink sleeve holds the cells firmly in place. Shrink wrap packaging is recommended for applications in which the battery remains stationary.

Battery Terminations for Single Cell and Monoblocs

Tab/Stud

| <i>Cell size</i> | <i>Dimensions</i> |
|------------------|--|
| D | .187" X .025" |
| DT | .187" X .025" |
| X | .250" X .025" |
| E | .250" X .025" |
| J | .312" X .032" |
| BC | 6mm post (negative) 8mm post (positive) |

Tab Adapters (D, DT, X, and E)

Available to convert .187" tabs to .250" tabs, 0.032" thick, and vice versa.

BC Quick Disconnect Terminals

AMP series 250 Faston terminals are available for BC batteries.

Connection Terminations

A wide variety of terminations are offered. For recommendations or to specify; contact your EnerSys Territory Manager or battery assembler.

Fusible Links

Specify your requirement.

Lead Wires

Stranded copper wire with insulation meeting UL1015 specifications (Red +, Black -). Standard leads extend 9 inches outside the battery pack. Ends are stripped and dipped in wax, which must be removed before use.

Standard wire gauges are:

| | |
|--------------|---------------|
| D batteries | 18AWG, UL1015 |
| DT batteries | 16AWG, UL1015 |
| X batteries | 16AWG, UL1015 |
| E batteries | 14AWG, UL1015 |
| J batteries | 14AWG, UL1015 |
| BC batteries | 12AWG, UL1015 |

Varying lead lengths and gauges are also available; please specify to your EnerSys Territory Manager or battery assembler.

Intercell Connections

Standard

- D, DT, X and E batteries—welded tin-plated steel connector
- J batteries—soldered, stranded wire
- BC batteries—solid copper

For vibration-prone applications

- D, DT, X, E and J batteries—soldered, stranded wire
- BC batteries—braided copper straps



CYCLON SINGLE CELL PERFORMANCE SPECIFICATIONS

Constant current discharge/amps to 1.67 vpc @ 25°C

| Products | DURATION | | | | | | | | | |
|-----------------|----------|---------|--------|---------|---------|---------|-------|-------|--------|--------|
| | 5 min. | 10 min. | 15min. | 30 min. | 60 min. | 90 min. | 5 hr. | 8 hr. | 10 hr. | 20 hr. |
| D cell (2.5Ah) | 14.8 | 8.1 | 5.9 | 3.4 | 1.9 | 1.4 | .48 | .32 | .26 | .13 |
| DT cell (4.5Ah) | 25.2 | 15.0 | 11.2 | 6.6 | 3.7 | 2.6 | .85 | .55 | .45 | .24 |
| X cell (5.0Ah) | 27.3 | 17.8 | 13.2 | 7.0 | 3.9 | 2.8 | .96 | .61 | .50 | .26 |
| E cell (8.0Ah) | 41.7 | 26.4 | 19.0 | 11.0 | 6.2 | 4.4 | 1.6 | 1.0 | .81 | .42 |
| J cell (12.0Ah) | 51.7 | 38.1 | 29.4 | 18.0 | 9.2 | 6.5 | 2.3 | 1.5 | 1.20 | .66 |

Constant power discharge/watts per cell to 1.67 vpc @ 25°C

| Products | DURATION | | | | | | | | | |
|-----------------|----------|---------|--------|---------|---------|---------|-------|-------|--------|--------|
| | 5 min. | 10 min. | 15min. | 30 min. | 60 min. | 90 min. | 5 hr. | 8 hr. | 10 hr. | 20 hr. |
| D cell (2.5Ah) | 26.4 | 16.1 | 11.6 | 6.7 | 3.8 | 2.7 | .94 | .61 | .50 | .25 |
| DT cell (4.5Ah) | 45.0 | 28.1 | 21.0 | 12.5 | 7.1 | 5.1 | 1.7 | 1.1 | .90 | .46 |
| X cell (5.0Ah) | 45.4 | 31.9 | 23.9 | 13.9 | 7.8 | 5.6 | 1.9 | 1.2 | 1.0 | .51 |
| E cell (8.0Ah) | 77.8 | 51.0 | 35.5 | 21.1 | 12.4 | 8.9 | 3.1 | 2.0 | 1.6 | .85 |
| J cell (12.0Ah) | 90.4 | 68.4 | 53.4 | 31.6 | 18.3 | 13.2 | 4.7 | 3.0 | 2.3 | 1.3 |

Charging/Temperature/Life:

| Products | CHARGING PER CELL | | TEMPERATURE RANGE | | LIFE EXPECTANCY | |
|----------------------|---------------------|---------------------|---------------------|----------------|-------------------------|---------------------------|
| | Cyclic | Float | Storage & discharge | Charge | C/5 Cycle life 100% DOD | Float life at 25°C (20°C) |
| D, DT, X, E & J cell | CV 2.45–2.50 CC* | CV 2.27–2.35 CC* | -65°C to +80°C | -40°C to +80°C | 300 | 10 years (15 years) |

Maximum recommended storage time before recharge—24 months @ 25°C or 2.0vpc, whichever is earlier

Atmospheric pressure range—Vacuum to 8 atmospheres

* Users planning to use CC should consult the EnerSys Application Support Department

UL Recognized Component. Meets UL 1989

Caution: Batteries contain toxic materials (Pb and H₂SO₄) • Avoid short circuit • Do not charge in gas-tight container
Sealed-lead rechargeable battery must be recycled or disposed of properly. Contact EnerSys Customer Service for details.



CYCLON 6 Volt 1x3 Shrink Wrap

| Product Number | Description | Length in. (mm) | Width in. (mm) | Height in. (mm) | Weight lbs. (kg) | Leads |
|----------------|--------------------|-----------------|----------------|-----------------|------------------|-------|
| 0810-0102 | 2.5Ah D Dbl. Slot | 4.05 (102.9) | 1.48 (37.6) | 2.66 (67.6) | 1.23 (.56) | No |
| 0810-0103 | 2.5Ah D | 4.05 (102.9) | 1.48 (37.6) | 2.66 (67.6) | 1.25 (.57) | Yes |
| 0860-0102 | 4.5Ah DT Dbl. Slot | 4.05 (102.9) | 1.48 (37.6) | 4.03 (102.4) | 2.07 (.94) | No |
| 0860-0103 | 4.5Ah DT | 4.05 (102.9) | 1.48 (37.6) | 4.03 (102.4) | 2.09 (.95) | Yes |
| 0800-0102 | 5.0Ah X Dbl. Slot | 5.25 (133.4) | 1.87 (47.5) | 3.12 (79.2) | 2.48 (1.13) | No |
| 0800-0103 | 5.0Ah X | 5.25 (133.4) | 1.87 (47.5) | 3.12 (79.2) | 2.52 (1.14) | Yes |
| 0850-0102 | 8.0Ah E Dbl. Slot | 5.25 (133.4) | 1.87 (47.5) | 4.19 (106.4) | 3.49 (1.58) | No |
| 0850-0103 | 8.0Ah E | 5.25 (133.4) | 1.87 (47.5) | 4.19 (106.4) | 3.53 (1.60) | Yes |



CYCLON 6 Volt 1x3 ABS Case

| Product Number | Description | Length in. (mm) | Width in. (mm) | Height in. (mm) | Weight lbs. (kg) | Leads |
|----------------|--------------------|-----------------|----------------|-----------------|------------------|-------|
| 0810-0011 | 2.5Ah D Dbl. Slot | 4.23 (107.4) | 1.55 (39.4) | 2.75 (69.9) | 1.33 (.60) | No |
| 0810-0077 | 2.5Ah D Sing. Slot | 4.23 (107.4) | 1.55 (39.4) | 2.75 (69.9) | 1.37 (.62) | Yes |
| 0800-0011 | 5.0Ah X Dbl. Slot | 5.44 (138.2) | 1.96 (49.8) | 3.16 (80.3) | 2.71 (1.23) | No |
| 0800-0071 | 5.0Ah X Sing. Slot | 5.44 (138.2) | 1.96 (49.8) | 3.16 (80.3) | 2.74 (1.24) | Yes |



CYCLON 12 Volt 2x3 Shrink Wrap

| Product Number | Description | Length in. (mm) | Width in. (mm) | Height in. (mm) | Weight lbs. (kg) | Leads |
|----------------|--------------------|-----------------|----------------|-----------------|------------------|-------|
| 0810-0114 | 2.5Ah D Dbl. Slot | 4.05 (102.9) | 2.82 (71.6) | 2.67 (67.8) | 2.48 (1.13) | No |
| 0810-0115 | 2.5Ah D | 4.05 (102.9) | 2.82 (71.6) | 2.67 (67.8) | 2.50 (1.14) | Yes |
| 0860-0114 | 4.5Ah DT Dbl. Slot | 4.05 (102.9) | 2.82 (71.6) | 4.03 (102.4) | 3.88 (1.76) | No |
| 0860-0115 | 4.5Ah DT | 4.05 (102.9) | 2.82 (71.6) | 4.03 (102.4) | 3.91 (1.77) | Yes |
| 0800-0114 | 5.0Ah X Dbl. Slot | 5.25 (133.4) | 3.68 (93.5) | 3.13 (79.5) | 4.93 (2.24) | No |
| 0800-0115 | 5.0Ah X | 5.25 (133.4) | 3.68 (93.5) | 3.13 (79.5) | 4.97 (2.26) | Yes |
| 0850-0114 | 8.0Ah E Dbl. Slot | 5.25 (133.4) | 3.68 (93.5) | 4.19 (106.4) | 6.73 (3.05) | No |
| 0850-0115 | 8.0Ah E | 5.25 (133.4) | 3.68 (93.5) | 4.19 (106.4) | 6.77 (3.07) | Yes |



CYCLON 12 Volt 2x3 ABS and Styrene Cases

| Product Number | Description | Length in. (mm) | Width in. (mm) | Height in. (mm) | Weight lbs. (kg) | Leads |
|----------------|-------------------|-----------------|----------------|-----------------|------------------|-------|
| 0810-0008 | 2.5Ah D Dbl. Slot | 4.23 (107.4) | 2.88 (73.2) | 2.72 (69.1) | 2.68 (1.22) | No |
| 0810-0067* | 2.5Ah D (Styrene) | 4.23 (107.4) | 2.97 (75.4) | 2.73 (69.3) | 2.63 (1.19) | Yes |
| 0800-0008 | 5.0Ah X Dbl. Slot | 5.44 (138.2) | 3.70 (94.0) | 3.14 (79.8) | 5.34 (2.42) | No |
| 0800-0047* | 5.0Ah X (Styrene) | 5.44 (138.2) | 3.70 (94.0) | 3.19 (81.0) | 5.22 (2.37) | Yes |



CYCLON 12 Volt 1x6 Shrink Wrap

| Product Number | Description | Length in. (mm) | Width in. (mm) | Height in. (mm) | Weight lbs. (kg) | Leads |
|----------------|--------------------|-----------------|----------------|-----------------|------------------|-------|
| 0810-0108 | 2.5Ah D Dbl. Slot | 8.08 (205.2) | 1.48 (37.6) | 2.66 (67.6) | 2.49 (1.13) | No |
| 0810-0109 | 2.5Ah D | 8.08 (205.2) | 1.48 (37.6) | 2.66 (67.6) | 2.52 (1.14) | Yes |
| 0860-0108 | 4.5Ah DT Dbl. Slot | 8.08 (205.2) | 1.48 (37.6) | 4.03 (102.4) | 3.88 (1.76) | No |
| 0860-0109 | 4.5Ah DT | 8.08 (205.2) | 1.48 (37.6) | 4.03 (102.4) | 3.91 (1.77) | Yes |
| 0800-0108 | 5.0Ah X Dbl. Slot | 10.48 (266.2) | 1.87 (47.5) | 3.12 (79.2) | 4.99 (2.27) | No |
| 0800-0109 | 5.0Ah X | 10.48 (266.2) | 1.87 (47.5) | 3.12 (79.2) | 5.03 (2.28) | Yes |
| 0850-0108 | 8.0Ah E Dbl. Slot | 10.48 (266.2) | 1.87 (47.5) | 4.19 (106.4) | 6.73 (3.05) | No |
| 0850-0109 | 8.0Ah E | 10.48 (266.2) | 1.87 (47.5) | 4.19 (106.4) | 6.77 (3.07) | Yes |



CYCLON 12 Volt 1x6 ABS Case

| Product Number | Description | Length in. (mm) | Width in. (mm) | Height in. (mm) | Weight lbs. (kg) | Leads |
|----------------|--------------------|-----------------|----------------|-----------------|------------------|-------|
| 0810-0016 | 2.5Ah D Dbl. Slot | 8.25 (209.6) | 1.55 (39.4) | 2.74 (69.6) | 2.74 (1.24) | No |
| 0810-0075 | 2.5Ah D Sing. Slot | 8.25 (209.6) | 1.55 (39.4) | 2.74 (69.6) | 2.76 (1.25) | Yes |
| 0800-0016 | 5.0Ah X Dbl. Slot | 10.66 (270.8) | 1.96 (49.8) | 3.15 (80.0) | 5.20 (2.36) | No |
| 0800-0072 | 5.0Ah X Sing. Slot | 10.66 (270.8) | 1.96 (49.8) | 3.15 (80.0) | 5.24 (2.38) | Yes |

All dimensions, excluding weight, are maximum

*Consult EnerSys Customer Service Department for availability; due to special assembly

Constant current discharge/amps to 1.67 vpc @ 25°C

| Products | DURATION | | | | | | | | | |
|----------------|----------|---------|--------|---------|---------|---------|-------|-------|--------|--------|
| | 5 min. | 10 min. | 15min. | 30 min. | 60 min. | 90 min. | 5 hr. | 8 hr. | 10 hr. | 20 hr. |
| BC cell (25Ah) | 118.3 | 72.8 | 54.3 | 32.2 | 19.3 | 14.0 | 4.85 | 3.14 | 2.55 | 1.33 |

Constant power discharge/watts per cell to 1.67 vpc @ 25°C

| Products | DURATION | | | | | | | | | |
|----------------|----------|---------|--------|---------|---------|---------|-------|-------|--------|--------|
| | 5 min. | 10 min. | 15min. | 30 min. | 60 min. | 90 min. | 5 hr. | 8 hr. | 10 hr. | 20 hr. |
| BC cell (25Ah) | 197.3 | 142.4 | 105.5 | 63.5 | 36.8 | 25.6 | 9.20 | 6.04 | 4.95 | 2.60 |

Charging/Temperature/Life:

| Products | CHARGING PER CELL | | TEMPERATURE RANGE | | LIFE EXPECTANCY | |
|----------------|---------------------|---------------------|---------------------|----------------|-------------------------|---------------------------|
| | Cyclic | Float | Storage & discharge | Charge | C/5 Cycle life 100% DOD | Float life at 25°C (20°C) |
| BC cell (25Ah) | CV 2.45–2.50 CC* | CV 2.27–2.35 CC* | -65°C to +80°C | -40°C to +80°C | 300 | 10 years (15 years) |

Maximum recommended storage time before recharge—24 months @ 25°C or 2.0vpc, whichever is earlier

Atmospheric pressure range—Vacuum to 8 atmospheres

Mounting—Terminal torque must not exceed 35 in.-lbs. (3.95 nm)

* Users planning to use CC should consult the EnerSys Application Support Department



CYCLON 12 Volt 2x3 25.0Ah Case

| Product Number | Description | Length in. (mm) | Width in. (mm) | Height in. (mm) | Weight lbs. (kg) | Leads |
|----------------|-------------------------------|-----------------|----------------|-----------------|------------------|-------|
| 0820-0020 | BC Double Slot, Copper Straps | 8.05 (204.5) | 5.45 (138.4) | 7.25 (184.2) | 22.86 (10.4) | No |

All dimensions, excluding weight, are maximum

UL Recognized Component. Meets UL 1989

Caution: Batteries contain toxic materials (Pb and H₂SO₄) • Avoid short circuit • Do not charge in gas-tight container
Sealed-lead rechargeable battery must be recycled or disposed of properly. Contact EnerSys Customer Service for details.

CYCLON SINGLE CELL MECHANICAL SPECIFICATIONS (E, G, H & J — MAXIMUM)

| Products | DIMENSIONS in. (mm) | | | | | | | | | | Weight oz. (gm) |
|----------|---------------------|----------------|-----------------|-----|----------------|-----------------|-----------------|---------------|---------------|----------------|------------------|
| | A | B | C | D | E | F | G | H | I | J | |
| D cell | 0.27 (6.9) | 0.51 (13.0) | .187 (4.75) | 22° | 0.27 (6.9) | 0.025 (0.64) | 2.41 (61.2) | 0.05 (1.3) | 0.13 (3.3) | 1.35 (34.3) | 6.28 (178.0) |
| DT cell | 0.27 (6.9) | 0.51 (13.0) | .187 (4.75) | 22° | 0.27 (6.9) | 0.025 (0.64) | 3.78 (96.0) | 0.05 (1.3) | 0.13 (3.3) | 1.35 (34.3) | 9.68 (274.4) |
| X cell | 0.29 (7.4) | 0.61 (15.5) | 0.250 (6.35) | 22° | 0.34 (8.6) | 0.025 (0.64) | 2.87 (72.9) | 0.06 (1.5) | 0.14 (3.6) | 1.75 (44.5) | 12.77 (362.0) |
| E cell | 0.29 (7.4) | 0.61 (15.5) | 0.250 (6.35) | 22° | 0.34 (8.6) | 0.025 (0.64) | 3.94 (100.1) | 0.06 (1.5) | 0.14 (3.6) | 1.75 (44.5) | 17.28 (489.9) |
| J cell | 0.32 (8.1) | 0.74 (18.8) | 0.312 (7.92) | 22° | 0.49 (12.4) | 0.032 (0.81) | 4.85 (123.2) | 0.05 (1.3) | 0.15 (3.8) | 2.04 (51.8) | 29.60 (839.2) |

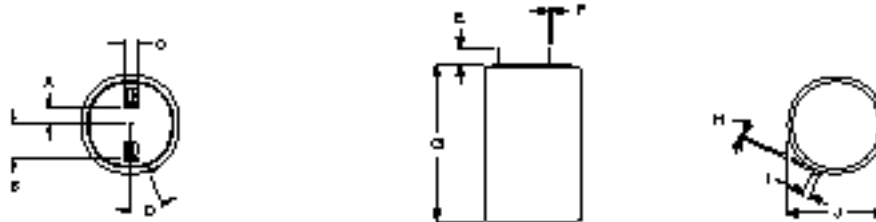

CYCLON BC SINGLE CELL MECHANICAL SPECIFICATIONS (F, G & I — MAXIMUM)

| Products | DIMENSIONS in. (mm) | | | | | | | | | Weight lb. (kg) |
|----------|---------------------|----------------|-----|----------------|---------------|-----------------|---------------|---------------|----------------|-----------------|
| | A | B | C | D | E | F | G | H | I | |
| BC cell | 0.65 (16.5) | 1.30 (33.0) | 22° | 0.57 (14.5) | 0.22 (5.6) | 6.25 (158.8) | 0.06 (1.5) | 0.13 (3.3) | 2.57 (65.3) | 3.68 (1.67) |

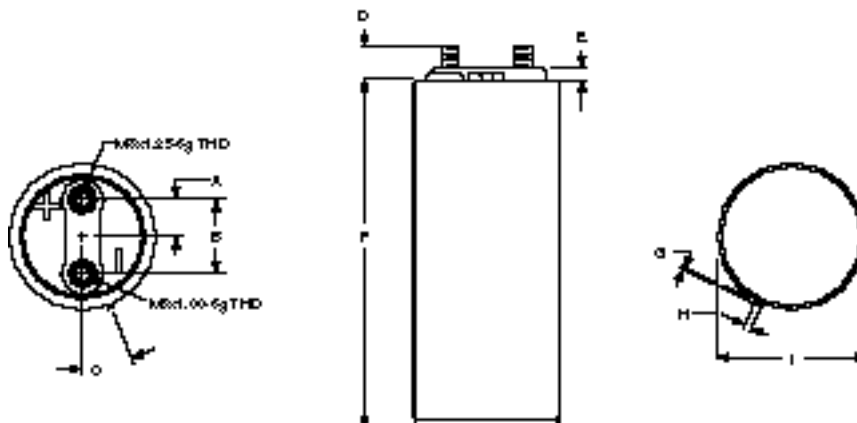

CYCLON SINGLE CELL CONSTANT CURRENT (CC) DISCHARGE

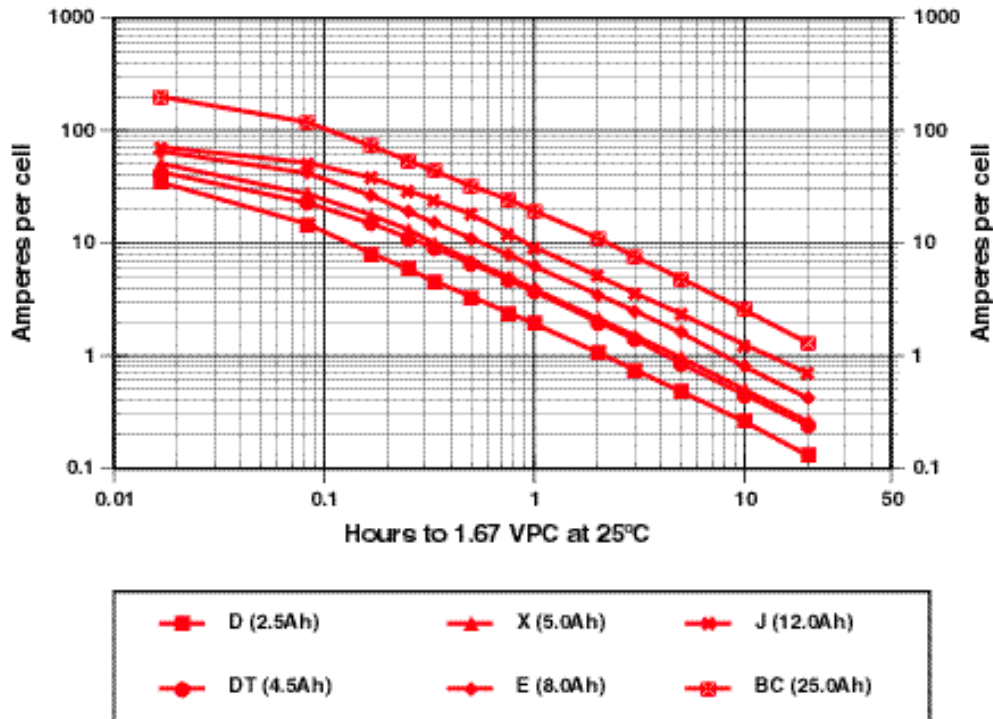

CYCLON SINGLE CELL CONSTANT POWER (CP) DISCHARGE

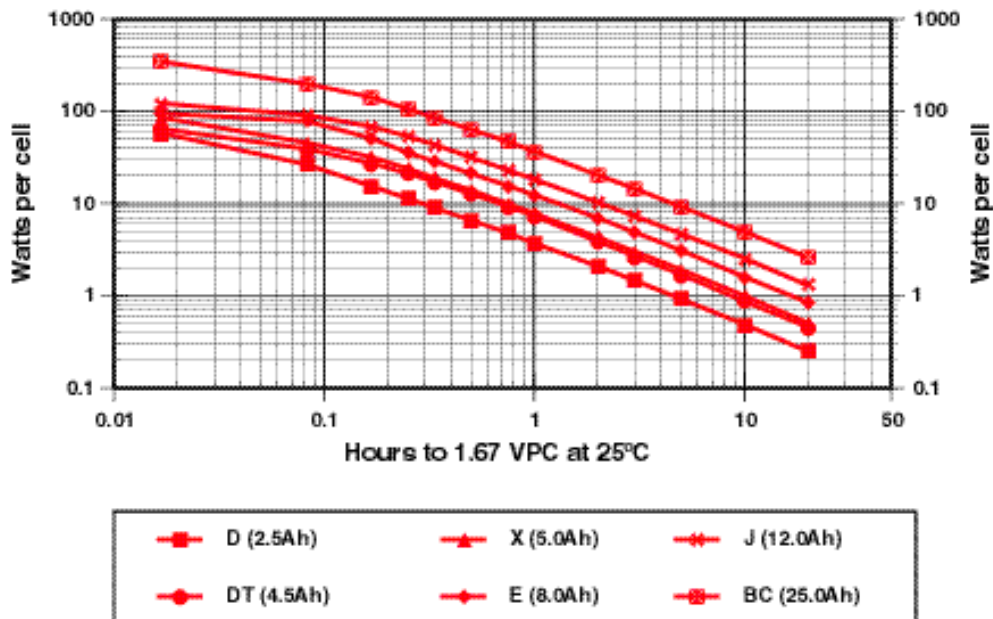



4V & 6V Constant current discharge/amps to 1.67 vpc @ 25°C:

| Products | DURATION | | | | | | | | | |
|-----------|----------|---------|--------|---------|---------|---------|-------|-------|--------|--------|
| | 5 min. | 10 min. | 15min. | 30 min. | 60 min. | 90 min. | 5 hr. | 8 hr. | 10 hr. | 20 hr. |
| D (2.5Ah) | 14.3 | 8.1 | 5.9 | 3.4 | 1.9 | 1.4 | .48 | .32 | .26 | .13 |
| X (5.0Ah) | 28.9 | 18.1 | 13.5 | 7.1 | 4.0 | 2.8 | 1.0 | .61 | .52 | .26 |
| E (8.0Ah) | 41.7 | 26.4 | 19.0 | 11.0 | 6.2 | 4.4 | 1.6 | 1.0 | .81 | .42 |

4V & 6V Constant power discharge/watts per cell to 1.67 vpc @ 25°C:

| Products | DURATION | | | | | | | | | |
|-----------|----------|---------|--------|---------|---------|---------|-------|-------|--------|--------|
| | 5 min. | 10 min. | 15min. | 30 min. | 60 min. | 90 min. | 5 hr. | 8 hr. | 10 hr. | 20 hr. |
| D (2.5Ah) | 25.3 | 15.9 | 11.7 | 6.8 | 3.8 | 2.7 | .93 | .60 | .49 | .25 |
| X (5.0Ah) | 48.8 | 32.3 | 24.2 | 13.8 | 7.8 | 5.6 | 2.0 | 1.2 | 1.0 | .52 |
| E (8.0Ah) | 77.8 | 51.0 | 35.5 | 21.1 | 12.4 | 8.9 | 3.1 | 2.0 | 1.7 | .85 |

Charging/Temperature/Life:

| Products | CHARGING PER BATTERY | | TEMPERATURE RANGE | | LIFE EXPECTANCY | |
|-----------------------|----------------------|---------------------|-----------------------------|------------------------------|-------------------------|--------------------------------|
| | Cyclic | Float | Storage, discharge & charge | Safety pressure relief valve | C/5 Cycle life 100% DOD | Float life at 25°C (20°C) |
| 4V D, X, & E Monobloc | CV 4.90–5.00 CC* | CV 4.54–4.70 CC* | -40°C to +40°C | 8 psi | 300 | Up to 8 yrs. (Up to 8 yrs.) |
| 6V D, X, & E Monobloc | CV 7.35–7.50 CC* | CV 6.81–7.05 CC* | -40°C to +40°C | 8 psi | 300 | Up to 8 yrs. (Up to 8 yrs.) |

* Users planning to use CC should consult the EnerSys Application Support Department

Maximum recommended storage time before recharge—24 months @ 25°C or 2.0vpc, whichever is earlier

Atmospheric pressure range—Vacuum to 2 atmospheres

Mounting—Each monobloc is equipped with mounting holes in the cover. The tightening torque for mounting the monobloc is 25 in.-lbs. When using 4 mounting bolts, small spacers (washers) 1 to 3 mm thick should be placed between the battery and the mounting surface to prevent bowing or stressing the battery case.

UL Recognized Component. Meets UL 1989

Caution: Batteries contain toxic materials (Pb and H₂SO₄) • Avoid short circuit • Do not charge in gas-tight container
Sealed-lead rechargeable battery must be recycled or disposed of properly. Contact EnerSys Customer Service for details.



CYCLON 4 Volt Monoblocs

| Product Number | Description | Length in. (mm) | Width in. (mm) | Height in. (mm) | Weight lbs. (kg) |
|----------------|--------------------|-----------------|----------------|-----------------|------------------|
| 0819-0010 | 4V, 2.5Ah Monobloc | 3.13 (79.5) | 1.81 (46.0) | 2.75 (69.9) | .80 (.36) |
| 0809-0010 | 4V, 5.0Ah Monobloc | 3.80 (96.5) | 2.12 (53.8) | 3.02 (76.7) | 1.62 (.74) |
| 0859-0010 | 4V, 8.0Ah Monobloc | 3.81 (96.8) | 2.13 (54.1) | 4.00 (101.6) | 2.11 (.96) |



CYCLON 6 Volt Monoblocs

| Product Number | Description | Length in. (mm) | Width in. (mm) | Height in. (mm) | Weight lbs. (kg) |
|----------------|--------------------|-----------------|----------------|-----------------|------------------|
| 0819-0012 | 6V, 2.5Ah Monobloc | 4.48 (113.8) | 1.81 (46.0) | 2.75 (69.9) | 1.15 (.52) |
| 0809-0012 | 6V, 5.0Ah Monobloc | 5.48 (139.2) | 2.12 (53.8) | 3.02 (76.7) | 2.16 (.98) |
| 0859-0012 | 6V, 8.0Ah Monobloc | 5.48 (139.2) | 2.13 (54.1) | 4.00 (101.6) | 3.15 (1.43) |



CYCLON 12 Volt 2x3 Monoblocs

| Product Number | Description | Length in. (mm) | Width in. (mm) | Height in. (mm) | Weight lbs. (kg) |
|----------------|-----------------|-----------------|----------------|-----------------|------------------|
| 0819-0020 | 12V, 2.5Ah, 2x3 | 4.48 (113.8) | 3.52 (89.4) | 2.77 (70.4) | 2.30 (1.04) |
| 0809-0020 | 12V, 5.0Ah, 2x3 | 5.48 (139.2) | 4.18 (106.2) | 3.04 (77.2) | 4.32 (1.96) |
| 0859-0020 | 12V, 8.0Ah, 2x3 | 5.48 (139.2) | 4.18 (106.2) | 4.02 (102.1) | 6.30 (2.86) |



CYCLON 12 Volt 1x6 Monoblocs

| Product Number | Description | Length in. (mm) | Width in. (mm) | Height in. (mm) | Weight lbs. (kg) |
|----------------|-----------------|-----------------|----------------|-----------------|------------------|
| 0819-0016 | 12V, 2.5Ah, 1x6 | 8.84 (224.5) | 1.81 (46.0) | 2.77 (70.4) | 2.30 (1.04) |
| 0809-0016 | 12V, 5.0Ah, 1x6 | 10.88(276.4) | 2.12 (53.8) | 3.04 (77.2) | 4.32 (1.96) |
| 0859-0016 | 12V, 8.0Ah, 1x6 | 10.88(276.4) | 2.13 (54.1) | 4.02 (102.1) | 6.30 (2.86) |

All dimensions, excluding weight, are maximum

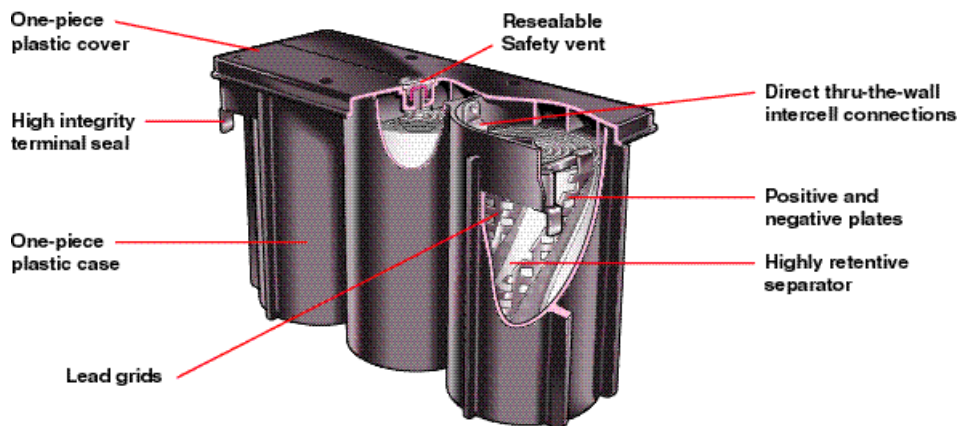



CYCLON 4V MONOBLOC MECHANICAL SPECIFICATIONS (A, B & C — MAXIMUM)

| Products | DIMENSIONS in. (mm) | | | | | Weight lb. (kg) | Tabs |
|------------|---------------------|----------------|----------------|---------------|----------------|--------------------|--|
| | A | B | C | D | E | | |
| D Monobloc | 2.75 (69.9) | 3.13 (79.5) | 1.81 (46.0) | .61 (15.5) | 1.23 (31.2) | .80 (.36) | 0.187 in. x 0.025 in. (4.75 mm x 0.64 mm) |
| X Monobloc | 3.02 (76.7) | 3.80 (96.5) | 2.12 (53.8) | .73 (18.5) | 1.45 (36.8) | 1.62 (.74) | 0.250 in. x 0.025 in. (6.35 mm x 0.64 mm) |
| E Monobloc | 4.00 (101.6) | 3.81 (96.8) | 2.13 (54.1) | .73 (18.5) | 1.45 (36.8) | 2.11 (.96) | 0.250 in. x 0.025 in. (6.35 mm x 0.64 mm) |

CYCLON 6V MONOBLOC MECHANICAL SPECIFICATIONS (A, B & C — MAXIMUM)

| Products | DIMENSIONS in. (mm) | | | | | | | Weight lb. (kg) | Tabs |
|------------|---------------------|-----------------|----------------|---------------|----------------|----------------|---------------|--------------------|--|
| | A | B | C | D | E | F | G | | |
| D Monobloc | 2.75 (69.9) | 4.48 (113.8) | 1.81 (46.0) | .61 (15.5) | 1.23 (31.2) | 1.33 (33.8) | .67 (17.0) | 1.15 (.52) | 0.187 in. x 0.025 in. (4.75 mm x 0.64 mm) |
| X Monobloc | 3.02 (76.7) | 5.48 (139.2) | 2.12 (53.8) | .73 (18.5) | 1.45 (36.8) | 1.71 (43.4) | .86 (21.8) | 2.12 (.98) | 0.250 in. x 0.025 in. (6.35 mm x 0.64 mm) |
| E Monobloc | 4.00 (101.6) | 5.48 (139.2) | 2.13 (54.1) | .73 (18.5) | 1.45 (36.8) | 1.71 (43.4) | .86 (21.8) | 3.15 (1.43) | 0.250 in. x 0.025 in. (6.35 mm x 0.64 mm) |

D Monobloc

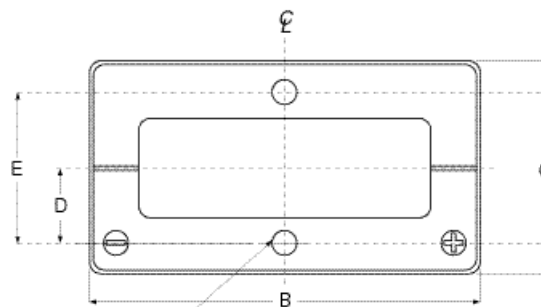
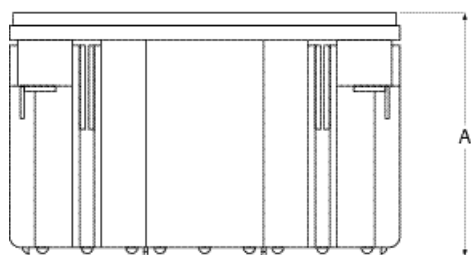

4V top

X & E Monobloc

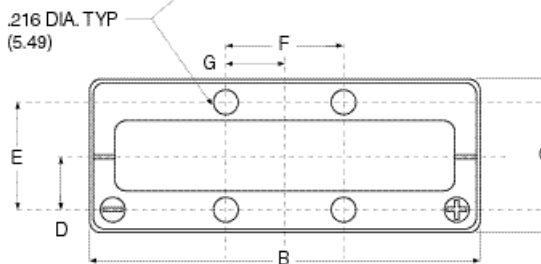
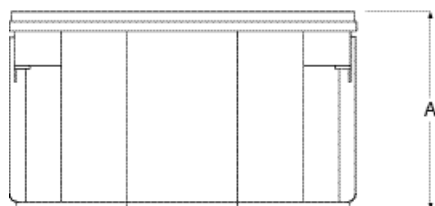

6V top

4V/6V MONOBLOC CONSTANT CURRENT (CC) CURVES TO 1.67 VPC

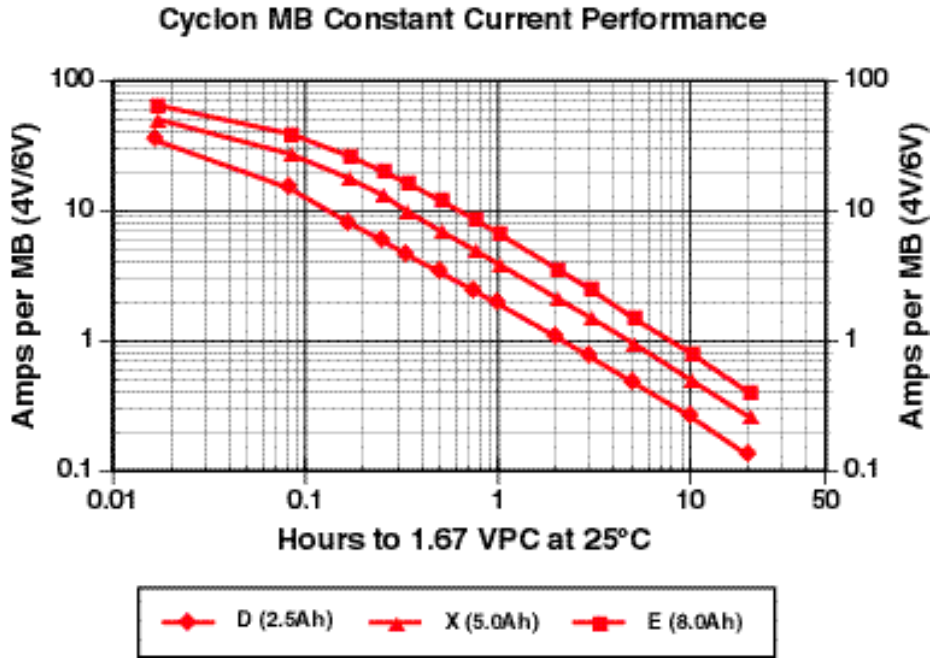

4V/6V MONOBLOC CONSTANT POWER (CP) CURVES TO 1.67 VPC

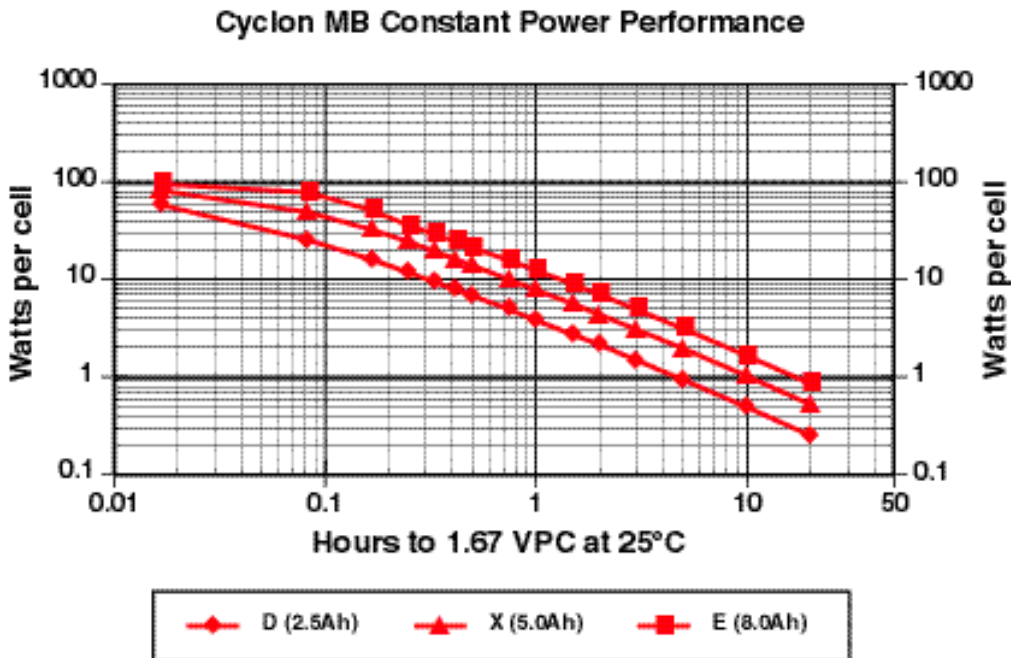



ENERSYS STANDARD PRODUCT LIST

SINGLE CELL (sc)

| PART NUMBER | DESCRIPTION | VOLTAGE | 10 Hr RATE | PERFORMANCE SPECIFICATIONS | MECHANICAL SPECIFICATIONS |
|-------------|-----------------------|---------|------------|----------------------------|---------------------------|
| 0810-0004 | D Single Cell (Dsc) | 2V | 2.5Ah | page 12 | page 15 |
| 0860-0004 | DT Single Cell (DTsc) | 2V | 4.5Ah | page 12 | page 15 |
| 0800-0004 | X Single Cell (Xsc) | 2V | 5.0Ah | page 12 | page 15 |
| 0850-0004 | E Single Cell (Esc) | 2V | 8.0Ah | page 12 | page 15 |
| 0840-0004 | J Single Cell (Jsc) | 2V | 12.0Ah | page 12 | page 15 |
| 0820-0004 | BC Single Cell (BCsc) | 2V | 25.0Ah | page 14 | page 15 |

SINGLE CELL STANDARD BATTERY DESIGNS

| PART NUMBER | DESCRIPTION | VOLTAGE | 10 Hr RATE | PERFORMANCE SPECIFICATIONS | MECHANICAL SPECIFICATIONS |
|-------------|---------------------------------------|---------|------------|----------------------------|---------------------------|
| 0810-0102 | 1x3 Dsc, double slot, shrink wrap | 6V | 2.5Ah | page 12 | page 13 |
| 0810-0103 | 1x3 Dsc, shrink wrap, leads | 6V | 2.5Ah | page 12 | page 13 |
| 0810-0011 | 1x3 Dsc, double slot, ABS case | 6V | 2.5Ah | page 12 | page 13 |
| 0810-0077 | 1x3 Dsc, single slot, ABS case, leads | 6V | 2.5Ah | page 12 | page 13 |
| 0860-0102 | 1x3 DTsc, double slot, shrink wrap | 6V | 4.5Ah | page 12 | page 13 |
| 0860-0103 | 1x3 DTsc, shrink wrap, leads | 6V | 4.5Ah | page 12 | page 13 |
| 0800-0102 | 1x3 Xsc, double slot, shrink wrap | 6V | 5.0Ah | page 12 | page 13 |
| 0800-0103 | 1x3 Xsc, shrink wrap, leads | 6V | 5.0Ah | page 12 | page 13 |
| 0800-0011 | 1x3 Xsc, double slot, ABS case | 6V | 5.0Ah | page 12 | page 13 |
| 0800-0071 | 1x3 Xsc, single slot, ABS case, leads | 6V | 5.0Ah | page 12 | page 13 |
| 0850-0102 | 1x3 Esc, double slot, shrink wrap | 6V | 8.0Ah | page 12 | page 13 |
| 0850-0103 | 1x3 Esc, shrink wrap, leads | 6V | 8.0Ah | page 12 | page 13 |
| 0810-0108 | 1x6 Dsc, double slot, shrink wrap | 12V | 2.5Ah | page 12 | page 13 |
| 0810-0109 | 1x6 Dsc, shrink wrap, leads | 12V | 2.5Ah | page 12 | page 13 |
| 0810-0016 | 1x6 Dsc, double slot, ABS case | 12V | 2.5Ah | page 12 | page 13 |
| 0810-0075 | 1x6 Dsc, single slot, ABS case, leads | 12V | 2.5Ah | page 12 | page 13 |
| 0810-0114 | 2x3 Dsc, double slot, shrink wrap | 12V | 2.5Ah | page 12 | page 13 |
| 0810-0115 | 2x3 Dsc, shrink wrap, leads | 12V | 2.5Ah | page 12 | page 13 |
| 0810-0008 | 2x3 Dsc, double slot, ABS case | 12V | 2.5Ah | page 12 | page 13 |
| 0810-0067* | 2x3 Dsc, Styrene case, leads | 12V | 2.5Ah | page 12 | page 13 |
| 0860-0108 | 1x6 DTsc, double slot, shrink wrap | 12V | 4.5Ah | page 12 | page 13 |
| 0860-0109 | 1x6 DTsc, shrink wrap, leads | 12V | 4.5Ah | page 12 | page 13 |
| 0860-0114 | 2x3 DTsc, double slot, shrink wrap | 12V | 4.5Ah | page 12 | page 13 |
| 0860-0115 | 2x3 DTsc, shrink wrap, leads | 12V | 4.5Ah | page 12 | page 13 |
| 0800-0108 | 1x6 Xsc, double slot, shrink wrap | 12V | 5.0Ah | page 12 | page 13 |
| 0800-0109 | 1x6 Xsc, shrink wrap, leads | 12V | 5.0Ah | page 12 | page 13 |
| 0800-0016 | 1x6 Xsc, double slot, ABS case | 12V | 5.0Ah | page 12 | page 13 |
| 0800-0072 | 1x6 Xsc, single slot, ABS case, leads | 12V | 5.0Ah | page 12 | page 13 |
| 0800-0114 | 2x3 Xsc, double slot, shrink wrap | 12V | 5.0Ah | page 12 | page 13 |
| 0800-0115 | 2x3 Xsc, shrink wrap, leads | 12V | 5.0Ah | page 12 | page 13 |
| 0800-0008 | 2x3 Xsc, double slot, ABS case | 12V | 5.0Ah | page 12 | page 13 |
| 0800-0047* | 2x3 Xsc, Styrene case, leads | 12V | 5.0Ah | page 12 | page 13 |
| 0850-0108 | 1x6 Esc, double slot, shrink wrap | 12V | 8.0Ah | page 12 | page 13 |
| 0850-0109 | 1x6 Esc, shrink wrap, leads | 12V | 8.0Ah | page 12 | page 13 |
| 0850-0114 | 2x3 Esc, double slot, shrink wrap | 12V | 8.0Ah | page 12 | page 13 |
| 0850-0115 | 2x3 Esc, shrink wrap, leads | 12V | 8.0Ah | page 12 | page 13 |
| 0820-0020 | 2x3 BCsc, double slot, copper strap | 12V | 25.0Ah | page 14 | page 14 |

MONOBLOC (mb)

| PART NUMBER | DESCRIPTION | VOLTAGE | 10 Hr RATE | PERFORMANCE SPECIFICATIONS | MECHANICAL SPECIFICATIONS |
|-------------|------------------|---------|------------|----------------------------|---------------------------|
| 0819-0010 | D Monobloc (Dmb) | 4V | 2.5Ah | page 17 | page 19 |
| 0809-0010 | X Monobloc (Xmb) | 4V | 5.0Ah | page 17 | page 19 |
| 0859-0010 | E Monobloc (Emb) | 4V | 8.0Ah | page 17 | page 19 |
| 0819-0012 | D Monobloc (Dmb) | 6V | 2.5Ah | page 17 | page 19 |
| 0809-0012 | X Monobloc (Xmb) | 6V | 5.0Ah | page 17 | page 19 |
| 0859-0012 | E Monobloc (Emb) | 6V | 8.0Ah | page 17 | page 19 |

MONOBLOC STANDARD BATTERY DESIGNS

| PART NUMBER | DESCRIPTION | VOLTAGE | 10 Hr RATE | PERFORMANCE SPECIFICATIONS | MECHANICAL SPECIFICATIONS |
|-------------|-------------|---------|------------|----------------------------|---------------------------|
| 0819-0016 | 1x6 Dmb | 12V | 2.5Ah | page 17 | page 18 |
| 0819-0020 | 2x3 Dmb | 12V | 2.5Ah | page 17 | page 18 |
| 0809-0016 | 1x6 Xmb | 12V | 5.0Ah | page 17 | page 18 |
| 0809-0020 | 2x3 Xmb | 12V | 5.0Ah | page 17 | page 18 |
| 0859-0016 | 1x6 Emb | 12V | 8.0Ah | page 17 | page 18 |
| 0859-0020 | 2x3 Emb | 12V | 8.0Ah | page 17 | page 18 |

CAPACITY RATINGS BASED ON END OF DISCHARGE VOLTAGE OF 1.67 VOLTS/CELL AT 25°C

*Consult EnerSys Customer Service Department for availability; due to special assembly



POWER
TECHNOLOGIES



www.enersysinc.com

Global Headquarters
P.O. Box 14145 Reading,
PA 196212-4145
USA
Tel: +1-610-208-1991
+1-800-538-3627
Fax: +1-610-372-8613

EnerSys EMEA
Brussels, Belgium
Tel: +32 (0)2 247 94 47

EnerSys Asia
Guangdong, China
Tel: +86-755-2689 3639

Distributed by: