



Part no.: 50138063
ODS110L1.3/LCT-M12
Optical distance sensor



 IO-Link



Figure can vary

Contents

- Technical data
- Dimensioned drawings
- Electrical connection
- Diagrams
- Operation and display
- Part number code
- Notes
- Accessories

Technical data

Basic data	
Series	110
Application	Collision protection for transport vehicles Fill-level monitoring Length measurement in material cutting
Type of scanning system	Against object
Optical data	
Beam profile	Collimated
Light source	Laser , Red
Laser light wavelength	655 nm
Laser class	1 , IEC/EN 60825-1:2007
Transmitted-signal shape	Pulsed
Light spot size [at sensor distance]	5.5 mm x 7 mm [5,000 mm]
Type of light spot geometry	Oval
Measurement data	
Measurement range (6 ... 90 % diffuse reflection)	100 ... 3,000 mm
Measurement range (90 % diffuse reflection)	100 ... 5,000 mm
Resolution	1.0 ... 5.0 mm
Reproducibility (1 sigma)	, see diagram
Temperature drift	2 mm/K
Standard measurement object	50 x 50 mm ²
Optical distance measurement principle	Time of flight
Linearity error	30 mm
Electrical data	
Protective circuit	Polarity reversal protection Short circuit protected
Performance data	
Supply voltage U _B	18 ... 30 V , DC
Open-circuit current	60 mA
Inputs	
Number of teach inputs	1 Piece(s)
Teach inputs	
Voltage type	DC
Switching voltage	high: +U _B
Teach input 1	
Assignment	Connection 1, pin 5

Outputs

Number of analog outputs	1 Piece(s)
Number of digital switching outputs	1 Piece(s)
IO-Link note	Two switching outputs via IO-Link process data (SSC 1 & SSC 2)

Analog outputs
Analog output 1

Type	Current
Assignment	Connection 1, pin 2

Switching outputs

Voltage type	DC
--------------	----

Switching output 1

Assignment	Connection 1, pin 4
Switching element	Transistor , Push-pull
Switching principle	IO-Link / light switching (PNP)/dark switching (NPN)

Timing

Response time	4 ms , Axial object approach / 20 ms, lateral object entry
---------------	--

Interface

Type	IO-Link
------	---------

IO-Link

COM mode	COM2
Profile	Common Profile
Frame type	2.2
Port type	A
Specification	V1.1
Device ID	0x00087E
SIO-mode support	Yes
Min. cycle time	COM2 = 2.7 ms

Connection

Number of connections	1 Piece(s)
-----------------------	------------

Connection 1

Type of connection	Connector , Turning, 90°
Function	Signal IN Signal OUT Voltage supply
Thread size	M12
Type	Male
Material	Plastic
No. of pins	5 -pin
Encoding	A-coded

Mechanical data

Design	Cubic
Dimension (W x H x L)	23 mm x 50 mm x 50 mm
Housing material	Plastic , ABS
Lens cover material	Plastic
Net weight	42 g
Housing color	Red

Part no.: 50138063 – ODS110L1.3/LCT-M12 – Optical distance sensor

Type of fastening	Through-hole mounting Via optional mounting device
-------------------	---

Operation and display

Type of display	LED
Number of LEDs	2 Piece(s)
Operational controls	Control buttons PC software

Environmental data

Ambient temperature, operation	-40 ... 50 °C
Ambient temperature, storage	-40 ... 80 °C

Certifications

Degree of protection	IP 67 IP 69K
Protection class	III
Certifications	c UL US
Standards applied	IEC/EN 60947-5-2

Classification

Customs tariff number	90318020
eCl@ss 8.0	27270801
eCl@ss 9.0	27270801
ETIM 5.0	EC001825
ETIM 6.0	EC001825

Dimensioned drawings

All dimensions in millimeters

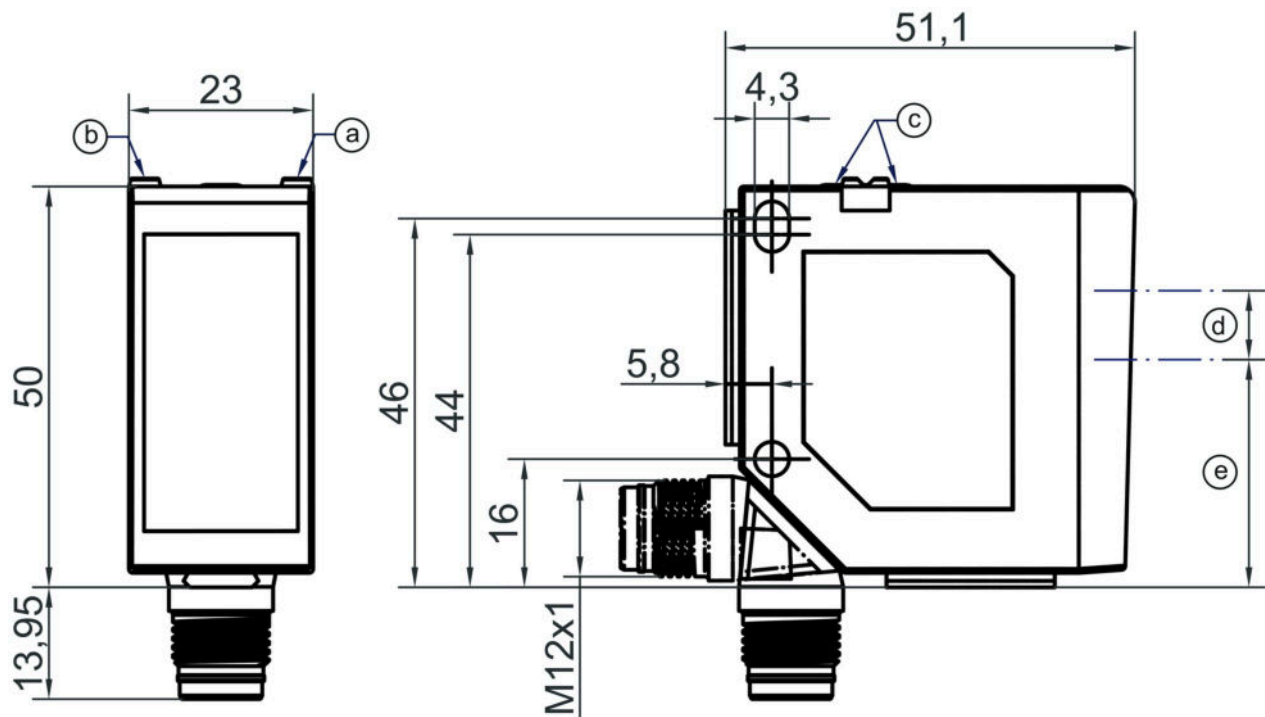

- a Yellow LED
- b Green LED
- c Control buttons
- d Transmitter
- e Receiver

Electrical connection

Connection 1	
Type of connection	Connector
Function	Signal IN Signal OUT Voltage supply
Thread size	M12
Type	Male
Material	Plastic
No. of pins	5 -pin
Encoding	A-coded

Pin	Pin assignment
1	18 ... 30 V DC +
2	OUT mA
3	GND
4	IO-Link / OUT 1
5	Teach-in

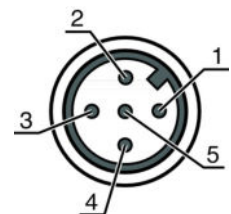

Diagrams

Repeatability (50 Hz)

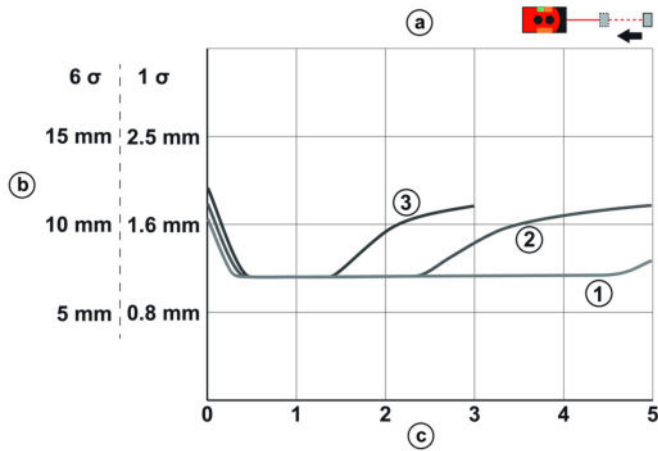

- a Axial object approach
- b Repeatability (50 Hz)
- c Distance [m]
- 1 White 90%
- 2 Gray 18%
- 3 Black 6%

Repeatability (250 Hz)

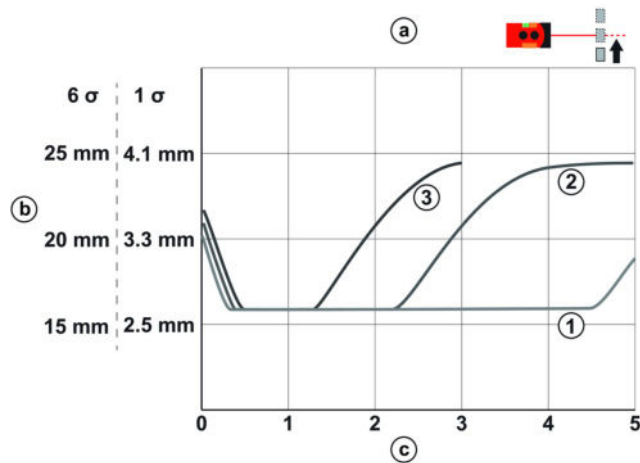

- a Lateral object approach
- b Repeatability (250 Hz)
- c Distance [m]
- 1 White 90%
- 2 Gray 18%
- 3 Black 6%

Analog characteristic curve

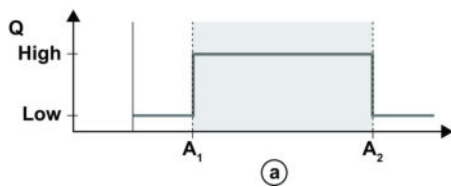
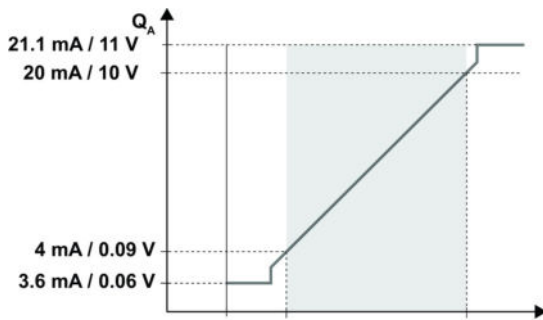

a Distance [mm]

Operation and display

LEDs

LED	Display	Meaning
1	Yellow, continuous light	Switching output/switching state
2	Green, continuous light	Operating voltage applied
	Yellow, continuous light	Analog output status display

Part number code

Part designation: **XXX110YY.Z/ABC-DDD**

XXX110	Operating principle: ODS110: Optical distance sensor HT110: diffuse reflection sensor with background suppression
YY	Light source: L1: laser class 1
Z	Equipment: 3: Control buttons for configuration
A	Switching output/function OUT 1/IN: Pin 4 or black conductor: L: IO-Link
B	Switching output / function OUT 2/IN: pin 2 or white conductor: 6: push-pull switching output, PNP light switching, NPN dark switching C: Current output T: teach-in V: Voltage output
C	Switching output / function OUT 3/IN: Pin 5: X: pin not used T: teach-in
DDD	Electrical connection: M12: M12 connector

Part no.: 50138063 – ODS110L1.3/LCT-M12 – Optical distance sensor

Note

A list with all available device types can be found on the Leuze electronic website at www.leuze.com.

Notes

Observe intended use!

- This product is not a safety sensor and is not intended as personnel protection.
- The product may only be put into operation by competent persons.
- Only use the product in accordance with its intended use.

WARNING! LASER RADIATION – LASER CLASS 1

- Observe the applicable statutory and local laser protection regulations.

WARNING! LASER RADIATION – LASER CLASS 1



The device satisfies the requirements of IEC 60825-1:2007 (EN 60825-1:2007) safety regulations for a product of **laser class 1** as well as the U.S. 21 CFR 1040.10 regulations with deviations corresponding to "Laser Notice No. 50" from June 24, 2007.

- Observe the applicable statutory and local laser protection regulations.
- The device must not be tampered with and must not be changed in any way. There are no user-serviceable parts inside the device. Repairs must only be performed by Leuze electronic GmbH + Co. KG.







- Ambient temperature, operation: UL: max. +45°
- Warmup time: minimum 20 min at +24 VDC and an ambient temperature of 20 °C
- Response time: depending on the entry direction of the object to be measured

Accessories

Connection technology - Connection cables

	Part no.	Designation	Article	Description
	50133855	KD S-M12-5A-V1-020	Connection cable	Connection 1: Connector, M12, Axial, Female, A-coded, 5 -pin Connection 2: Open end Shielded: Yes Cable length: 2,000 mm Sheathing material: PVC
	50133856	KD S-M12-5A-V1-050	Connection cable	Connection 1: Connector, M12, Axial, Female, A-coded, 5 -pin Connection 2: Open end Shielded: Yes Cable length: 5,000 mm Sheathing material: PVC

Part no.: 50138063 – ODS110L1.3/LCT-M12 – Optical distance sensor

	Part no.	Designation	Article	Description
  	50132077	KD U-M12-5A-V1-020	Connection cable	Connection 1: Connector, M12, Axial, Female, A-coded, 5 -pin Connection 2: Open end Shielded: No Cable length: 2,000 mm Sheathing material: PVC
  	50132079	KD U-M12-5A-V1-050	Connection cable	Connection 1: Connector, M12, Axial, Female, A-coded, 5 -pin Connection 2: Open end Shielded: No Cable length: 5,000 mm Sheathing material: PVC

Mounting technology - Rod mounts

	Part no.	Designation	Article	Description
	50117252	BTU 300M-D12	Mounting system	Contains: 2x M4 x 25 screw, 2x M4 x 20 screw, 4x position washers Design of mounting device: Mounting system Fastening, at system: For 12 mm rod, Sheet-metal mounting Mounting bracket, at device: Screw type, Suited for M4 screws Type of mounting device: Clampable, Adjustable, Turning, 360° Material: Metal

Note

A list with all available accessories can be found on the Leuze electronic website in the Download tab of the article detailed page.