



Model Number

RLK61-8-4000-Z/31/115

Diffuse mode sensor
with fixed cable

Features

- Cost-optimized series for standard tasks in a special design
- Compact design
- Wide range of mounting options thanks to cubic housing design with M30 thread
- 360° high visibility LEDs
- Programmable ON-delay, OFF-delay, and One-shot timers
- Version for universal voltages
- Relay output

Product information

The Series 61 sensor family is a comprehensive product line, offering five sensing modes. Each sensor is equipped with four LEDs that are highly visible from all directions, indicating Power-On, target presence and marginal excess gain. The widely recognized, polycarbonate housing provides a IP67 protection degree rating. Color-coded labels are clearly printed on the housing to easily identify the sensing mode. DC models offer a 4-in-1 output while AC/DC models have a SPDT relay output rated to 3 A. All versions come standard with an integral multifunction timer, sensitivity adjustment and Light-ON/Dark-ON switch. Series 61 sensors are cross-talk protected and have a high degree of resistance to ambient lighting. Each sensor can be mounted via front and rear slots, rear dovetail guide or M30 x 1.5 mounting base. Additionally, cabled sensor models provide 1/2" - 14 NPT internal threads for use with flexible conduit.

Dimensions

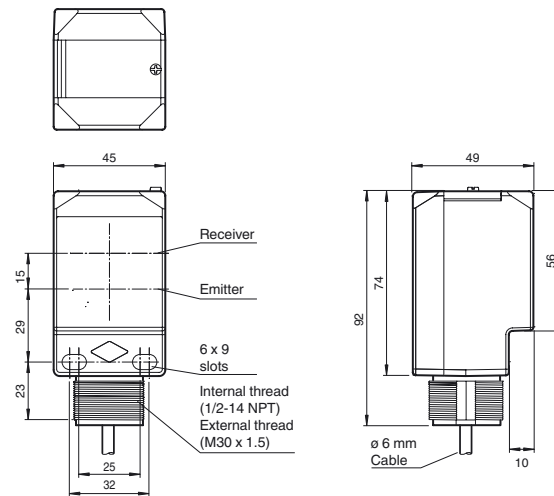

Electrical connection

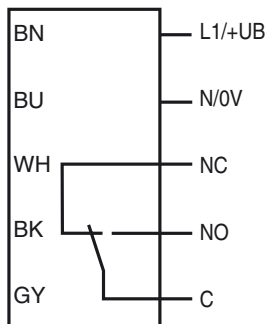

The relay-functions "NC" and "NO" bear on the switching mode "Light-ON". This complies to the default setting of the light/dark switch, located on top of the housing (factory setting).

Indicators/operating means

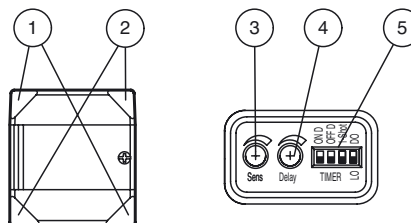

1	Operating display	green
2	Signal display	yellow
3	Sensing range adjuster	
4	Time adjuster	
5	DIP-switches	

Release date: 2014-10-30 13:09 Date of issue: 2014-10-30 911609_eng.xml

Refer to "General Notes Relating to Pepperl+Fuchs Product Information".

Technical data**General specifications**

Detection range	0 ... 4000 mm adjustable
Adjustment range	270 ... 4000 mm
Reference target	standard white 200 mm x 200 mm
Light source	IREL
Light type	modulated infrared light , 850 nm
Diameter of the light spot	approx. 45 mm at a distance of 4000 mm
Angle of divergence	0.7 °
Ambient light limit	5000 Lux ; according EN 60947-5-2

Indicators/operating means

Operation indicator	2 LEDs green
Function indicator	2 LEDs yellow ON: object inside the scanning range OFF: object outside the scanning range
Control elements	Light/Dark switch
Control elements	Detection range adjuster
Control elements	Time adjuster (0 ... 10 s)

Electrical specifications

Operating voltage	U_B	24 ... 240 V AC 12 ... 240 V DC
No-load supply current	I_0	≤ 35 mA
Protection class		II , rated voltage ≤ 250 V AC with pollution degree 1-2 according to IEC 60664-1 Output circuit basis insulation of input circuit according to EN 50178, rated insulation voltage 240 V AC
Power consumption	P_0	≤ 2 VA

Output

Switching type	light/dark on, switchable	
Signal output	Relay, 1 alternator	
Switching voltage	max. 250 V AC/DC	
Switching current	max. 3 A	
Switching power	DC: max. 150 W AC: max. 750 VA	
Switching frequency	f	20 Hz
Response time		≤ 25 ms
Timer function		DIP-switch for selection of operating modes

Ambient conditions

Ambient temperature	-40 ... 55 °C (-40 ... 131 °F)
Storage temperature	-40 ... 70 °C (-40 ... 158 °F)

Mechanical specifications

Degree of protection	IP67
Connection	2 m fixed cable
Material	
Housing	PC (Polycarbonate)
Optical face	PMMA
Mass	240 g
Tightening torque, fastening screws	≤ 2 Nm

Compliance with standards and directives

Standard conformity	
Product standard	EN 60947-5-2:2007 IEC 60947-5-2:2007

Approvals and certificates

UL approval	cULus
CCC approval	Certified by China Compulsory Certification (CCC)

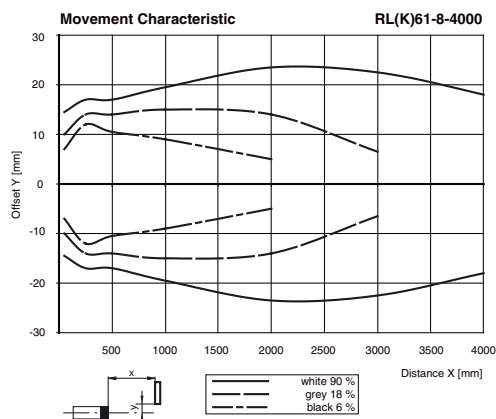
Curves/Diagrams**Accessories****MPZB01**

Mounting bracket with vertical slots

MPZB02

Mounting bracket with circular slots

MPZB06

Ball and Swivel Mounting Bracket

MPZB07

Ball and Swivel Vertical Mounting Plate

Other suitable accessories can be found at www.pepperl-fuchs.com

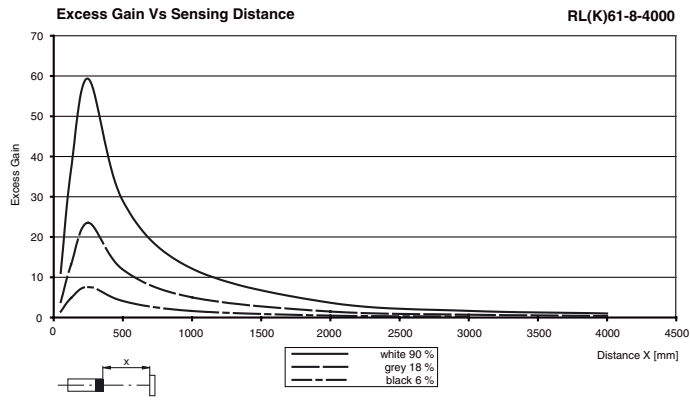

Release date: 2014-10-30 13:09 Date of issue: 2014-10-30 911609_eng.xml

Refer to "General Notes Relating to Pepperl+Fuchs Product Information".



Pepperl+Fuchs Group
www.pepperl-fuchs.com

USA: +1 330 486 0001
fa-info@us.pepperl-fuchs.com

Germany: +49 621 776 4411
fa-info@de.pepperl-fuchs.com

Singapore: +65 6779 9091
fa-info@sg.pepperl-fuchs.com

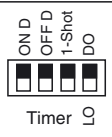
Timer Functions

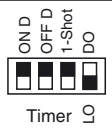
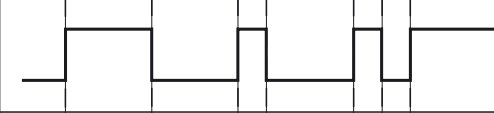
Switching Type	Detection Status	Operation Mode	Light Received	No Light Received
L.ON  OFF ON ON D OFF D 1-Shot DO LO Timer		No Delay (Timer OFF)	ON	OFF
		ON Delay	ON	OFF
		OFF Delay	ON	OFF
		One-Shot Delay	ON	OFF
		ON Delay and OFF Delay	ON	OFF
D.ON  OFF ON ON D OFF D 1-Shot DO LO Timer		No Delay (Timer OFF)	ON	OFF
		ON Delay	ON	OFF
		OFF Delay	ON	OFF
		One-Shot Delay	ON	OFF
		ON Delay and OFF Delay	ON	OFF

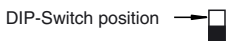

Time (T) is adjustable from 0 to 10 sec

Release date: 2014-10-30 13:09 Date of issue: 2014-10-30 911609_eng.xml

Adjustment Instructions

Intended use:

The diffuse mode sensor contains the emitter and receiver in a single housing. The light from transmitter is reflected back from the target object and is evaluated by the receiver. The sensing range depends on the object color and finish. With dark or very small objects, the sensing range is reduced.

Mounting instructions

The sensor can be mounted using the through-holes or with a mounting bracket (not included with delivery).

The base surface must be flat to avoid distorting the sensor housing during mounting. It is advisable to secure the bolts and screws with washers so that the sensor does not become misaligned.

Adjustment Instructions:

Adjust the sensor on the background. If the yellow LED illuminates, reduce the sensing range using the potentiometer until the yellow LED turns off.

Object detection:

Move the target into the light beam. Position the light spot on the object. If the object is detected, the yellow LED lights up. If it does not light up, further adjust the sensing range with the potentiometer until the yellow LED lights up.

Cleaning:

We recommend that you clean the optical interfaces and check all connections at regular intervals.