

Actuator/sensor cable, PUR
Connection cable
RSS8T-2/TXL

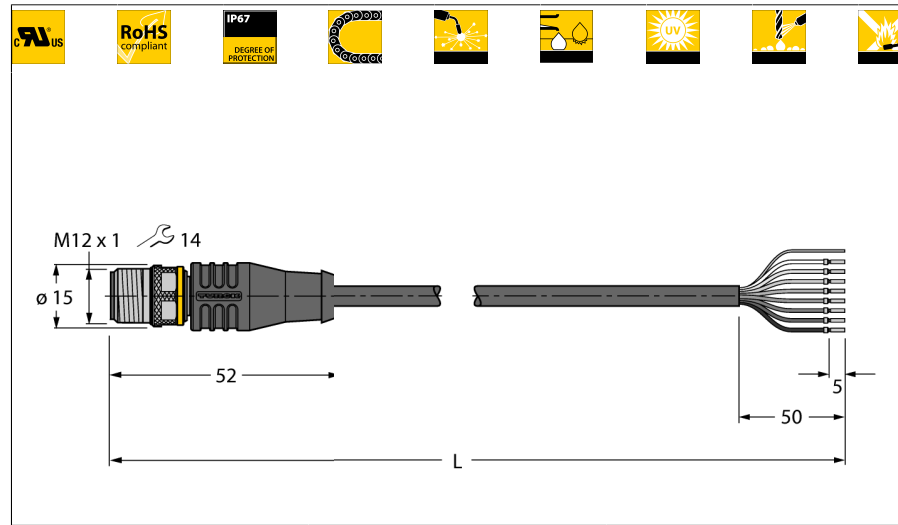

- Male M12, straight, 8-pin
- Shield on coupling nut/screw
- Sheath material: PUR, shielded
- Sheath color: black
- Qualified for drag chain use
- Resistant to weld splatter
- Resistant to chemicals, UV radiation and oils
- Flame retardant
- Free from halogen, silicone, PVC and LABS
- Particularly resistant to abrasion
- Approval: cULus
- RoHS conform
- Protection class IP67
- Cable length: 2.0 m

Type designation RSS8T-2/TXL
Ident no. 6625464

Connector A side
 Connector, M12 ♂ 1, Straight
 Number of pins 8
 Contacts Brass, CuZn, Gold-plated
 Contact carriers Plastic, TPU, Black
 Grip Plastic, TPU, Black
 Coupling nut/screw Brass, CuZn, Nickel-plated
 Protection class IP67, A + B side screwed together
 Mechanical lifespan > 100 Mating cycles
 Pollution degree 3
 Tightening torque 0.8 ... 1 Nm
 (observe max. torque of counter piece!)

General data
 Cable diameter 6.3 ± 0.20mm
 Cable length 2 m
 Cable quality PUR
 Cable color Black
 Core insulation PP
 Core colors WH, BN, GN, YE, GY, PK, BU, RD
 Core cross-section 8x0.25mm²
 Arrangement of strands 32x0.1 mm
 Shielding Aluminum foil, tinned copper wire

Electrical features at +20 °C
 Current 2 A
 Rated voltage 30 V
 Insulation resistance > 30.5 MΩ/km
 Test voltage 2000 V
 Forward resistance max. 79 Ω/km

Cable Cross-section

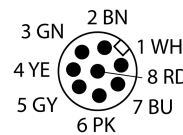
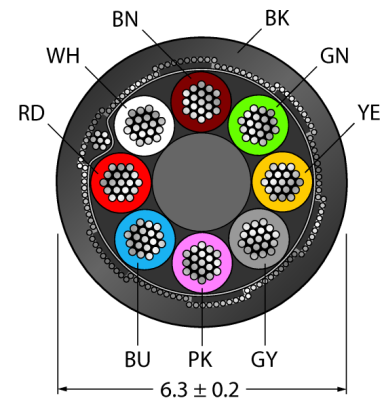

Drawing shows design status including hexagon coupling nut
 (Start of production CW42/2016).

Circuit Diagram

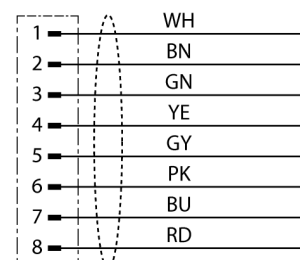

Actuator/sensor cable, PUR
Connection cable
RSS8T-2/TXL

TURCK



Industrial
Automation

Mechanical and chemical properties

Max. tensile strength (static)	≤ 50 N/mm ²
Max. tensile strength (dynamic)	≤ 20 N/mm ²
Bending cycles	> 2 mil.
Bending radius (stationary laying)	> 5 x Ø
Bending radius (flexible use)	> 10 x Ø
Admissible acceleration	max. 5 m/s ²
Admissible travel path, horizontal	5 m (at 5 m/s ²)
Admissible travel path, vertical	2 m (at 5 m/s ²)
Admissible traversing speed	3.3 m/s
Torsional stress	± 180 °/m
Ambient temperature	
Stationary	-50...+80°C
In motion	-25...+80°C
Drag chain operation	-25...+60°C

Actuator/sensor cable, PUR
Connection cable
RSS8T-2/TXL

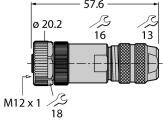
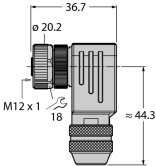
Accessories

Type code	Ident no.	Description	
CMB8181-0	6931450	Field-wireable female connector, M12 ⌀ 1, straight, 8-pin, screw terminal connection, cable feedthrough 6.0 to 8.0 mm, core cross-section/terminal capacity 0.14 to 0.50 mm ² , metal housing, metal nut, shieldable	
CMB8281-0	6932024	Field-wireable female connector, M12 ⌀ 1, angled, 8-pin, screw terminal connection, cable feedthrough 6.0 to 8.0 mm, core cross-section/terminal capacity 0.14 to 0.50 mm ² , metal housing, metal nut, shieldable	
Torque-Wrench-Set-AS	6936170	Torque wrench set; handles with adjustable torque 0.4-1.0 Nm, torque wrench for M8 (SW9), fork wrench for M12 (SW 14)	
BLANK-LABEL-FOR-CORDESETS-TEL-TXL	6936206	Label for TEL and TXL cables, length: 18 mm, height: 4 mm, material: polycarbonate (PC), color: white, halogen-free and flame-retardant	