

TP5KP Series

Axial Leaded – 5 kW

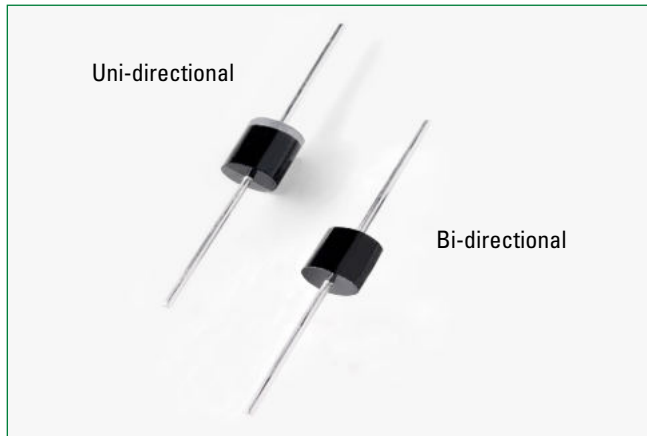

Additional Information



Resources



Accessories



Samples

Agency Approvals

| Agency | Agency File Number |
|--------|--------------------|
| | E230531 |

Maximum Ratings and Thermal Characteristics ($T_A=25^{\circ}\text{C}$ unless otherwise noted)

| Parameter | Symbol | Value | Unit |
|--|-----------------|------------|-----------------------------|
| Peak Pulse Power Dissipation by 10/1000 μs Test Waveform (Fig.2)(Note 1) | P_{PPM} | 5000 | W |
| Steady State Power Dissipation on Infinite Heat Sink at $T_J=75^{\circ}\text{C}$ | P_D | 8.0 | W |
| Peak Forward Surge Current, 8.3ms Single Half Sine Wave Unidirectional Only (Note 2) | I_{FSM} | 400 | A |
| Maximum Instantaneous Forward Voltage at 100A for Unidirectional Only (Note 3) | V_F | 3.5 | V |
| Operating Junction Temperature Range | T_J | -55 to 150 | $^{\circ}\text{C}$ |
| Storage Temperature Range | T_{STG} | -55 to 175 | $^{\circ}\text{C}$ |
| Typical Thermal Resistance Junction to Lead | $R_{\theta JL}$ | 8.0 | $^{\circ}\text{C}/\text{W}$ |
| Typical Thermal Resistance Junction to Ambient | $R_{\theta JA}$ | 40 | $^{\circ}\text{C}/\text{W}$ |

Notes:

- Non-repetitive current pulse, per Fig. 4 and derated above T_J (initial) $=25^{\circ}\text{C}$ per Fig. 3.
- Measured on 8.3ms single half sine wave or equivalent square wave, duty cycle=4 per minute maximum.

Description

The TP5KP Series is designed specifically to protect sensitive electronic equipment from voltage transients induced by lightning and other transient voltage events.

Features & Benefits

- Hi reliability application and automotive grade AEC Q101 qualified
- Glass passivated chip junction in P600 package
- 5000W peak pulse capability at 10/1000 μs waveform, repetition rate (duty cycles):0.01%
- Fast response time: typically less than 1.0ps from 0 Volts to BV min
- Excellent clamping capability
- Typical failure mode is short from over-specified voltage or current
- Whisker test is conducted based on JEDEC JESD201A per its table 4a and 4c
- IEC-61000-4-2 ESD 30kV(Air), 30kV (Contact)
- ESD protection of data lines in accordance with IEC 61000-4-2
- EFT protection of data lines in accordance with IEC 61000-4-4
- Low incremental surge resistance
- Typical I_R less than 2 μA when $V_{BR \text{ min}} > 12\text{V}$
- High temperature to reflow soldering guaranteed: 260 $^{\circ}\text{C}/10\text{sec} / 0.375"$, (9.5mm) lead length, 5 lbs., (2.3kg) tension
- $V_{BR} @ T_J = V_{BR} @ 25^{\circ}\text{C} \times (1 + \alpha T \times (T_J - 25))$ (αT : Temperature Coefficient, typical value is 0.1%)
- Plastic package is flammability rated V-0 per Underwriters Laboratories
- Matte tin lead-free plated
- Halogen free and RoHS compliant
- Pb-free E3 means 2nd level interconnect is Pb-free and the terminal finish material is tin(Sn) (IPC/JEDEC J-STD-609A.01)

Applications

TVS devices are ideal for the protection of I/O interfaces, V_{CC} bus and other vulnerable circuits used in telecom, computer, industrial and consumer electronic applications.

Functional Diagram

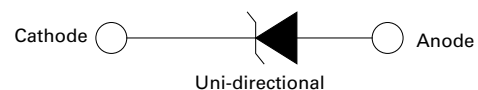
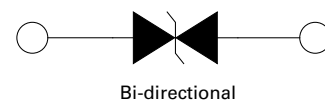

TP5KP Series

Axial Leaded – 5 kW

Electrical Characteristics ($T_A=25^\circ\text{C}$ unless otherwise noted)

| Part Number (Uni) | Part Number (Bi) | Reverse Stand off Voltage V_R (Volts) | Breakdown Voltage V_{BR} (Volts) @ I_T | | Test Current I_T (mA) | Maximum Clamping Voltage V_C @ I_{PP} (V) | Maximum Peak Pulse Current I_{PP} (A) | Maximum Reverse Leakage I_R @ V_R (μA) | Agency Approval |
|-------------------|------------------|---|--|-------|-------------------------|---|---|---|-----------------|
| | | | MIN | MAX | | | | | |
| TP5KP10A | TP5KP10CA | 10.0 | 11.10 | 12.30 | 5 | 17.0 | 300.0 | 15 | X |
| TP5KP11A | TP5KP11CA | 11.0 | 12.20 | 13.50 | 5 | 18.2 | 280.2 | 2 | X |
| TP5KP12A | TP5KP12CA | 12.0 | 13.30 | 14.70 | 5 | 19.9 | 256.3 | 2 | X |
| TP5KP13A | TP5KP13CA | 13.0 | 14.40 | 15.90 | 5 | 21.5 | 237.2 | 2 | X |
| TP5KP14A | TP5KP14CA | 14.0 | 15.60 | 17.20 | 5 | 23.2 | 219.8 | 2 | X |
| TP5KP15A | TP5KP15CA | 15.0 | 16.70 | 18.50 | 5 | 24.4 | 209.0 | 2 | X |
| TP5KP16A | TP5KP16CA | 16.0 | 17.80 | 19.70 | 5 | 26.0 | 196.2 | 2 | X |
| TP5KP17A | TP5KP17CA | 17.0 | 18.90 | 20.90 | 5 | 27.6 | 184.8 | 2 | X |
| TP5KP18A | TP5KP18CA | 18.0 | 20.00 | 22.10 | 5 | 29.2 | 174.7 | 2 | X |
| TP5KP20A | TP5KP20CA | 20.0 | 22.20 | 24.50 | 5 | 32.4 | 157.4 | 2 | X |
| TP5KP22A | TP5KP22CA | 22.0 | 24.00 | 26.90 | 5 | 35.5 | 143.7 | 2 | X |
| TP5KP24A | TP5KP24CA | 24.0 | 26.70 | 29.50 | 5 | 38.9 | 131.1 | 2 | X |
| TP5KP26A | TP5KP26CA | 26.0 | 28.90 | 31.90 | 5 | 42.1 | 121.1 | 2 | X |
| TP5KP28A | TP5KP28CA | 28.0 | 31.10 | 34.40 | 5 | 45.4 | 112.3 | 2 | X |
| TP5KP30A | TP5KP30CA | 30.0 | 33.30 | 36.80 | 5 | 48.4 | 105.4 | 2 | X |
| TP5KP33A | TP5KP33CA | 33.0 | 36.70 | 40.60 | 5 | 53.3 | 95.7 | 2 | X |
| TP5KP36A | TP5KP36CA | 36.0 | 40.00 | 44.20 | 5 | 58.1 | 87.8 | 2 | X |
| TP5KP40A | TP5KP40CA | 40.0 | 44.40 | 49.10 | 5 | 64.5 | 79.1 | 2 | X |
| TP5KP43A | TP5KP43CA | 43.0 | 47.80 | 52.80 | 5 | 69.4 | 73.5 | 2 | X |
| TP5KP45A | TP5KP45CA | 45.0 | 50.00 | 55.30 | 5 | 72.7 | 70.2 | 2 | X |
| TP5KP48A | TP5KP48CA | 48.0 | 53.30 | 58.90 | 5 | 77.4 | 65.9 | 2 | X |
| TP5KP51A | TP5KP51CA | 51.0 | 56.70 | 62.70 | 5 | 82.4 | 61.9 | 2 | X |
| TP5KP54A | TP5KP54CA | 54.0 | 60.00 | 66.30 | 5 | 87.1 | 58.6 | 2 | X |
| TP5KP58A | TP5KP58CA | 58.0 | 64.40 | 71.20 | 5 | 93.6 | 54.5 | 2 | X |
| TP5KP60A | TP5KP60CA | 60.0 | 66.70 | 73.70 | 5 | 96.8 | 52.7 | 2 | X |

I-V Curve Characteristics

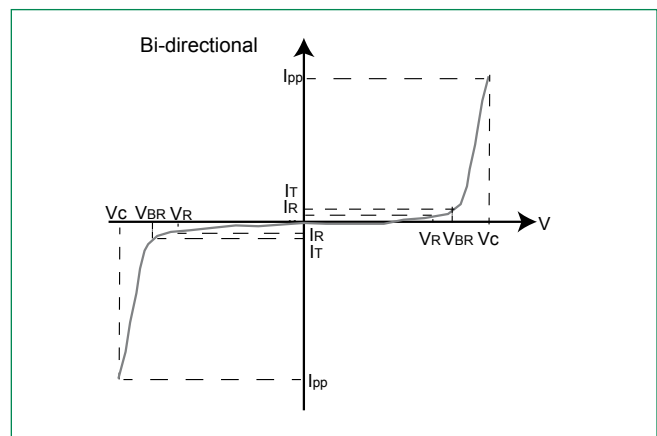
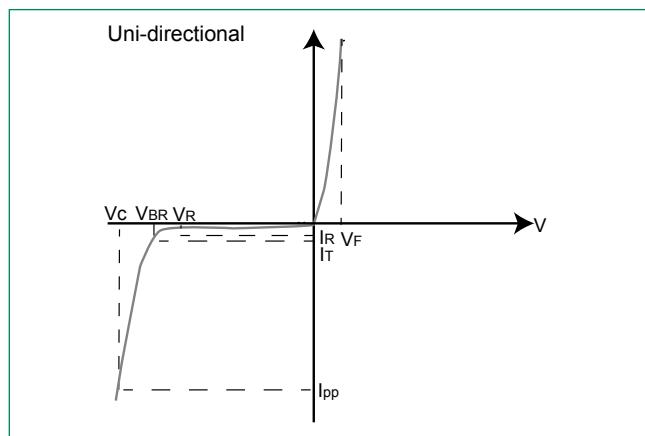

P_{PPM} Peak Pulse Power Dissipation -- Max power dissipation
 V_R Stand-off Voltage -- Maximum voltage that can be applied to the TVS without operation
 V_{BR} Breakdown Voltage -- Maximum voltage that flows though the TVS at a specified test current (I_T)
 V_C Clamping Voltage -- Peak voltage measured across the TVS at a specified I_{PPM} (peak impulse current)
 I_R Reverse Leakage Current -- Current measured at V_R
 V_F Forward Voltage Drop for Uni-directional

TP5KP Series

Axial Leaded – 5 kW

Ratings and Characteristic Curves ($T_A=25^\circ\text{C}$ unless otherwise noted)

Figure 1 - TVS Transients Clamping Waveform

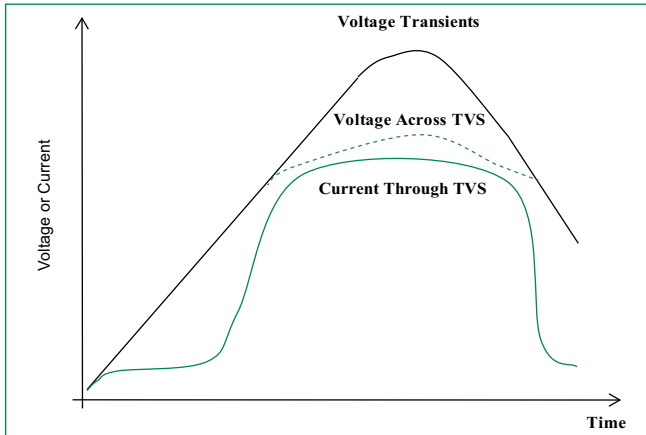

Figure 2 - Peak Pulse Power Rating Curve

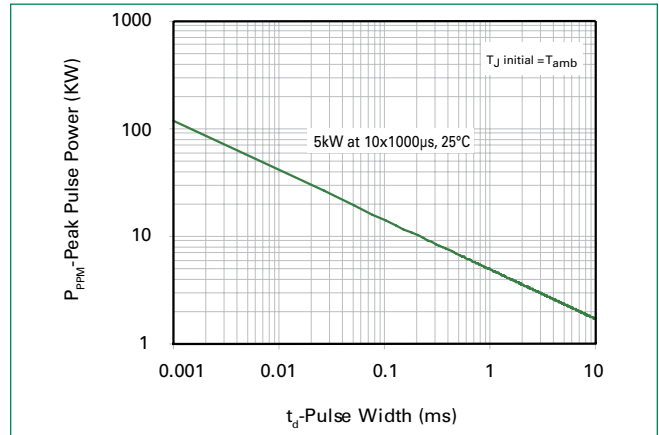

Figure 3 - Peak Pulse Power Derating Curve

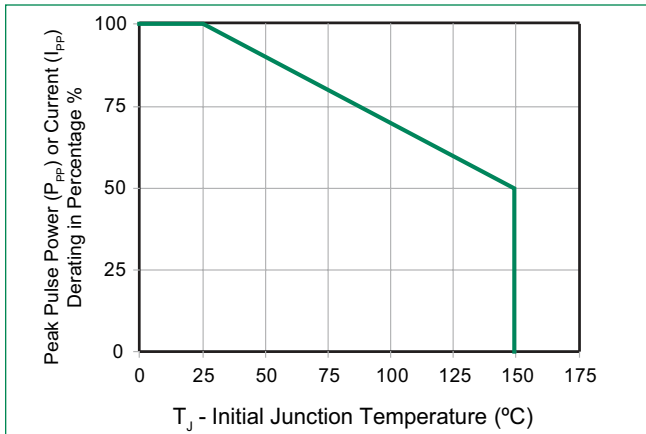

Figure 4 - Pulse Waveform

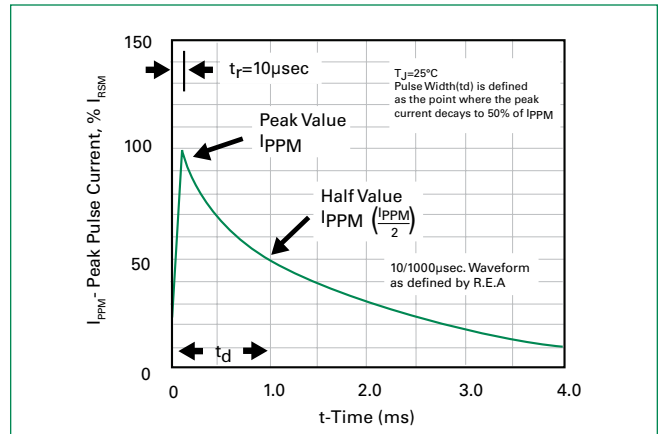

Figure 5 - Typical Junction Capacitance

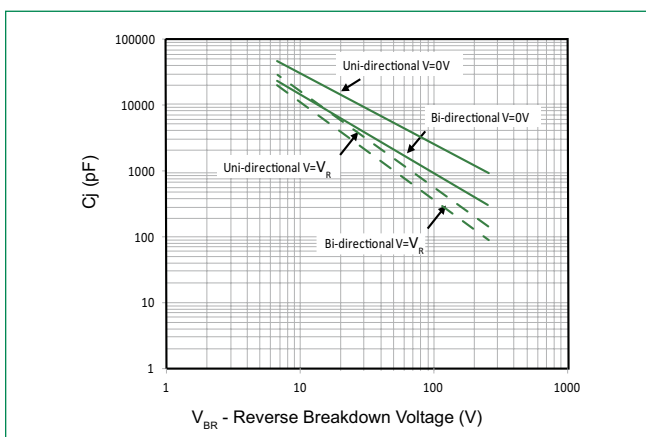
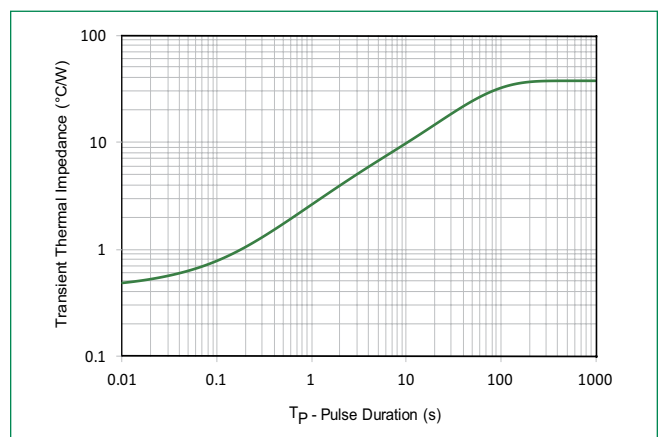

Figure 6 - Typical Transient Thermal Impedance



TP5KP Series

Axial Leaded – 5 kW

Figure 7 - Maximum Non-Repetitive Peak Forward Surge Current Uni-Directional Only

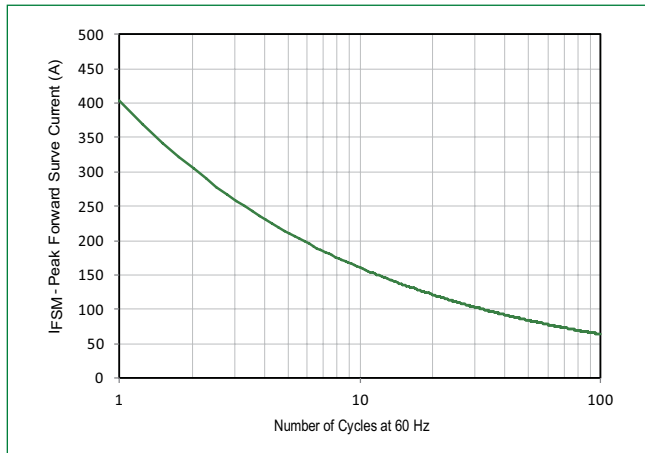
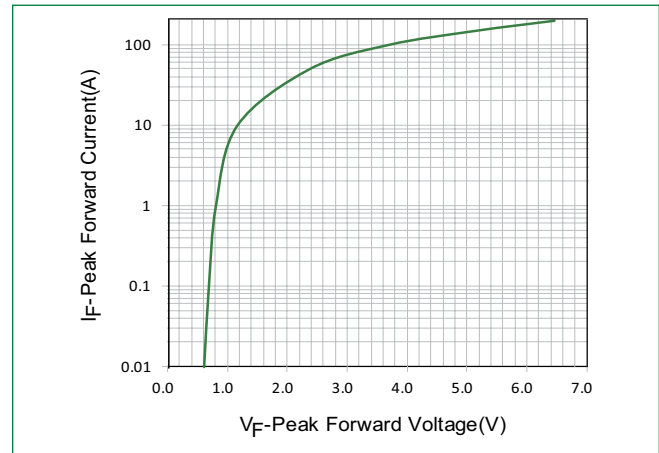
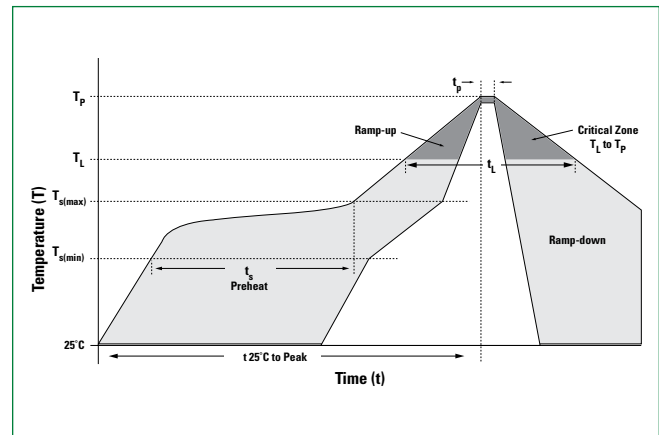

Figure 8 - Peak Forward Voltage Drop vs Peak Forward Current (Typical Values)



Soldering Parameters

| | | |
|--|------------------------------------|------------------|
| Reflow Condition | Lead-free assembly | |
| Pre Heat | - Temperature Min ($T_{s(min)}$) | 150°C |
| | - Temperature Max ($T_{s(max)}$) | 200°C |
| | - Time (min to max) (t_s) | 60 - 120 secs |
| Average ramp up rate (Liquidus Temp (T_A) to peak) | 3°C/second max | |
| $T_{s(max)}$ to T_A - Ramp-up Rate | 3°C/second max | |
| Reflow | - Temperature (T_A) (Liquidus) | 217°C |
| | - Time (min to max) (t_s) | 60 – 150 seconds |
| Peak Temperature (T_p) | 260 ^{+0/-5} °C | |
| Time within 5°C of actual peak Temperature (t_p) | 30 seconds | |
| Ramp-down Rate | 6°C/second max | |
| Time 25°C to peak Temperature (T_p) | 8 minutes Max. | |
| Do not exceed | 260°C | |



Physical Specifications

| | |
|-----------------|--|
| Weight | 0.07oz., 2.1g |
| Case | P600 molded plastic body over passivated junction. |
| Polarity | Color band denotes the cathode except Bipolar. |
| Terminal | Matte Tin axial leads, solderable per JESD22-B102. |

Flow/Wave Soldering (Solder Dipping)

| | |
|---------------------------|------------|
| Peak Temperature : | 265°C |
| Dipping Time : | 10 seconds |
| Soldering : | 1 time |

Environmental Specifications

| | |
|----------------------------|-------------|
| High Temp. Storage | JESD22-A103 |
| HTRB | JESD22-A108 |
| Temperature Cycling | JESD22-A104 |
| H3TRB | JESD22-A101 |
| RSH | JESD22-B106 |

TP5KP Series

Axial Leaded – 5 kW

Dimensions

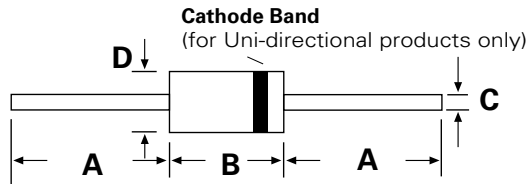

| Dimensions | Inches | | Millimeters | |
|------------|--------|-------|-------------|------|
| | Min | Max | Min | Max |
| A | 1.000 | - | 25.40 | - |
| B | 0.340 | 0.360 | 8.60 | 9.10 |
| C | 0.048 | 0.052 | 1.22 | 1.32 |
| D | 0.340 | 0.360 | 8.60 | 9.10 |

P600

Part Numbering System

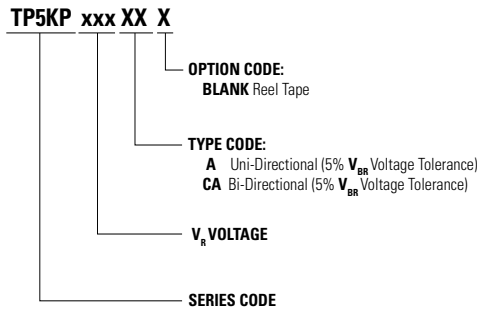

Part Marking System

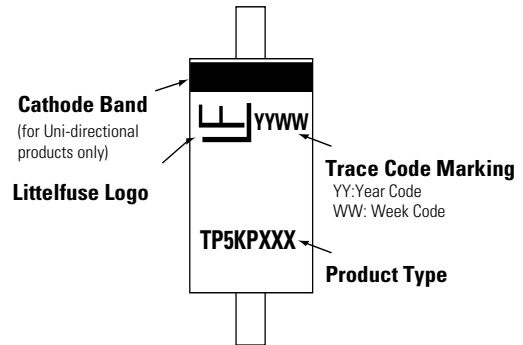

Packing Options

| Part Number | Component Package | Quantity | Packaging Option | Packaging Specification |
|-------------|-------------------|----------|------------------|-------------------------|
| TP5KPxxxXX | P600 | 800 | Tape & Reel | EIA STD RS-296 |

Tape and Reel Specification

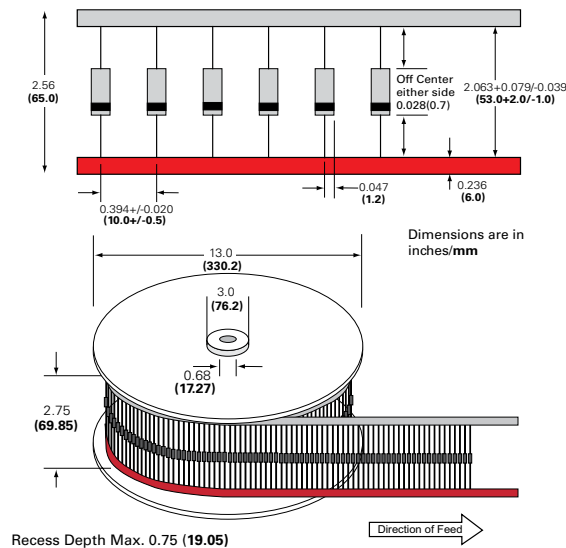

Disclaimer Notice - Information furnished is believed to be accurate and reliable. However, users should independently evaluate the suitability of and test each product selected for their own applications. Littelfuse products are not designed for, and may not be used in, all applications. Read complete Disclaimer Notice at <http://www.littelfuse.com/disclaimer-electronics>.