

HRTR 8

Diffuse reflection light scanner with background suppression

en 07-2014/08 50110746



Dimensioned drawing

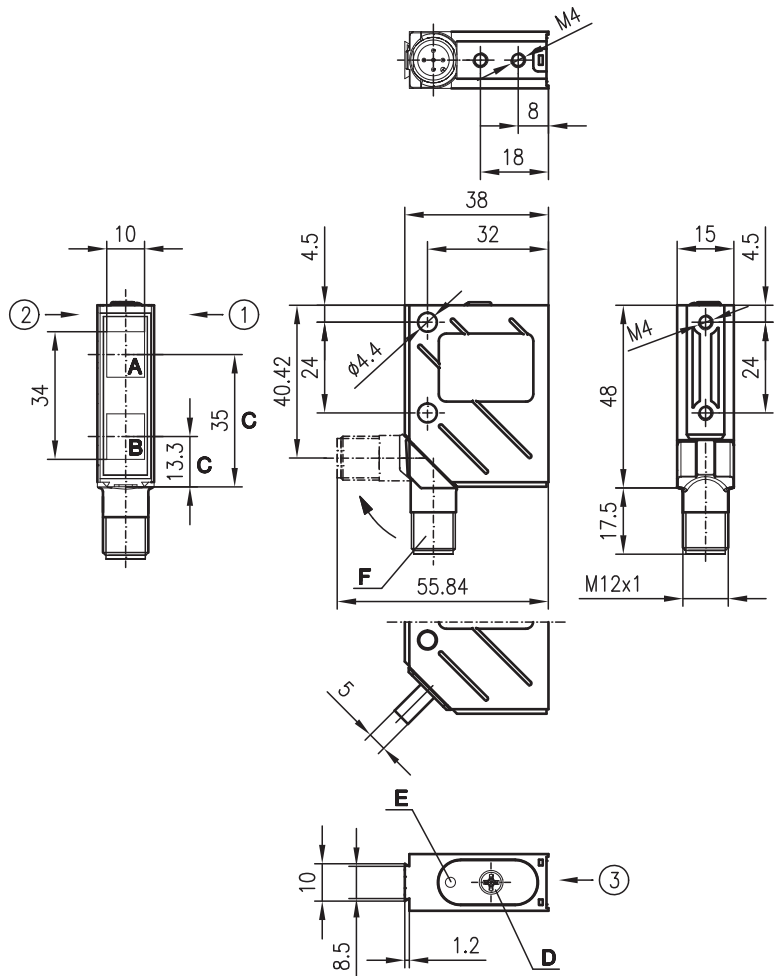

- A** Receiver
 - B** Transmitter
 - C** Optical axis
 - D** Operational control
 - E** Yellow LED
 - F** 90° turning connector
- Preferred entry direction for objects ① + ② + ③

Electrical connection

HRTR 8/66-350
 HRTR 8/66-350-S12
 HRTR 8/66-350,5000

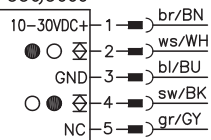

HRTR 8/44-350
 HRTR 8/44-350-S12

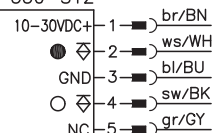

5 ... 400mm

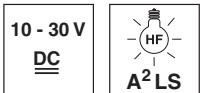

- Adjustable background suppression
- A²LS - active suppression of extraneous light
- Push-pull switching outputs
- M12 turning connector or cable connection
- Visible red light

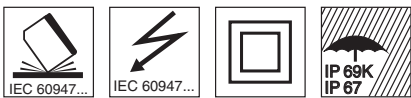

Accessories:

(available separately)

- M12 connectors (KD ...)
- Ready-made cables (K-D ...)
- Mounting systems
- Control guard

We reserve the right to make changes • DS_HRTR8Standard_en_50110746.fm

Specifications

Optical data

Typ. scanning range limit (white 90%) ¹⁾	5 ... 400mm
Scanning range ²⁾	see tables
Mechanical adjustment range	50 ... 400mm
Light source	LED (modulated light)
Wavelength	660nm (visible red light)

Timing

Switching frequency	1000Hz
Response time	0.5ms
Delay before start-up	≤ 100ms

Electrical data

Operating voltage U_B ³⁾	10 ... 30VDC
Residual ripple	≤ 15% of U_B
Bias current	≤ 35mA
Switching output/function	.../66 2 push-pull switching outputs ⁴⁾ pin 2: PNP dark switching, NPN light switching pin 4: PNP light switching, NPN dark switching
	.../44 2 PNP switching outputs pin 2: dark switching pin 4: light switching
Signal voltage high/low	≥ ($U_B - 2V$) / ≤ 2V
Output current	max. 100mA
Scanning range adjustment	mechanical via multiturn potentiometer

Indicators

Yellow LED	object detected
------------	-----------------

Mechanical data

Housing	metal
Optics cover	glass
Weight (plug/cable)	70g/140g
Connection type	M12 connector, 5-pin or cable: 2000mm or 5000mm, 5x0.25mm ²

Environmental data

Ambient temp. (operation/storage)	-40°C ... +60°C / -40°C ... +70°C
Protective circuit ⁵⁾	2, 3
VDE safety class ⁶⁾	II, all-insulated
Protection class ⁷⁾	IP 67, IP 69K ⁸⁾
Light source	exempt group (in acc. with EN 62471)
Standards applied	IEC 60947-5-2
Certifications	UL 508, C22.2 No.14-13 ³⁾ 9)

- 1) Typ. scanning range limit: max. attainable range without performance reserve
- 2) Scanning range: recommended range with performance reserve
- 3) For UL applications: for use in class 2 circuits according to NEC only
- 4) The push-pull switching outputs must not be connected in parallel
- 5) 2=polarity reversal protection, 3=short-circuit protection for all outputs
- 6) Rating voltage 250VAC
- 7) In stop position of the turning connector (turning connector locked)
- 8) IP 69K test acc. to DIN 40050 part 9 simulated, high pressure cleaning conditions without the use of additives, acids and bases are not part of the test
- 9) These proximity switches shall be used with UL Listed Cable assemblies rated 30V, 0.5A min, in the field installation, or equivalent (categories: CYJV/CYJV7 or PVVA/PVVA7)

Order guide

	Designation	Part No.
With M12 connector	HRTR 8/44-350-S12	50036350
With 2m cable	HRTR 8/44-350	50036351
With M12 connector	HRTR 8/66-350-S12	50036352
With 2m cable	HRTR 8/66-350	50036353
With 5m cable	HRTR 8/66-350,5000	50108224

Tables

1	7	350	400
2	10	330	370
3	12	300	340

1	white 90%
2	grey 18%
3	black 6%

	Scanning range [mm]
	Typ. scanning range limit [mm]

Diagrams

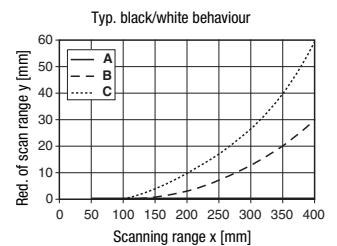
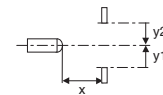
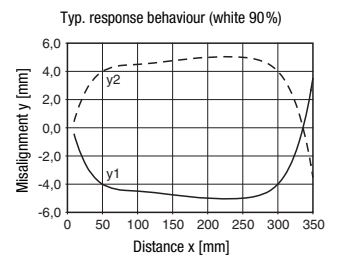

- A white 90%
- B grey 18%
- C black 6%

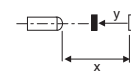

Remarks

Operate in accordance with intended use!
<ul style="list-style-type: none"> This product is not a safety sensor and is not intended as personnel protection. The product may only be put into operation by competent persons. Only use the product in accordance with the intended use.