

High Speed Quad-Channel Digital Isolator

Product Preview

NCID9401, NCID9411

Description

The NCID94xx is a galvanically isolated high-speed quad-channel digital isolator with output enable. This device supports isolated communications thereby allowing digital signals to communicate between systems without conducting ground loops or hazardous voltages.

It utilizes ON Semiconductor's patented galvanic off-chip capacitor isolation technology and optimized IC design to achieve high insulation and high noise immunity, characterized by high common mode rejection and power supply rejection specifications. The thick ceramic substrate yields capacitors with ~25 times the thickness of thin film on-chip capacitors and coreless transformers. The result is a combination of the electrical performance benefits that digital isolators offer with the safety reliability of a >0.5 mm insulator barrier similar to what has historically been offered by optocouplers.

The device is housed in a 16-pin wide body small outline package.

Features

- Off-Chip Capacitive Isolation to Achieve Reliable High Voltage Insulation
 - ◆ DTI (Distance Through Insulation): ≥ 0.5 mm
 - ◆ Maximum Working Insulation Voltage: $2000 V_{peak}$
- Bi-directional Communication
- 100 kV/ μ s Minimum Common Mode Rejection
- 8 mm Creepage and Clearance Distance to Achieve Reliable High Voltage Insulation
- Specifications Guaranteed Over 2.5 V to 5.5 V Supply Voltage and -40°C to 125°C Extended Temperature Range
- Over Temperature Detection
- Output Enable Function (Primary and Secondary side)
- NCIV Prefix for Automotive and Other Applications Requiring Unique Site and Control Change Requirements; AEC-Q100 Qualified and PPAP Capable (Pending)
- Safety and Regulatory Approvals
 - ◆ UL1577, 5000 VRMS for 1 Minute
 - ◆ DIN VDE V 0884-11 (Pending)

Typical Applications

- Isolated PWM Control
- Industrial Fieldbus Communications
- Microprocessor System Interface (SPI, I²C, etc.)
- Programmable Logic Control
- Isolated Data Acquisition System
- Voltage Level Translator

This document contains information on a product under development. ON Semiconductor reserves the right to change or discontinue this product without notice.



ON Semiconductor®

www.onsemi.com



SOIC16 W
CASE 751EN

MARKING DIAGRAM

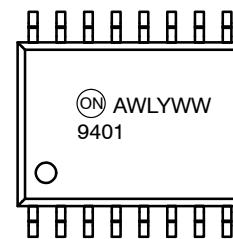

A	= Assembly Location
WL	= Wafer Lot / Assembly Lot
Y	= Year
WW	= Work Week
9401/9411	= Specific Device Code

ORDERING INFORMATION

See detailed ordering and shipping information on page 13 of this data sheet.

NCID9401, NCID9411

BLOCK DIAGRAM

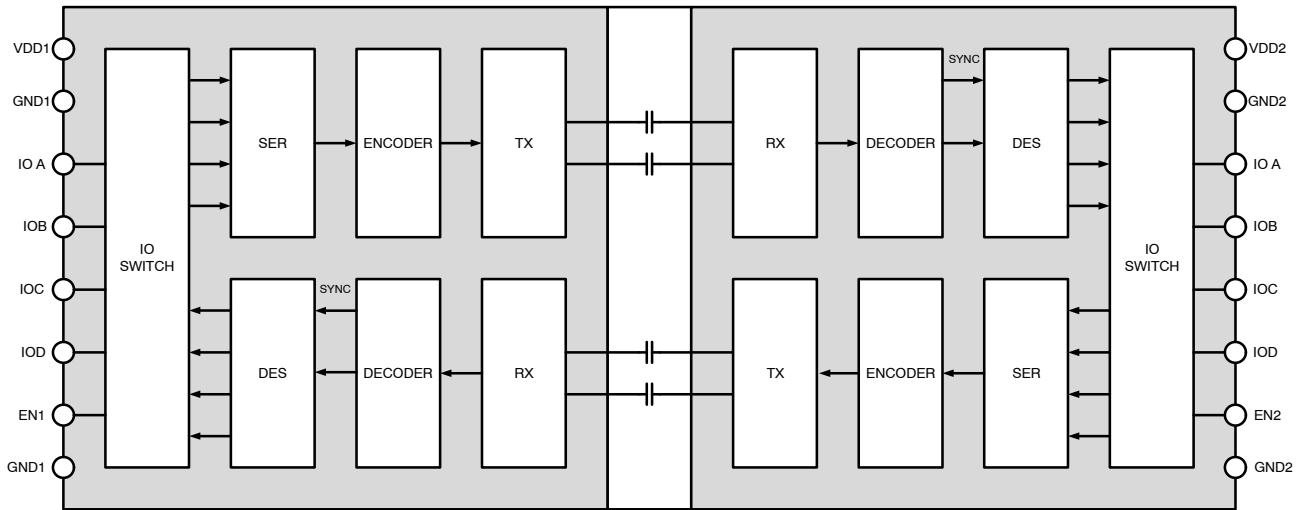

Figure 1. Functional Block Diagram

NCID9401, NCID9411

PIN CONFIGURATION

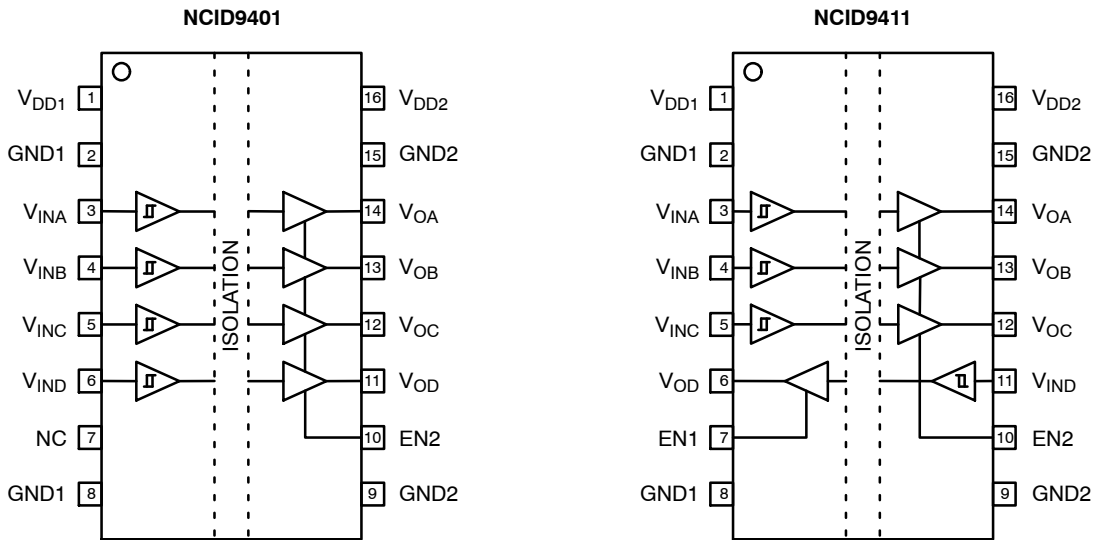

Figure 2. Pin and Channel Configuration

PIN DEFINITION

Name	Pin No. NCID9401	Pin No. NCID9411	Description
V _{DD1}	1	1	Power Supply, Side 1
GND1	2	2	Ground Connection for V _{DD1}
V _{INA}	3	3	Input, Channel A
V _{INB}	4	4	Input, Channel B
V _{INC}	5	5	Input, Channel C
V _{IND}	6	11	Input, Channel D
EN1	-	7	Output Enable 1
GND1	8	8	Ground Connection for V _{DD1}
GND2	9	9	Ground Connection for V _{DD2}
EN2	10	10	Output Enable 2
V _{OD}	11	6	Output, Channel D
V _{OC}	12	12	Output, Channel C
V _{OB}	13	13	Output, Channel B
V _{OA}	14	14	Output, Channel A
GND2	15	15	Ground Connection for V _{DD2}
V _{DD2}	16	16	Power Supply, Side 2
NC	7	-	No Connect

NCID9401, NCID9411

SPECIFICATIONS

TRUTH TABLE (Note 1)

V _{INX}	EN _X	V _{DDI}	V _{DDO}	V _{OX}	Comment
H	H/NC	Power Up	Power Up	H	Normal Operation
L	H/NC	Power Up	Power Up	L	Normal Operation
X	L	Power Up	Power Up	Hi-Z	
X	H/NC	Power Down	Power Up	L	Default low; V _{OX} return to normal operation when V _{DDI} change to Power Up
X	H/NC	Power Up	Power Down	Undetermined (Note 2)	V _{OX} return to normal operation when V _{DDO} change to Power Up

- V_{INX} = Input signal of a given channel (A, B, C or D). EN_X = Enable pin for primary or secondary side (1 or 2). V_{OX} = Output signal of a given channel (A, B, C or D). V_{DDI} = Input-side V_{DD}. V_{DDO} = Output-side V_{DD}. X = Irrelevant. H = High level. L = Low level. NC = No Connection.
- The outputs are in undetermined state when V_{DDO} < V_{UVLO}.

SAFETY AND INSULATION RATINGS

As per DIN VDE V 0884-11, this digital isolator is suitable for "safe electrical insulation" only within the safety limit data. Compliance with the safety ratings must be ensured by means of protective circuits.

Symbol	Parameter	Min	Typ	Max	Unit
	Installation Classifications per DIN VDE 0110/1.89 Table 1 Rated Mains Voltage	< 150 V _{RMS}	-	I-IV	-
		< 300 V _{RMS}	-	I-IV	-
		< 450 V _{RMS}	-	I-IV	-
		< 600 V _{RMS}	-	I-IV	-
		< 1000 V _{RMS}	-	I-III	-
	Climatic Classification	-	40/100/21	-	
	Pollution Degree (DIN VDE 0110/1.89)	-	2	-	
CTI	Comparative Tracking Index (DIN IEC 112/VDE 0303 Part 1)	600	-	-	
V _{PR}	Input-to-Output Test Voltage, Method b, V _{IORM} × 1.875 = V _{PR} , 100% Production Test with t _m = 1 s, Partial Discharge < 5 pC	3750	-	-	V _{peak}
	Input-to-Output Test Voltage, Method a, V _{IORM} × 1.6 = V _{PR} , Type and Sample Test with t _m = 10 s, Partial Discharge < 5 pC	3200	-	-	V _{peak}
V _{IORM}	Maximum Working Insulation Voltage	2000	-	-	V _{peak}
V _{IOTM}	Highest Allowable Over Voltage	8000	-	-	V _{peak}
E _{CR}	External Creepage	8.0	-	-	mm
E _{CL}	External Clearance	8.0	-	-	mm
DTI	Insulation Thickness	0.50	-	-	mm
T _{Case}	Safety Limit Values – Maximum Values in Failure; Case Temperature	150	-	-	°C
P _{S,INPUT}	Safety Limit Values – Maximum Values in Failure; Input Power	100	-	-	mW
P _{S,OUTPUT}	Safety Limit Values – Maximum Values in Failure; Output Power	600	-	-	mW
R _{IO}	Insulation Resistance at TS, V _{IO} = 500 V	10 ⁹	-	-	Ω

NCID9401, NCID9411

ABSOLUTE MAXIMUM RATINGS ($T_A = 25^\circ\text{C}$ unless otherwise specified)

Symbol	Parameter	Value	Unit
T_{STG}	Storage Temperature	-55 to +150	$^\circ\text{C}$
T_{OPR}	Operating Temperature	-40 to +125	$^\circ\text{C}$
T_J	Junction Temperature	-40 to +150	$^\circ\text{C}$
T_{SOL}	Lead Solder Temperature (Refer to Reflow Temperature Profile)	260 for 10 s	$^\circ\text{C}$
V_{DD}	Supply Voltage (V_{DDx})	-0.5 to 6	V
V	Voltage (V_{INx} , V_{Ox} , ENx)	-0.5 to 6	V
I_O	Average Output Current	15	mA
PD	Power Dissipation	210	mW

Stresses exceeding those listed in the Maximum Ratings table may damage the device. If any of these limits are exceeded, device functionality should not be assumed, damage may occur and reliability may be affected.

RECOMMENDED OPERATING RANGES

Symbol	Parameter	Min	Max	Unit
T_A	Ambient Operating Temperature	-40	+125	$^\circ\text{C}$
V_{DD1} V_{DD2}	Supply Voltage (Notes 3, 4)	2.5	5.5	V
V_{INH}	High Level Input Voltage	$0.7 \times V_{DD1}$	V_{DD1}	V
V_{INL}	Low Level Input Voltage	0	$0.1 \times V_{DD1}$	V
V_{UVLO+}	Supply Voltage UVLO Rising Threshold	2.2	-	V
V_{UVLO-}	Supply Voltage UVLO Falling Threshold	2.0	-	V
$UVLO_{HYS}$	Supply Voltage UVLO Hysteresis	0.1	-	V
I_{OH}	High Level Output Current	-2	-	mA
I_{OL}	Low Level Output Current	-	2	mA
DR	Signaling Rate	0	10	Mbps

Functional operation above the stresses listed in the Recommended Operating Ranges is not implied. Extended exposure to stresses beyond the Recommended Operating Ranges limits may affect device reliability.

- During power up or down, ensure that both the input and output supply voltages reach the proper recommended operating voltages to avoid any momentary instability at the output state.
- For reliable operation at recommended operating conditions, V_{DD} supply pins require at least a pair of external bypass capacitors, placed within 2 mm from V_{DD} pins 1 and 16 and GND pins 2 and 15. Recommended values are 0.1 μF and 1 μF .

ISOLATION CHARACTERISTICS

Apply over all recommended conditions. All typical values are measured at $T_A = 25^\circ\text{C}$.

Symbol	Parameter	Conditions	Min	Typ	Max	Unit
V_{ISO}	Input-Output Isolation Voltage	$T_A = 25^\circ\text{C}$, Relative Humidity < 50%, $t = 1.0$ minute, $I_{I-O} \leq 10 \mu\text{A}$, 50 Hz (Notes 5, 6, 7)	5000	-	-	V_{RMS}
R_{ISO}	Isolation Resistance	$V_{I-O} = 500$ V (Note 5)	-	10^{11}	-	
C_{ISO}	Isolation Capacitance	$V_{I-O} = 0$ V, Frequency = 1.0 MHz (Note 5)	-	1	-	pF

- Device is considered a two-terminal device: pins 1 to 8 are shorted together and pins 9 to 16 are shorted together.
- 5,000 V_{RMS} for 1-minute duration is equivalent to 6,000 V_{RMS} for 1-second duration.
- The input-output isolation voltage is a dielectric voltage rating per UL1577. It should not be regarded as an input-output continuous voltage rating. For the continuous working voltage rating, refer to equipment-level safety specification or DIN VDE V 0884-11 Safety and Insulation Ratings Table on page 4.

NCID9401, NCID9411

ELECTRICAL CHARACTERISTICS

Apply over all recommended conditions, $T_A = -40^{\circ}\text{C}$ to $+125^{\circ}\text{C}$, $V_{DD1} = V_{DD2} = 2.5\text{ V}$ to 5.5 V , unless otherwise specified. All typical values are measured at $T_A = 25^{\circ}\text{C}$.

Symbol	Parameter	Conditions	Min	Typ	Max	Unit	Figure
V_{OH}	High Level Output Voltage	$V_{DD} = 5\text{ V}$, $I_{OH} = -4\text{ mA}$	$V_{DDO} - 0.4$	$V_{DDO} - 0.1$	-	V	11
		$V_{DD} = 3.3\text{ V}$, $I_{OH} = -2\text{ mA}$					
		$V_{DD} = 2.5\text{ V}$, $I_{OH} = -1\text{ mA}$					
V_{OL}	Low Level Output Voltage	$V_{DD} = 5\text{ V}$, $I_{OL} = 4\text{ mA}$	-	0.1	0.4	V	12
		$V_{DD} = 3.3\text{ V}$, $I_{OL} = 2\text{ mA}$					
		$V_{DD} = 2.5\text{ V}$, $I_{OL} = 1\text{ mA}$					
V_{INT+}	Rising Input Voltage Threshold		-	-	$0.7 \times V_{DD1}$	V	
V_{INT-}	Falling Input Voltage Threshold		$0.1 \times V_{DD1}$	-	-	V	
$V_{INT(HYS)}$	Input Threshold Voltage Hysteresis		$0.1 \times V_{DD1}$	$0.2 \times V_{DD1}$	-	V	
I_{INH}	High Level Input Current	$V_{IH} = V_{DD1}$	-	-	1	μA	
I_{INL}	Low Level Input Current	$V_{IL} = 0\text{ V}$	-1	-	-	μA	
CMTI	Common Mode Transient Immunity	$V_I = V_{DD1}$ or 0 V , $V_{CM} = 1500\text{ V}$	100	150	-	$\text{kV}/\mu\text{s}$	16
C_{IN}	Input Capacitance	$V_{IN} = V_{DD1}/2 + 0.4 \times \sin(2\pi ft)$, $f = 1\text{ MHz}$, $V_{DD} = 5\text{ V}$	-	2	-	pF	

Product parametric performance is indicated in the Electrical Characteristics for the listed test conditions, unless otherwise noted. Product performance may not be indicated by the Electrical Characteristics if operated under different conditions.

SUPPLY CURRENT CHARACTERISTICS

Apply over all recommended conditions, $T_A = -40^{\circ}\text{C}$ to $+125^{\circ}\text{C}$ unless otherwise specified. All typical values are measured at $T_A = 25^{\circ}\text{C}$.

Symbol	Parameter	Conditions	Min	Typ	Max	Unit	Figure
I_{DD1}	DC Supply Current	$V_{DD} = 5\text{ V}$, $EN = 0/5\text{ V}$, $V_{IN} = 0/5\text{ V}$	-	8.3	11.3	mA	
I_{DD2}				9.3	12.3		
I_{DD1}		$V_{DD} = 3.3\text{ V}$, $EN = 0/3.3\text{ V}$, $V_{IN} = 0/3.3\text{ V}$		8.0	11		
I_{DD2}				9.1	12		
I_{DD1}		$V_{DD} = 2.5\text{ V}$, $EN = 0/2.5\text{ V}$, $V_{IN} = 0/2.5\text{ V}$		7.9	10.8		
I_{DD2}				9.0	11.8		
I_{DD1}	AC Supply Current 1 Mbps	$V_{DD} = 5\text{ V}$, $EN = 5\text{ V}$, $C_L = 15\text{ pF}$, $V_{IN} = 5\text{ V}$ Square Wave	-	8.4	11.3	mA	3, 4, 5, 6
I_{DD2}				9.5	12.3		
I_{DD1}		$V_{DD} = 3.3\text{ V}$, $EN = 3.3\text{ V}$, $C_L = 15\text{ pF}$, $V_{IN} = 3.3\text{ V}$ Square Wave		8.1	11		
I_{DD2}				9.2	12		
I_{DD1}		$V_{DD} = 2.5\text{ V}$, $EN = 2.5\text{ V}$, $C_L = 15\text{ pF}$, $V_{IN} = 2.5\text{ V}$ Square Wave		8.0	10.8		
I_{DD2}				9.1	11.8		
I_{DD1}	AC Supply Current 10 Mbps	$V_{DD} = 5\text{ V}$, $EN = 5\text{ V}$, $C_L = 15\text{ pF}$, $V_{IN} = 5\text{ V}$ Square Wave	-	8.9	12.6	mA	
I_{DD2}				11.3	13.6		
I_{DD1}		$V_{DD} = 3.3\text{ V}$, $EN = 3.3\text{ V}$, $C_L = 15\text{ pF}$, $V_{IN} = 3.3\text{ V}$ Square Wave		8.4	11.7		
I_{DD2}				10.2	12.7		
I_{DD1}		$V_{DD} = 2.5\text{ V}$, $EN = 2.5\text{ V}$, $C_L = 15\text{ pF}$, $V_{IN} = 2.5\text{ V}$ Square Wave		8.2	11.3		
I_{DD2}				9.8	12.3		

NCID9401, NCID9411

SWITCHING CHARACTERISTICS – NCID9401

Apply over all recommended conditions, $T_A = -40^{\circ}\text{C}$ to $+125^{\circ}\text{C}$ unless otherwise specified. All typical values are measured at $T_A = 25^{\circ}\text{C}$.

Symbol	Parameter	Ch	Conditions	Min	Typ	Max	Unit	Figure
t_{PHL}	Propagation Delay to Logic Low Output (Note 8)	All	$V_{DD} = 5\text{ V}, C_L = 15\text{ pF}$	-	136	200	ns	8, 13
			$V_{DD} = 3.3\text{ V}, C_L = 15\text{ pF}$					
			$V_{DD} = 2.5\text{ V}, C_L = 15\text{ pF}$					
t_{PLH}	Propagation Delay to Logic High Output (Note 9)	All	$V_{DD} = 5\text{ V}, C_L = 15\text{ pF}$	-	137	200	ns	
			$V_{DD} = 3.3\text{ V}, C_L = 15\text{ pF}$					
			$V_{DD} = 2.5\text{ V}, C_L = 15\text{ pF}$					
PWD	Pulse Width Distortion $ t_{PHL} - t_{PLH} $ (Note 10)	All	$V_{DD} = 5\text{ V}, C_L = 15\text{ pF}$	-	33	80	ns	
			$V_{DD} = 3.3\text{ V}, C_L = 15\text{ pF}$					
			$V_{DD} = 2.5\text{ V}, C_L = 15\text{ pF}$					
$t_{PSK(PP)}$	Propagation Delay Skew (Part to Part) (Note 11)	All	$V_{DD} = 5\text{ V}, C_L = 15\text{ pF}$	-80	-	80	ns	
			$V_{DD} = 3.3\text{ V}, C_L = 15\text{ pF}$					
			$V_{DD} = 2.5\text{ V}, C_L = 15\text{ pF}$					
t_R	Output Rise Time (10% to 90%)	All	$V_{DD} = 5\text{ V}, C_L = 15\text{ pF}$	-	3	-	ns	
			$V_{DD} = 3.3\text{ V}, C_L = 15\text{ pF}$					
			$V_{DD} = 2.5\text{ V}, C_L = 15\text{ pF}$					
t_F	Output Fall Time (90% to 10%)	All	$V_{DD} = 5\text{ V}, C_L = 15\text{ pF}$	-	2	-	ns	
			$V_{DD} = 3.3\text{ V}, C_L = 15\text{ pF}$					
			$V_{DD} = 2.5\text{ V}, C_L = 15\text{ pF}$					
t_{PZL}	High Impedance to Logic Low Output Delay (Note 12)	All	$V_{DD} = 5\text{ V}, R_L = 1\text{ k}\Omega$	-	8.4	25	ns	14
			$V_{DD} = 3.3\text{ V}, R_L = 1\text{ k}\Omega$		9.9			
			$V_{DD} = 2.5\text{ V}, R_L = 1\text{ k}\Omega$		12.3			
t_{PLZ}	Logic Low to High Impedance Output Delay (Note 13)	All	$V_{DD} = 5\text{ V}, R_L = 1\text{ k}\Omega$	-	10.8	25	ns	
			$V_{DD} = 3.3\text{ V}, R_L = 1\text{ k}\Omega$		14.5			
			$V_{DD} = 2.5\text{ V}, R_L = 1\text{ k}\Omega$		17.8			
t_{PZH}	High Impedance to Logic High Output Delay (Note 14)	All	$V_{DD} = 5\text{ V}, R_L = 1\text{ k}\Omega$	-	0.53	1	μs	15
			$V_{DD} = 3.3\text{ V}, R_L = 1\text{ k}\Omega$		0.50			
			$V_{DD} = 2.5\text{ V}, R_L = 1\text{ k}\Omega$		0.50			
t_{PHZ}	Logic High to High Impedance Output Delay (Note 15)	All	$V_{DD} = 5\text{ V}, R_L = 1\text{ k}\Omega$	-	11.7	25	ns	
			$V_{DD} = 3.3\text{ V}, R_L = 1\text{ k}\Omega$		13.1			
			$V_{DD} = 2.5\text{ V}, R_L = 1\text{ k}\Omega$		15.0			

8. Propagation delay t_{PHL} is measured from the 50% level of the falling edge of the input pulse to the 50% level of the falling edge of the V_O signal.
9. Propagation delay t_{PLH} is measured from the 50% level of the rising edge of the input pulse to the 50% level of the rising edge of the V_O signal.
10. PWD is defined as $|t_{PHL} - t_{PLH}|$ for any given device.
11. Part-to-part propagation delay skew is the difference between the measured propagation delay times of a specified channel of any two parts at identical operating conditions and equal load.
12. Enable delay t_{PZL} is measured from the 50% level of the rising edge of the EN pulse to the 50% of the falling edge of the V_O signal as it switches from high impedance state to low state.
13. Disable delay t_{PLZ} is measured from the 50% level of the falling edge of the EN pulse to 0.5 V level of the rising edge of the V_O signal as it switches from low state to high impedance state.
14. Enable delay t_{PZH} is measured from the 50% level of the rising edge of the EN pulse to the 50% of the rising edge of the V_O signal as it switches from high impedance state to high state.
15. Disable delay t_{PHZ} is measured from the 50% level of the falling edge of the EN pulse to $V_{OH} - 0.5\text{ V}$ level of the falling edge of the V_O signal as it switches from high state to high impedance state.

NCID9401, NCID9411

SWITCHING CHARACTERISTICS – NCID9411

Apply over all recommended conditions, $T_A = -40^{\circ}\text{C}$ to $+125^{\circ}\text{C}$ unless otherwise specified. All typical values are measured at $T_A = 25^{\circ}\text{C}$.

Symbol	Parameter	Ch	Conditions	Min	Typ	Max	Unit	Figure	
t_{PHL}	Propagation Delay to Logic Low Output (Note 8)	A, B, C	$V_{DD} = 5\text{ V}, C_L = 15\text{ pF}$	-	115	170	ns	9, 10, 13	
			$V_{DD} = 3.3\text{ V}, C_L = 15\text{ pF}$						
			$V_{DD} = 2.5\text{ V}, C_L = 15\text{ pF}$						
		D	$V_{DD} = 5\text{ V}, C_L = 15\text{ pF}$	-	77	110	ns		
			$V_{DD} = 3.3\text{ V}, C_L = 15\text{ pF}$						
			$V_{DD} = 2.5\text{ V}, C_L = 15\text{ pF}$						
t_{PLH}	Propagation Delay to Logic High Output (Note 9)	A,B,C	$V_{DD} = 5\text{ V}, C_L = 15\text{ pF}$	-	117	170	ns		
			$V_{DD} = 3.3\text{ V}, C_L = 15\text{ pF}$						
			$V_{DD} = 2.5\text{ V}, C_L = 15\text{ pF}$						
		D	$V_{DD} = 5\text{ V}, C_L = 15\text{ pF}$	-	78	110	ns		
			$V_{DD} = 3.3\text{ V}, C_L = 15\text{ pF}$						
			$V_{DD} = 2.5\text{ V}, C_L = 15\text{ pF}$						
PWD	Pulse Width Distortion $ t_{PHL} - t_{PLH} $ (Note 10)	A,B,C	$V_{DD} = 5\text{ V}, C_L = 15\text{ pF}$	-70	26	70	ns		
			$V_{DD} = 3.3\text{ V}, C_L = 15\text{ pF}$						
			$V_{DD} = 2.5\text{ V}, C_L = 15\text{ pF}$						
		D	$V_{DD} = 5\text{ V}, C_L = 15\text{ pF}$	-40	13	40	ns		
			$V_{DD} = 3.3\text{ V}, C_L = 15\text{ pF}$						
			$V_{DD} = 2.5\text{ V}, C_L = 15\text{ pF}$						
$t_{PSK(PP)}$	Propagation Delay Skew (Part to Part) (Note 11)	All	$V_{DD} = 5\text{ V}, C_L = 15\text{ pF}$	-70	-	70	ns		
			$V_{DD} = 3.3\text{ V}, C_L = 15\text{ pF}$						
			$V_{DD} = 2.5\text{ V}, C_L = 15\text{ pF}$						
t_R	Output Rise Time (10% to 90%)	All	$V_{DD} = 5\text{ V}, C_L = 15\text{ pF}$	-	3	-	ns		
			$V_{DD} = 3.3\text{ V}, C_L = 15\text{ pF}$						
			$V_{DD} = 2.5\text{ V}, C_L = 15\text{ pF}$						
t_F	Output Fall Time (90% to 10%)	All	$V_{DD} = 5\text{ V}, C_L = 15\text{ pF}$	-	2	-	ns		
			$V_{DD} = 3.3\text{ V}, C_L = 15\text{ pF}$						
			$V_{DD} = 2.5\text{ V}, C_L = 15\text{ pF}$						
t_{PZL}	High Impedance to Logic Low Output Delay (Note 12)	All	$V_{DD} = 5\text{ V}, R_L = 1\text{ k}\Omega$	-	8.5	25	ns	14	
			$V_{DD} = 3.3\text{ V}, R_L = 1\text{ k}\Omega$		10.2				
			$V_{DD} = 2.5\text{ V}, R_L = 1\text{ k}\Omega$		12.6				
t_{PLZ}	Logic Low to High Impedance Output Delay (Note 13)	All	$V_{DD} = 5\text{ V}, R_L = 1\text{ k}\Omega$	-	10.8	25	ns		
			$V_{DD} = 3.3\text{ V}, R_L = 1\text{ k}\Omega$		14.6				
			$V_{DD} = 2.5\text{ V}, R_L = 1\text{ k}\Omega$		17.8				
t_{PZH}	High Impedance to Logic High Output Delay (Note 14)	All	$V_{DD} = 5\text{ V}, R_L = 1\text{ k}\Omega$	-	0.54	1	μs	15	
			$V_{DD} = 3.3\text{ V}, R_L = 1\text{ k}\Omega$		0.50				
			$V_{DD} = 2.5\text{ V}, R_L = 1\text{ k}\Omega$		0.50				
t_{PHZ}	Logic High to High Impedance Output Delay (Note 15)	All	$V_{DD} = 5\text{ V}, R_L = 1\text{ k}\Omega$	-	11.6	25	ns		
			$V_{DD} = 3.3\text{ V}, R_L = 1\text{ k}\Omega$		12.9				
			$V_{DD} = 2.5\text{ V}, R_L = 1\text{ k}\Omega$		14.6				

NCID9401, NCID9411

TYPICAL PERFORMANCE CHARACTERISTICS

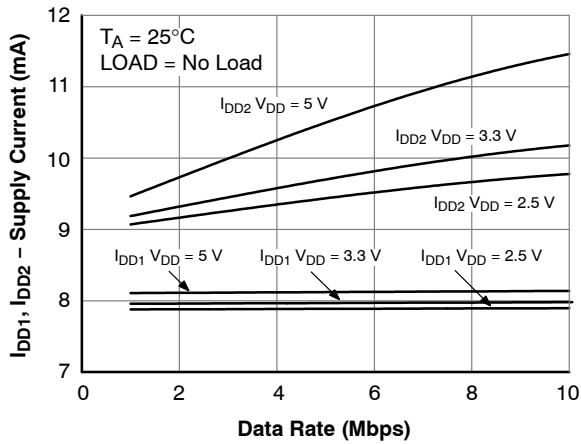

Figure 3. NCID9401 Supply Current vs. Data Rate (No Load)

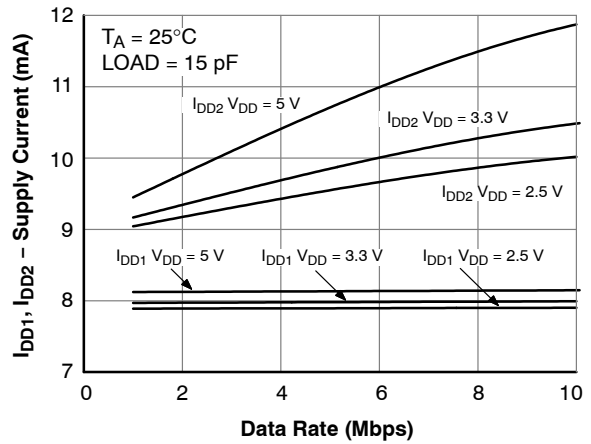

Figure 4. NCID9401 Supply Current vs. Data Rate (Load = 15 pF)

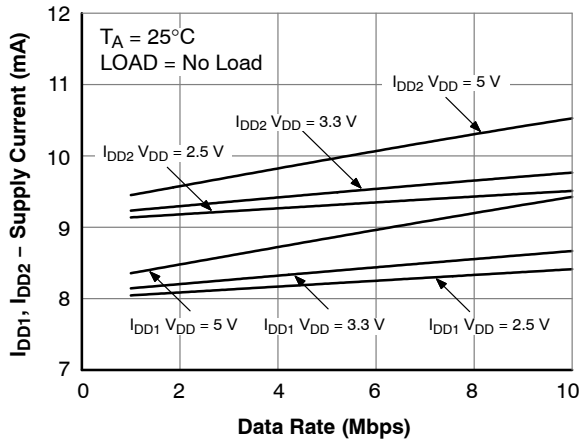

Figure 5. NCID9411 Supply Current vs. Data Rate (No Load)

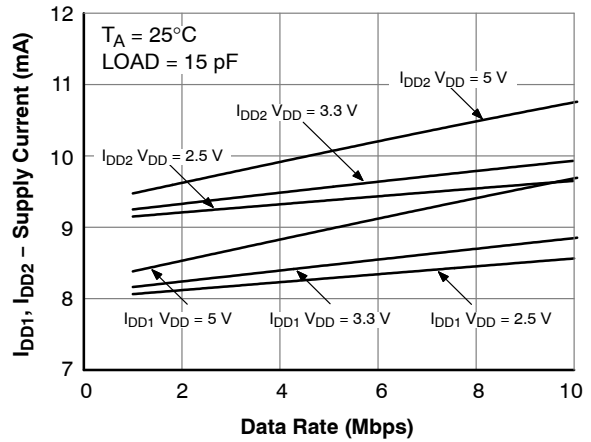

Figure 6. NCID9411 Supply Current vs. Data Rate (Load = 15 pF)

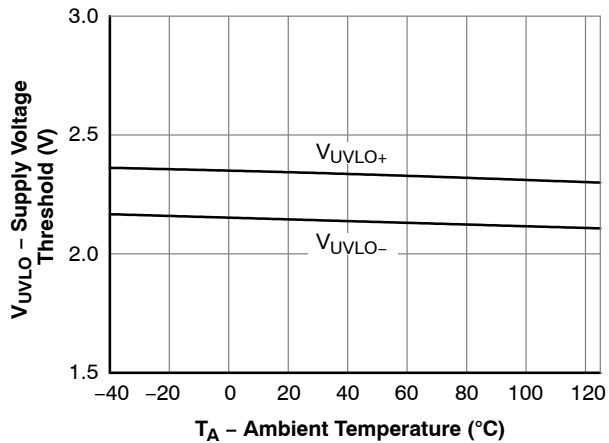

Figure 7. Supply Voltage UVLO Threshold vs. Ambient Temperature

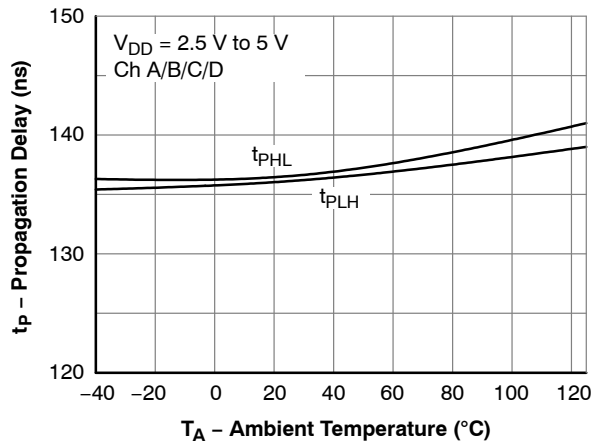

Figure 8. NCID9401 Propagation Delay vs. Ambient Temperature

NCID9401, NCID9411

TYPICAL PERFORMANCE CHARACTERISTICS (Continued)

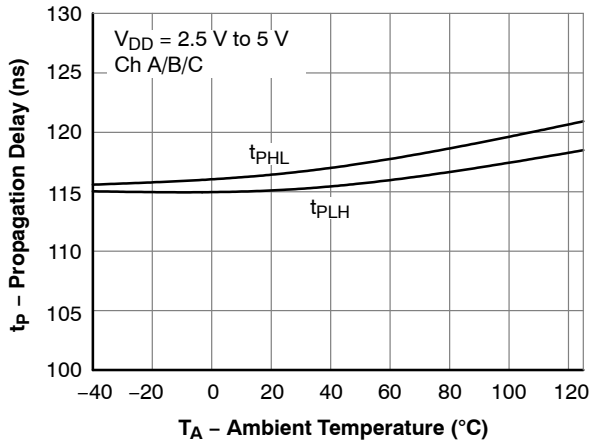

Figure 9. NCID9411 Channel A/B/C Propagation Delay vs. Ambient Temperature

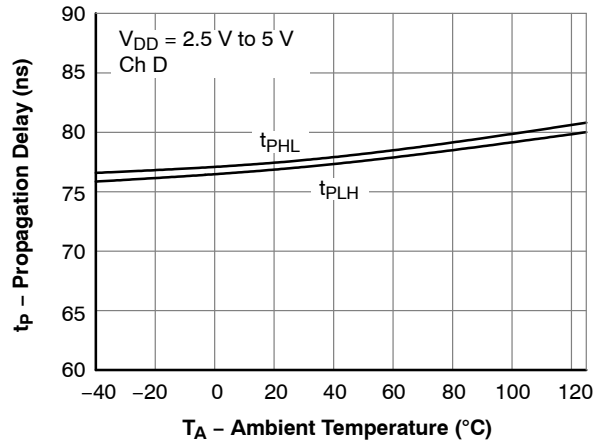

Figure 10. NCID9411 Channel D Propagation Delay vs. Ambient Temperature

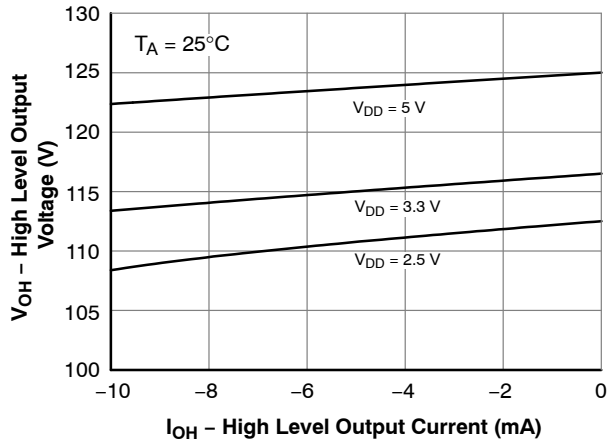

Figure 11. High Level Output Voltage vs. Current

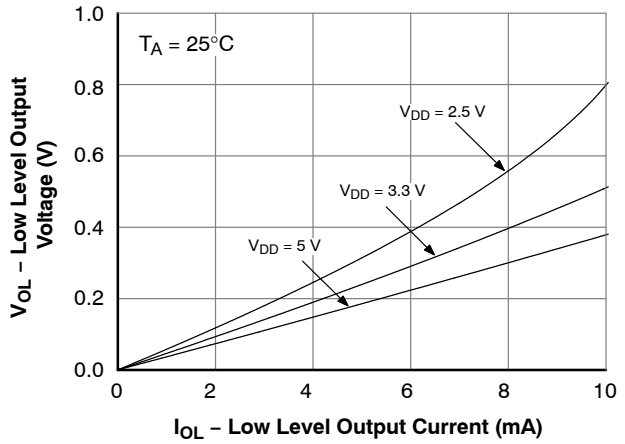

Figure 12. Low Level Output Voltage vs. Current

TEST CIRCUITS

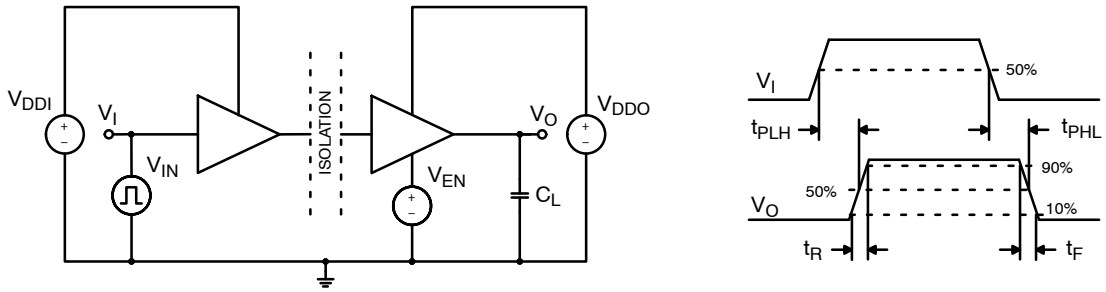

Figure 13. V_{IN} to V_O Propagation Delay Test Circuit and Waveform

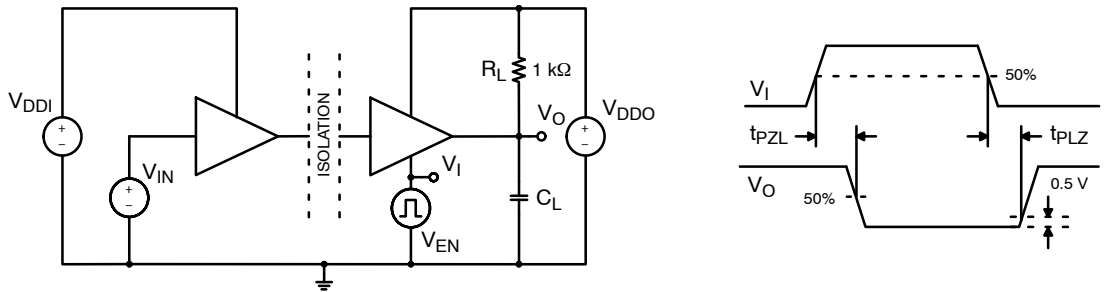

Figure 14. EN to Logic Low V_O Propagation Delay Test Circuit and Waveform

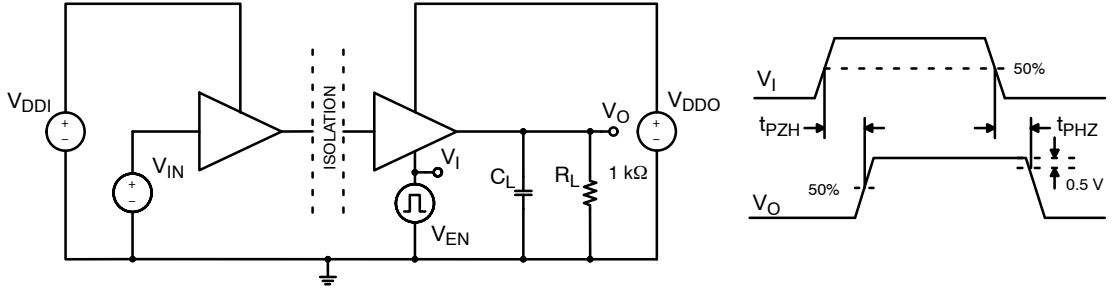

Figure 15. EN to Logic High V_O Propagation Delay Test Circuit and Waveform

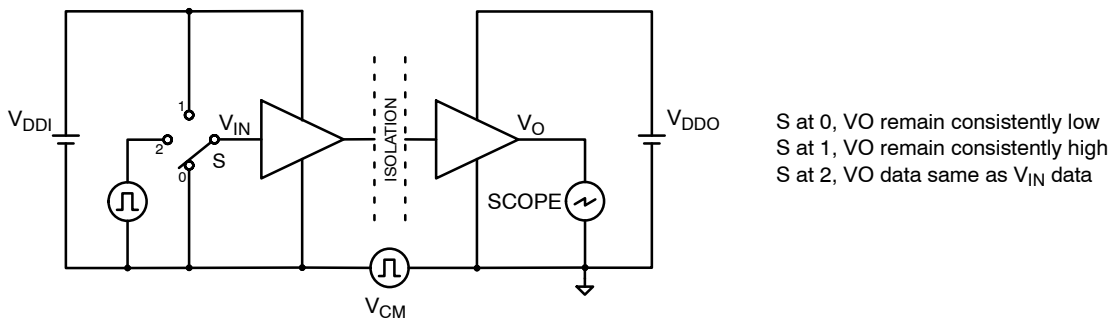

Figure 16. Common Mode Transient Immunity Test Circuit

APPLICATION INFORMATION

Theory of Operation

NCID9401 and NCID9411 are quad-channel digital isolators. Each channel enables communication between two isolated circuits. It uses off-chip ceramic capacitors that serve both as the isolation barrier and as the medium of transmission for signal switching using On-Off keying (OOK) technique, illustrated in the single channel operational block diagram in Figure 17.

At the transmitter side, the V_{IN} input logic state is modulated with a high frequency carrier signal. The resulting signal is amplified and transmitted to the isolation barrier. The receiver side detects the barrier signal and demodulates it using an envelope detection technique. The output signal determines the V_O output logic state when the output enable control EN is at high. When EN is at low, output V_O is at high impedance state. V_O is at default state low when the power supply at the transmitter side is turned off or the input V_{IN} is disconnected.

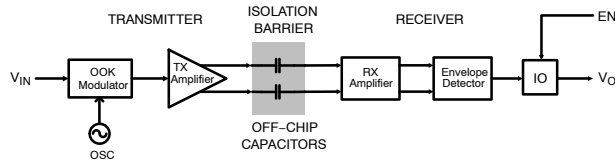

Figure 17. Operational Block Diagram of Single Channel

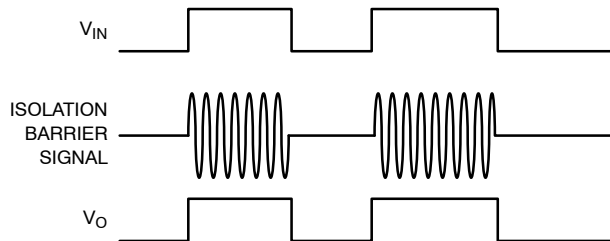

Figure 18. On-Off Keying Modulation Signals

Layout Recommendation

Layout of the digital circuits relies on good suppression of unwanted noise and electromagnetic interference. It is recommended to use 4-layer FR4 PCB, with ground plane below the components, power plane below the ground plane, signal lines and power fill on top, and signal lines and ground fill at the bottom. The alternating polarities of the layers creates interplane capacitances that aids the bypass capacitors required for reliable operation at digital switching rates.

In the layout with digital isolators, it is required that the isolated circuits have separate ground and power planes. The section below the device should be clear with no power, ground or signal traces. Maintain a gap equal to or greater than the specified minimum creepage clearance of the device package.

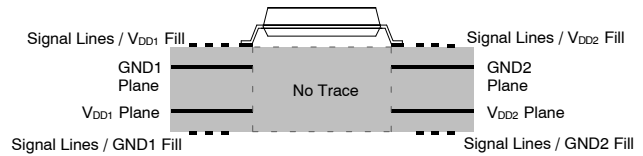

Figure 19. 4-Layer PCB for Digital Isolator

It is highly advised to connect at least a pair of low ESR supply bypass capacitors, placed within 2mm from the power supply pins 1 and 16 and ground pins 2 and 15. Recommended values are 1 μF and 0.1 μF , respectively. Place them between the V_{DD} pins of the device and the via to the power planes, with the higher frequency, lower value capacitor closer to the device pins. Directly connect the device ground pins 2, 8, 9 and 15 by via to their corresponding ground planes.

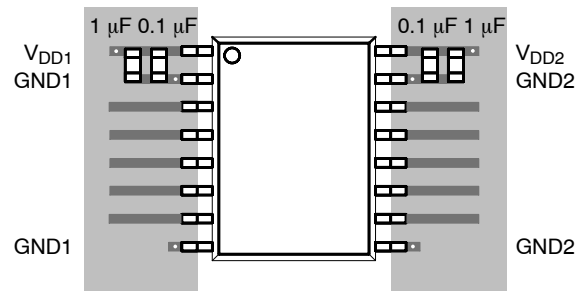

Figure 20. Placement of Bypass Capacitors

Over Temperature Detection

NCID9401 and NCID9411 have built-in Over Temperature Detection (OTD) feature that protects the IC from thermal damage. The output pins will automatically switch to default state when the ambient temperature exceeds the maximum junction temperature at threshold of approximately 160°C. The device will return to normal operation when the temperature decreases approximately 20°C below the OTD threshold.

NCID9401, NCID9411

ORDERING INFORMATION

Part Number	Grade	Package	Shipping [†]
NCID9401	Industrial	SOIC16 W	50 Units / Tube
NCID9401R2	Industrial	SOIC16 W	750 Units / Tape & Reel
NCID9411	Industrial	SOIC16 W	50 Units / Tube
NCID9411R2	Industrial	SOIC16 W	750 Units / Tape & Reel
NCIV9401* (pending)	Automotive	SOIC16 W	50 Units / Tube
NCIV9401R2* (pending)	Automotive	SOIC16 W	750 Units / Tape & Reel
NCIV9411* (pending)	Automotive	SOIC16 W	50 Units / Tube
NCIV9411R2* (pending)	Automotive	SOIC16 W	750 Units / Tape & Reel

[†]For information on tape and reel specifications, including part orientation and tape sizes, please refer to our Tape and Reel Packaging Specifications Brochure, BRD8011/D.

*NCIV Prefix for Automotive and Other Applications Requiring Unique Site and Control Change Requirements; AEC-Q100 Qualified and PPAP Capable.

NCID9401, NCID9411

ON Semiconductor is licensed by the Philips Corporation to carry the I²C bus protocol.

ON Semiconductor and  are trademarks of Semiconductor Components Industries, LLC dba ON Semiconductor or its subsidiaries in the United States and/or other countries. ON Semiconductor owns the rights to a number of patents, trademarks, copyrights, trade secrets, and other intellectual property. A listing of ON Semiconductor's product/patent coverage may be accessed at www.onsemi.com/site/pdf/Patent-Marking.pdf. ON Semiconductor reserves the right to make changes without further notice to any products herein. ON Semiconductor makes no warranty, representation or guarantee regarding the suitability of its products for any particular purpose, nor does ON Semiconductor assume any liability arising out of the application or use of any product or circuit, and specifically disclaims any and all liability, including without limitation special, consequential or incidental damages. Buyer is responsible for its products and applications using ON Semiconductor products, including compliance with all laws, regulations and safety requirements or standards, regardless of any support or applications information provided by ON Semiconductor. "Typical" parameters which may be provided in ON Semiconductor data sheets and/or specifications can and do vary in different applications and actual performance may vary over time. All operating parameters, including "Typicals" must be validated for each customer application by customer's technical experts. ON Semiconductor does not convey any license under its patent rights nor the rights of others. ON Semiconductor products are not designed, intended, or authorized for use as a critical component in life support systems or any FDA Class 3 medical devices or medical devices with a same or similar classification in a foreign jurisdiction or any devices intended for implantation in the human body. Should Buyer purchase or use ON Semiconductor products for any such unintended or unauthorized application, Buyer shall indemnify and hold ON Semiconductor and its officers, employees, subsidiaries, affiliates, and distributors harmless against all claims, costs, damages, and expenses, and reasonable attorney fees arising out of, directly or indirectly, any claim of personal injury or death associated with such unintended or unauthorized use, even if such claim alleges that ON Semiconductor was negligent regarding the design or manufacture of the part. ON Semiconductor is an Equal Opportunity/Affirmative Action Employer. This literature is subject to all applicable copyright laws and is not for resale in any manner.

PUBLICATION ORDERING INFORMATION

LITERATURE FULFILLMENT:

Email Requests to: orderlit@onsemi.com

ON Semiconductor Website: www.onsemi.com

TECHNICAL SUPPORT

North American Technical Support:
Voice Mail: 1 800-282-9855 Toll Free USA/Canada
Phone: 011 421 33 790 2910

Europe, Middle East and Africa Technical Support:

Phone: 00421 33 790 2910

For additional information, please contact your local Sales Representative