









Ficha técnica

Rueda H-BP 1-0238

Codigo				Tipo cojinete Eje					
1-0238	25	10	11	—	50x33	38x20	5	40	33



Características

Fabricada con chapa de acero hasta 2 mm de espesor.
Acabado cincado brillante.
Múltiples fijaciones: platina, agujero pasante, fijación para cantos, capuchón para mimbre.
Cojinete liso.

Datos técnicos

Diámetro: 25 mm
Carga: 10 kg
Tipo de cojinete: Cojinete Liso
Ancho de Banda de rodadura: 11 mm
Medidas de placa superior: 50x33 mm
Distancia entre agujeros: 38x20 mm
Diámetro agujero sujeción platina: 5 mm
Altura total: 40 mm
Radio de giro: 33 mm

Archivos CAD

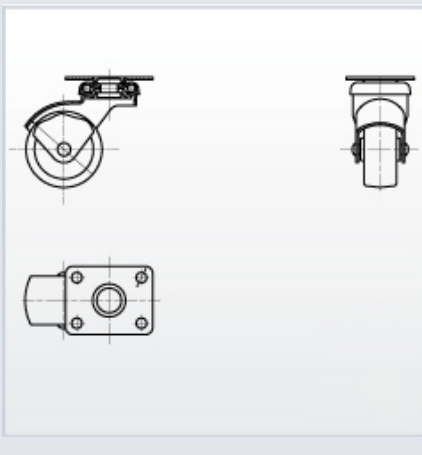
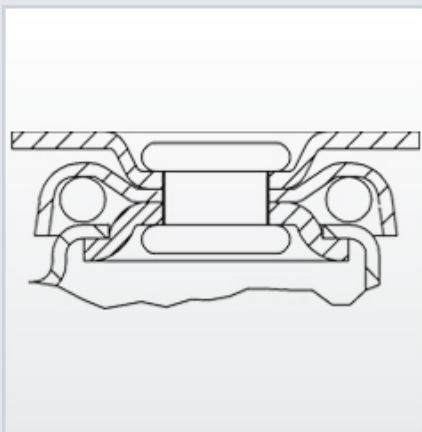

Rueda

BP (Polipropileno-Plástico)
Rueda de polipropileno gris
Rango de temperatura: -20° ÷ +60°