

Products Catalog

**Conductive Polymer Aluminum
Electrolytic Capacitors
SP-Cap**

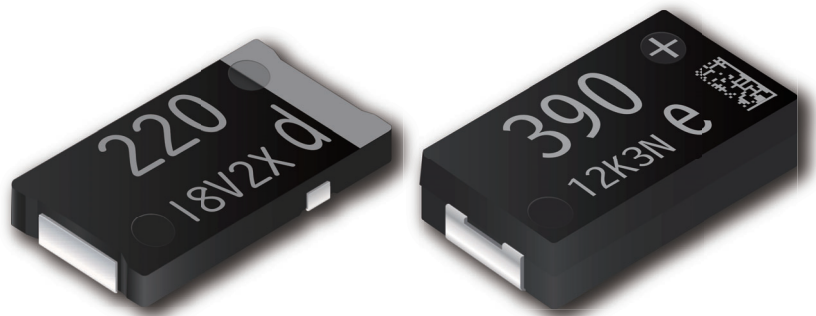

**IN Your
Future**



Conductive Polymer Aluminum Electrolytic Capacitors INDEX

Item		Page
Guidelines and precautions		1
Selection guide	Line-up	6
	Diagram	7
	Explanation of part numbers	8
	Mounting specifications	9
	Packing specifications	10
Series	CS,CT,CX : High voltage, Low profile	11
	SX : Large capacitance, Low ESR	14
	GX/GX-L : Large capacitance, Super low ESR	16
	LX : Large capacitance, Low ESR	18
	SR,LR,SS,LS,ST,LT : Low profile, Low ESR	20
	GY : Super low ESR, Large capacitance	22
	CY,SY : Endurance 85 °C 2000 h	23
	NEW JX : Endurance 125 °C 3000 h	25
	HX : Endurance 125 °C 1000 h	27
Replacement list for “Not recommended for new design”		29

Guidelines and precautions regarding the technical information and use of our products described in this online catalog.

- If you want to use our products described in this online catalog for applications requiring special qualities or reliability, or for applications where the failure or malfunction of the products may directly jeopardize human life or potentially cause personal injury (e.g. aircraft and aerospace equipment, traffic and transportation equipment, combustion equipment, medical equipment, accident prevention, anti-crime equipment, and/or safety equipment), it is necessary to verify whether the specifications of our products fit to such applications. Please ensure that you will ask and check with our inquiry desk as to whether the specifications of our products fit to such applications use before you use our products.
- The quality and performance of our products as described in this online catalog only apply to our products when used in isolation. Therefore, please ensure you evaluate and verify our products under the specific circumstances in which our products are assembled in your own products and in which our products will actually be used.
- If you use our products in equipment that requires a high degree of reliability, regardless of the application, it is recommended that you set up protection circuits and redundancy circuits in order to ensure safety of your equipment.
- The products and product specifications described in this online catalog are subject to change for improvement without prior notice. Therefore, please be sure to request and confirm the latest product specifications which explain the specifications of our products in detail, before you finalize the design of your applications, purchase, or use our products.
- The technical information in this online catalog provides examples of our products' typical operations and application circuits. We do not guarantee the non-infringement of third party's intellectual property rights and we do not grant any license, right, or interest in our intellectual property.
- If any of our products, product specifications and/or technical information in this online catalog is to be exported or provided to non-residents, the laws and regulations of the exporting country, especially with regard to security and export control, shall be observed.

<Regarding the Certificate of Compliance with the EU RoHS Directive/REACH Regulations>

- The switchover date for compliance with the RoHS Directive/REACH Regulations varies depending on the part number or series of our products.
- When you use the inventory of our products for which it is unclear whether those products are compliant with the RoHS Directive/REACH Regulation, please select "Sales Inquiry" in the website inquiry form and contact us.

We do not take any responsibility for the use of our products outside the scope of the specifications, descriptions, guidelines and precautions described in this online catalog.

Notices

■ Applicable laws and regulations

- This product complies with the RoHS Directive (Restriction of the use of certain hazardous substances in electrical and electronic equipment (DIRECTIVE 2011/65/EU and (EU)2015/863)).
- No Ozone Depleting Chemicals(ODC's), controlled under the Montreal Protocol Agreement, are used in producing this product. We do not use PBBs or PBDEs as brominated flame retardants.
- Export procedure which followed export related regulations, such as foreign exchange and a foreign trade method, on the occasion of export of this product.
- These products are not dangerous goods on the transportation as identified by UN(United Nations) numbers or UN classification.

■ Limited applications

- This capacitor is designed to be used for electronics circuits such as audio/visual equipment, home appliances, computers and other office equipment, optical equipment, measuring equipment.
- Prior to usage of this capacitor for applications requiring high reliability and safety and malfunction of capacitor might threaten human life or property, it is highly recommended to confirm the usage of this capacitors with Panasonic.

■ Intellectual property rights and licenses

- The technical information in this specification provides examples of our products' typical operations and application circuits. We do not guarantee the non-infringement of third party's intellectual property rights and we do not grant any license, right, or interest in our intellectual property.

Items to be observed

■ For specification

- This specification guarantees the quality and performance of the product as individual components. The durability differs depending on the environment and the conditions of usage. Before use, check and evaluate their compatibility with actual conditions when installed in the products. When safety requirements cannot be satisfied in your technical examination, inform us immediately.
- Do not use the products beyond the specifications described in this document.

■ Upon application to products where safety is regarded as important

Install the following systems for a fail-safe design to ensure safety if these products are to be used in equipment where a defect in these products may cause the loss of human life or other significant damage, such as damage to vehicles (automobile, train, vessel), traffic lights, medical equipment, aerospace equipment, electric heating appliances, combustion/ gas equipment, rotating rotating equipment, and disaster/crime prevention equipment.

- (1) The system is equipped with a protection circuit and protection device.
- (2) The system is equipped with a redundant circuit or other system to prevent an unsafe status in the event of a single fault.

■ Conditions of use

- Before using the products, carefully check the effects on their quality and performance, and determined whether or not they can be used. These products are designed and manufactured for general-purpose and standard use in general electronic equipment. These products are not intended for use in the following special conditions.
 - (1) In liquid, such as Water, Oil, Chemicals, or Organic solvent.
 - (2) In direct sunlight, outdoors, or in dust.
 - (3) In vapor, such as dew condensation water of resistive element, or water leakage, salty air, or air with a high concentration corrosive gas, such as Cl₂, H₂S, NH₃, SO₂, or NO_x.
 - (4) In an environment where strong static electricity or electromagnetic waves exist.
 - (5) Mounting or placing heat-generating components or inflammables, such as vinyl-coated wires, near these products.
 - (6) Sealing or coating of these products or a printed circuit board on which these products are mounted, with resin and other material.
 - (7) Using solvent, water or water-soluble cleaner for flux cleaning agent after soldering. (In particular, when using water or a water-soluble cleaning agent, be careful not to leave water residues)
 - (8) Using in the atmosphere where strays acid or alkaline.
 - (9) Using in the atmosphere where there are excessive vibration and shock.
 - (10) Using in the atmosphere where there are low pressure or decompression.
- Please arrange circuit design for preventing impulse or transitional voltage. Do not apply voltage, which exceeds the full rated voltage when the capacitors receive impulse voltage, instantaneous high voltage, high pulse voltage etc.
- Our products there is a product are using an electrolyte solution. Therefore, misuse can result in rapid deterioration of characteristics and functions of each product. Electrolyte leakage damages printed circuit and affects performance, characteristics, and functions of customer system.



Application Guidelines (SP-Cap)

1. Circuit design

1.1 Prohibited circuits for use

Do not use the SP-Cap with the following circuit.

- (1) High-impedance voltage retention circuits
- (2) Coupling circuits
- (3) Time-constant circuit
- (4) Circuit which are greatly affected by leakage current
- (5) 2 or more SP-Cap connected serially

1.2 Voltage and polarity

The application of over-voltage and reverse voltage described below can cause increases in leakage current and short circuits. Applied voltage, refers to the voltage value including the peak value of the transitional Instantaneous voltage and the peak value of ripple voltage, not just steady line voltage.

Design your circuit so that the peak voltage does not exceed the stipulated voltage.

【Over-Voltage】

Do not apply over-voltage in excess of the rated voltage. Do not apply voltage, which exceeds the full rated voltage when the SP-Cap receive impulse voltage, instantaneous high voltage, high pulse voltage etc.

【Reverse-Voltage】

Do not apply reverse-voltage

1.3 Ripple current

Use the SP-Cap within the stipulated permitted ripple current.

When excessive ripple current is applied to the SP-Cap, it causes increases in leakage current and short circuits due to self-heating.

Even when using the SP-Cap under the permissible ripple current, reverse voltage may occur if the DC bias voltage is low.

1.4 Leakage current

There is a risk of leakage current characteristics increasing even if the following use environments are within the stipulated range. However, even if the leakage current increases, the SP-Cap self-repairing function will reduce the leakage current in most cases when a voltage is applied.

- (1) After reflow
- (2) Shelf conditions such as high temperature with no load, high temperature high humidity with no load and sudden temperature changes.

1.5 Temperature

- (1) Use at or under the rated (guaranteed) temperature.

Operation at temperatures exceeding specifications causes large changes in the SP-Cap electrical properties, and deterioration than can potentially lead to failure.

When calculating the operating temperature of the SP-Cap, be sure to include not only the ambient temperature and internal temperature of the unit, but also radiation from heat generating elements inside the unit (power transistors, resistors, etc.), and self-heating due to ripple current.

- (2) Specified ESR is a value at the time of shipping from factory. ESR may change upon use conditions.

1.6 Failure rate

The majority of failure modes are short circuits or increases in leakage current.

The main factors of failure are mechanical stress, heat stress and electric stress due to re-flow and heat from the use temperature environment.

Even within the stipulated limits, it is possible to lower the failure rate by reducing use conditions such as temperature and voltage. Please be sure to have ample margin in your design.

【Expected Failure Rate】

- (a) Date based on our reliability tests: 8.2 Fit or less (Based on applied rated voltage at 105 °C)
- (b) Market failure rate: 0.13 Fit or less (Based on c=0, Reliability standard : 60 %)

1.7 Mounting area consideration

Isolate the surface of PCB under the mounted SP-Cap.

2. Mounting

2.1 When mounting

- (1) Check the SP-Cap ratings (capacitance and voltage) before mounting.
- (2) Check the SP-Cap polarity before mounting.
- (3) Check the land size for the SP-Cap before mounting.
- (4) When using a moulder, if the pressure for mounting is too high, then the current leak may increase, shortcircuiting may occur, or the SP-Cap may break down or come off.

2.2 Soldering

- (1) Reflow soldering

Be performed by one of following methods.

- (a) Ambient heat conduction reflow (IR / Hot-air)
Please refer to the page of "Mounting Specifications".
- (b) Vapor phase reflow (but only allowable for CX, CT, SX, ST, GX, LX, LT and HX series).
Please contact Panasonic for details of allowable vapor phase reflow condition.

- (2) Wave soldering and dip soldering

Please remind SP-Cap is NOT compatible.

- (3) Hand soldering

Excessive force stress to the SP-Cap should be avoided

Conditions

Tip temperature of soldering iron : 350 °C max.

Exposure time : 10 s max.

※ Once removed from the printed circuit board for any reason, please do not use the SP-Cap again.

2.3 Land size

Refer to the land size of "Mounting specifications" for appropriate design dimensions.

Circuit board design requires examination of the most suitable dimensions taking conditions such as circuit board, parts and reflow into consideration.

2.4 Mechanical stress

Do not apply excessive force to the SP-Cap this can damage the electrodes and badly affect the SP-Cap mount ability. It can also cause the increase of leakage current, separation of the lead wire and element, and damage to the SP-Cap body, all of which can badly affect the electrical performance of the SP-Cap.

2.5 Circuit board cleaning

SP-Cap should be cleaned after soldering in accordance with the following conditions.

Temperature : Less than 60 °C

Time : Within 5min

Be sure to sufficiently wash and dry (20 min at 100 °C) the board afterward.

【Recommended Cleaning Solvents】

Pine Alpha ST-100S, Clean-thru 750H / 750L / 710M, Aqua Cleaner 210SEP, Sunelec B-12

DK Beclear CW-5790, Techno Cleaner 219, Cold Cleaner P3-375, Telpene Cleaner EC-7R

Technocare FRW-17 / FRW-1 / FRV-1, AXREL 32, IPA (Isopropyl alcohol)

- (1) Consult our factory when performing processes with cleaning solvents other than those listed above or deionized water.
- (2) The use of ozone depleting cleaning agents are not recommended in the interest of protecting the environment.
- (3) In the case of using ultrasonic cleaning, the terminals may be broken. Therefore, please test before using in mass production.

3. Usage environment of equipment

Avoid using equipment to which SP-Cap are fitted in the following environments.

- (1) In liquid, such as Water, Oil, Chemicals, or Organic solvent.
- (2) In direct sunlight, outdoors, or in dust.
- (3) In vapor, such as dew condensation water of resistive element, or water leakage, salty air, or air with a high concentration corrosive gas, such as Cl₂, H₂S, NH₃, SO₂, or NO₂.
- (4) In an environment where strong static electricity or electromagnetic waves exist.
- (5) Mounting or placing heat-generating components or inflammables, such as vinyl-coated wires, near these SP-Cap.
- (6) Sealing or coating of these SP-Cap or a printed circuit board on which these SP-Cap are mounted, with resin and other material.
- (7) Acid or alkaline environments.
- (8) Environment subject to excessive vibration and shock.

4. Storage

SP-Cap should be stored in the moisture proof bag. Storage conditions before and after opening the moisture proof bag as follows.

(If these conditions are exceeded, the package may absorb moisture and there is a risk of damage to the exterior due to heat stress during mounting.)

[Environment of Storage]

Temperature	: 5 °C to 30 °C
Humidity	: Less than 70 %
Maximum storage term before opening the moisture proof bag	: 2 years after manufactured
Maximum storage condition after opening the moisture proof bag	: 7 days after opening

SP-Cap should be all used within the storage term after opening the moisture proof bag.

5. Transportation

Take sufficient care during handling because excessive vibration, or shock can cause the reliability of the SP-Cap to decrease.

6. Emergency procedures

If the SP-Cap is overheated, the resin case may emit smoke. If this occurs, immediately switch off the unit's main power supply to stop operation. Keep your face and hands away from the SP-Cap the temperature may be high enough to cause the SP-Cap to ignite and burn.

7. Discarding

Since SP-Cap are composed of various metals and resins, treat them as industrial waste when arranging for their disposal.

The precautions in using aluminum electrolytic capacitors follow the "Safety application guide for the use in fixed aluminum electrolytic capacitors for electronic equipment", RCR-2367D issued by JEITA in October 2017.
Please refer to the above application guide for details.

* Intellectual property right

We, Panasonic Group are providing the product and service that customers can use without anxiety, working positively on the protection of our products under intellectual property rights.

Representative patents relating to SP-Cap are as follows :

US Patent No. 7136276, No. 7787234

Line up

Series	P Art No.	Feature	Low profile	Low ESR	Low ESL	High voltage	High temp.	Category temperature (°C)	Rated voltage (V)	ESR (mΩ)	Capacitance (μF)	Size (mm)
												LxW 7.3x4.3 H
CX	EEFCX---	Standard				●		-55 to 105	2 to 35	12 to 40	15 to 560	1.9
CT	EEFCT---		●				●	-55 to 105	4 to 35	15 to 40	15 to 180	1.4
CS	EEFCS---		●				●	-55 to 105	4 to 35	15 to 40	10 to 120	1.1
SX	EEFSX---	Low ESR		●				-55 to 105	2 to 6.3	4.5 to 9	82 to 560	1.9
GX	EEFGX---	Super low ESR High ripple current		●	●			-55 to 105	2, 2.5	3	330 to 560	1.9
LX	EEFLX---	Low ESR · Low ESL		●	●			-55 to 105	2, 2.5	4.5 to 6	330 to 560	1.9
ST	EEFST---	Low profile · Low ESR	●	●				-55 to 105	2, 2.5	6	270 to 330	1.4
LT	EEFLT---	Low profile Low ESR · Low ESL	●	●	●			-55 to 105	2, 2.5	6	270 to 330	1.4
SS	EEFSS---	Low profile · Low ESR	●	●				-55 to 105	2, 2.5	6	180 to 220	1.1
LS	EEFLS---	Low profile Low ESR · Low ESL	●	●	●			-55 to 105	2, 2.5	6	180 to 220	1.1
SR	EEFSR---	Low profile (1.0 mm max.) Low ESR	●	●				-55 to 105	2 to 6.3	4.5 to 9	68 to 220	1.0 max.
LR	EEFLR---	Low profile (1.0 mm max.) Low ESR · Low ESL	●	●	●			-55 to 105	2 to 6.3	4.5 to 9	68 to 220	1.0 max.
GY	EEFGY---	Super low ESR High ripple current Height 3.0 mm max.		●				-55 to 105	2, 2.5	3	680 to 820	2.8
CY	ECGCY---	Guaranteed at 85 °C Height 3.0 mm max.		●				-55 to 85	4, 6.3	15	330 to 470	2.8
SY	ECGSY---			●				-55 to 85	4, 6.3	9	330 to 470	2.8
NEW JX	EEFJX---	Guaranteed at 125 °C		●			●	-55 to 125	2, 2.5	9	220 to 470	1.9
HX	EEFHX---	Guaranteed at 125 °C		●		●	●	-55 to 125	2 to 25	4.5 to 40	15 to 470	1.9

• 2 to 6.3 V : On sale

• 10 to 35 V : Not recommended for new design

※ Click [here](#) for Replacement (10 to 35 V)

Diagram

2-terminals

Standard

CX Series

Size(mm) : 7.3 x 4.3 x 1.9
 V/ μ F : 2/560 to 35/22
 ESR(m Ω) : 12 to 40

Low profile

CT Series

Size(mm) : 7.3 x 4.3 x 1.4
 V/ μ F : 4/180 to 35/15
 ESR(m Ω) : 15/40

CS Series

Size(mm) : 7.3 x 4.3 x 1.1
 V/ μ F : 4/120 to 35/10
 ESR(m Ω) : 15/40

Guaranteed at 85°C

CY/SY Series

Size(mm) : 7.3 x 4.3 x 2.8
 V/ μ F : 4/470 to 6.3/330
 ESR(m Ω) : 9/15

Guaranteed at 125°C

NEW

JX Series

Size(mm) : 7.3 x 4.3 x 1.9
 V/ μ F : 2/470 to 2.5/390
 ESR(m Ω) : 9

HX Series

Size(mm) : 7.3 x 4.3 x 1.9
 V/ μ F : 2/470 to 25/33
 ESR(m Ω) : 4.5 to 40

Low ESR

GY Series

Size(mm) : 7.3 x 4.3 x 2.8
 V/ μ F : 2/820 to 2.5/680
 ESR(m Ω) : 3

GX Series

Size(mm) : 7.3 x 4.3 x 1.9
 V/ μ F : 2/560 to 2.5/470
 ESR(m Ω) : 3

Super low ESR

SX Series

Size(mm) : 7.3 x 4.3 x 1.9
 V/ μ F : 2/560 to 6.3/220
 ESR(m Ω) : 4.5 to 9

Low profile

ST Series

Size(mm) : 7.3 x 4.3 x 1.4
 V/ μ F : 2/330 to 2.5/270
 ESR(m Ω) : 6

SS Series

Size(mm) : 7.3 x 4.3 x 1.1
 V/ μ F : 2/220 to 2.5/180
 ESR(m Ω) : 6

SR Series

Size(mm) : 7.3 x 4.3 x 1.0(max.)
 V/ μ F : 2/220 to 6.3/68
 ESR(m Ω) : 4.5 to 9

3-terminals

Low ESR/Low ESL*

GX-L Series

Size(mm) : 7.3 x 4.3 x 1.9
 V/ μ F : 2/560 to 2.5/470
 ESR(m Ω) : 3

Super low ESR

LX Series

Size(mm) : 7.3 x 4.3 x 1.9
 V/ μ F : 2/560 to 2.5/470
 ESR(m Ω) : 4.5/6

Low profile

LT Series

Size(mm) : 7.3 x 4.3 x 1.4
 V/ μ F : 2/330 to 2.5/270
 ESR(m Ω) : 6

LS Series

Size(mm) : 7.3 x 4.3 x 1.1
 V/ μ F : 2/220 to 2.5/180
 ESR(m Ω) : 6

LR Series

Size(mm) : 7.3 x 4.3 x 1.0(max.)
 V/ μ F : 2/220 to 6.3/68
 ESR(m Ω) : 4.5 to 9

*ESL : 0.5nH (Typ.)

Explanation of part numbers

◇ Part number system

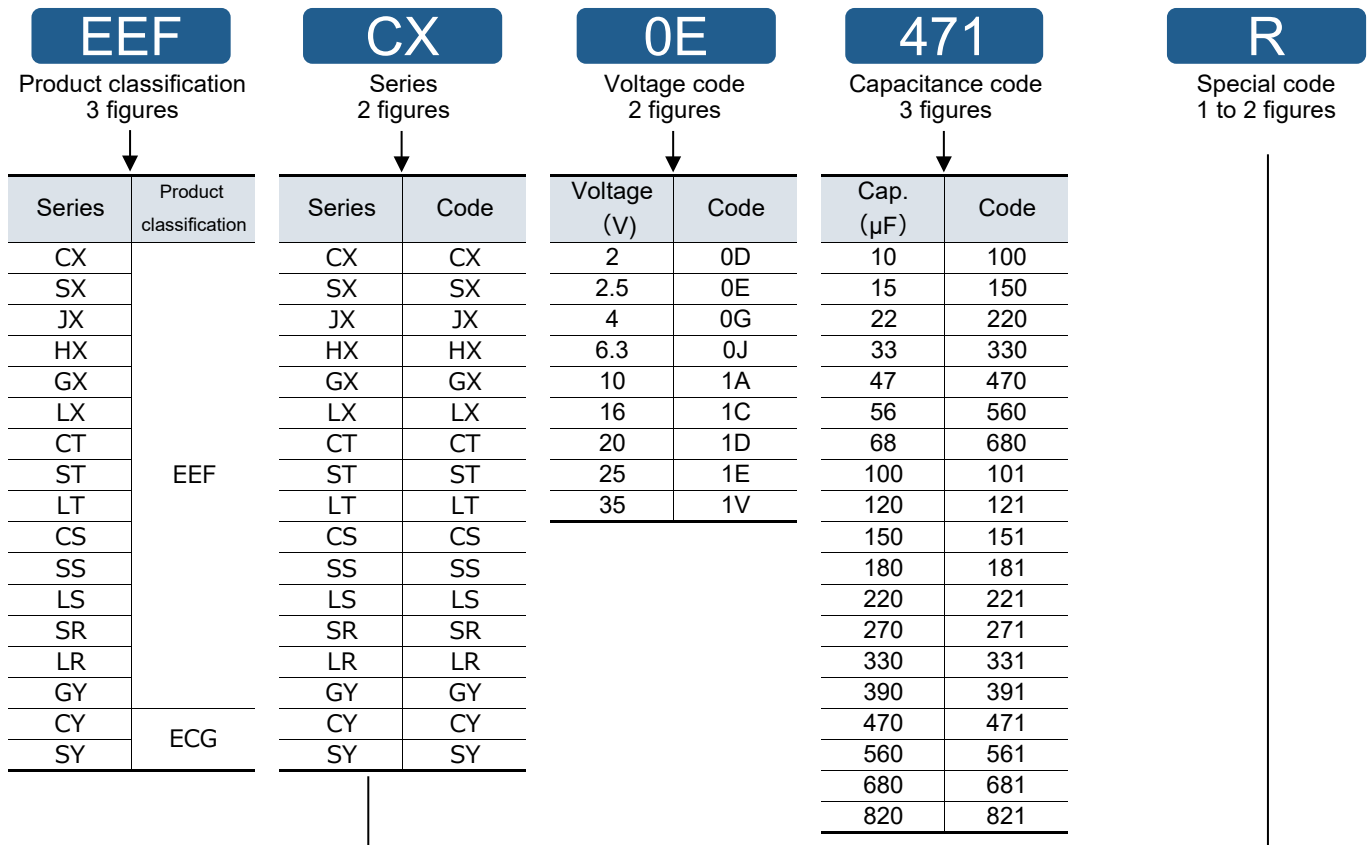

Height (mm)	Series	Special code	ESR (mΩ max.)	Terminals	
				2	3
1.9 ± 0.1	CX	R	15 (to 6.3 V), 40 (10 V to 35 V)	○	
		XR	12	○	
	SX	ER	9	○	
		E7	7	○	
		XE	6	○	
	JX	E4	4.5	○	
		RE	9	○	
	HX	R	15 (to 2.5 V), 40 (10 V to 25 V)	○	
		R9	9	○	
		R6	6	○	
		R4	4.5	○	
	GX	R	3	○	
L		3		○	
LX	R	6		○	
	R4	4.5		○	
1.4 ± 0.1	CT	R	15 (to 6.3 V), 40 (10 V to 35 V)	○	
	ST	R	6	○	
	LT	R	6		○
1.1 ± 0.1	CS	R	15 (to 6.3 V), 40 (10 V to 35 V)	○	
	SS	R	6	○	
	LS	R	6		○
1.0 (max.)	SR	R	6 (to 2.5 V), 9 (4 V to 6.3 V)	○	
		R4	4.5	○	
	LR	R	6 (to 2.5 V), 9 (4 V to 6.3 V)		○
		R4	4.5		○
2.8 ± 0.2	GY	R	3	○	
	CY	R	15	○	
	SY	R	9	○	

Mounting specification

● Recommendable reflow soldering

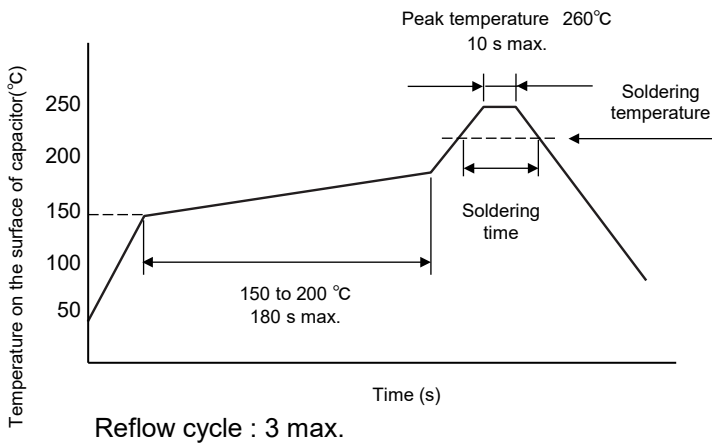

Soldering temperature and soldering time

Temperature	Time
≧ 255°C	30 s max.
≧ 230°C	130 s max.
≧ 217°C	150 s max.

SP-Cap recommended profile condition of the IPC/J-STD-020D standard

● Typical land pattern

□ 2-terminals

For standard terminal (C*, S*, G*, JX, HX series)

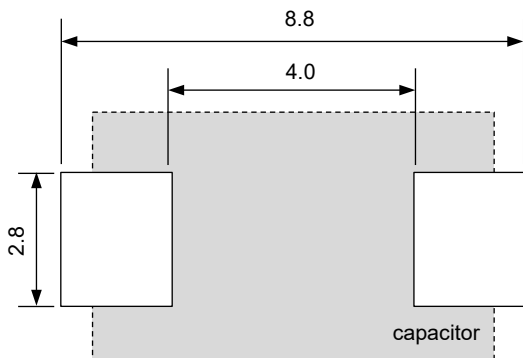

□ 3-terminals

For low ESL terminal (L*, GX-L series)

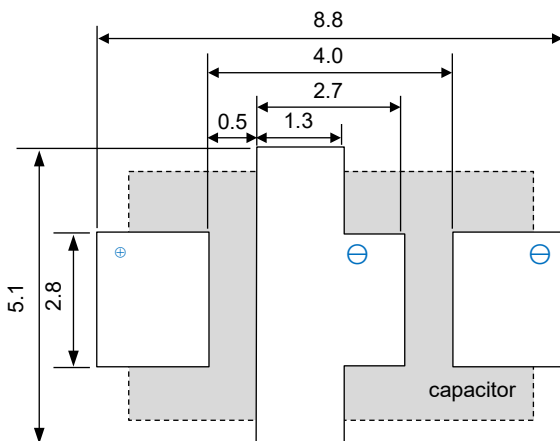

〈VIA〉

For low ESL terminal (L*, GX-L series)

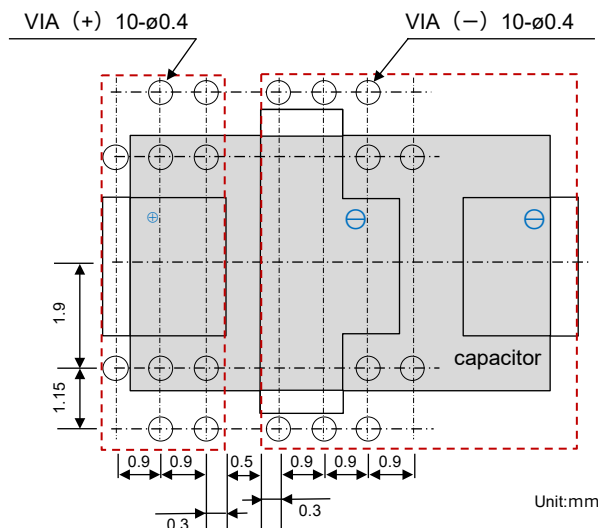

Packaging specifications

● Reel dimensions

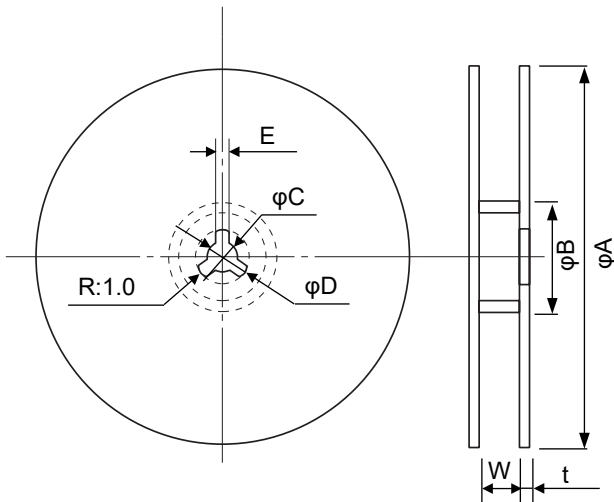

Unit:mm							
Reel	φA	φB	φC	φD	E	W	t
φ330	330	80	13±0.5	21±0.8	2±0.5	14	3
φ180	180	60	13±0.5	21±0.8	2±0.5	14	3

● Embossed taping

(12mm tape)

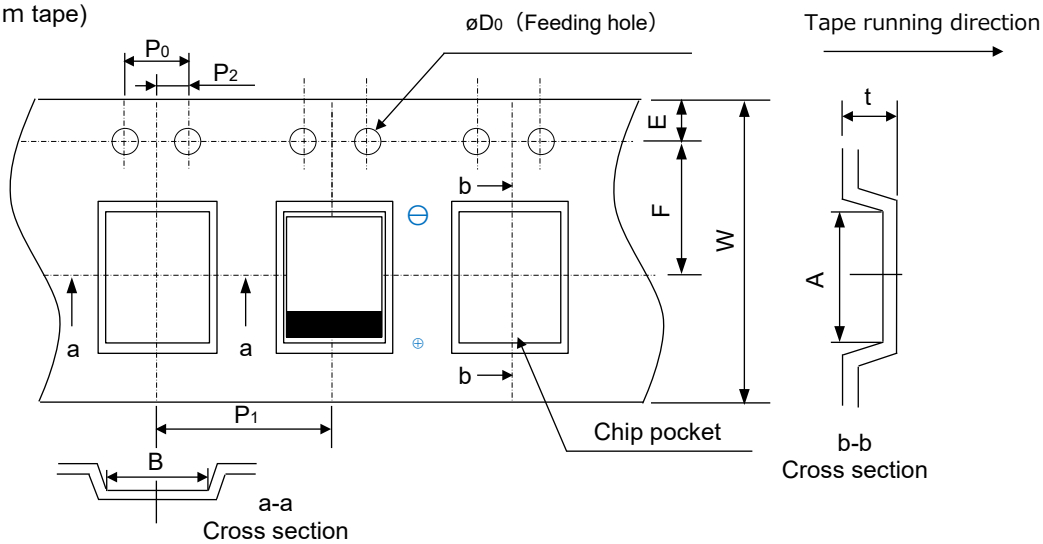

Unit:mm					
A	B	W	F	E	P1
7.6±0.2	4.5±0.2	12±0.3	5.5±0.1	1.75±0.1	8.0±0.1
P2	P0	φD0	Upper row : Product height / Lower berth : t		
			to 1.1	1.4 to 1.9	2.8
2.0±0.1	4.0±0.1	1.5 ^{+0.1} ₀	1.5±0.2	2.4±0.2	3.5±0.2

● Packaging box dimensions

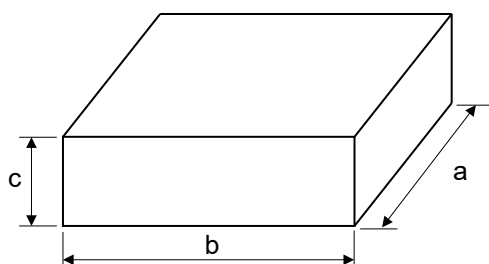

Unit:mm			
Reel	a	b	c
φ330	400 max.	400 max.	135 max.
φ180	320 max.	240 max.	135 max.

**Conductive Polymer Aluminum
Electrolytic Capacitors**
Surface Mount Type
CS/CT/CX series

SP-Cap



Features

- High voltage (35 V max.)
- Low profile (Height 1.0 mm max.)
- High ripple current (5600 mA rms max.)
- RoHS compliance, Halogen free

• 2 to 6.3 V : On sale
 • 10 to 35 V : Not recommended for new design
 ※ Click [here](#) for Replacement (10 to 35 V)

Specifications

Series	CS	CT	CX	
Category temp. range	-55 °C to +105 °C			
Rated voltage range	4.0 V to 35 V		2.0 V to 35 V	
Rated cap. range	10 µF to 120 µF	15 µF to 180 µF	15 µF to 560 µF	
Capacitance tolerance	±20 % (120 Hz / +20 °C)			
DC leakage current	$I \leq 0.1 CV(\mu A)$ [2.0 V to 6.3 V, 2 min], $I \leq 0.3 CV(\mu A)$ [10 V to 35 V, 2 min]			
Dissipation factor (tan δ)	≤ 0.06 (120 Hz / + 20 °C)			
Surge voltage (V)	Rated voltage × 1.25 [2.0 V to 16 V], × 1.15 [20 V to 35 V] (15 °C to 35 °C)			
Endurance	+105 °C 2000 h, rated voltage applied			
	Capacitance change	Within ±20 % of the initial value		
	Dissipation factor (tan δ)	≤ 2 times of the initial limit		
	DC leakage current	≤ 3 times of the initial limit : 2.0 V to 6.3 V Within the initial limit : 10 V to 35 V		
Damp heat (Steady state)	+60 °C, 90 % RH, 500 h, No-applied voltage			
	Capacitance change of initial measurd value	2.0 V to 2.5 V +70 %, -20 %	4.0 V, 10 V to 35 V +60 %, -20 %	6.3 V +50 %, -20 %
	Dissipation factor (tan δ)	≤ 2 times of the initial limit		
	DC leakage current	Within the initial limit : 2.0 V to 6.3 V ≤ 3 times of the initial limit : 10 V to 35 V		

Marking

R. voltage code		Unit : V			
d	2.0	j	6.3	D	20
e	2.5	A	10	E	25
g	4.0	C	16	V	35

Dimensions (not to scale)

Unit : mm					
Series	L±0.2	W1±0.2	W2±0.1	H±0.1	P±0.3
CS	7.3	4.3	2.4	1.1	1.3
CT	7.3	4.3	2.4	1.4	1.3
CX	7.3	4.3	2.4	1.9	1.3

* Externals of figure are the reference.

Characteristics list

■ 2.0 V to 6.3 V

Series	Rated voltage (V)	Capacitance (μF)	Case size (mm)			Specification		Part number	Min. Packaging Q'ty ^{*3} (pcs)
			L	W	H	Ripple current ^{*1} (mA rms)	ESR ^{*2} (mΩ max.)		
CS	4.0	120	7.3	4.3	1.1	5100	15	EEFCS0G121R	3500
	6.3	68	7.3	4.3	1.1	5100	15	EEFCS0J680R	3500
CT	4.0	180	7.3	4.3	1.4	5100	15	EEFCT0G181R	3500
	6.3	100	7.3	4.3	1.4	5100	15	EEFCT0J101R	3500
CX	2.0	220	7.3	4.3	1.9	5100	15	EEFCX0D221R	3500
		270	7.3	4.3	1.9	5600	12	EEFCX0D271XR	3500
		330	7.3	4.3	1.9	5100	15	EEFCX0D331R	3500
			7.3	4.3	1.9	5600	12	EEFCX0D331XR	3500
		390	7.3	4.3	1.9	5100	15	EEFCX0D391R	3500
		470	7.3	4.3	1.9	5100	15	EEFCX0D471R	3500
		560	7.3	4.3	1.9	5100	15	EEFCX0D561R	3500
	2.5	220	7.3	4.3	1.9	5100	15	EEFCX0E221R	3500
		330	7.3	4.3	1.9	5100	15	EEFCX0E331R	3500
		390	7.3	4.3	1.9	5100	15	EEFCX0E391R	3500
		470	7.3	4.3	1.9	5100	15	EEFCX0E471R	3500
	4.0	150	7.3	4.3	1.9	5100	15	EEFCX0G151R	3500
		180	7.3	4.3	1.9	5100	15	EEFCX0G181R	3500
			7.3	4.3	1.9	5600	12	EEFCX0G181XR	3500
		220	7.3	4.3	1.9	5100	15	EEFCX0G221R	3500
			7.3	4.3	1.9	5600	12	EEFCX0G221XR	3500
		270	7.3	4.3	1.9	5100	15	EEFCX0G271R	3500
		330	7.3	4.3	1.9	5100	15	EEFCX0G331R	3500
	6.3	100	7.3	4.3	1.9	5100	15	EEFCX0J101R	3500
		120	7.3	4.3	1.9	5100	15	EEFCX0J121R	3500
		150	7.3	4.3	1.9	5100	15	EEFCX0J151R	3500
			7.3	4.3	1.9	5600	12	EEFCX0J151XR	3500
		180	7.3	4.3	1.9	5100	15	EEFCX0J181R	3500
		220	7.3	4.3	1.9	5100	15	EEFCX0J221R	3500

*1: Ripple current (100 kHz / +45 °C)

*2: ESR (100 kHz / +20 °C)

*3: Please contact us when 500 pcs packing is necessary.

◆ Please refer to each page in this catalog for "Reflow conditions" and "Taping specifications".

Temperature coefficient of ripple current

Temperature		$T \leq 45 \text{ }^{\circ}\text{C}$	$45 \text{ }^{\circ}\text{C} < T \leq 85 \text{ }^{\circ}\text{C}$	$85 \text{ }^{\circ}\text{C} < T \leq 105 \text{ }^{\circ}\text{C}$
2.0 V to 6.3 V	Coefficient	1.0	0.7	0.25

◆ Ripple current should be controlled so that surface temperature of capacitor does not exceed the category temperature.

Characteristics list

■ 10 V to 35 V

Not Recommended for New Design

For replacement

Series	Rated voltage (V)	Capacitance (μF)	Case size (mm)			Specification		Part number	Min. Packaging Q'ty ^{*3} (pcs)
			L	W	H	Ripple current ^{*1} (mA rms)	ESR ^{*2} (mΩ max.)		
CS	10	47	7.3	4.3	1.1	3200	40	EEFCS1A470R	3500
	16	15	7.3	4.3	1.1	3200	40	EEFCS1C150R	3500
		22	7.3	4.3	1.1	3200	40	EEFCS1C220R	3500
		33	7.3	4.3	1.1	3200	40	EEFCS1C330R	3500
	20	10	7.3	4.3	1.1	3200	40	EEFCS1D100R	3500
		15	7.3	4.3	1.1	3200	40	EEFCS1D150R	3500
		22	7.3	4.3	1.1	3200	40	EEFCS1D220R	3500
	25	10	7.3	4.3	1.1	3200	40	EEFCS1E100R	3500
		15	7.3	4.3	1.1	3200	40	EEFCS1E150R	3500
	35	10	7.3	4.3	1.1	3200	40	EEFCS1V100R	3500
CT	10	68	7.3	4.3	1.4	3200	40	EEFCT1A680R	3500
	16	47	7.3	4.3	1.4	3200	40	EEFCT1C470R	3500
		33	7.3	4.3	1.4	3200	40	EEFCT1D330R	3500
	20	47	7.3	4.3	1.4	3200	40	EEFCT1D470R	3500
		22	7.3	4.3	1.4	3200	40	EEFCT1E220R	3500
	35	15	7.3	4.3	1.4	3200	40	EEFCT1V150R	3500
CX	10	47	7.3	4.3	1.9	3200	40	EEFCX1A470R	3500
		68	7.3	4.3	1.9	3200	40	EEFCX1A680R	3500
		100	7.3	4.3	1.9	3200	40	EEFCX1A101R	3500
	16	15	7.3	4.3	1.9	3200	40	EEFCX1C150R	3500
		22	7.3	4.3	1.9	3200	40	EEFCX1C220R	3500
		33	7.3	4.3	1.9	3200	40	EEFCX1C330R	3500
		47	7.3	4.3	1.9	3200	40	EEFCX1C470R	3500
		68	7.3	4.3	1.9	3200	40	EEFCX1C680R	3500
		22	7.3	4.3	1.9	3200	40	EEFCX1D220R	3500
	20	33	7.3	4.3	1.9	3200	40	EEFCX1D330R	3500
		47	7.3	4.3	1.9	3200	40	EEFCX1D470R	3500
		56	7.3	4.3	1.9	3200	40	EEFCX1D560R	3500
		15	7.3	4.3	1.9	3200	40	EEFCX1E150R	3500
	25	22	7.3	4.3	1.9	3200	40	EEFCX1E220R	3500
		33	7.3	4.3	1.9	3200	40	EEFCX1E330R	3500
		15	7.3	4.3	1.9	3200	40	EEFCX1V150R	3500
	35	22	7.3	4.3	1.9	3200	40	EEFCX1V220R	3500

*1: Ripple current (100 kHz / +45 °C)

*2: ESR (100 kHz / +20 °C)

*3: Please contact us when 500 pcs packing is necessary.

◆ Please refer to each page in this catalog for "Reflow conditions" and "Taping specifications".

Temperature coefficient of ripple current

Temperature		T ≤ 45 °C	45 °C < T ≤ 85 °C	85 °C < T ≤ 105 °C
10 V to 35 V	Coefficient	1.0	0.8	0.5

◆ Ripple current should be controlled so that surface temperature of capacitor does not exceed the category temperature.

**Conductive Polymer Aluminum
Electrolytic Capacitors**
Surface Mount Type

SX series [Low ESR products]

SP-Cap

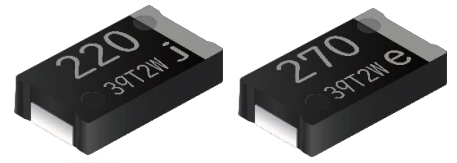

Features

- Large capacitance (560 μ F max.)
- Low ESR (4.5 m Ω to 9 m Ω max.)
- High ripple current (8500 mA rms max.)
- RoHS compliance, Halogen free

Specifications

Series	SX			
Category temp. range	-55 °C to +105 °C			
Rated voltage range	2.0 V to 6.3 V			
Rated cap. range	82 μ F to 560 μ F			
Capacitance tolerance	\pm 20 % (120 Hz / +20 °C)			
DC leakage current	$I \leq 0.1 CV$ (μ A) 2 minutes			
Dissipation factor (tan δ)	≤ 0.06 (120 Hz / + 20 °C)			
Surge voltage (V)	Rated voltage \times 1.25 (15 °C to 35 °C)			
Endurance	+105 °C 2000 h, rated voltage applied			
	Capacitance change	Within \pm 20 % of the initial value		
	Dissipation factor (tan δ)	≤ 2 times of the initial limit		
	DC leakage current	≤ 3 times of the initial limit		
Damp heat (Steady state)	+60 °C, 90 % RH, 500 h, No-applied voltage			
	Capacitance change of initial measured value	2.0 V to 2.5 V	4.0 V	6.3 V
		+70 %, -20 %	+60 %, -20 %	+50 %, -20 %
	Dissipation factor (tan δ)	≤ 2 times of the initial limit		
DC leakage current	Within the initial limit			

Marking

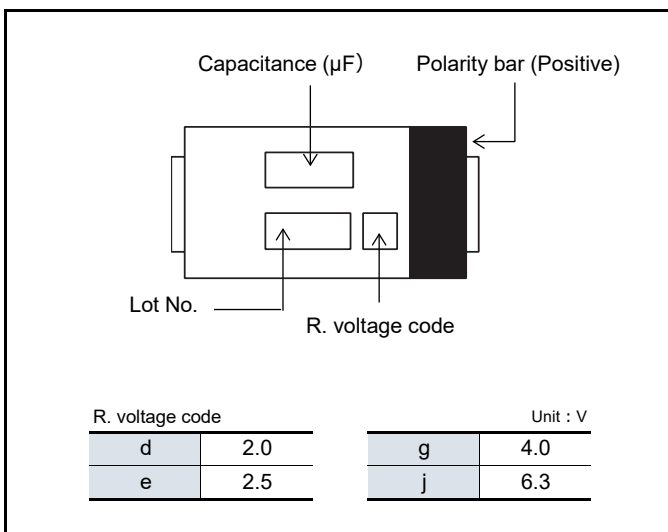

Dimensions (not to scale)

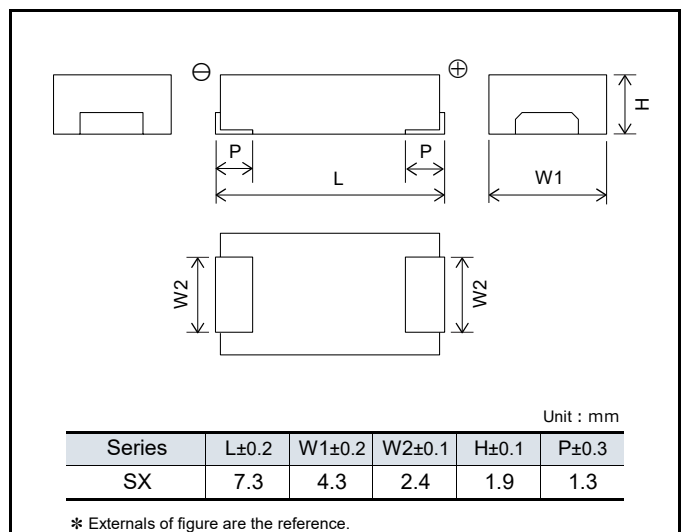

Characteristics list

Series	Rated voltage (V)	Capacitance (μF)	Case size (mm)			Specification		Part number	Min. Packaging Q'ty ^{*3} (pcs)		
			L	W	H	Ripple current ^{*1} (mA rms)	ESR ^{*2} (mΩ max.)				
SX	2.0	180	7.3	4.3	1.9	6300	9	EEFSX0D181ER	3500		
		220	7.3	4.3	1.9	6300	9	EEFSX0D221ER	3500		
		270	7.3	4.3	1.9	6300	9	EEFSX0D271ER	3500		
			7.3	4.3	1.9	7500	6	EEFSX0D271XE	3500		
		330	7.3	4.3	1.9	8500	4.5	EEFSX0D271E4	3500		
			7.3	4.3	1.9	6300	9	EEFSX0D331ER	3500		
			7.3	4.3	1.9	7500	6	EEFSX0D331XE	3500		
		390	7.3	4.3	1.9	8500	4.5	EEFSX0D331E4	3500		
			7.3	4.3	1.9	6300	9	EEFSX0D391ER	3500		
			7.3	4.3	1.9	7500	6	EEFSX0D391XE	3500		
		470	7.3	4.3	1.9	8500	4.5	EEFSX0D391E4	3500		
			7.3	4.3	1.9	6300	9	EEFSX0D471ER	3500		
			7.3	4.3	1.9	7500	6	EEFSX0D471XE	3500		
				7.3	4.3	1.9	8500	4.5	EEFSX0D471E4	3500	
				560	7.3	4.3	1.9	8500	4.5	EEFSX0D561E4	3500
		2.5	150	7.3	4.3	1.9	6300	9	EEFSX0E151ER	3500	
			180	7.3	4.3	1.9	6300	9	EEFSX0E181ER	3500	
			220	7.3	4.3	1.9	6300	9	EEFSX0E221ER	3500	
	7.3			4.3	1.9	7000	7	EEFSX0E221E7	3500		
	270		7.3	4.3	1.9	7000	7	EEFSX0E271E7	3500		
			7.3	4.3	1.9	6300	9	EEFSX0E331ER	3500		
			7.3	4.3	1.9	7500	6	EEFSX0E331XE	3500		
	330		7.3	4.3	1.9	8500	4.5	EEFSX0E331E4	3500		
			7.3	4.3	1.9	6300	9	EEFSX0E391ER	3500		
			7.3	4.3	1.9	7500	6	EEFSX0E391XE	3500		
	390		7.3	4.3	1.9	8500	4.5	EEFSX0E391E4	3500		
			7.3	4.3	1.9	6300	9	EEFSX0E471ER	3500		
			7.3	4.3	1.9	7500	6	EEFSX0E471XE	3500		
	470		7.3	4.3	1.9	8500	4.5	EEFSX0E471E4	3500		
			82	7.3	4.3	1.9	6300	9	EEFSX0G820ER	3500	
			100	7.3	4.3	1.9	6300	9	EEFSX0G101ER	3500	
	4.0		150	7.3	4.3	1.9	6300	9	EEFSX0G151ER	3500	
				7.3	4.3	1.9	7000	7	EEFSX0G151E7	3500	
		180	7.3	4.3	1.9	6300	9	EEFSX0G181ER	3500		
		220	7.3	4.3	1.9	6300	9	EEFSX0G221ER	3500		
		270	7.3	4.3	1.9	6300	9	EEFSX0G271ER	3500		
			7.3	4.3	1.9	6300	9	EEFSX0G331ER	3500		
	330	7.3	4.3	1.9	7500	6	EEFSX0G331XE	3500			
		120	7.3	4.3	1.9	7000	7	EEFSX0J121E7	3500		
	6.3	150	7.3	4.3	1.9	6300	9	EEFSX0J151ER	3500		
		180	7.3	4.3	1.9	6300	9	EEFSX0J181ER	3500		
		220	7.3	4.3	1.9	6300	9	EEFSX0J221ER	3500		
7.3			4.3	1.9	6300	9	EEFSX0J221ER	3500			

*1: Ripple current (100 kHz / +45 °C)

*2: ESR (100 kHz / +20 °C)

*3: Please contact us when 500 pcs packing is necessary.

◆ Please refer to each page in this catalog for "Reflow conditions" and "Taping specifications".

Temperature coefficient of ripple current

Temperature		T ≤ 45 °C	45 °C < T ≤ 85 °C	85 °C < T ≤ 105 °C
2.0 V to 6.3 V	Coefficient	1.0	0.7	0.25

◆ Ripple current should be controlled so that surface temperature of capacitor does not exceed the category temperature.

Conductive Polymer Aluminum

Electrolytic Capacitors

Surface Mount Type

GX/GX-L series [Super low ESR products]

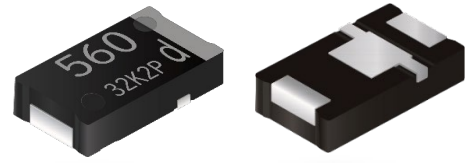

Features

- Large capacitance (560 μF max.)
- Super Low ESR (3 mΩ max.)
- Low ESL (3-terminals : 50 % less than 2-terminals) [Suffix : L]
- High ripple current (10200 mA rms max.)
- RoHS compliance, Halogen free

Specifications

Series	GX	
Category temp. range	-55 °C to +105 °C	
Rated voltage range	2.0 V to 2.5 V	
Rated cap. range	330 μF to 560 μF	
Capacitance tolerance	±20 % (120 Hz / +20 °C)	
DC leakage current	I ≤ 0.1 CV (μA) 2 minutes	
Dissipation factor (tan δ)	≤ 0.06 (120 Hz / + 20 °C)	
Surge voltage (V)	Rated voltage × 1.25 (15 °C to 35 °C)	
Endurance	+105 °C 2000 h, rated voltage applied	
	Capacitance change	Within ±20 % of the initial value
	Dissipation factor (tan δ)	≤ 2 times of the initial limit
	DC leakage current	≤ 3 times of the initial limit
Damp heat (Steady state)	+60 °C, 90 % RH, 500 h, No-applied voltage	
	Capacitance change of initial measurd value	2.0 V to 2.5 V +70 %, -20 %
	Dissipation factor (tan δ)	≤ 2 times of the initial limit
	DC leakage current	Within the initial limit

Marking

R. voltage code	Unit : V
d	2.0
e	2.5

Dimensions (not to scale)

Unit : mm					
Series	L±0.2	W1±0.2	W2±0.1	H±0.1	P±0.3
GX	7.3	4.3	2.4	1.9	1.3

Unit : mm								
Series	L±0.2	W1±0.2	W2±0.1	H±0.1	P1±0.3	P2±0.1	P3±0.2	P4±0.2
GX-L	7.3	4.3	2.4	1.9	1.3	1.1	0.7	1.4

* Externals of figure are the reference.

Characteristics list

Series	Rated voltage (V)	Capacitance (μF)	Case size (mm)			Specification		The number of terminals		Part number	Min. Packaging Q'ty ^{*3} (pcs)
			L	W	H	Ripple current ^{*1} (mA rms)	ESR ^{*2} (mΩ max.)	2	3		
GX	2.0	330	7.3	4.3	1.9	10200	3	○		EEFGX0D331R	3500
		470	7.3	4.3	1.9	10200	3	○		EEFGX0D471R	3500
			7.3	4.3	1.9	10200	3		○	EEFGX0D471L	3500
		560	7.3	4.3	1.9	10200	3	○		EEFGX0D561R	3500
			7.3	4.3	1.9	10200	3		○	EEFGX0D561L	3500
	2.5	330	7.3	4.3	1.9	10200	3	○		EEFGX0E331R	3500
		470	7.3	4.3	1.9	10200	3	○		EEFGX0E471R	3500
			7.3	4.3	1.9	10200	3		○	EEFGX0E471L	3500
			7.3	4.3	1.9	10200	3		○	EEFGX0E471L	3500

*1: Ripple current (100 kHz / +45 °C)

*2: ESR (100 kHz / +20 °C)

*3: Please contact us when 500 pcs packing is necessary.

◆ Please refer to each page in this catalog for "Reflow conditions" and "Taping specifications".

Temperature coefficient of ripple current

Temperature		T ≤ 45 °C	45 °C < T ≤ 85 °C	85 °C < T ≤ 105 °C
2.0 V to 2.5 V	Coefficient	1.0	0.7	0.25

◆ Ripple current should be controlled so that surface temperature of capacitor does not exceed the category temperature.

**Conductive Polymer Aluminum
Electrolytic Capacitors**
Surface Mount Type

LX series [Low ESR / Low ESL products]

SP-Cap

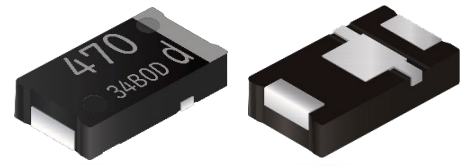

Features

- Large capacitance (560 μF max.)
- Low ESR (4.5 mΩ, 6 mΩ max.)
- Low ESL (3-terminals : 50 % less than 2-terminals)
- High ripple current (8500 mA rms max.)
- RoHS compliance, Halogen free

Specifications

Series	LX	
Category temp. range	-55 °C to +105 °C	
Rated voltage range	2.0 V to 2.5 V	
Rated cap. range	330 μF to 560 μF	
Capacitance tolerance	±20 % (120 Hz / +20 °C)	
DC leakage current	I ≤ 0.1 CV (μA) 2 minutes	
Dissipation factor (tan δ)	≤ 0.06 (120 Hz / + 20 °C)	
Surge voltage (V)	Rated voltage × 1.25 (15 °C to 35 °C)	
Endurance	+105 °C 2000 h, rated voltage applied	
	Capacitance change	Within ±20 % of the initial value
	Dissipation factor (tan δ)	≤ 2 times of the initial limit
	DC leakage current	≤ 3 times of the initial limit
Damp heat (Steady state)	+60 °C, 90 % RH, 500 h, No-applied voltage	
	Capacitance change of initial measurd value	2.0 V to 2.5 V +70 %, -20 %
	Dissipation factor (tan δ)	≤ 2 times of the initial limit
	DC leakage current	Within the initial limit

Marking

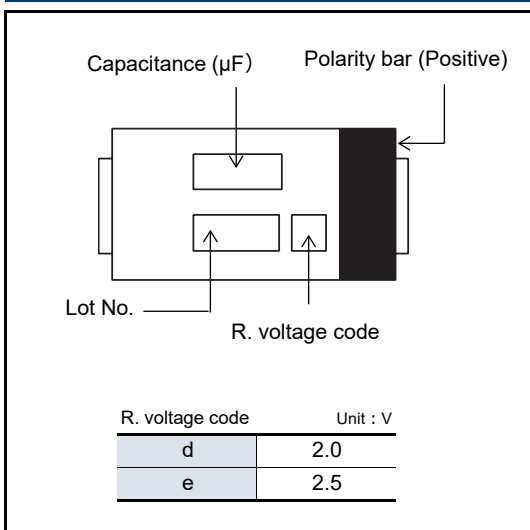

Dimensions (not to scale)

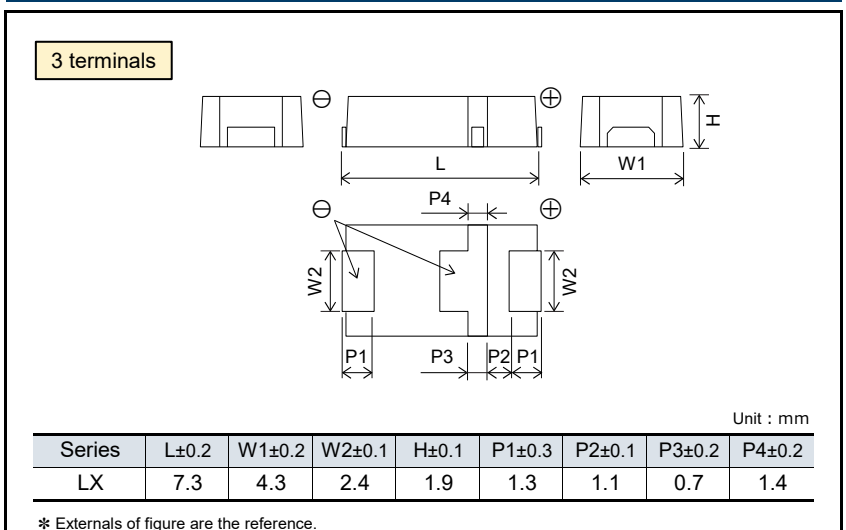

Characteristics list

Series	Rated voltage (V)	Capacitance (μF)	Case size (mm)			Specification		Part number	Min. Packaging Q'ty ^{*3} (pcs)
			L	W	H	Ripple current ^{*1} (mA rms)	ESR ^{*2} (m Ω max.)		
LX	2.0	330	7.3	4.3	1.9	7500	6	EEFLX0D331R	3500
			7.3	4.3	1.9	8500	4.5	EEFLX0D331R4	3500
		470	7.3	4.3	1.9	7500	6	EEFLX0D471R	3500
			7.3	4.3	1.9	8500	4.5	EEFLX0D471R4	3500
		560	7.3	4.3	1.9	7500	6	EEFLX0D561R	3500
			7.3	4.3	1.9	8500	4.5	EEFLX0D561R4	3500
	2.5	330	7.3	4.3	1.9	7500	6	EEFLX0E331R	3500
			7.3	4.3	1.9	8500	4.5	EEFLX0E331R4	3500
		470	7.3	4.3	1.9	7500	6	EEFLX0E471R	3500
			7.3	4.3	1.9	8500	4.5	EEFLX0E471R4	3500

*1: Ripple current (100 kHz / +45 °C)

*2: ESR (100 kHz / +20 °C)

*3: Please contact us when 500 pcs packing is necessary.

◆ Please refer to each page in this catalog for "Reflow conditions" and "Taping specifications".

Temperature coefficient of ripple current

Temperature		$T \leq 45\text{ °C}$	$45\text{ °C} < T \leq 85\text{ °C}$	$85\text{ °C} < T \leq 105\text{ °C}$
2.0 V to 2.5 V	Coefficient	1.0	0.7	0.25

◆ Ripple current should be controlled so that surface temperature of capacitor does not exceed the category temperature.

Conductive Polymer Aluminum Electrolytic Capacitors

Surface Mount Type

SR/LR/SS/LS/ST/LT series

SP-Cap

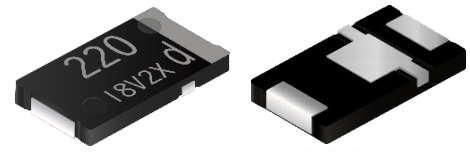

Features

- Low profile (Height 1.0 mm max.)
- Low ESR (4.5 mΩ to 9 mΩ max.)
- Low ESL (3-terminals : 50% less than 2-terminals) [LR/LS/LT series]
- High ripple current (8500 mA rms max.)
- RoHS compliance, Halogen free

Specifications

Series	SR	LR	SS	LS	ST	LT	
Category temp. range	-55 °C to +105 °C						
Rated voltage range	2.0 V to 6.3 V		2.0 V to 2.5 V				
Rated cap. range	68 μF to 220 μF		180 μF to 220 μF		270 μF to 330 μF		
Capacitance tolerance	±20 % (120 Hz / +20 °C)						
DC leakage current	I ≤ 0.1 CV (μA) 2 minutes						
Dissipation factor (tan δ)	≤ 0.06 (120 Hz / +20 °C)						
Surge voltage (V)	Rated voltage × 1.25 (15 °C to 35 °C)						
Endurance	+105 °C 2000 h, rated voltage applied						
	Capacitance change		Within ±20 % of the initial value				
	Dissipation factor (tan δ)		≤ 2 times of the initial limit				
	DC leakage current		≤ 3 times of the initial limit				
Damp heat (Steady state)	+60 °C, 90 % RH, 500 h, No-applied voltage						
	Capacitance change of initial measured value		2.0 V to 2.5 V	4.0 V		6.3 V	
			+70 %, -20 %	+60 %, -20 %		+50 %, -20 %	
	Dissipation factor (tan δ)		≤ 2 times of the initial limit				
DC leakage current		Within the initial limit					

Marking

R. voltage code	Unit : V
d	2.0
e	2.5
g	4.0
j	6.3

Dimensions (not to scale)

SR/SS/ST series

Series	L±0.2	W1±0.2	W2±0.1	H±0.1	P±0.3
SR	7.3	4.3	2.4	1.0 ^{*1}	1.3
SS	7.3	4.3	2.4	1.1	1.3
ST	7.3	4.3	2.4	1.4	1.3

*1: max.

LR/LS/LT series

Series	L±0.2	W1±0.2	W2±0.1	H±0.1	P1±0.3	P2±0.1	P3±0.2	P4±0.2
LR	7.3	4.3	2.4	1.0 ^{*1}	1.3	1.1	0.7	1.4
LS	7.3	4.3	2.4	1.1	1.3	1.1	0.7	1.4
LT	7.3	4.3	2.4	1.4	1.3	1.1	0.7	1.4

*1: max.

* Externals of figure are the reference.

Characteristics list

Series	Rated voltage (V)	Capacitance (μF)	Case size (mm)			Specification		The number of terminals		Part number	Min. Packaging Q'ty ^{*3} (pcs)
			L	W	H	Ripple current ^{*1} (mA rms)	ESR ^{*2} (mΩ max.)	2	3		
SR	2.0	220	7.3	4.3	1.0 max.	7500	6	○		EEFSR0D221R	3500
			7.3	4.3	1.0 max.	8500	4.5	○		EEFSR0D221R4	3500
	2.5	180	7.3	4.3	1.0 max.	7500	6	○		EEFSR0E181R	3500
			7.3	4.3	1.0 max.	8500	4.5	○		EEFSR0E181R4	3500
	4.0	120	7.3	4.3	1.0 max.	6300	9	○		EEFSR0G121R	3500
	6.3	68	7.3	4.3	1.0 max.	6300	9	○		EEFSR0J680R	3500
LR	2.0	220	7.3	4.3	1.0 max.	7500	6		○	EEFLR0D221R	3500
			7.3	4.3	1.0 max.	8500	4.5		○	EEFLR0D221R4	3500
	2.5	180	7.3	4.3	1.0 max.	7500	6		○	EEFLR0E181R	3500
			7.3	4.3	1.0 max.	8500	4.5		○	EEFLR0E181R4	3500
	4.0	120	7.3	4.3	1.0 max.	6300	9		○	EEFLR0G121R	3500
	6.3	68	7.3	4.3	1.0 max.	6300	9		○	EEFLR0J680R	3500
SS	2.0	220	7.3	4.3	1.1	7500	6	○		EEFSS0D221R	3500
	2.5	180	7.3	4.3	1.1	7500	6	○		EEFSS0E181R	3500
LS	2.0	220	7.3	4.3	1.1	7500	6		○	EEFLS0D221R	3500
	2.5	180	7.3	4.3	1.1	7500	6		○	EEFLS0E181R	3500
ST	2.0	330	7.3	4.3	1.4	7500	6	○		EEFST0D331R	3500
	2.5	270	7.3	4.3	1.4	7500	6	○		EEFST0E271R	3500
LT	2.0	330	7.3	4.3	1.4	7500	6		○	EEFLT0D331R	3500
	2.5	270	7.3	4.3	1.4	7500	6		○	EEFLT0E271R	3500

*1: Ripple current (100 kHz / +45 °C)

*2: ESR (100 kHz / +20 °C)

*3: Please contact us when 500 pcs packing is necessary.

◆ Please refer to each page in this catalog for "Reflow conditions" and "Taping specifications".

Temperature coefficient of ripple current

Temperature		T ≤ 45 °C	45 °C < T ≤ 85 °C	85 °C < T ≤ 105 °C
2.0 V to 6.3 V	Coefficient	1.0	0.7	0.25

◆ Ripple current should be controlled so that surface temperature of capacitor does not exceed the category temperature.

**Conductive Polymer Aluminum
Electrolytic Capacitors**
Surface Mount Type

GY series [Super low ESR]

SP-Cap

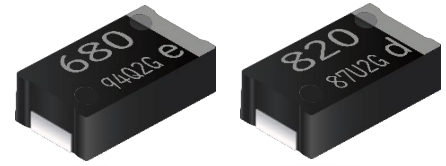

Features

- Super low ESR (3 mΩ max.)
- Large capacitance (820 μF max.)
- High ripple current (10200 mA rms max.)
- RoHS compliance, Halogen free

Specifications

Series	GY	
Category temp. range	-55 °C to +105 °C	
Rated voltage range	2.0 V to 2.5 V	
Rated cap. range	680 μF to 820 μF	
Capacitance tolerance	±20 % (120 Hz / +20 °C)	
DC leakage current	I ≤ 0.1 CV (μA) 2 minutes	
Dissipation factor (tan δ)	≤ 0.06 (120 Hz / + 20 °C)	
Surge voltage (V)	Rated voltage × 1.25 (15 °C to 35 °C)	
Endurance	+105 °C 2000 h, rated voltage applied	
	Capacitance change	Within ±20 % of the initial value
	Dissipation factor (tan δ)	≤ 2 times of the initial limit
	DC leakage current	≤ 3 times of the initial limit
Damp heat (Steady state)	+60 °C, 90 % RH, 500 h, No-applied voltage	
	Capacitance change of initial measured value	2.0 V to 2.5 V +70 %, -20 %
	Dissipation factor (tan δ)	≤ 2 times of the initial limit
	DC leakage current	Within the initial limit

Marking

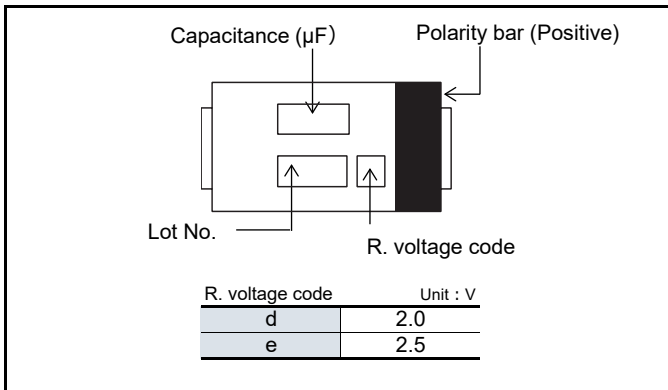

Dimensions (not to scale)

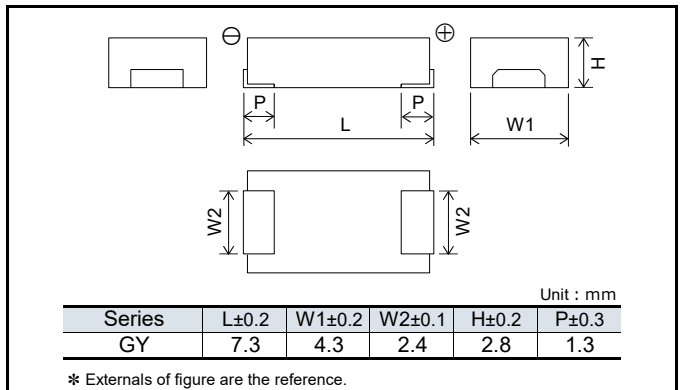

Characteristics list

Series	Rated voltage (V)	Capacitance (μF)	Case size (mm)			Specification		Part number	Min. Packaging Qty (pcs)
			L	W	H	Ripple current*1 (mA rms)	ESR*2 (mΩ max.)		
GY	2.0	820	7.3	4.3	2.8	10200	3	EEFGY0D821R	2000
	2.5	680	7.3	4.3	2.8	10200	3	EEFGY0E681R	2000

*1: Ripple current (100 kHz / +45 °C)

*2: ESR (100 kHz / +20 °C)

◆ Please refer to each page in this catalog for "Reflow conditions" and "Taping specifications".

Temperature coefficient of ripple current

Temperature	T ≤ 45 °C	45 °C < T ≤ 85 °C	85 °C < T ≤ 105 °C	
2.0 V to 2.5 V	Coefficient	1.0	0.7	0.25

◆ Ripple current should be controlled so that surface temperature of capacitor does not exceed the category temperature.

**Conductive Polymer Aluminum
Electrolytic Capacitors**
Surface Mount Type

CY/SY series [Guaranteed at 85 °C]

SP-Cap

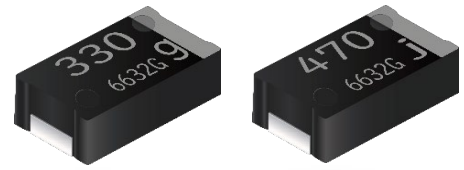

Features

- Endurance 85 °C 2000 h
- Product height (3.0 mm max.)
- High ripple current (5100 mA rms to 6300 mA rms max.)
- RoHS compliance, Halogen free

Specifications

Series	CY / SY		
Category temp. range	-55 °C to +85 °C		
Rated voltage range	4.0 V, 6.3V		
Rated cap. range	330 μF to 470 μF		
Capacitance tolerance	±20 % (120 Hz / +20 °C)		
DC leakage current	I ≤ 0.1 CV (μA) 2 minutes		
Dissipation factor (tan δ)	≤ 0.06 (120 Hz / + 20 °C)		
Surge voltage (V)	Rated voltage × 1.25 (15 °C to 35 °C)		
Endurance	+85 °C 2000 h, rated voltage applied		
	Capacitance change	Within ±20 % of the initial value	
	Dissipation factor (tan δ)	≤ 2 times of the initial limit	
	DC leakage current	≤ 3 times of the initial limit	
Damp heat (Steady state)	+60 °C, 90 % RH, 500 h, No-applied voltage		
	Capacitance change of initial measured value	4.0 V	6.3 V
		+60 %, -20 %	+50 %, -20 %
	Dissipation factor (tan δ)	≤ 2 times of the initial limit	
DC leakage current	Within the initial limit		

Marking

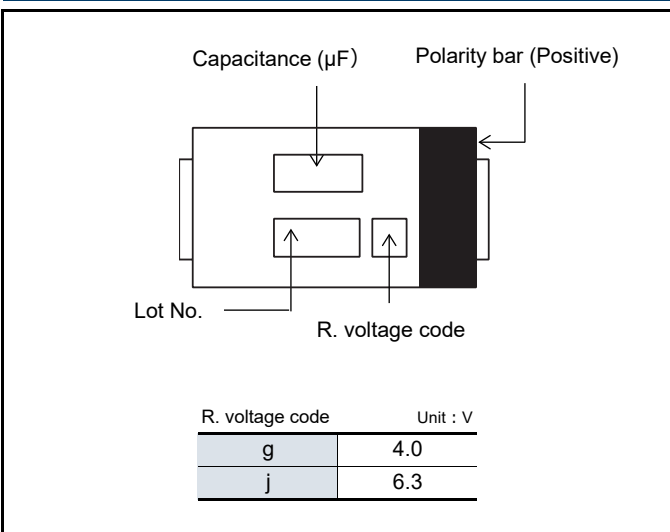

Dimensions (not to scale)

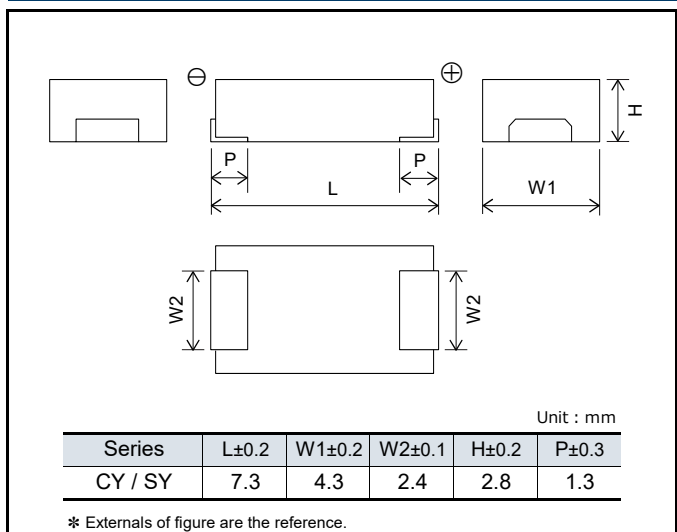

Characteristics list

Series	Rated voltage (V)	Capacitance (μF)	Case size (mm)			Specification		Part number	Min. Packaging Q'ty ^{*3} (pcs)
			L	W	H	Ripple current ^{*1} (mA rms)	ESR ^{*2} ($\text{m}\Omega$ max.)		
CY	4.0	470	7.3	4.3	2.8	5100	15	ECGCY0G471R	2000
	6.3	330	7.3	4.3	2.8	5100	15	ECGCY0J331R	2000
SY	4.0	470	7.3	4.3	2.8	6300	9	ECGSY0G471R	2000
	6.3	330	7.3	4.3	2.8	6300	9	ECGSY0J331R	2000

*1: Ripple current (100 kHz / +45 °C)

*2: ESR (100 kHz / +20 °C)

*3: Please contact us when 500 pcs packing is necessary.

◆ Please refer to each page in this catalog for "Reflow conditions" and "Taping specifications".

Temperature coefficient of ripple current

Temperature		$T \leq 45\text{ }^\circ\text{C}$	$45\text{ }^\circ\text{C} < T \leq 65\text{ }^\circ\text{C}$	$65\text{ }^\circ\text{C} < T \leq 85\text{ }^\circ\text{C}$
4.0 V to 6.3 V	Coefficient	1.0	0.7	0.25

◆ Ripple current should be controlled so that surface temperature of capacitor does not exceed the category temperature.

**Conductive Polymer Aluminum
Electrolytic Capacitors**
Surface Mount Type

JX series [High temperature long life product]

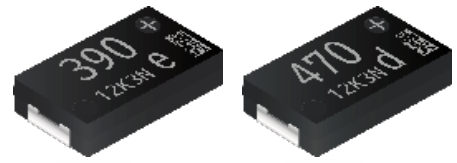

Features

- Endurance 125 °C 3000 h
- Damp heat 85°C 85% 1000 h
- Low ESR (9mΩ max.)
- RoHS compliance, Halogen free

Specifications

Series	JX	
Category temp. range	-55 °C to +125 °C	
Rated voltage range	2.0 V, 2.5 V	
Category voltage range	1.6 V, 2.0 V	
Rated cap. range	220 μF to 470 μF	
Capacitance tolerance	±20 % (120 Hz / +20 °C)	
DC leakage current	I ≤ 0.1 CV (μA) 2 minutes	
Dissipation factor (tan δ)	≤ 0.1 (120 Hz / + 20 °C)	
Surge voltage (V)	Rated voltage × 1.25 (15 °C to 35 °C)	
Endurance	+125 °C 3000 h, category voltage applied	
	Capacitance change	Within ±20 % of the initial value
	Dissipation factor (tan δ)	≤ 2 times of the initial limit
	DC leakage current	≤ 3 times of the initial limit
Damp heat (Steady state)	+85 °C, 85 % RH, 1000 h, No-applied voltage	
	Capacitance change of initial measured value	2.0 V, 2.5 V +70 %, -20 %
	Dissipation factor (tan δ)	≤ 2 times of the initial limit
	DC leakage current	≤ 5 times of the initial limit

Marking

Capacitance (μF) Polarity (Positive)

Lot No. R. voltage code 2D code *1

R. voltage code	Unit : V
d	2.0
e	2.5

*1: Internal management information

Dimensions (not to scale)

Series	L±0.2	W1±0.2	W2±0.1	H±0.1	P±0.3
JX	7.3	4.3	2.4	1.9	1.3

Unit : mm

* Externals of figure are the reference.

Characteristics list

Series	Rated voltage [105 °C] (V)	Category voltage [125 °C] (V)	Capacitance (μ F)	Case size (mm)			Specification		Part number	Min. Packaging Qty (pcs)
				L	W	H	Ripple current* ¹ (mA rms)	ESR* ² (m Ω max.)		
JX	2.0	1.6	330	7.3	4.3	1.9	6300	9	EEFJX0D331RE	3500
			470	7.3	4.3	1.9	6300	9	EEFJX0D471RE	3500
	2.5	2.0	220	7.3	4.3	1.9	6300	9	EEFJX0E221RE	3500
			330	7.3	4.3	1.9	6300	9	EEFJX0E331RE	3500
			390	7.3	4.3	1.9	6300	9	EEFJX0E391RE	3500

*1: Ripple current (100 kHz / +45 °C)

*2: ESR (100 kHz / +20 °C)

◆ Please refer to each page in this catalog for "Reflow conditions" and "Taping specifications".

Temperature coefficient of ripple current

Temperature		$T \leq 45 \text{ }^\circ\text{C}$	$45 \text{ }^\circ\text{C} < T \leq 85 \text{ }^\circ\text{C}$	$85 \text{ }^\circ\text{C} < T \leq 105 \text{ }^\circ\text{C}$	$105 \text{ }^\circ\text{C} < T \leq 125 \text{ }^\circ\text{C}$
2.0 V to 2.5 V	Coefficient	1.0	0.7	0.25	0.25

◆ Ripple current should be controlled so that surface temperature of capacitor does not exceed the category temperature.

**Conductive Polymer Aluminum
Electrolytic Capacitors**
Surface Mount Type

HX series [Guaranteed at 125 °C]

SP-Cap

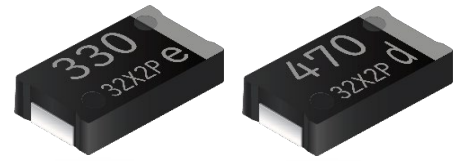

Features

- Endurance 125 °C 1000 h
- High voltage & Large capacitance
(2.0 V / 560 μF to 25 V / 33 μF)
- Low ESR (4.5 mΩ max.)
- RoHS compliance, Halogen free

• **2, 2.5 V : On sale**
 • **10 to 25 V : Not recommended for new design**
 ※ Click [here](#) for Replacement (10 to 25 V)

Specifications

Series		HX	
Category temp. range		-55 °C to +125 °C	
Rated voltage range		2.0 V to 2.5 V, 10 V to 25 V	
Category voltage range		1.6 V to 2.0 V, 8.0 V to 20 V	
Rated cap. range		15 μF to 470 μF	
Capacitance tolerance		±20 % (120 Hz / +20 °C)	
DC leakage current		I ≤ 0.1 CV(μA) [2.0 V to 2.5 V, 2 min], I ≤ 0.3 CV(μA) [10 V to 25 V, 2 min]	
Dissipation factor (tan δ)		≤ 0.1 (120 Hz / +20 °C)	
Surge voltage (V)		Rated voltage × 1.25 [2.0 V to 16 V], × 1.15 [20 V to 25 V] (15 °C to 35 °C)	
Endurance	+125 °C 1000 h, category voltage applied		
	Capacitance change	Within ±20 % of the initial value	
	Dissipation factor (tan δ)	≤ 2 times of the initial limit	
	DC leakage current	Within the initial limit	
Damp heat (Steady state)	After storing for 500 hours at +60 °C, 90 % RH		
	Capacitance change of initial measurd value	2.0 V to 2.5 V	10 V to 25 V
		+70 %, -20 %	
	Dissipation factor (tan δ)	≤ 2 times of the initial limit	
DC leakage current	Within the initial limit : 2.0 V to 2.5 V ≤ 3 times of the initial limit : 10 V to 25 V		

Marking

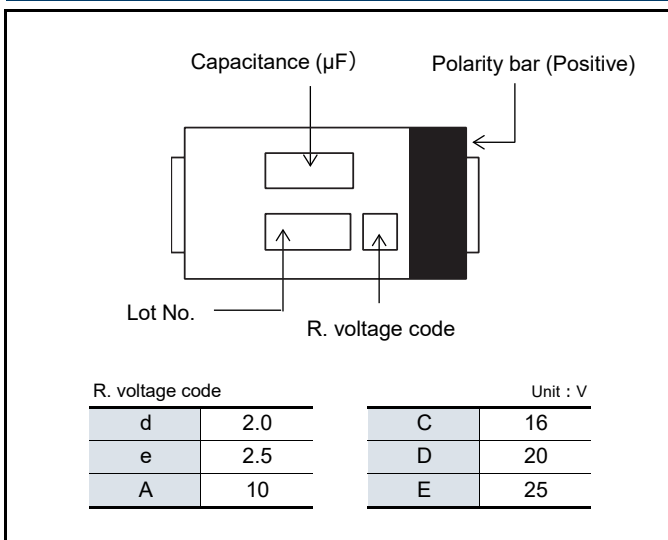

Dimensions (not to scale)

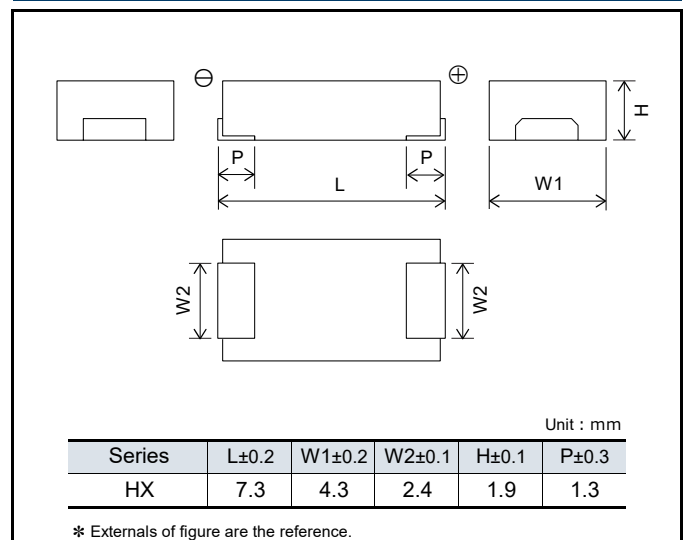

Characteristics list

■ 2.0 V to 2.5 V

Series	Rated voltage [105 °C] (V)	Category voltage [125 °C] (V)	Capacitance (μF)	Case size (mm)			Specification		Part number	Min. Packaging Q'ty ^{*3} (pcs)
				L	W	H	Ripple current ^{*1} (mA rms)	ESR ^{*2} (mΩ max.)		
HX	2.0	1.6	470	7.3	4.3	1.9	5100	15	EEFH0D471R	3500
				7.3	4.3	1.9	6300	9	EEFH0D471R9	3500
				7.3	4.3	1.9	7500	6	EEFH0D471R6	3500
				7.3	4.3	1.9	8500	4.5	EEFH0D471R4	3500
	2.5	2.0	330	7.3	4.3	1.9	5100	15	EEFH0E331R	3500
				7.3	4.3	1.9	6300	9	EEFH0E331R9	3500
				7.3	4.3	1.9	7500	6	EEFH0E331R6	3500
				7.3	4.3	1.9	8500	4.5	EEFH0E331R4	3500

■ 10 V to 25 V

Not Recommended for New Design

For replacement

Series	Rated voltage [105 °C] (V)	Category voltage [125 °C] (V)	Capacitance (μF)	Case size (mm)			Specification		Part number	Min. Packaging Q'ty ^{*3} (pcs)
				L	W	H	Ripple current ^{*1} (mA rms)	ESR ^{*2} (mΩ max.)		
HX	10	8.0	47	7.3	4.3	1.9	3200	40	EEFH1A470R	3500
			68	7.3	4.3	1.9	3200	40	EEFH1A680R	3500
			100	7.3	4.3	1.9	3200	40	EEFH1A101R	3500
	16	12.8	15	7.3	4.3	1.9	3200	40	EEFH1C150R	3500
			22	7.3	4.3	1.9	3200	40	EEFH1C220R	3500
			33	7.3	4.3	1.9	3200	40	EEFH1C330R	3500
			47	7.3	4.3	1.9	3200	40	EEFH1C470R	3500
			68	7.3	4.3	1.9	3200	40	EEFH1C680R	3500
	20	16	22	7.3	4.3	1.9	3200	40	EEFH1D220R	3500
			33	7.3	4.3	1.9	3200	40	EEFH1D330R	3500
			47	7.3	4.3	1.9	3200	40	EEFH1D470R	3500
			56	7.3	4.3	1.9	3200	40	EEFH1D560R	3500
	25	20	15	7.3	4.3	1.9	3200	40	EEFH1E150R	3500
			22	7.3	4.3	1.9	3200	40	EEFH1E220R	3500
			33	7.3	4.3	1.9	3200	40	EEFH1E330R	3500

*1: Ripple current (100 kHz / +45 °C)

*2: ESR (100 kHz / +20 °C)

*3: Please contact us when 500 pcs packing is necessary.

◆ Please refer to each page in this catalog for "Reflow conditions" and "Taping specifications".

Temperature coefficient of ripple current

Temperature		T ≤ 45 °C	45 °C < T ≤ 85 °C	85 °C < T ≤ 105 °C	105 °C < T ≤ 125 °C
2.0 V to 2.5 V	Coefficient	1.0	0.7	0.25	0.25
10 V to 25 V		1.0	0.8	0.5	0.25

◆ Ripple current should be controlled so that surface temperature of capacitor does not exceed the category temperature.

Replacement list for “Not recommended for new design”

* If you are using any of the following models on the deleted list, please substitute them with the suggested alternative model as soon as possible.

Non-recommended part number					Replacement part number								
Series	Cate-gory temp. range max. (°C)	Rated voltage (V)	Capaci-tance (µF)	ESR (mΩ)	Part number	Series	Size code	Cate-gory temp. range max. (°C)	Rated voltage (V)	Capaci-tance (µF)	ESR (mΩ)	Part number	
CS	105	10	47	40	EEFCS1A470R	POSCAP TQC	D12	105	16	33	40	16TQC33MYFS	
						POSCAP TPG	B1G	85	10	47	70	10TPG47M	
						OS-CON SVP	C6	105	10	47	50	10SVP47M	
						Hybrid ZA	D	105	25	47	50	EEHZA1E470P	
	105	16	15	40	EEFCS1C150R	POSCAP TQC	D12	105	16	33	40	16TQC33MYFS	
						OS-CON SVP	B6	105	16	22	90	16SVP22M	
						Hybrid ZA	C	105	25	22	80	EEHZA1E220R	
	105	16	22	40	EEFCS1C220R	POSCAP TQC	D12	105	16	33	40	16TQC33MYFS	
						OS-CON SVP	B6	105	16	22	90	16SVP22M	
						Hybrid ZA	C	105	25	22	80	EEHZA1E220R	
	105	16	33	40	EEFCS1C330R	POSCAP TQC	D12	105	16	33	40	16TQC33MYFS	
						OS-CON SVPC	B6	105	16	39	27	16SVP39MV	
						Hybrid ZA	C	105	25	33	80	EEHZA1E330R	
	105	20	10	40	EEFCS1D100R	POSCAP TQC	D15	105	20	47	55	20TQC47MYFT	
						OS-CON SVPA	B6	105	20	10	40	20SVPA10M	
						Hybrid ZA	C	105	35	10	100	EEHZA1V100R	
	105	20	15	40	EEFCS1D150R	POSCAP TQC	D15	105	20	47	55	20TQC47MYFT	
						OS-CON SVPB	C5	105	20	15	45	20SVPB15M	
						Hybrid ZA	C	105	25	22	80	EEHZA1E220R	
	105	20	22	40	EEFCS1D220R	POSCAP TQC	D15	105	20	47	55	20TQC47MYFT	
						OS-CON SVPA	C6	105	20	22	35	20SVPA22M	
						Hybrid ZA	C	105	25	22	80	EEHZA1E220R	
	105	25	10	40	EEFCS1E100R	POSCAP TQC	D15	105	25	22	70	25TQC22MYFT	
						POSCAP TQC	D2	105	25	15	45	25TQC15MV	
OS-CON SVPD						C6	125	25	10	65	25SVPD10M		
Hybrid ZA						C	105	35	10	100	EEHZA1V100R		
105	25	15	40	EEFCS1E150R	POSCAP TQC	D15	105	25	22	70	25TQC22MYFT		
					POSCAP TQC	D2	105	25	15	45	25TQC15MV		
					OS-CON SVPG	B45	105	25	15	30	25SVPG15M		
					Hybrid ZA	C	105	25	22	80	EEHZA1E220R		
105	35	10	40	EEFCS1V100R	POSCAP TQC	D2	105	35	10	120	35TQC10MYF		
					OS-CON SVPK	B6	125	35	22	35	35SVPK22M		
					Hybrid ZA	C	105	35	10	100	EEHZA1V100R		
CT	105	10	68	40	EEFCT1A680R	POSCAP TQC	D15	105	16	47	55	16TQC47MYFT	
						POSCAP TPE	D2E	105	10	68	25	10TPE68M	
						OS-CON SVPC	B6	105	10	68	30	10SVPC68M	
						Hybrid ZA	D8	105	25	68	30	EEHZA1E680XP	
	105	16	47	40	EEFCT1C470R	Hybrid ZA	D8	105	35	68	35	EEHZA1V680XP	
						POSCAP TQC	D15	105	16	47	55	16TQC47MYFT	
						OS-CON SVPG	B45	105	16	47	25	16SVPG47M	
	105	20	33	40	EEFCT1D330R	Hybrid ZA	D	105	25	47	50	EEHZA1E470P	
						POSCAP TQC	D15	105	20	47	55	20TQC47MYFT	
						OS-CON SVPG	B45	105	20	33	27	20SVPG33M	
	105	20	47	40	EEFCT1D470R	Hybrid ZA	C	105	25	33	80	EEHZA1E330R	
						POSCAP TQC	D15	105	20	47	55	20TQC47MYFT	
						OS-CON SVPF	C6	105	25	47	30	25SVPF47M	
	105	25	22	40	EEFCT1E220R	Hybrid ZA	D	105	25	47	50	EEHZA1E470P	
						POSCAP TQC	D15	105	25	22	70	25TQC22MYFT	
						POSCAP TQC	D2	105	25	22	45	25TQC22MV	
						OS-CON SVPF	B6	105	25	27	40	25SVPF27MX	
	105	35	15	40	EEFCT1V150R	Hybrid ZA	C	105	25	22	80	EEHZA1E220R	
						POSCAP TQC	D2	105	35	15	150	35TQC15MYF	
						OS-CON SVPK	B6	125	35	22	35	35SVPK22M	
							Hybrid ZA	C	105	35	22	100	EEHZA1V220R

Non-recommended part number						Replacement part number						
Series	Cate-gory temp. range max. (°C)	Rated voltage (V)	Capaci-tance (μF)	ESR (mΩ)	Part number	Series	Size code	Cate-gory temp. range max. (°C)	Rated voltage (V)	Capaci-tance (μF)	ESR (mΩ)	Part number
CX	105	10	100	40	EEFCX1A101R	POSCAP TPC	D2	105	10	100	45	10TPC100M
						OS-CON SVPC	C6	105	10	120	22	10SVPC120MV
						Hybrid ZA	D8	105	25	100	30	EEHZA1E101XP
	105	10	47	40	EEFCX1A470R	POSCAP TPE	D2E	105	10	68	25	10TPE68M
						POSCAP TPE	B2	85	10	47	35	10TPE47MAZB
						OS-CON SVP	C6	105	10	47	50	10SVP47M
						Hybrid ZA	D	105	25	47	50	EEHZA1E470P
	105	10	68	40	EEFCX1A680R	POSCAP TPE	D2E	105	10	68	25	10TPE68M
						POSCAP TQC	D2	105	16	68	50	16TQC68MYF
						OS-CON SVPC	B6	105	10	68	23	10SVPC68MV
						Hybrid ZA	D8	105	25	68	30	EEHZA1E680XP
	105	10	68	40	EEFCX1A680R	Hybrid ZA	D8	105	35	68	35	EEHZA1V680XP
						Hybrid ZA	D8	105	35	68	35	EEHZA1V680XP
	105	16	15	40	EEFCX1C150R	POSCAP TQC	D2	105	16	47	40	16TQC47MW
						POSCAP TQC	B2	105	16	15	90	16TQC15M
						OS-CON SVP	B6	105	16	22	90	16SVP22M
						Hybrid ZA	C	105	25	22	80	EEHZA1E220R
	105	16	22	40	EEFCX1C220R	POSCAP TQC	D2	105	16	47	40	16TQC47MW
						POSCAP TQC	B2	105	16	22	90	16TQC22MYFB
						OS-CON SVP	B6	105	16	22	90	16SVP22M
						Hybrid ZA	C	105	25	22	80	EEHZA1E220R
	105	16	33	40	EEFCX1C330R	POSCAP TQC	D2	105	16	47	40	16TQC47MW
						POSCAP TQC	B2	105	16	33	90	16TQC33MYFB
						OS-CON SVPC	B6	105	16	39	27	16SVPC39MV
						Hybrid ZA	C	105	25	33	80	EEHZA1E330R
	105	16	47	40	EEFCX1C470R	POSCAP TQC	D2	105	16	47	40	16TQC47MW
						OS-CON SVPG	B45	105	16	47	25	16SVPG47M
						Hybrid ZA	D	105	25	47	50	EEHZA1E470P
	105	16	68	40	EEFCX1C680R	POSCAP TQC	D2	105	16	68	50	16TQC68MYF
						POSCAP TQC	D2	105	16	100	50	16TQC100MYF
						OS-CON SVPC	C6	105	16	68	25	16SVPC68MV
						Hybrid ZA	D8	105	25	68	30	EEHZA1E680XP
	105	16	68	40	EEFCX1C680R	Hybrid ZA	D8	105	35	68	35	EEHZA1V680XP
						Hybrid ZA	D8	105	35	68	35	EEHZA1V680XP
	105	20	22	40	EEFCX1D220R	POSCAP TQC	D2	105	20	33	60	20TQC33MYFD
						POSCAP TQC	B2	105	20	22	90	20TQC22MYFB
						OS-CON SVPA	C6	105	20	22	35	20SVPA22M
						Hybrid ZA	C	105	25	22	80	EEHZA1E220R
	105	20	33	40	EEFCX1D330R	POSCAP TQC	D2	105	20	33	60	20TQC33MYFD
						POSCAP TQC	D2	105	20	47	55	20TQC47MYF
						OS-CON SVPG	B45	105	20	33	27	20SVPG33M
						Hybrid ZA	C	105	25	33	80	EEHZA1E330R
	105	20	47	40	EEFCX1D470R	POSCAP TQC	D15	105	20	47	55	20TQC47MYFT
						OS-CON SVPF	C6	105	25	47	30	25SVPF47M
						Hybrid ZA	D	105	25	47	50	EEHZA1E470P
	105	20	56	40	EEFCX1D560R	POSCAP TQC	D2	105	20	100	100	20TQC100MD2
						OS-CON SVPF	B6	105	20	56	30	20SVPF56MX
						Hybrid ZA	C	105	25	56	50	EEHZA1E560P
105	25	15	40	EEFCX1E150R	POSCAP TQC	D2	105	25	15	45	25TQC15MV	
					POSCAP TQC	B2	105	25	15	100	25TQC15MYFB	
					OS-CON SVPF	B45	105	25	15	30	25SVPG15M	
					Hybrid ZA	C	105	25	22	80	EEHZA1E220R	
105	25	22	40	EEFCX1E220R	POSCAP TQC	D2	105	25	22	45	25TQC22MV	
					OS-CON SVPF	B6	105	25	27	40	25SVPF27MX	
					Hybrid ZA	C	105	25	22	80	EEHZA1E220R	
105	25	33	40	EEFCX1E330R	POSCAP TQC	D2	105	25	33	60	25TQC33MYF	
					OS-CON SVPK	B6	125	25	33	35	25SVPK33M	
					Hybrid ZA	C	105	25	33	80	EEHZA1E330R	
105	35	15	40	EEFCX1V150R	POSCAP TQC	D2	105	35	15	150	35TQC15MYF	
					OS-CON SVPK	B6	125	35	22	35	35SVPK22M	
					Hybrid ZA	C	105	35	22	100	EEHZA1V220R	
105	35	22	40	EEFCX1V220R	POSCAP TQC	D2	105	35	15	150	35TQC15MYF	
					OS-CON SVPK	B6	125	35	22	35	35SVPK22M	
Hybrid ZA	C	105	35	22	100	EEHZA1V220R						

Non-recommended part number						Replacement part number						
Series	Cate-gory temp. range max. (°C)	Rated voltage (V)	Capaci-tance (µF)	ESR (mΩ)	Part number	Series	Size code	Cate-gory temp. range max. (°C)	Rated voltage (V)	Capaci-tance (µF)	ESR (mΩ)	Part number
HX	125	10	47	40	EEFHX1A470R	POSCAP TDC	D2	125	16	100	50	16TDC100MYF
						POSCAP THC	D2	105	10	68	45	10THC68M
						OS-CON SVPD	C6	125	10	56	45	10SVPD56M
						Hybrid ZC	D	125	25	47	50	EEHXC1E470P
	125	10	68	40	EEFHX1A680R	POSCAP TDC	D2	125	16	100	50	16TDC100MYF
						POSCAP THC	D2	105	10	68	45	10THC68M
						OS-CON SVPK	B6	125	20	68	30	20SVPK68M
						Hybrid ZC	D8	125	25	68	30	EEHXC1E680XP
	125	10	100	40	EEFHX1A101R	POSCAP TDC	D2	125	16	100	50	16TDC100MYF
						POSCAP TCF	D3L	105	10	150	15	10TCF150ML
						OS-CON SVPK	B6	125	16	100	27	16SVPK100M
						Hybrid ZC	D8	125	25	100	30	EEHXC1E101XP
	125	16	15	40	EEFHX1C150R	POSCAP TDC	D2	125	16	100	50	16TDC100MYF
						POSCAP TDC	B2	125	16	33	90	16TDC33MYFB
						Hybrid ZC	C	125	25	22	80	EEHXC1E220R
	125	16	22	40	EEFHX1C220R	POSCAP TDC	D2	125	16	100	50	16TDC100MYF
						POSCAP TDC	B2	125	16	33	90	16TDC33MYFB
						OS-CON SVPK	B6	125	35	22	35	35SVPK22M
						Hybrid ZC	C	125	25	22	80	EEHXC1E220R
	125	16	33	40	EEFHX1C330R	POSCAP TDC	D2	125	16	100	50	16TDC100MYF
						POSCAP TDC	B2	125	16	33	90	16TDC33MYFB
						OS-CON SVPK	B6	125	25	33	35	25SVPK33M
						Hybrid ZC	C	125	25	33	80	EEHXC1E330R
	125	16	47	40	EEFHX1C470R	POSCAP TDC	D2	125	16	100	50	16TDC100MYF
						OS-CON SVPK	C6	125	35	47	27	35SVPK47M
						Hybrid ZC	D	125	25	47	50	EEHXC1E470P
	125	16	68	40	EEFHX1C680R	POSCAP TDC	D2	125	16	100	50	16TDC100MYF
						OS-CON SVF	B6	125	16	82	27	16SVF82M
						Hybrid ZC	D8	125	25	68	30	EEHXC1E680XP
	125	20	22	40	EEFHX1D220R	POSCAP TDC	B2	125	20	22	90	20TDC22MYFB
						OS-CON SVPK	B6	125	35	22	35	35SVPK22M
						Hybrid ZC	C	125	25	22	80	EEHXC1E220R
	125	20	33	40	EEFHX1D330R	OS-CON SVPK	B6	125	25	33	35	25SVPK33M
						Hybrid ZC	C	125	25	33	80	EEHXC1E330R
	125	20	47	40	EEFHX1D470R	OS-CON SVPK	C6	125	35	47	27	35SVPK47M
						Hybrid ZC	D	125	25	47	50	EEHXC1E470P
	125	20	56	40	EEFHX1D560R	OS-CON SVF	B6	125	20	56	30	20SVF56M
						Hybrid ZC	D	125	25	56	50	EEHXC1E560P
	125	25	15	40	EEFHX1E150R	POSCAP TDC	D3L	125	25	68	70	25TDC68MYF
						POSCAP TDC	B2	125	25	15	100	25TDC15MYFB
OS-CON SPF						B6	125	25	27	40	25SVF27M	
Hybrid ZC						C	125	25	22	80	EEHXC1E220R	
125	25	22	40	EEFHX1E220R	POSCAP TDC	D3L	125	25	68	70	25TDC68MYF	
					OS-CON SVF	B6	125	25	27	40	25SVF27M	
					Hybrid ZC	C	125	25	22	80	EEHXC1E220R	
125	25	33	40	EEFHX1E330R	POSCAP TDC	D3L	125	25	68	70	25TDC68MYF	
					OS-CON SVPK	B6	125	25	33	35	25SVPK33M	
					Hybrid ZC	C	125	25	33	80	EEHXC1E330R	

Safety Precautions

When using our products, no matter what sort of equipment they might be used for, be sure to confirm the applications and environmental conditions with our specifications in advance.

Panasonic
INDUSTRY

Panasonic Corporation
Device Solutions Business Division
Industrial Company
1006 Kadoma, Kadoma City, Osaka
571-8506 Japan