

HEXFET® Power MOSFET

V_{DS}	30	V
$V_{GS\ max}$	± 20	V
$R_{DS(on)\ max}$ (@ $V_{GS} = 10V$)	14.9	mΩ
(@ $V_{GS} = 4.5V$)	20.4	
$Q_g\ typ$	6.7	nC
I_D (@ $T_{c(Bottom)} = 25°C$)	10 ⑦	A

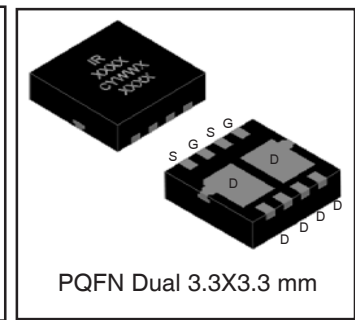
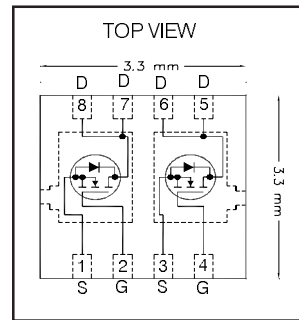

Applications

- Power Stage for high frequency buck converters
- Battery Protection charge and discharge switches

Features and Benefits

Features

Low Thermal Resistance to PCB (< 6.7°C/W)
Low Profile (<1.0mm)
Industry-Standard Pinout
Compatible with Existing Surface Mount Techniques
RoHS Compliant Containing no Lead, no Bromide and no Halogen
MSL1, Industrial Qualification

results in

⇒

Benefits

Enable better thermal dissipation
Increased Power Density
Multi-Vendor Compatibility
Easier Manufacturing
Environmentally Friendlier
Increased Reliability

Orderable part number	Package Type	Standard Pack		Note
		Form	Quantity	
IRFHM8363TRPBF	PQFN Dual 3.3mm x 3.3mm	Tape and Reel	4000	
IRFHM8363TR2PBF	PQFN Dual 3.3mm x 3.3mm	Tape and Reel	400	EOL notice #259

Absolute Maximum Ratings

	Parameter	Max.	Units
V_{DS}	Drain-to-Source Voltage	30	V
V_{GS}	Gate-to-Source Voltage	± 20	
$I_D @ T_A = 25°C$	Continuous Drain Current, $V_{GS} @ 10V$	11	A
$I_D @ T_A = 70°C$	Continuous Drain Current, $V_{GS} @ 10V$	8.6	
$I_D @ T_{C(Bottom)} = 25°C$	Continuous Drain Current, $V_{GS} @ 10V$	29⑥⑦	
$I_D @ T_{C(Bottom)} = 100°C$	Continuous Drain Current, $V_{GS} @ 10V$	18⑥⑦	
$I_D @ T_C = 25°C$	Continuous Drain Current, $V_{GS} @ 10V$ (Package Limited)	10⑦	
I_{DM}	Pulsed Drain Current ①	116	
$P_D @ T_A = 25°C$	Power Dissipation ②	2.7	W
$P_D @ T_{C(Bottom)} = 25°C$	Power Dissipation	19	
	Linear Derating Factor	0.02	W/°C
T_J T_{STG}	Operating Junction and Storage Temperature Range	-55 to + 150	°C

Notes ① through ⑦ are on page 9

Static @ T_J = 25°C (unless otherwise specified)

	Parameter	Min.	Typ.	Max.	Units	Conditions	
BV _{DSS}	Drain-to-Source Breakdown Voltage	30	—	—	V	V _{GS} = 0V, I _D = 250μA	
ΔBV _{DSS} /ΔT _J	Breakdown Voltage Temp. Coefficient	—	0.022	—	V/°C	Reference to 25°C, I _D = 1.0mA	
R _{DS(on)}	Static Drain-to-Source On-Resistance	—	12.2	14.9	mΩ	V _{GS} = 10V, I _D = 10A ③	
		—	16.3	20.4		V _{GS} = 4.5V, I _D = 8.0A ③	
V _{GS(th)}	Gate Threshold Voltage	1.35	1.8	2.35	V	V _{DS} = V _{GS} , I _D = 25μA	
ΔV _{GS(th)}	Gate Threshold Voltage Coefficient	—	-6.3	—	mV/°C		
I _{DSS}	Drain-to-Source Leakage Current	—	—	1.0	μA	V _{DS} = 24V, V _{GS} = 0V	
		—	—	150		V _{DS} = 24V, V _{GS} = 0V, T _J = 125°C	
I _{GSS}	Gate-to-Source Forward Leakage	—	—	100	nA	V _{GS} = 20V	
	Gate-to-Source Reverse Leakage	—	—	-100		V _{GS} = -20V	
g _{fs}	Forward Transconductance	20	—	—	S	V _{DS} = 10V, I _D = 10A	
Q _g	Total Gate Charge	—	15	—	nC	V _{GS} = 10V, V _{DS} = 15V, I _D = 10A	
Q _g	Total Gate Charge	—	6.7	—	nC	V _{DS} = 15V V _{GS} = 4.5V I _D = 10A	
	Q _{gs1}	Pre-V _{th} Gate-to-Source Charge	—	2.1			—
	Q _{gs2}	Post-V _{th} Gate-to-Source Charge	—	1.0			—
	Q _{gd}	Gate-to-Drain Charge	—	2.0			—
	Q _{godr}	Gate Charge Overdrive	—	1.6			—
Q _{sw}	Switch Charge (Q _{gs2} + Q _{gd})	—	3.0	—	nC		
Q _{oss}	Output Charge	—	7.6	—	nC	V _{DS} = 24V, V _{GS} = 0V	
R _G	Gate Resistance	—	1.6	—	Ω		
t _{d(on)}	Turn-On Delay Time	—	14	—	ns	V _{DD} = 15V, V _{GS} = 4.5V I _D = 10A R _G = 1.8Ω	
t _r	Rise Time	—	94	—			
t _{d(off)}	Turn-Off Delay Time	—	12	—			
t _f	Fall Time	—	33	—			
C _{iss}	Input Capacitance	—	1165	—	pF	V _{GS} = 0V V _{DS} = 10V f = 1.0MHz	
C _{oss}	Output Capacitance	—	260	—			
C _{rss}	Reverse Transfer Capacitance	—	100	—			

Avalanche Characteristics

	Parameter	Typ.	Max.	Units
E _{AS}	Single Pulse Avalanche Energy ②	—	29	mJ
I _{AR}	Avalanche Current ①	—	10	A

Diode Characteristics

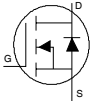
	Parameter	Min.	Typ.	Max.	Units	Conditions
I _S	Continuous Source Current (Body Diode)	—	—	10 ⑦	A	MOSFET symbol showing the integral reverse p-n junction diode. 
I _{SM}	Pulsed Source Current (Body Diode) ①	—	—	116		
V _{SD}	Diode Forward Voltage	—	—	1.3	V	T _J = 25°C, I _S = 10A, V _{GS} = 0V ③
t _{rr}	Reverse Recovery Time	—	17	26	ns	T _J = 25°C, I _F = 10A, V _{DD} = 15V
Q _{rr}	Reverse Recovery Charge	—	24	36	nC	di/dt = 280A/μs ③
t _{on}	Forward Turn-On Time	Time is dominated by parasitic inductance				

Thermal Resistance

	Parameter	Typ.	Max.	Units
R _{θJC} (Bottom)	Junction-to-Case ④	—	6.7	°C/W
R _{θJC} (Top)	Junction-to-Case ④	—	72	
R _{θJA}	Junction-to-Ambient ⑤	—	47	
R _{θJA} (<10s)	Junction-to-Ambient ⑤	—	32	

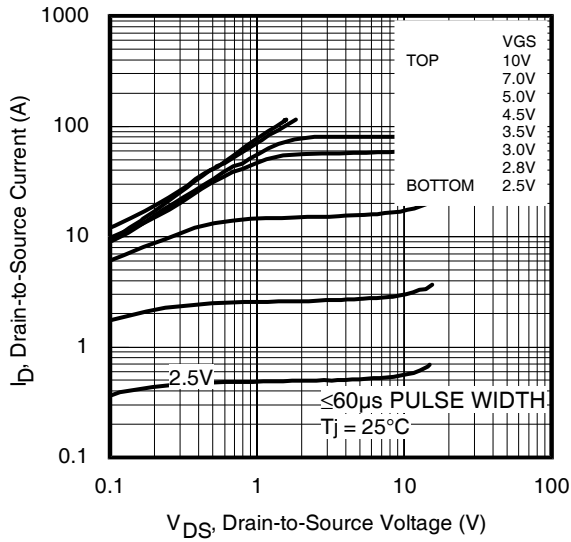
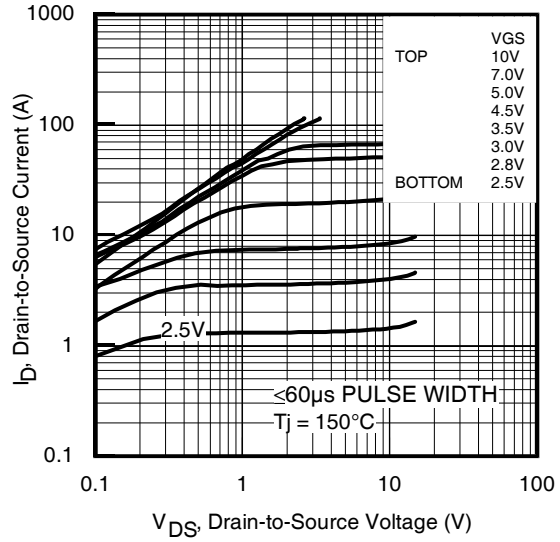
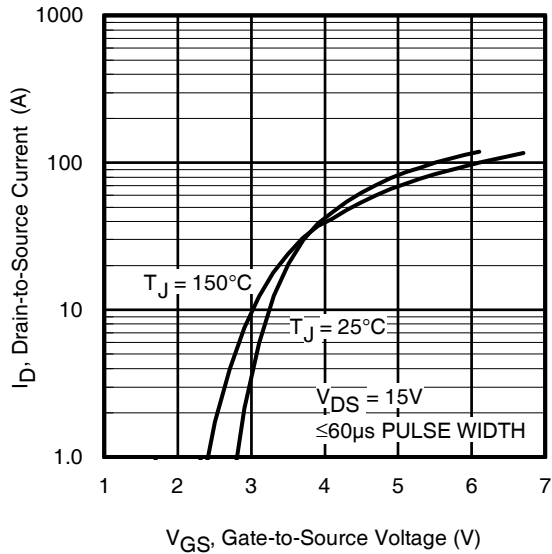
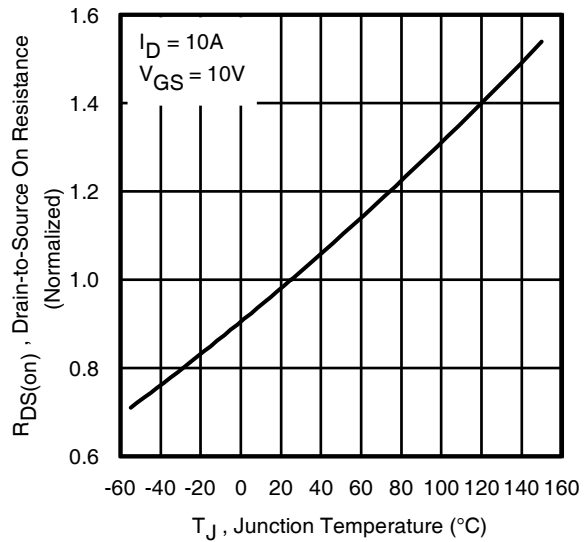
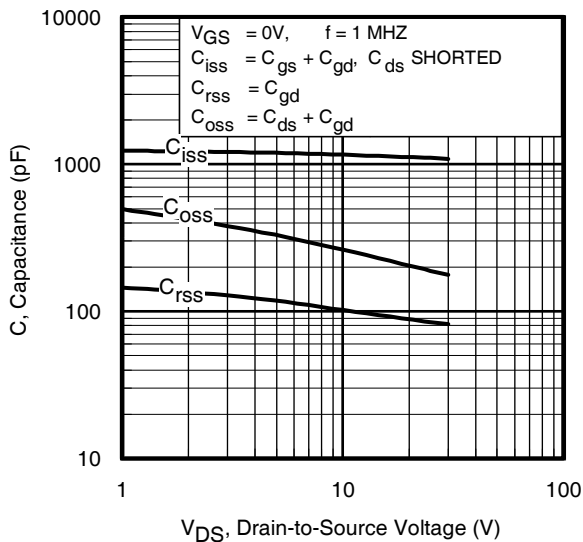
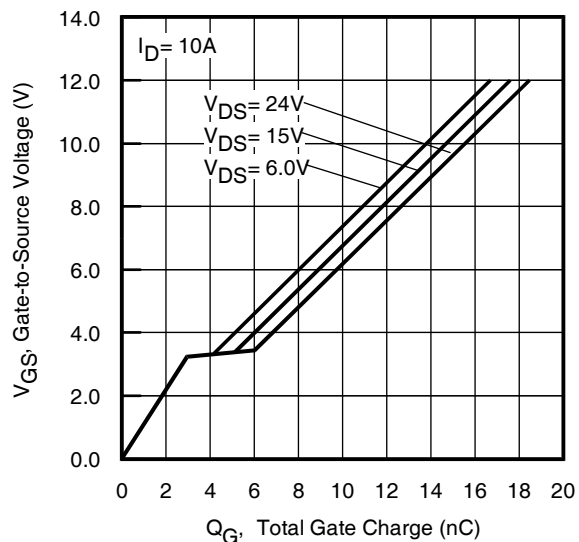
Fig 1. Typical Output Characteristics

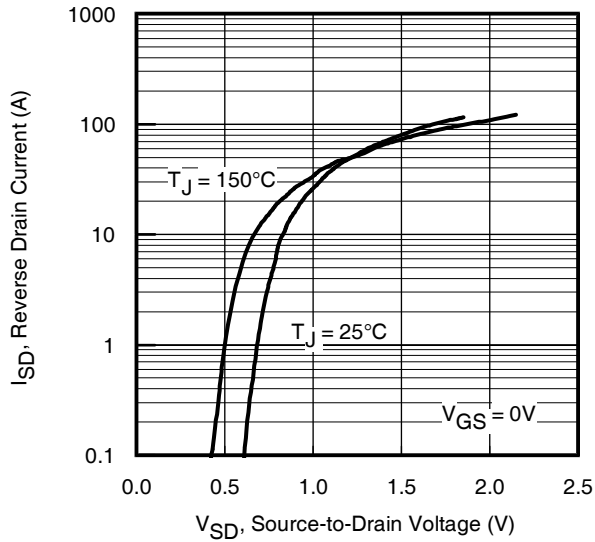
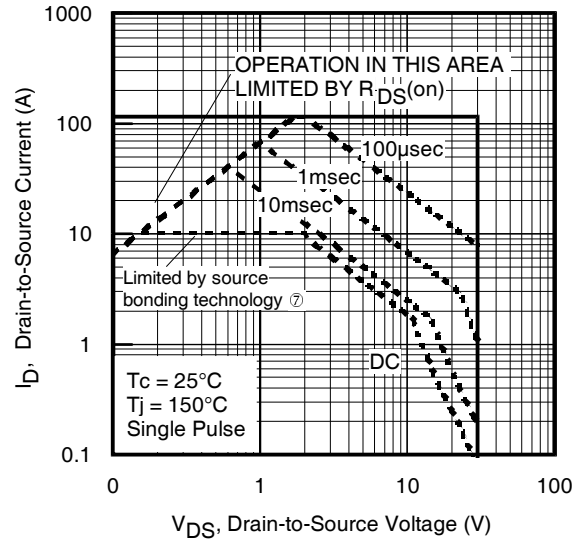
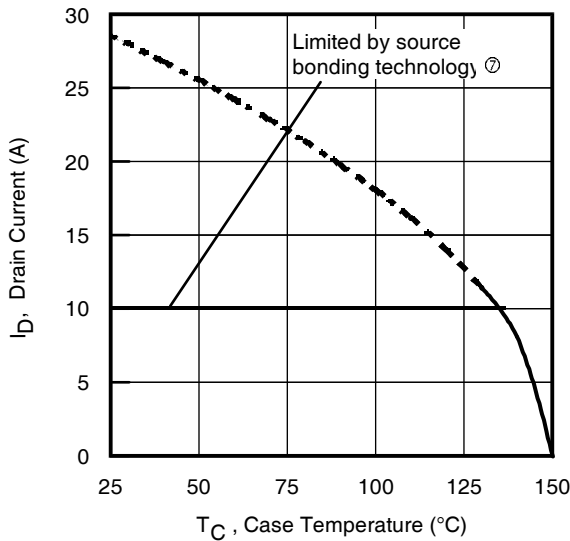
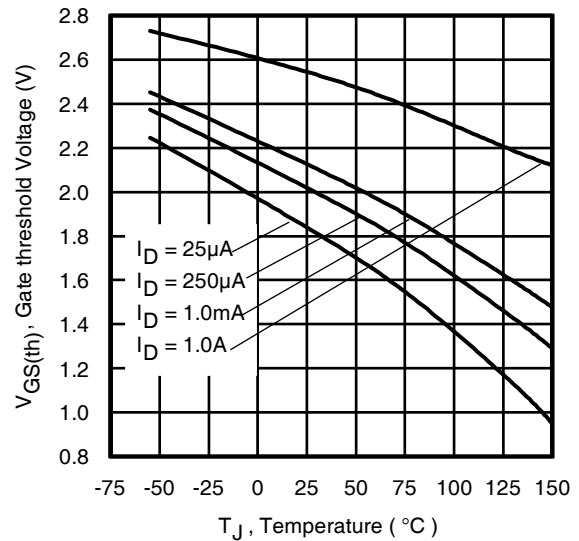
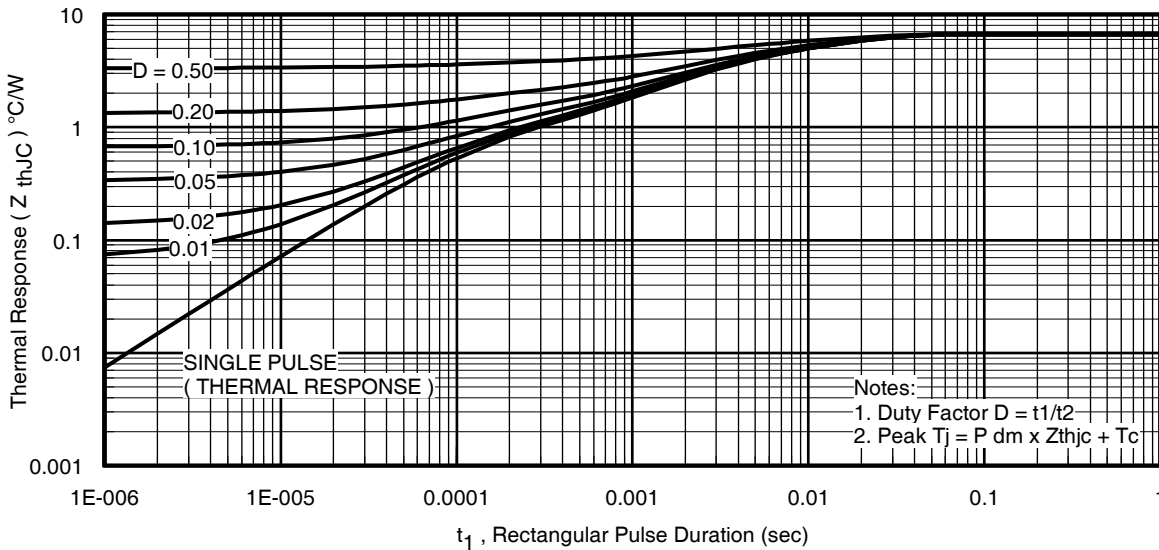
Fig 2. Typical Output Characteristics

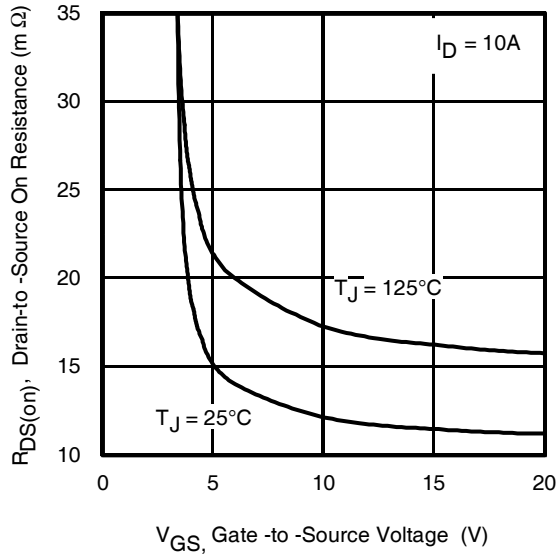
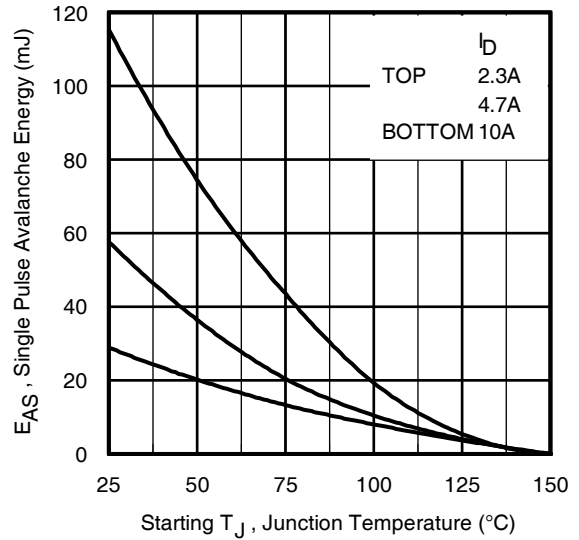
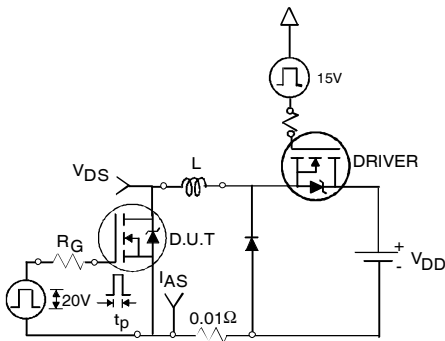
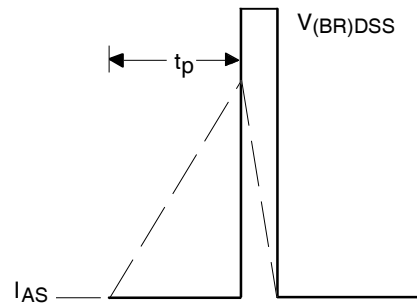
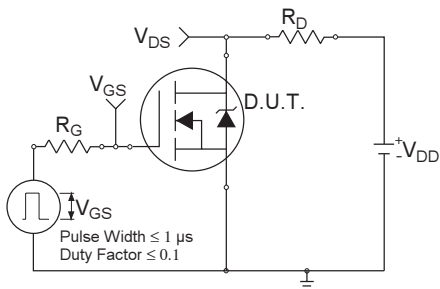
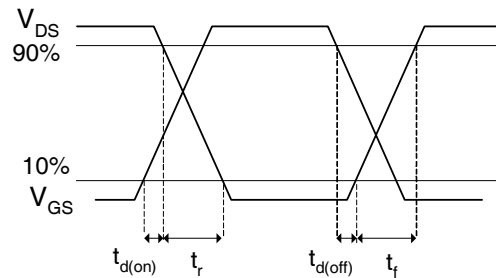
Fig 3. Typical Transfer Characteristics

Fig 4. Normalized On-Resistance vs. Temperature

Fig 5. Typical Capacitance vs. Drain-to-Source Voltage

Fig 6. Typical Gate Charge vs. Gate-to-Source Voltage

Fig 7. Typical Source-Drain Diode Forward Voltage

Fig 8. Maximum Safe Operating Area

Fig 9. Maximum Drain Current vs. Case (Bottom) Temperature

Fig 10. Threshold Voltage vs. Temperature

Fig 11. Maximum Effective Transient Thermal Impedance, Junction-to-Case (Bottom)

Fig 12. On-Resistance vs. Gate Voltage

Fig 13. Maximum Avalanche Energy vs. Drain Current

Fig 14a. Unclamped Inductive Test Circuit

Fig 14b. Unclamped Inductive Waveforms

Fig 15a. Switching Time Test Circuit

Fig 15b. Switching Time Waveforms

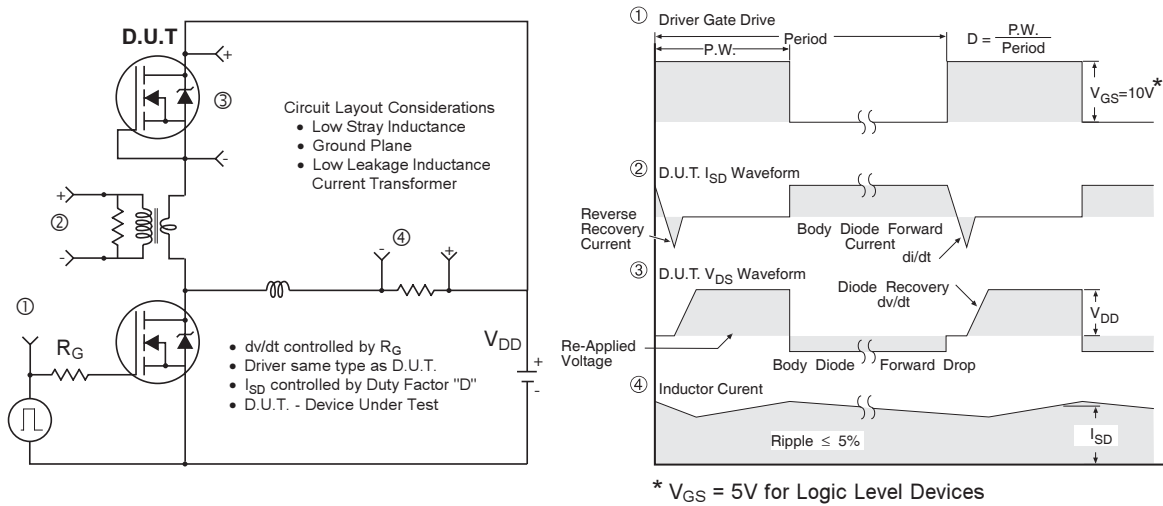

Fig 16. Peak Diode Recovery dv/dt Test Circuit for N-Channel HEXFET® Power MOSFETs

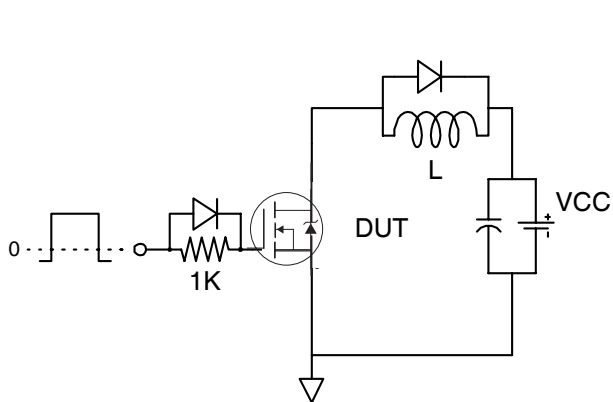

Fig 17. Gate Charge Test Circuit

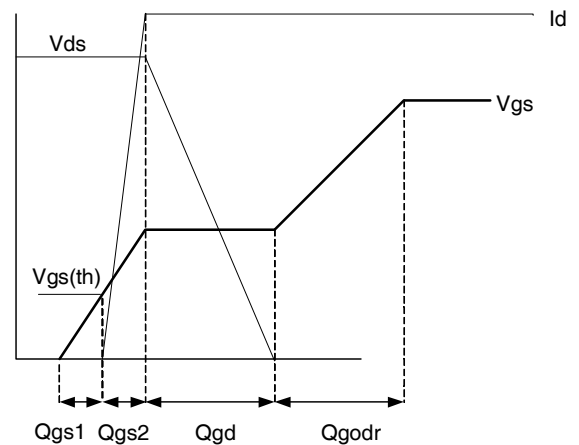
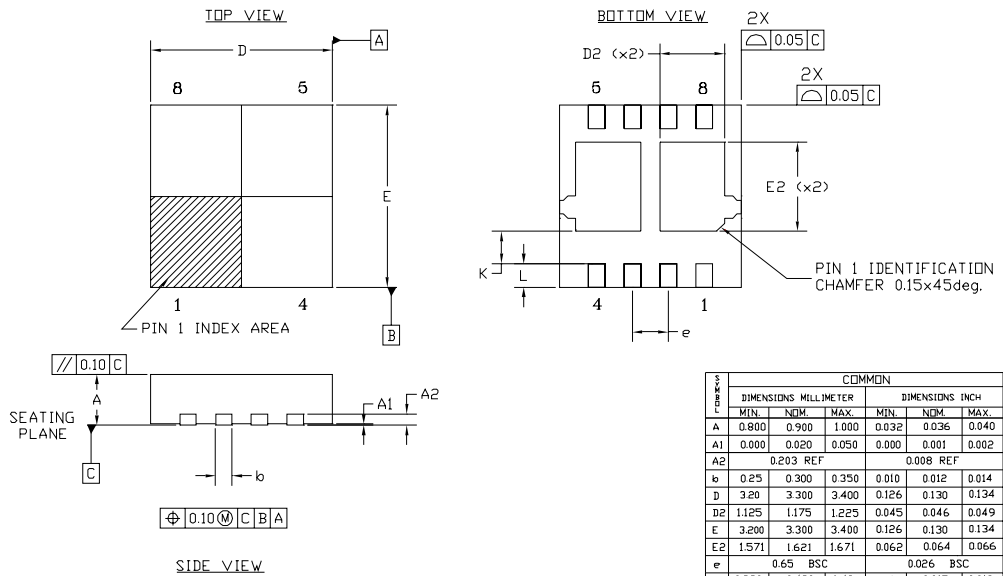

Fig 18. Gate Charge Waveform

PQFN Dual 3.3 x 3.3 Package Details



- NOTES :
1. DIMENSION AND TOLERANCING CONFORM TO ASME Y14.5M-1994.
 2. CONTROLLING DIMENSIONS - MILLIMETER. CONVERTED INCH DIMENSION ARE NOT NECESSARILY EXACT.
 3. DIMENSION b APPLIES TO METALLIZED TERMINAL AND IS MEASURED BETWEEN 0.15 AND 0.30 mm FROM TERMINAL TIP.

For more information on board mounting, including footprint and stencil recommendation, please refer to application note AN-1136: <http://www.irf.com/technical-info/appnotes/an-1136.pdf>

For more information on package inspection techniques, please refer to application note AN-1154: <http://www.irf.com/technical-info/appnotes/an-1154.pdf>

PQFN Dual 3.3 x 3.3 Part Marking

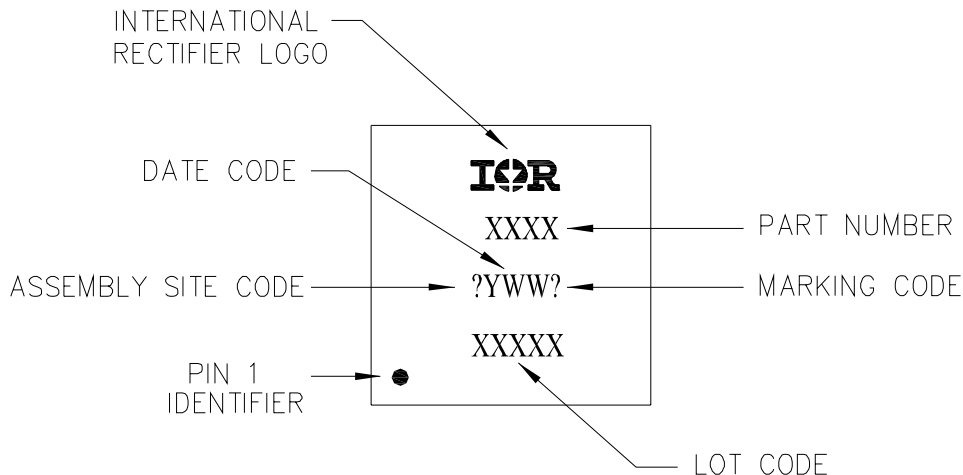

Note: For the most current drawing please refer to IR website at: <http://www.irf.com/package/>

PQFN Dual 3.3x3.3 Tape and Reel

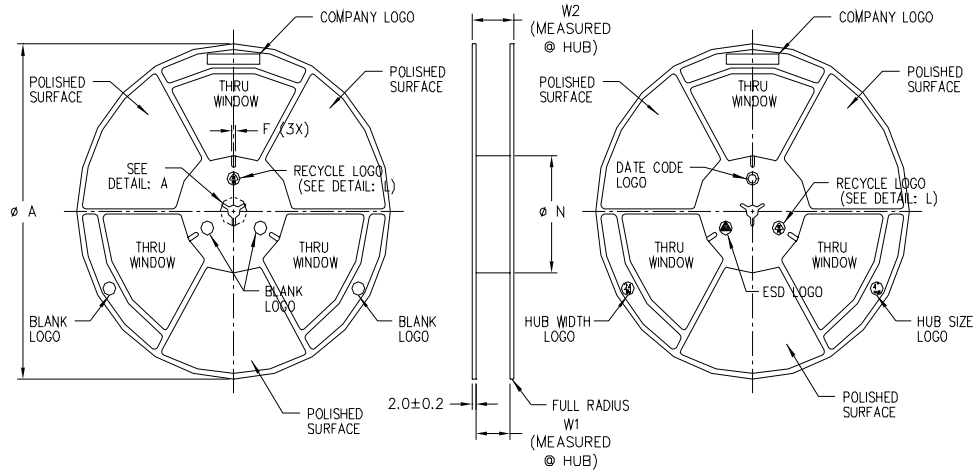
NOTES:

1. GENERIC PRODUCT.
2. FOR PRODUCT DRAWING ONLY.
3. SUNBLAST ALL SURFACE UNLESS OTHERWISE STATED.
4. MOLD 2

LEGEND	SURFACE SR RANGE	RESISTIVITY TYPE	COLOUR
A	BELOW 10^{12}	ANTISTATIC	ALL TYPES
B	10^6 TO 10^{11}	STATIC DISSIPATIVE	BLACK ONLY
C	10^5 & BELOW 10^5	CONDUCTIVE (GENERIC)	BLACK ONLY
D	10^5 TO 10^9	CONDUCTIVE (CUSTOM)	BLACK ONLY
E	BELOW 10^{12}	COATED ANTISTATIC	ALL COLOR

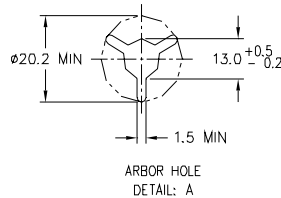
DETAIL: L

ANTISTATIC (ALL COLORS) STATIC (BLACK) DISSIPATIVE (BLACK) CONDUCTIVE (BLACK)

TAPE WIDTH	PRODUCT SPECIFICATION				
	ϕ A ± 2.0	ϕ N ± 2.0	W1	W2 (MAX)	E (MIN)
08MM	330	100	$8.4^{+1.5}_{-0.0}$	14.4	2.5
12MM	330	100	$12.4^{+2.0}_{-0.0}$	18.4	2.5
16MM	330	100	$16.4^{+2.0}_{-0.0}$	22.4	2.5
24MM	330	100	$24.4^{+2.0}_{-0.0}$	30.4	2.5
32MM	330	100	$32.4^{+2.0}_{-0.0}$	38.4	2.5

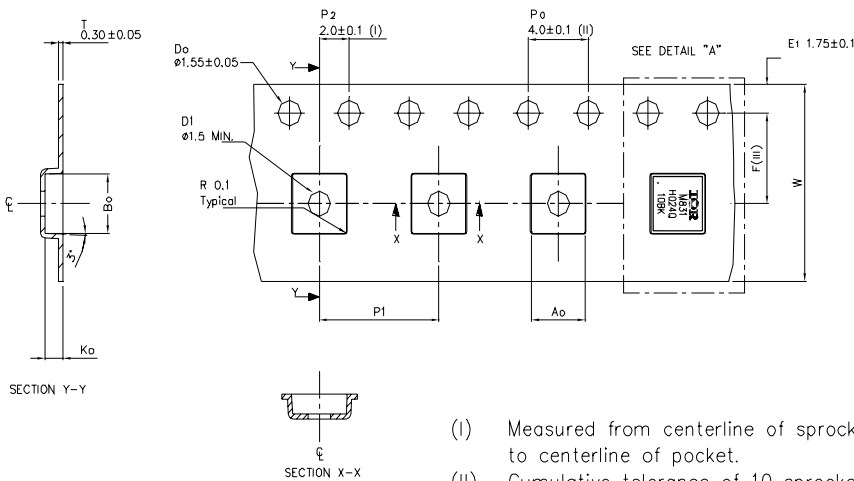

A ₀	3.60 +/- 0.1
B ₀	3.60 +/- 0.1
K ₀	1.20 +/- 0.1
F	5.50 +/- 0.1
P ₁	8.00 +/- 0.1
W	12.00 +/- 0.3

- (I) Measured from centerline of sprocket hole to centerline of pocket.
- (II) Cumulative tolerance of 10 sprocket holes is ± 0.20 .
- (III) Measured from centerline of sprocket hole to centerline of pocket.
- (IV) Other material available.
- (V) Typical SR of form tape Max 10^9 OHM/SQ

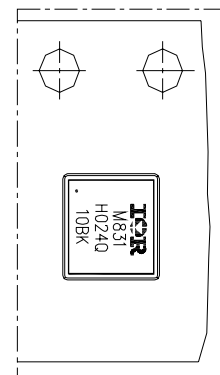
DETAIL "A"

Qualification information[†]

Qualification level	Industrial (per JEDEC JESD47F ^{†††} guidelines)	
Moisture Sensitivity Level	PQFN Dual 3.3mm x 3.3mm	MSL1 (per JEDEC J-STD-020D ^{††})
RoHS compliant	Yes	

† Qualification standards can be found at International Rectifier's web site
<http://www.irf.com/product-info/reliability>

†† Applicable version of JEDEC standard at the time of product release.

Notes:

- ① Repetitive rating; pulse width limited by max. junction temperature.
- ② Starting $T_J = 25^\circ\text{C}$, $L = 0.58\text{mH}$, $R_G = 50\Omega$, $I_{AS} = 10\text{A}$.
- ③ Pulse width $\leq 400\mu\text{s}$; duty cycle $\leq 2\%$.
- ④ R_θ is measured at T_J of approximately 90°C .
- ⑤ When mounted on 1 inch square PCB (FR-4). Please refer to AN-994 for more details:
<http://www.irf.com/technical-info/appnotes/an-994.pdf>
- ⑥ Calculated continuous current based on maximum allowable junction temperature.
- ⑦ Current is limited to 10A by source bonding technology.

Revision History

Date	Comment
1/9/2014	<ul style="list-style-type: none"> • Updated ordering information to reflect the End-Of-Life (EOL) of the mini-reel option (EOL notice #259). • Updated data sheet with the new IR corporate template.
2/4/2014	<ul style="list-style-type: none"> • Change the qualification level from Consumer to Industrial, on pages 1 & 9.

IMPORTANT NOTICE

The information given in this document shall in no event be regarded as a guarantee of conditions or characteristics ("Beschaffheitsgarantie").

With respect to any examples, hints or any typical values stated herein and/or any information regarding the application of the product, Infineon Technologies hereby disclaims any and all warranties and liabilities of any kind, including without limitation warranties of non-infringement of intellectual property rights of any third party.

In addition, any information given in this document is subject to customer's compliance with its obligations stated in this document and any applicable legal requirements, norms and standards concerning customer's products and any use of the product of Infineon Technologies in customer's applications.

The data contained in this document is exclusively intended for technically trained staff. It is the responsibility of customer's technical departments to evaluate the suitability of the product for the intended application and the completeness of the product information given in this document with respect to such application.

For further information on the product, technology, delivery terms and conditions and prices please contact your nearest Infineon Technologies office (www.infineon.com).

WARNINGS

Due to technical requirements products may contain dangerous substances. For information on the types in question please contact your nearest Infineon Technologies office.

Except as otherwise explicitly approved by Infineon Technologies in a written document signed by authorized representatives of Infineon Technologies, Infineon Technologies' products may not be used in any applications where a failure of the product or any consequences of the use thereof can reasonably be expected to result in personal injury.