

JU1215 炬

18V/10W Series



Introduction

Everlight's JU1215 18V/10W Series is a ceramic substrate based LED achieving high efficiency while maintaining high CRI at Energy Star / ANSI color temperature ranges.

Features

- ◆ High Power COB & High CRI LED
- ◆ Multi-Chip Solution
- ◆ Dimension: 12 mm x 15 mm x 1.6 mm
- ◆ Main Parameters: Luminous Flux, Forward Voltage, Chromaticity and Color Rendering Index
- ◆ RoHS compliant
- ◆ Energy Star / ANSI Compliant Binning Structure
- ◆ Typical Viewing Angle: 115°

Applications

- ◆ Replacement Bulb
- ◆ Indoor General Lighting
- ◆ Recessed Can Lighting

Table of Contents

Table of Contents.....	2
Product Nomenclature	3
Absolute Maximum Ratings	4
PN of the JU1215 18V/10W series:White LEDs.....	5
Product Binning:Luminous Flux Bins	6
Product Binning:White Bin Structure	7
Product Binning:Warm White Bin Structure	8
Product Binning:Warm White Bin Coordinates.....	8
Product Binning:Neutral White Bin Structure	9
Product Binning:Neutral White Bin Coordinates	9
Product Binning:Cool White Bin Structure.....	10
Product Binning:Cool White Bin Coordinates.....	11
Product Binning:Forward Voltage Bins	12
Mechanical Dimension	13
Pad Configuration.....	14
Typical Electro-Optical Characteristic Curve	15
Product Labeling	20
Carrier Tray Specification	20
Precautions of Use	22
Revision History	24

Product Nomenclature

The product name is designated as below:

JU1215-CDEFGHJ-KLMNP-QRST

Family name
JU1215

Designation:

CD = lighting color and wavelength^[1]

EF = color bin or CCT bin

G = internal code

HJ = min. luminous flux (lm) or radiation power (mW) performance

KL = forward voltage bin^[2]

M = internal code

NP = power consumption^[3]

Q= internal code

R= Dam Diameter^[4]

S= internal code

T=Type of Package^[5]

Notes

1. Table of lighting color and wavelength

Symbol	Color	CCT range	Color Rendering Index
GT	Cool-White	4745~7050K	>65
KT	Cool-White	4745~7050K	>80
LM	Warm-White	2580~3710K	>70
	Neutral-White	3710K-4745K	
KM	Warm White	2580~3710K	>80
	Neutral-White	3710K-4745K	

2. Table of forward voltage bin

Symbol	Description
18	18V Input Voltage

3. Power consumption:

Symbol	Description
10	10W

4. Dam Diameter:

Symbol	Description
A	10.0-10.9mm

5. Table of packaging types:

Symbol	Description
T	Tray

Absolute Maximum Ratings

Parameter	Symbol	Ratings	Unit
Max. DC Forward Current (mA)	I_F	550 _[1]	mA
Max. Peak Pulse Current (mA)	I_{Pulse}	900 _[2]	mA
Power Dissipation	P_d	10	W
Thermal Resistance(junction to board)	R_{th}	2.2	°C/W
Max. Junction Temperature	T_J	115	°C
Operating Temperature	T_{Opr}	-40 ~ +85	°C
Storage Temperature	T_{Stg}	-40 ~ +85	°C

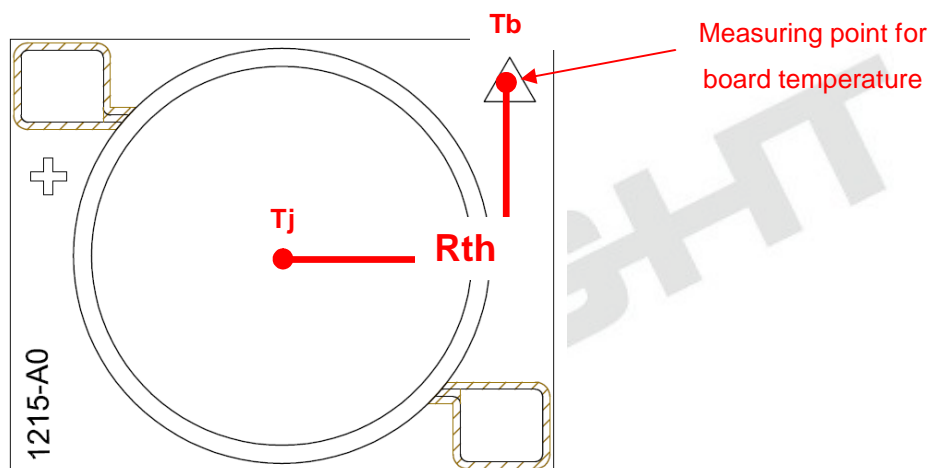

Notes:

1. For optimal performance, Everlight recommends 550mA operation.
2. t_p 100ms, Duty cycle = 25%
3. The JU1215 18V/10W series LEDs are not designed for reverse bias use.

PN of the JU1215 18V/10W series: White LEDs



Color	Order Code of JU1215	Minimum Luminous Flux (lm)	Typical Luminous Flux (lm)	CCT (K)	Forward Voltage (V)	Forward Current (mA)	CRI (min)
Warm White 2700	JU1215-KM277P1-18610-0A 0T	900	1065	27K-1~27K-4	16.0~20.0	550	80
Warm White 3000	JU1215-KM307P2-18610-0A0T	1000	1110	30K-1~30K-4	16.0~20.0	550	80
Neutral White 4000	JU1215-KM407P2-18610-0A0T	1000	1155	40K-1~40K-4	16.0~20.0	550	80
Cool White 5000	JU1215-KT507P3-18610-0A0T	1100	1210	50K-1~50K-4	16.0~20.0	550	80
Cool White 5700	JU1215-KT577P3-18610-0A0T	1100	1210	57K-1~57K-4	16.0~20.0	550	80
Cool White 6500	JU1215-KT657P3-18610-0A0T	1100	1210	65K-1~65K-4	16.0~20.0	550	80

Notes:

1. CRI measurement tolerance: ± 2 .
2. Luminous flux measurement tolerance: $\pm 10\%$.
3. The data of luminous flux measured at thermal pad=25
4. Typical luminous flux or light output performance is operated within the condition guided by this datasheet.

Product Binning

Luminous Flux Bins

Group	Bin	Minimum Photometric Flux (lm)	Maximum Photometric Flux (lm)
E	1	4	5
	2	5	6
	3	6	8
	4	8	10
	5	10	13
	6	13	17
	7	17	20
	8	20	23
	9	23	27
F	1	27	33
	2	33	39
	3	39	45
	4	45	52
	5	52	60
	6	60	70
	7	70	80
	8	80	90
	9	90	100

Group	Bin	Minimum Photometric Flux (lm)	Maximum Photometric Flux (lm)
J	1	100	110
	2	110	120
	3	120	130
	4	130	140
	5	140	150
	6	150	160
	7	160	180
	8	180	200
	9	200	225
K	1	225	250
	2	250	275
	3	275	300
	4	300	325
	5	325	350
	6	350	375
	7	375	400
	8	400	425
	9	425	450
N	1	450	475
	2	475	500
	3	500	550
	4	550	600
	5	600	650
	6	650	700
	7	700	750
	8	750	800
	9	800	900
P	1	900	1000
	2	1000	1100
	3	1100	1200
	4	1200	1350
	5	1350	1500
	6	1500	1650

White Bin Structure

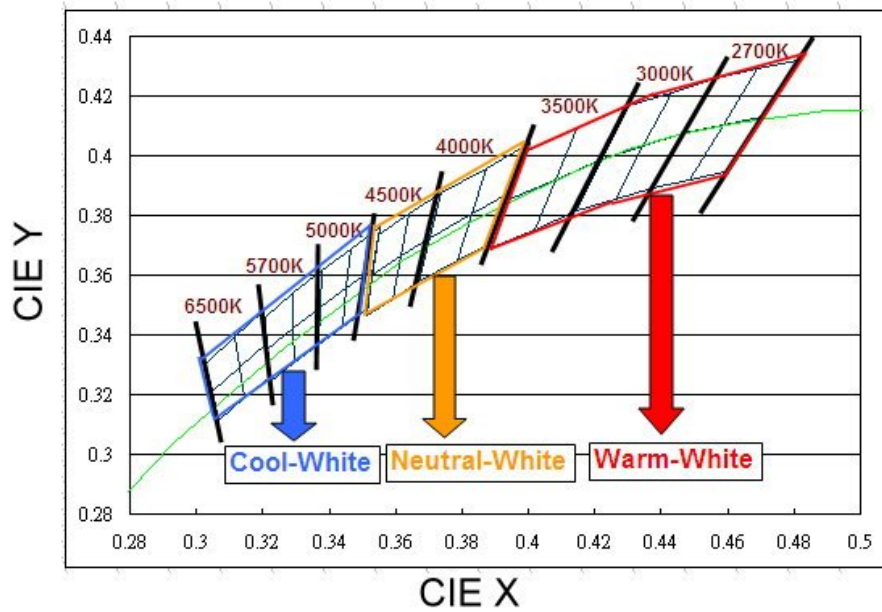

Chromaticity specification defined by ANSI

Notes:

1. The CCT range of Cool-White varies from 4745K to 7050K.
2. The CCT range of Neutral-White varies from 3710K to 4745K.
3. The CCT range of Warm-White varies from 2580K to 3710K
4. Color coordinates measurement allowance : ± 0.01
5. Color bins are defined at $I_f=550\text{mA}$ operation

Warm-White Bin Structure

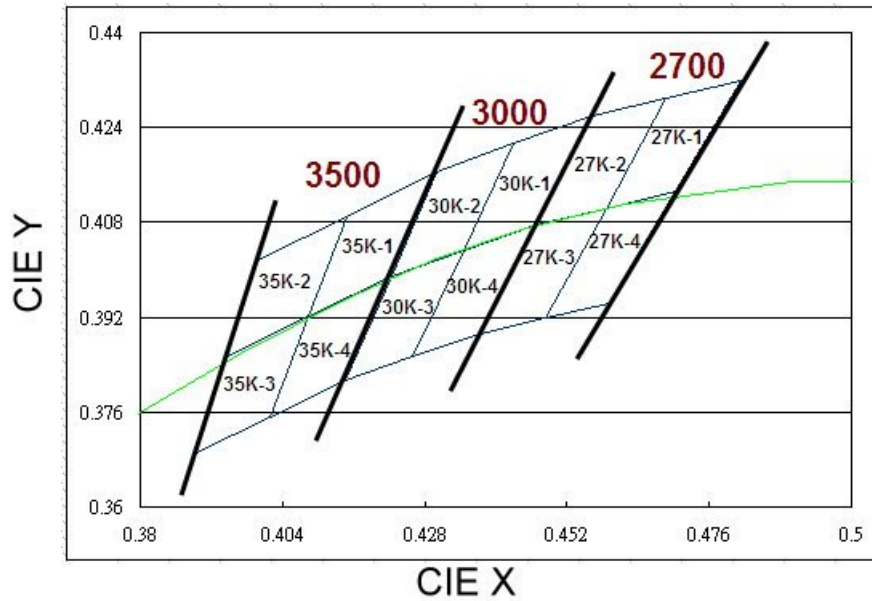

Warm-White Bin Coordinates

2700K

Bin	CIE X	CIE Y
27K-1	0.469	0.429
	0.459	0.410
	0.470	0.413
	0.481	0.432
Reference Range: 2580~2700K		

Bin	CIE X	CIE Y
27K-2	0.456	0.426
	0.447	0.408
	0.459	0.410
	0.469	0.429
Reference Range: 2700~2870K		

Bin	CIE X	CIE Y
27K-4	0.459	0.410
	0.448	0.392
	0.459	0.394
	0.470	0.413
Reference Range: 2580~2700K		

Bin	CIE X	CIE Y
27K-3	0.447	0.408
	0.437	0.389
	0.448	0.392
	0.459	0.410
Reference Range: 2700~2870K		

3000K

Bin	CIE X	CIE Y
30K-1	0.443	0.421
	0.435	0.403
	0.447	0.408
	0.456	0.426
Reference Range: 2870~3000K		

Bin	CIE X	CIE Y
30K-2	0.430	0.417
	0.422	0.399
	0.435	0.403
	0.443	0.421
Reference Range: 3000~3220K		

Bin	CIE X	CIE Y
30K-4	0.435	0.403
	0.426	0.385
	0.437	0.389
	0.447	0.408
Reference Range: 2870~3000K		

Bin	CIE X	CIE Y
30K-3	0.422	0.399
	0.415	0.381
	0.426	0.385
	0.435	0.403
Reference Range: 3000~3220K		

Notes:

- Color coordinates measurement allowance : ±0.01.

Neutral-White Bin Structure

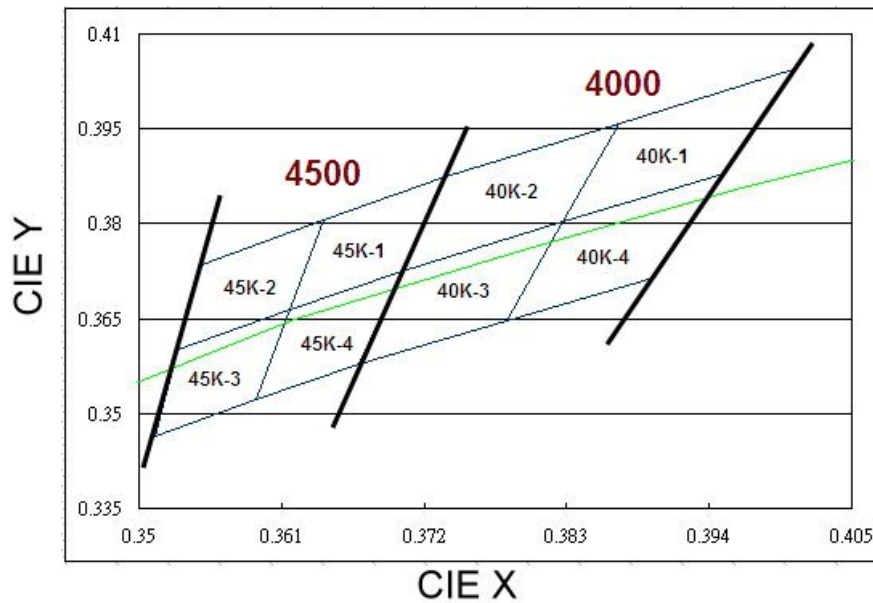

Neutral-White Bin Coordinates

4000K

Bin	CIE X	CIE Y
40K-1	0.387	0.396
	0.383	0.380
	0.395	0.388
	0.401	0.404
Reference Range: 3710~4000K		

Bin	CIE X	CIE Y
40K-2	0.374	0.387
	0.370	0.373
	0.383	0.380
	0.387	0.396
Reference Range: 4000~4260K		

Bin	CIE X	CIE Y
40K-4	0.383	0.380
	0.378	0.365
	0.390	0.372
	0.395	0.388
Reference Range: 3710~4000K		

Bin	CIE X	CIE Y
40K-3	0.370	0.373
	0.367	0.358
	0.378	0.365
	0.383	0.380
Reference Range: 4000~4260K		

Notes:

1. Color coordinates measurement allowance : ± 0.01 .

Cool-White Bin Structure

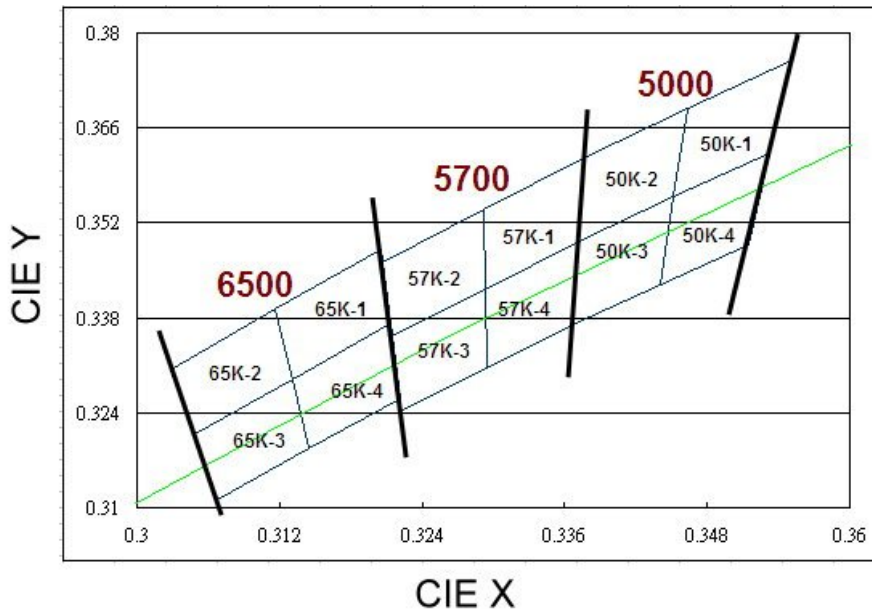

Cool-White Bin Coordinates

5000K

Bin	CIE X	CIE Y
50K-1	0.346	0.369
	0.345	0.356
	0.353	0.362
	0.355	0.376
Reference Range: 4745~5000K		

Bin	CIE X	CIE Y
50K-2	0.338	0.362
	0.337	0.349
	0.345	0.356
	0.346	0.369
Reference Range: 5000~5310K		

Bin	CIE X	CIE Y
50K-4	0.345	0.356
	0.344	0.343
	0.352	0.349
	0.353	0.362
Reference Range: 4745~5000K		

Bin	CIE X	CIE Y
50K-3	0.337	0.349
	0.337	0.337
	0.344	0.343
	0.345	0.356
Reference Range: 5000~5310K		

5700K

Bin	CIE X	CIE Y
57K-1	0.329	0.354
	0.329	0.342
	0.337	0.349
	0.338	0.362
Reference Range: 5310~5700K		

Bin	CIE X	CIE Y
57K-2	0.321	0.346
	0.322	0.335
	0.329	0.342
	0.329	0.354
Reference Range: 5700~6020K		

Bin	CIE X	CIE Y
57K-4	0.329	0.342
	0.329	0.331
	0.337	0.337
	0.337	0.349
Reference Range: 5310~5700K		

Bin	CIE X	CIE Y
57K-3	0.322	0.335
	0.322	0.324
	0.329	0.331
	0.329	0.342
Reference Range: 5700~6020K		

6500K

Bin	CIE X	CIE Y
65K-1	0.312	0.339
	0.313	0.329
	0.321	0.337
	0.321	0.348
Reference Range: 6020~6500K		

Bin	CIE X	CIE Y
65K-2	0.303	0.330
	0.305	0.321
	0.313	0.329
	0.312	0.339
Reference Range: 6500~7050K		

Bin	CIE X	CIE Y
65K-4	0.313	0.329
	0.315	0.319
	0.322	0.326
	0.321	0.337
Reference Range: 6020~6500K		

Bin	CIE X	CIE Y
65K-3	0.305	0.321
	0.307	0.311
	0.315	0.319
	0.313	0.329
Reference Range: 6500~7050K		

Notes:

1. Color coordinates measurement allowance : ± 0.01

EVERLIGHT

Forward Voltage Bins

Bin	Minimum Forward Voltage (V)	Maximum Forward Voltage (V)
R8	16.0	17.0
R9	17.0	18.0
T1	18.0	19.0
T2	19.0	20.0

Notes:

1. Forward voltage measurement tolerance: $\pm 2\%$.
2. Forward voltage bins are defined at $I_f=550\text{mA}$ operation.
3. Other Forward Voltage bins for White LEDs available upon request. Please contact your local Everlight sales office.

EVERLIGHT

Pad Configuration

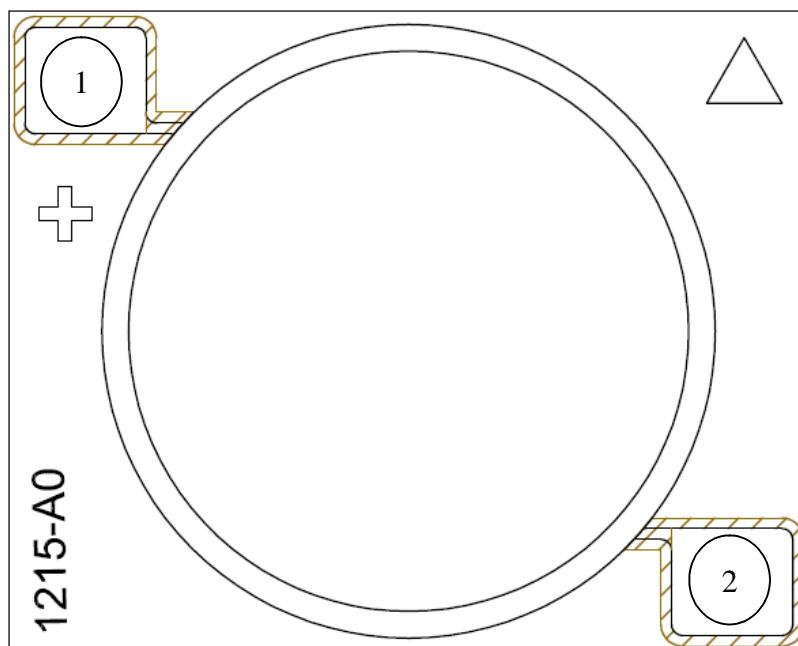

PAD	FUNCTION
1	ANODE
2	CATHODE

Typical Electro-Optical Characteristic Curve

Relative Spectral Distribution
@ Substrate Temperature = 25

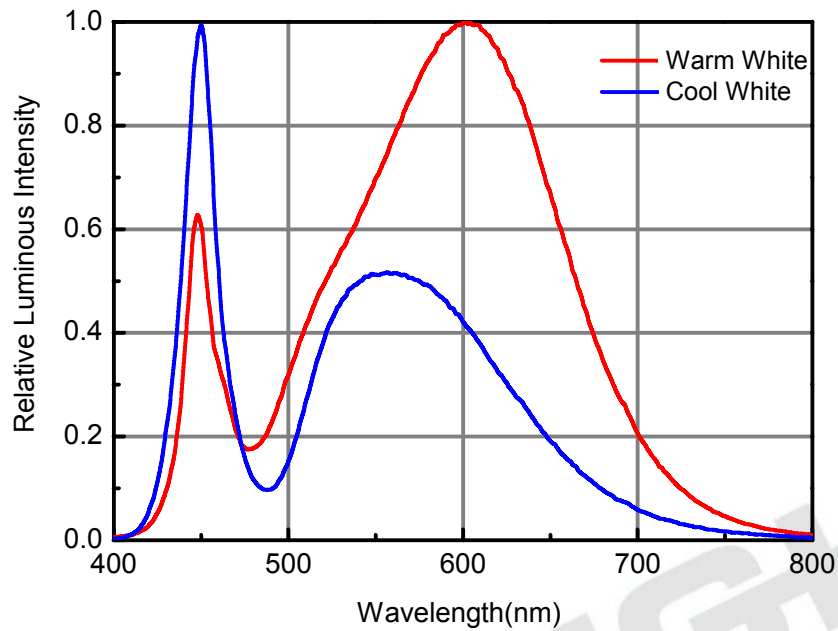

Relative Luminous Flux vs. Substrate Temperature
@ Forward Current = 550mA

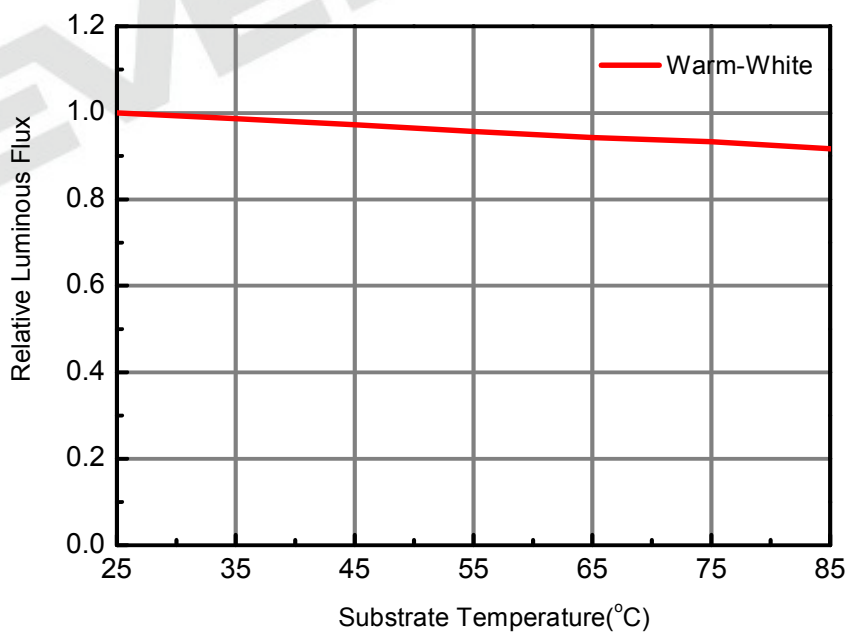

Forward Voltage vs. Forward Current
@ Substrate Temperature = 25

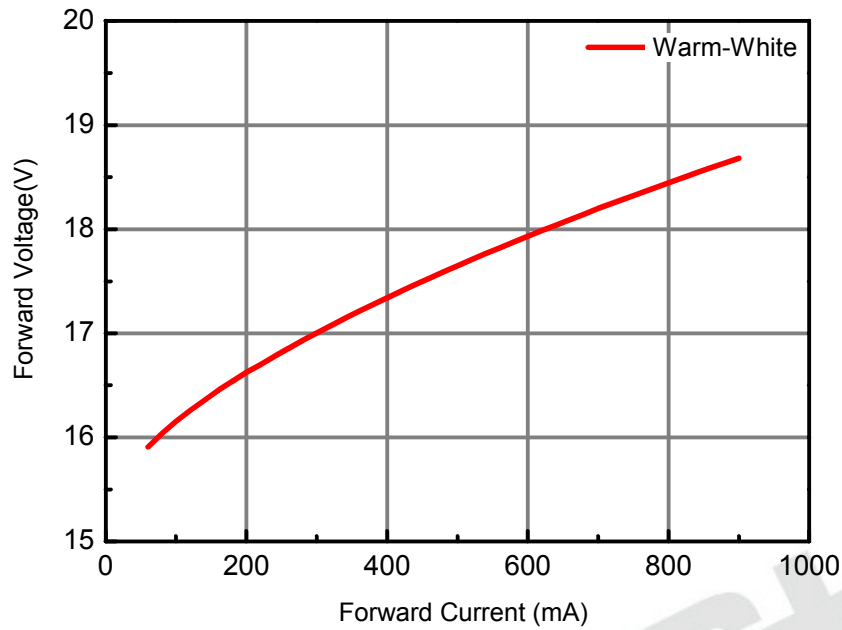

Relative Luminous Flux vs. Forward Current
@ Substrate Temperature = 25

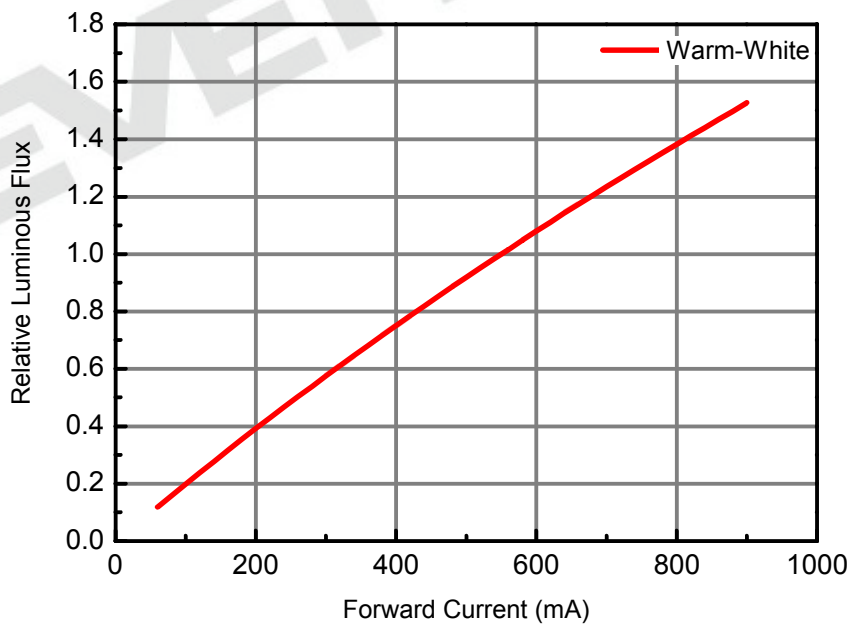

Correlated Color Temperature vs. Forward Current @ Substrate Temperature = 25

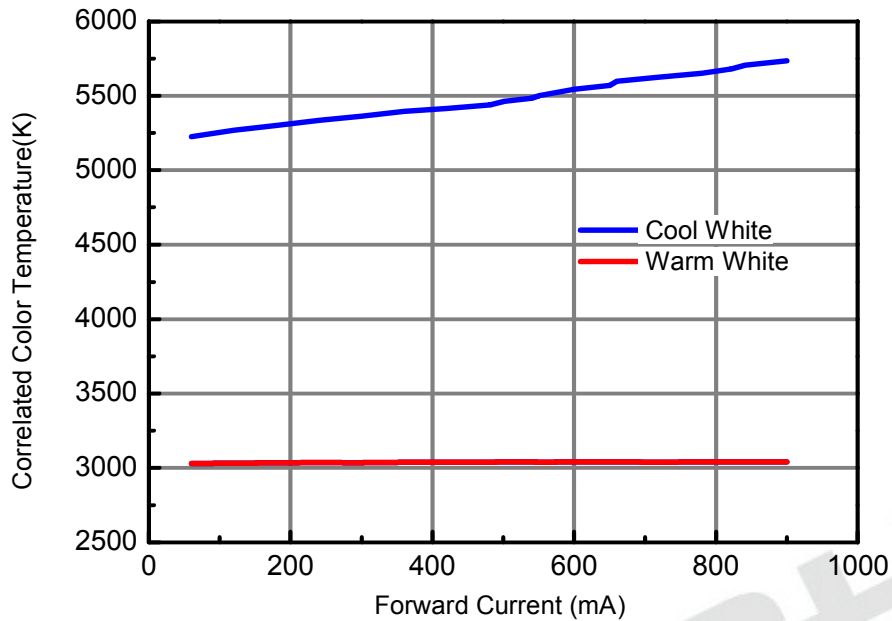

Correlated Color Temperature vs. Substrate Temperature @ Forward Current = 550mA

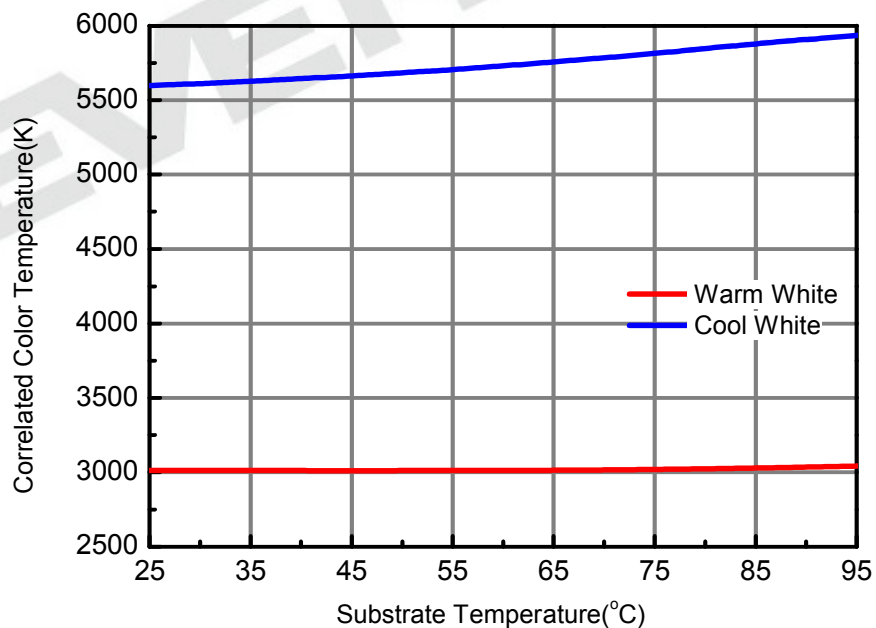

Forward Voltage vs. Substrate Temperature
@ Forward Current = 550mA

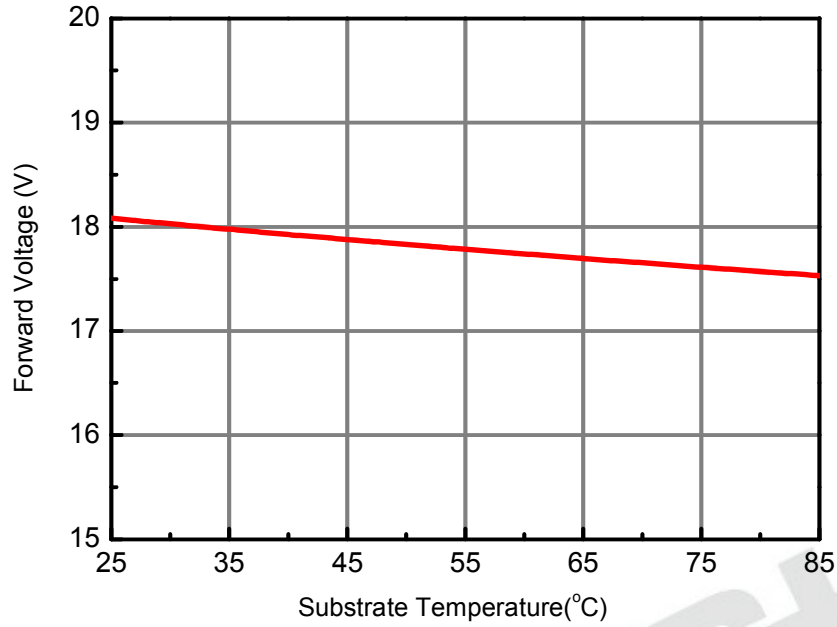

Forward Current Derating Curve
@ Junction Temperature <115

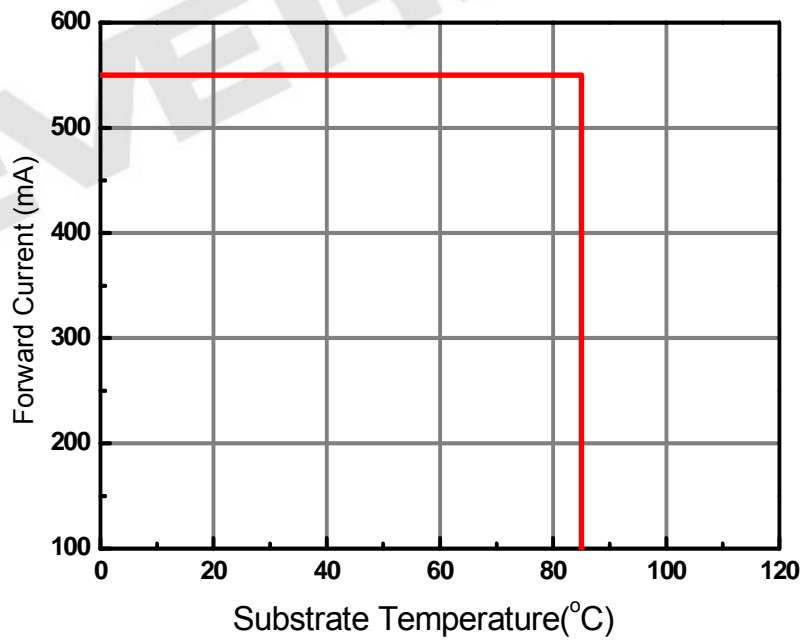

Typical Diagram Characteristics of Radiation Patterns

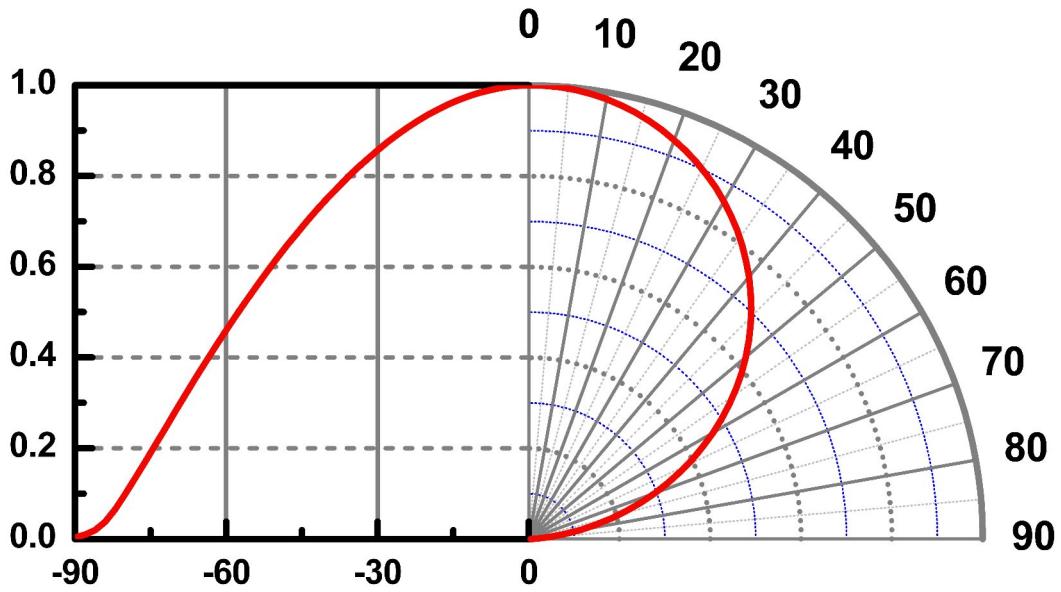

Notes:

1. $2\theta_{1/2}$ is the off axis angle from lamp centerline where the luminous intensity is 1/2 of the peak value.
2. Viewing angle tolerance is $\pm 5^\circ$.

Product Labeling

Label Explanation

CPN: Customer Specification (when required)

P/N : Everlight Production Number

QTY: Packing Quantity

CAT: Luminous Flux (Brightness) Bin

HUE: Color Bin

REF: Forward Voltage Bin

LOT No: Lot Number

MADE IN TAIWAN: Production Place



Carrier Tray Specification

Loaded Quantity: 100 PCS Per Tray

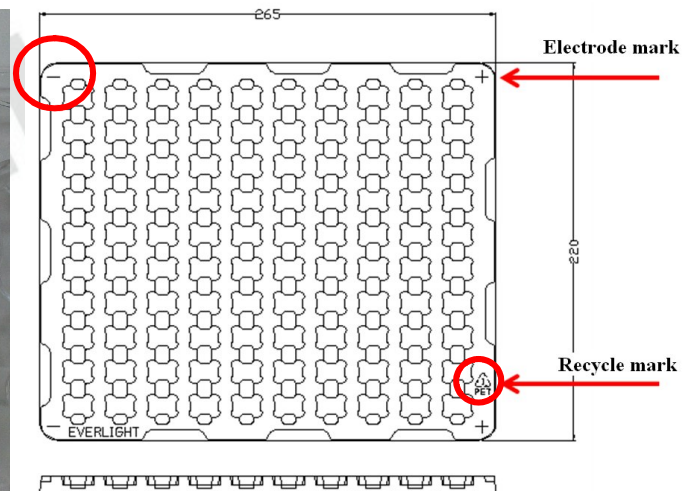

Notes:

1. Dimensions are in millimeters.
2. Tolerances unless mentioned are $\pm 0.1\text{mm}$

LED Direction

- The **Recycle mark** on the LEDs will be toward the **Anode mark** on the carrier tray.

Outside Carton

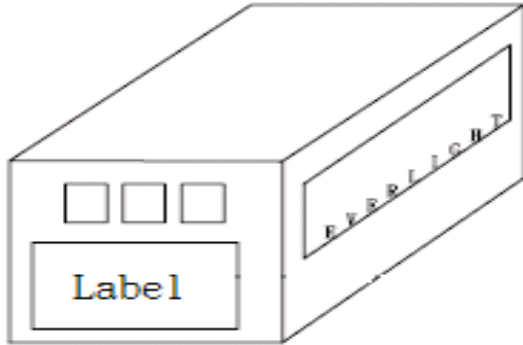

Packaging Quantity

- 100 PCS Per Tray
- 10 Trays Per Outside Carton

EVERLIGHT

Precautions of Use

Over-Current-Proof

- Though the JU1215 has a conducted ESD protection mechanism, customers must not use the device in reverse and should apply resistors for extra protection. Otherwise slight voltage shift may cause significant current changes and burn out failure may happen.

Storage Conditions

- Before the package is opened: The LEDs should be stored at 30°C or less and 50%RH or less after being shipped from Everlight and the storage life limit is 6 months. If the LEDs are stored for 6 months or more, they should be stored in a sealed container with a nitrogen atmosphere and moisture absorbent material.
- After opening the package: The LED should be stored under 30°C or less and 30%RH or less. The LED should be used within 168hrs (7days) after opening the package. If unused LEDs remain, it should be stored in moisture proof packages.
- Do not stack assemblies.

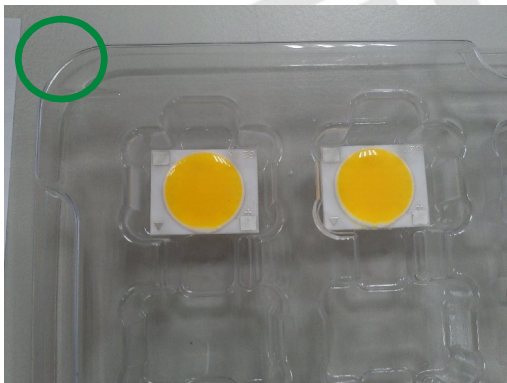

Handling

- Do not put mechanical stress on the LED.
- Never touch the optical surface with finger or sharp object. The LED surface could be soiled or damaged, which could affect the optical performance of the LED.
- In low-humidity work environment, please keep handling the LEDs with appropriate ESD grounding.
- It is recommended to handle the LED with powder-less latex gloves.

Manual Handling

- When handling the product, do not apply direct pressure on the optical surface.
- Do not touch the resin with tweezers to avoid scratching or other damage.

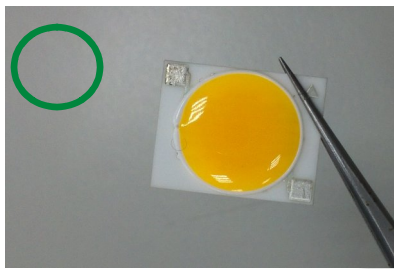

Thermal Management

- Sufficient thermal management must be implemented. Substrate of the positive in temperature must be kept under 105°C at the driving current of 550mA. Otherwise, the junction temperature of die may exceed the limit at high current driving conditions and the LEDs' lifetime may be decrease dramatically.

Revision History

Current version: **2013/02/01**

Previous version: **N/A**

Device No. DHE-0002042

Rev. Ver. 3

Page	Subjects (major change in previous version)	Date of change
	Create new – Warm-White & Neutral-White	2012/12/11
	Create new – Cool-White	2013/02/01

EVERLIGHT