

PASSIVE-DI0° PLASTIC,4XM12,5POL,PRE-WIRED CABLE

15.0m PUR-JB 8*0,34+3*0,75

4-way, 5-pole

PUR/PVC

15.0 m

with LED for digital PNP-signals 24 V DC

Further cable lengths on request.

[Link to Product](#)**Illustration**

M12 Females 5-pole

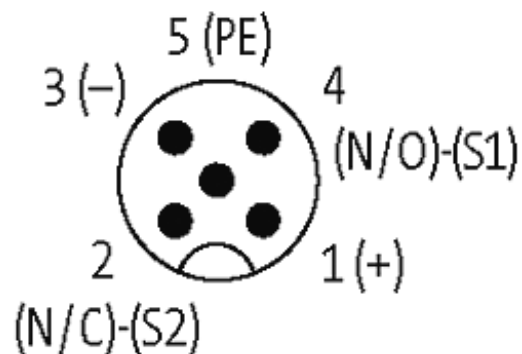

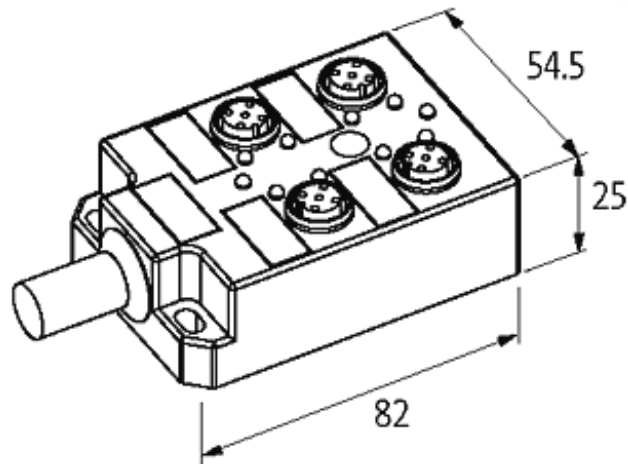

Product may differ from Image

Approvals



Technical Data

Operating voltage	24 V DC
Operating voltage indicator	LED (green)
Signal per port	2
LED display per port	LED (yellow) per signal (PNP)
Operating current per contact	max. 4 A
Total current	max. 8 A
Locking of ports	Screw thread M12 × 1 mm

Cables

No./diameter of wires	8×0.34 + 3×0.75 mm ²
C-track properties	2 Mio.
Material (jacket)	PUR/PVC
Outer diameter	approx. 8.1 mm
Bend radius (moving)	12 × outer Ø
Cable number	363

General data

Dimensions H × W × D	82×54.5×25 mm
Protection	IP67 inserted and tightened (EN 60529)
Temperature range	-20...+80 °C

Contact layout

Contact 1	(+)
Contact 2	(NC)/(S2)
Contact 3	(-)

Contact 4	(NO)/(S1)
-----------	-----------

Contact 5	(Earth)
-----------	---------

Commercial data

country of origin	CZ
-------------------	----

customs tariff number	85444290
-----------------------	----------

minimum order quantity	1
------------------------	---