

MET 1-PHASE SAFETY TRANSFORMER

P: 800VA IN: 230VAC+/- 5% OUT: 24VAC

Single-phase safety transformer
800 VA
Isolation class T 60/B

[Link to Product](#)

Illustration

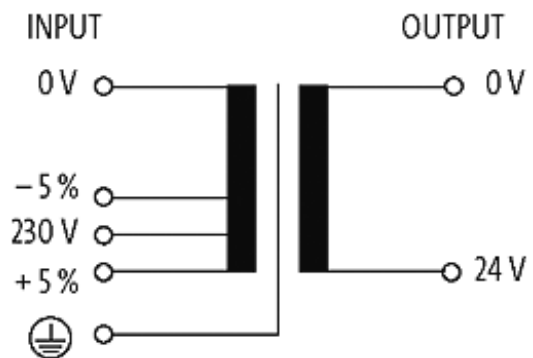

stay connected

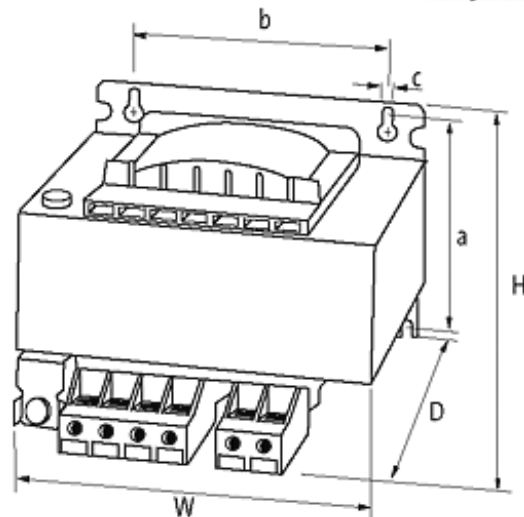

Product may differ from Image

Approvals



Input

Input voltage	230 V AC $\pm 5\%$
Frequency	50...60 Hz
Input current	3.75 A (230 V AC)
Inrush current	92.8 A (230 V AC)
Short-circuit current	87.8 A (230 V AC)

General data

Standards	(EN 61558-1), (EN 61558-2-6), (EN 62041 category 0)
Test isolation voltage	4 kV (prim./sec.)
Mounting method	Key-hole mounting
Temperature range	-20...+60 °C, no condensation
Dimensions H x W x D	117x174x160 mm
Fixing centers a x b x c	92x135x7 mm
Drill hole \emptyset	7x11 mm

Output

Output voltage	24 V AC (SELV)
----------------	----------------

Commercial data

country of origin	CZ
customs tariff number	85043180
minimum order quantity	1