

INSTRUCTION SHEET

Photoelectric Switch with Built-in Power Supply SA1U Series

Universal Voltage · DC Power Types/With or Without Time-delay Outputs

Detection Mode	Universal Voltage Type	DC Power Type
Through-beam	SA1U-T50M (T)	SA1U-T50MW (T)
Polarized Retro-reflective	SA1U-P07M (T)	SA1U-P07MW (T)
Diffuse-reflective	SA1U-D01M (T)	SA1U-D01MW (T)
Background Suppression	SA1U-B02M (T)	SA1U-B02MW (T)

Confirm that the delivered product is what you have ordered.
Read this instruction sheet to make sure of correct operation.
Make sure that the instruction sheet is kept by the end user.

SAFETY PRECAUTIONS

CAUTION

Caution notices are used where inattention might cause personal injury or damage to equipment.

1 Type

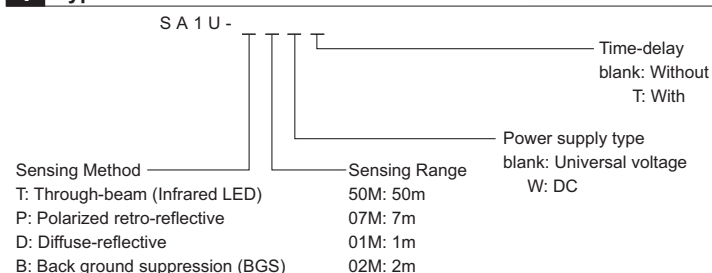

2 Dimensions (mm)

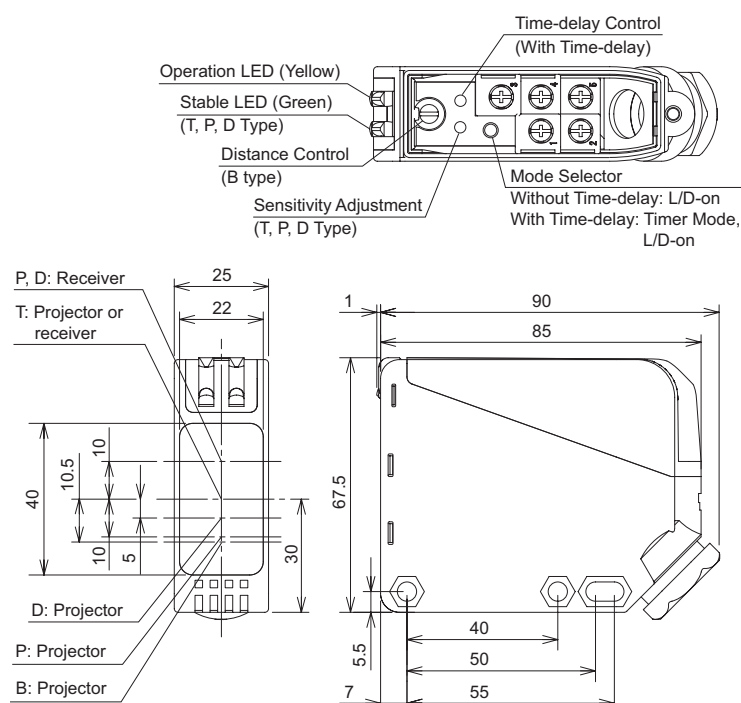

3 Installation

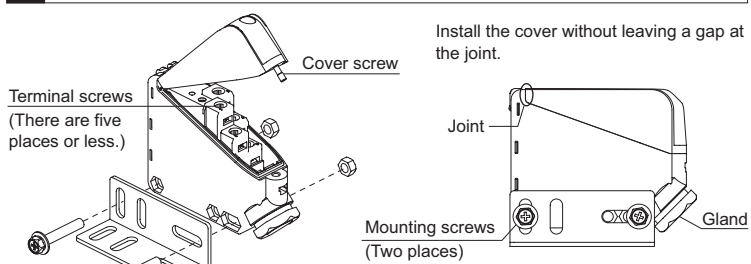

Screw Tightening Torque (N·m)

Screw	Tightening Torque
Terminal	0.6 to 1.0
Gland	4.0 to 6.0
Cover Screw	0.5 to 0.8
Mounting Screw	0.8 to 1.2

4 Specifications

Type No.	Sensing Method		Through-beam	Polarized Retro-reflective	Diffuse-reflective	Background Suppression
	Universal Voltage	Without Time-delay	SA1U-T50M	SA1U-P07M	SA1U-D01M	SA1U-B02M
DC Power	With Time-delay	SA1U-T50MT	SA1U-P07MT	SA1U-D01MT	SA1U-B02MT	
Specifications	Without Time-delay	SA1U-T50MW	SA1U-P07MW	SA1U-D01MW	SA1U-B02MW	
	With Time-delay	SA1U-T50MWT	SA1U-P07MWT	SA1U-D01MWT	SA1U-B02MWT	
Universal Voltage Type	Sensing Range	50m	0.2 to 7m (Using the attached reflector)	1m (200 × 200mm white mat paper)	0.2 to 2m (200 × 200mm white mat paper)	
	Detectable Object	Opaque	Opaque/Specular	Opaque/Specular	Opaque	
	Hysteresis	-	-	20% maximum of operation distance	15% maximum of operation distance	
	Light Source Element	Infrared LED	Infrared LED	Infrared LED	Infrared LED	
	Extraneous Light immunity	Sunlight 10000lx maximum, Incandescent lamp 5000lx maximum				
	Temperature Range	-25 to 60 (no freezing), Storage temperature: -40 to 70 (no freezing)				
	Operating Humidity	35 to 85% RH (storage temperature)				
	Degree of Protection	IP67 (IEC/EN60529) NEMA TYPE 1 (For UL / c-UL)				
	Power Voltage	24 to 240V AC (21.6 to 264V AC) 50/60Hz, 12 to 240V DC (10.8 to 264V DC)				
	Power Consumption	Projector: 3 VA maximum Receiver: 3 VA maximum	3 VA maximum			
DC Power Type	Output	Electromechanical SPDT, Switching capacity: 250V AC · 3A (resistive load), 30V DC · 3A (resistive load)				
	Response Time	20ms maximum				
	Power Voltage	12 to 24V DC, Ripple p-p 10% maximum (10 to 30V DC)				
	Power Consumption	Projector: 20 mA maximum Receiver: 25 mA maximum	30 mA maximum			
	Output	Configuration: NPN and PNP transistor open collector				
DC Power Type	Resistive Load	100 mA maximum				
	Output Voltage	30V DC maximum				
	Voltage Drop	2.4V maximum				
	Response Time	1 ms maximum				

5 Notes for Operation

- Prevent incidence of reflected light from the floor or wall.
- Do not expose the photoelectric switch to sunlight or other direct light projections.
- Do not strike the photoelectric switch with a hammer when installing, otherwise the waterproof characteristics will be impaired. (Except for UL / c-UL)
- For preventing the transient state when turning power on, a circuit to turn output off (universal voltage: 200 ms, DC power: 50 ms) is contained. On the timer-function model, time-delay operation starts when the output is released from the off state. Take care of the operation when turning power on.
- Do not use the photoelectric switch under conditions exceeding the rated operating temperature, vibration resistance, and shock resistance.
- Use the photoelectric switch within the rated power voltage.
- When using a switching power supply, connect the FG (frame ground) terminal to a proper ground.
- When compliance with the EU Low Voltage Directive is required, connect an EN approved fuse outside the power terminals of the universal voltage type.
- Install the cover maintain the water-proof characteristics, install the cover in a regulated position.

CAUTION

Type No. and the wiring diagram, are indicated on the housing and the cover.
When installing the cover, confirm that the cover type agrees with the housing.

6 Wiring Diagram

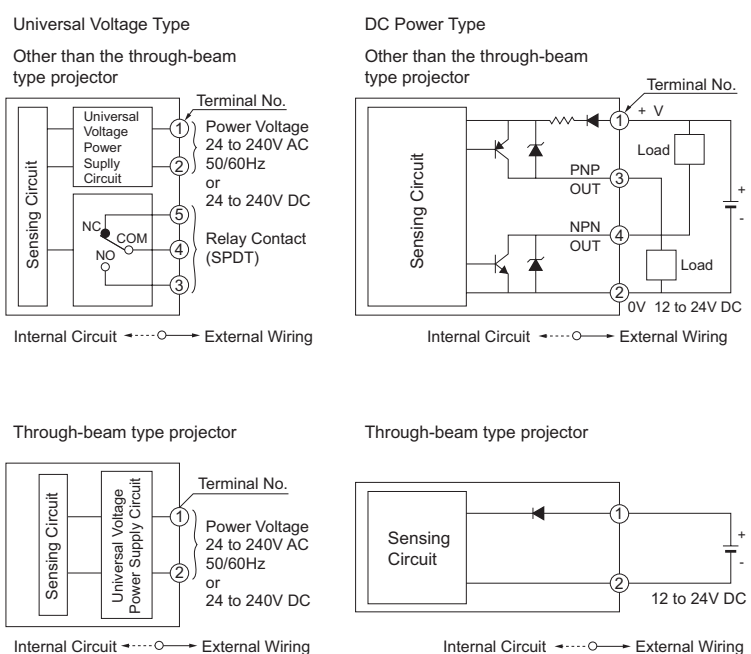

Cable Connection

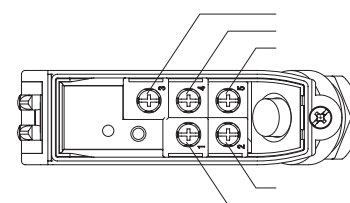
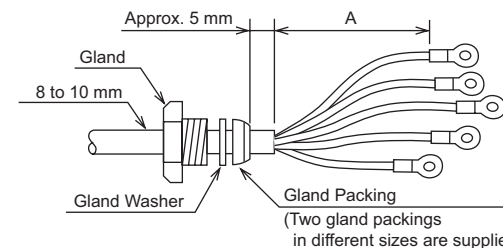

Applicable Lead Extension

Terminal No.	A (mm)
1	45
2	30
3	55
4	40
5	25

- Connect wires starting from the lower terminals. Install the cover using the captive screw.
- Use a cable of 8 to 10 mm in diameter to ensure water- and dust-proof characteristics (Except for UL / c-UL). Two gland packings are supplied; for cables of 8 to 9 mm and 9 to 10 mm in diameter. Use a proper gland packing and a gland washer, and tighten the gland firmly. Keep the cable insulation within 5 mm from the gland packing as shown above. Make sure that the gland washer is placed in the gland packing correctly.
- Turn off the power supply before wiring.
- Connect correctly to prevent damage.
- The power voltage must not exceed the rated range.
- The cable should not be run in the same wire duct with other power supply, motor, or electromagnetic lines because induction noise will cause malfunction or damage to the photoelectric switch.
- Cable extension is allowed up to 100m using a cable with core wires of 0.3 mm² or more. On the DC power supply type, consider the voltage drop by the resistance of the cable.

When connecting crimping terminals, note the direction of the crimping part as shown.

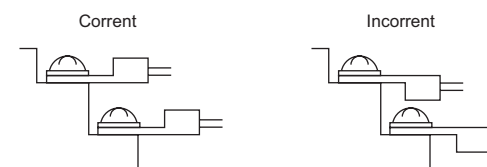

Applicable Crimping Terminal Dimensions

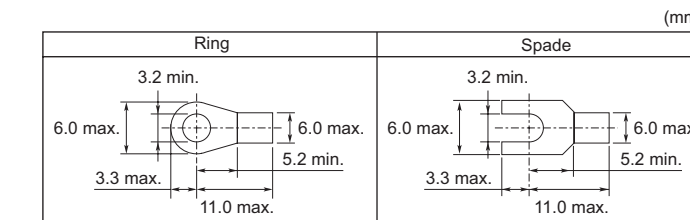

- When using crimping terminals, wrap the terminal with insulating tubes.
- Each screw terminal can accept only one crimping terminal.

7 Optical Axis Alignment & Sensitivity Adjustment

- Through Beam Type**
Direct the projector and the receiver face by eye measure and fasten them tentatively. Direct the receiver upward, downward, and sideways and lock the projector in the middle where the indicator on the receiver goes on.
- Polarized retro-reflective**
Direct the sensor upward, downward, and sideways and lock the reflector in the middle where the indicator goes on or off.
- Diffuse-reflective**
Place the sensing object and direct the sensor upward, downward, and sideways and lock the reflector in the middle where the indicator goes on or off. Without the sensing objects in place, check the indicator goes off. If the background influences, make the sensitivity adjustment as follows.
 - With the sensing object in place, turn the sensitivity adjusting control clockwise from MIN position until the indicator goes on (point A).
 - Remove the object, then the indicator will go off. Turn the sensitivity adjusting control further clockwise until the indicator goes on again by detecting the background (Point B).
 - Set the sensitivity adjusting control at Point C, the middle point between A and B. This point gives the best sensitivity.
NOTE: Use the attached screwdriver to make adjustments. Avoid excessive force to the sensitivity adjusting control to prevent damage.
- Make the sensitivity adjustment of the background suppression (BGS) as follows. (At dark on operation, read lighting the operation indicator in a different way as turning off and adjust it.)
First, direct the sensor and place the object, turn the sensitivity adjusting control counterclockwise until the indicator goes off. Then turn the sensitivity adjusting control clockwise until the indicator goes on (Point A).
Remove the object, then the indicator will go off. Turn the sensitivity adjusting control further clockwise until the indicator goes on again by detecting the background (Point B) (*1).
Set the sensitivity adjusting control at Point C, the middle point between A and B (*2).
*1: Make one turn or more clockwise from point A and set the position as point C when the background is too far and the operation LED does not turn on.
*2: There may be more than 1 turn between points A and B, since this photoelectric switch incorporates a 6-turn adjuster.

8 Operation Chart

