

**Data sheet | Item number: 2002-1402**

4-conductor through terminal block; 2.5 mm<sup>2</sup>; suitable for Ex e II applications; side and center marking; for DIN-rail 35 x 15 and 35 x 7.5; Push-in CAGE CLAMP®

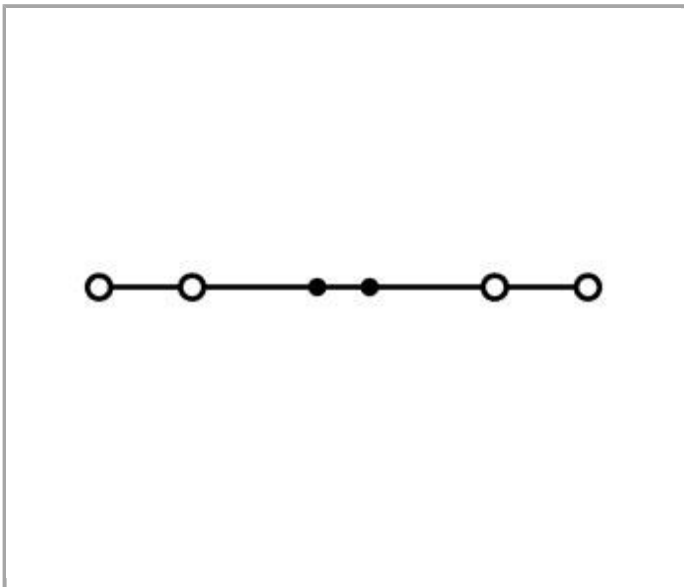

[www.wago.com/2002-1402](http://www.wago.com/2002-1402)

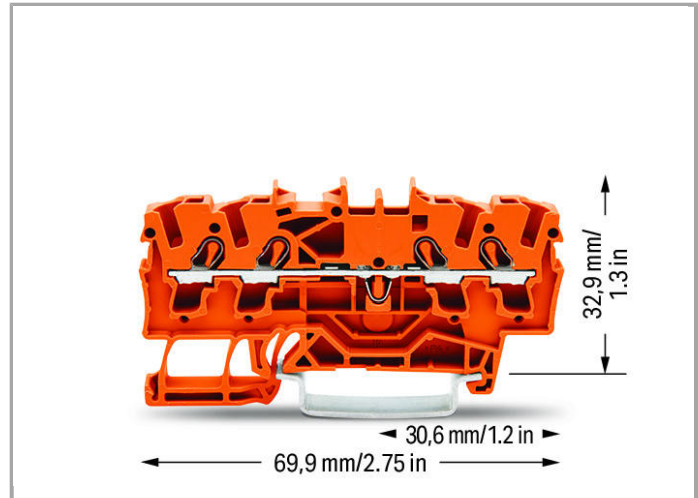
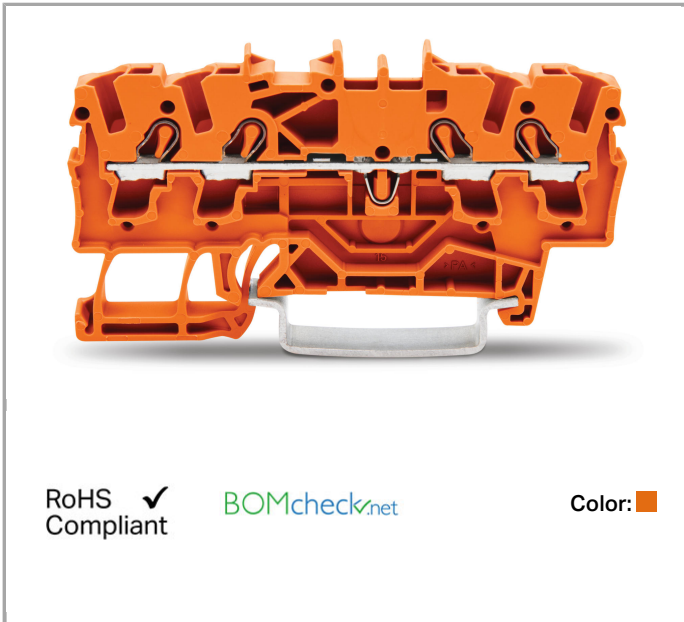

**Data**

**Electrical data**

Rated voltage EN (Ex e II)	550 V
Rated current (Ex e II)	22 A
Rated current (Ex e II) with jumper	20 A



### Ratings per IEC/EN 60664-1

Rated voltage (III / 3)	800 V
Rated impulse voltage (III / 3)	8 kV
Rated current	24 A
Rated current (2)	32 A
Legend (ratings)	(III / 3) $\triangleq$ Overvoltage category III / Pollution degree 3

### Approvals per UL 1059

Rated voltage UL (Use Group B)	600 V
Rated current UL (Use Group B)	20 A
Rated voltage UL (Use Group C)	600 V
Rated current UL (Use Group C)	20 A

### Approvals per CSA

Rated voltage CSA (Use Group B)	600 V
Rated current CSA (Use Group B)	20 A
Rated voltage CSA (Use Group C)	600 V
Rated current CSA (Use Group C)	20 A

### Connection data

Connection technology	Push-in CAGE CLAMP®
Actuation type	Push-in Operating tool
Connectable conductor materials	Copper
Nominal cross section	2.5 mm <sup>2</sup>
Solid conductor	0.25 ... 4 mm <sup>2</sup> / 22 ... 12 AWG
Solid conductor, push-in termination	0.75 ... 4 mm <sup>2</sup> / 18 ... 12 AWG
Fine-stranded conductor	0.25 ... 4 mm <sup>2</sup> / 22 ... 12 AWG
Fine-stranded conductor with ferrule, push-in termination, from	0.75 mm <sup>2</sup> / 18 AWG
Strip length	10 ... 12 mm / 0.39 ... 0.47 Inch
Total number of connection points	4
Total number of potentials	1
Number of levels	1
Type of wiring	Front-entry wiring

### Geometrical Data

Width	5.2 mm / 0.205 inch
Height from upper-edge of DIN-35 rail	32.9 mm / 1.295 inch
Depth	69.9 mm / 2.752 inch

## Mechanical data

Design	horizontal
Type of mounting	DIN-35 rail
Marking level	Center/side marking

## Material Data

Color	orange
Insulating material	Polyamide 66 (PA 66)
Fire load	0.122 MJ
Weight	7.4 g

## Commercial data

Country of origin	DE
GTIN	4017332999298
Customs Tariff No.	85369010000
Product Group	22 (TOPJOB S)

## Approvals / Certificates

### Ex-Approvals

Logo	Approval	Certificate name
	AEx UL International Germany GmbH c/o Physikalisch Technische Bundesanstalt	E185892 sec.7
	AEx UL International Germany GmbH c/o Physikalisch Technische Bundesanstalt	E185892 sec.7
	ATEX Physikalisch Technische Bundesanstalt (PTB)	PTB 03 ATEX 1162 U (II 2 G/D Ex e II bzw. I M 2 Ex e I)
	IECEX Physikalisch Technische Bundesanstalt	IECEX PTB 03.0004U

### Country specific Approvals

Logo	Approval	Certificate name
	CCA DEKRA Certification B.V.	NTR NL 7585
	CSA	1536069



DEKRA Certification B.V.



CSA  
DEKRA Certification B.V.





1536069



KEMA/KEUR  
DEKRA Certification B.V.

2198985.01

### Ship Approvals



Logo	Approval	Certificate name
	<b>ABS</b> American Bureau of Shipping	14-HG1293677-PDA
	<b>BV</b> Bureau Veritas S.A.	38586/A0 BV
	<b>DNV GL</b> Det Norske Veritas, Germanischer Lloyd	TAE00001V2
	<b>LR</b> Lloyds Register	91/20112 (E9)



















### UL-Approvals

















Logo	Approval	Certificate name
	<b>cURus</b> Underwriters Laboratories Inc.	E45172

















### Compatible products

#### Carrier rail

	<b>Item no.: 210-112</b> Steel carrier rail; 35 x 7.5 mm; 1 mm thick; 2 m long; slotted; according to EN 60715; "Hole width 25 mm	<a href="http://www.wago.com/210-112">www.wago.com/210-112</a>
	<b>Item no.: 210-113</b> Steel carrier rail; 35 x 7.5 mm; 1 mm thick; 2 m long; unslotted; according to EN 60715	<a href="http://www.wago.com/210-113">www.wago.com/210-113</a>

	<b>Item no.: 210-114</b> Steel carrier rail; 35 x 15 mm; 1.5 mm thick; 2 m long; unslotted; similar to EN 60715	<a href="http://www.wago.com/210-114">www.wago.com/210-114</a>
	<b>Item no.: 210-115</b> Steel carrier rail; 35 x 7.5 mm; 1 mm thick; 2 m long; slotted; according to EN 60715; "Hole width 18 mm	<a href="http://www.wago.com/210-115">www.wago.com/210-115</a>
	<b>Item no.: 210-118</b> Steel carrier rail; 35 x 15 mm; 2.3 mm thick; 2 m long; unslotted; according to EN 60715	<a href="http://www.wago.com/210-118">www.wago.com/210-118</a>
	<b>Item no.: 210-196</b> Aluminum carrier rail; 35 x 8.2 mm; 1.6 mm thick; 2 m long; unslotted; similar to EN 60715	<a href="http://www.wago.com/210-196">www.wago.com/210-196</a>
	<b>Item no.: 210-197</b> Steel carrier rail; 35 x 15 mm; 1.5 mm thick; 2 m long; slotted; similar to EN 60715	<a href="http://www.wago.com/210-197">www.wago.com/210-197</a>
	<b>Item no.: 210-198</b> Copper carrier rail; 35 x 15 mm; 2.3 mm thick; 2 m long; unslotted; according to EN 60715	<a href="http://www.wago.com/210-198">www.wago.com/210-198</a>
<b>check</b>		
	<b>Item no.: 2002-511</b> Modular TOPJOB®S connector; modular; for jumper contact slot; 1-pole	<a href="http://www.wago.com/2002-511">www.wago.com/2002-511</a>
	<b>Item no.: 2002-549</b> Spacer module; modular; e.g., for bridging commoned terminal blocks	<a href="http://www.wago.com/2002-549">www.wago.com/2002-549</a>
	<b>Item no.: 2002-552</b> TOPJOB®S connector strip; for jumper contact slot; 2-pole	<a href="http://www.wago.com/2002-552">www.wago.com/2002-552</a>
	<b>Item no.: 2002-553</b> TOPJOB®S connector strip; for jumper contact slot; 3-pole	<a href="http://www.wago.com/2002-553">www.wago.com/2002-553</a>
	<b>Item no.: 2002-554</b> TOPJOB®S connector strip; for jumper contact slot; 4-pole	<a href="http://www.wago.com/2002-554">www.wago.com/2002-554</a>
	<b>Item no.: 2002-555</b> TOPJOB®S connector strip; for jumper contact slot; 5-pole	<a href="http://www.wago.com/2002-555">www.wago.com/2002-555</a>
	<b>Item no.: 2002-556</b> TOPJOB®S connector strip; for jumper contact slot; 6-pole	<a href="http://www.wago.com/2002-556">www.wago.com/2002-556</a>
	<b>Item no.: 2002-557</b> TOPJOB®S connector strip; for jumper contact slot; 7-pole	<a href="http://www.wago.com/2002-557">www.wago.com/2002-557</a>
	<b>Item no.: 2002-558</b> TOPJOB®S connector strip; for jumper contact slot; 8-pole	<a href="http://www.wago.com/2002-558">www.wago.com/2002-558</a>
	<b>Item no.: 2002-559</b> TOPJOB®S connector strip; for jumper contact slot; 9-pole	<a href="http://www.wago.com/2002-559">www.wago.com/2002-559</a>
	<b>Item no.: 2002-560</b> TOPJOB®S connector strip; for jumper contact slot; 10-pole	<a href="http://www.wago.com/2002-560">www.wago.com/2002-560</a>
	<b>Item no.: 2002-611</b> TOPJOB®S L-type test plug module; modular; 1-pole	<a href="http://www.wago.com/2002-611">www.wago.com/2002-611</a>
	<b>Item no.: 2002-649</b> TOPJOB®S L-type spacer module; modular; e.g., for bridging commoned terminal blocks	<a href="http://www.wago.com/2002-649">www.wago.com/2002-649</a>

	<b>Item no.: 2009-174</b> Test plug adapter; for 4 mm Ø test plugs; for testing TOPJOB®S rail-mounted terminal blocks	<a href="http://www.wago.com/2009-174">www.wago.com/2009-174</a>
	<b>Item no.: 2009-182</b> Testing tap; for max. 2.5 mm <sup>2</sup> ; tool-free connection for individual test wires 0.08 - 2.5 mm	<a href="http://www.wago.com/2009-182">www.wago.com/2009-182</a>
<b>Marking accessories</b>		
	<b>Item no.: 2002-161</b> Adaptor	<a href="http://www.wago.com/2002-161">www.wago.com/2002-161</a>
	<b>Item no.: 2009-110</b> Marking strips; on reel; not stretchable; plain; snap-on type	<a href="http://www.wago.com/2009-110">www.wago.com/2009-110</a>
	<b>Item no.: 2009-115</b> WMB-Inline; for smartPRINTER; on reel; stretchable 5 - 5.2 mm; plain; snap-on type	<a href="http://www.wago.com/2009-115">www.wago.com/2009-115</a>
	<b>Item no.: 2009-115/000-002</b> WMB-Inline; for smartPRINTER; on reel; stretchable 5 - 5.2 mm; plain; snap-on type	<a href="http://www.wago.com/2009-115/000-002">www.wago.com/2009-115/000-002</a>
	<b>Item no.: 2009-115/000-006</b> WMB-Inline; for smartPRINTER; on reel; stretchable 5 - 5.2 mm; plain; snap-on type	<a href="http://www.wago.com/2009-115/000-006">www.wago.com/2009-115/000-006</a>
	<b>Item no.: 2009-115/000-007</b> WMB-Inline; for smartPRINTER; on reel; stretchable 5 - 5.2 mm; plain; snap-on type	<a href="http://www.wago.com/2009-115/000-007">www.wago.com/2009-115/000-007</a>
	<b>Item no.: 2009-115/000-012</b> WMB-Inline; for smartPRINTER; on reel; stretchable 5 - 5.2 mm; plain; snap-on type	<a href="http://www.wago.com/2009-115/000-012">www.wago.com/2009-115/000-012</a>
	<b>Item no.: 2009-115/000-017</b> WMB-Inline; for smartPRINTER; on reel; stretchable 5 - 5.2 mm; plain; snap-on type	<a href="http://www.wago.com/2009-115/000-017">www.wago.com/2009-115/000-017</a>
	<b>Item no.: 2009-115/000-023</b> WMB-Inline; for smartPRINTER; on reel; stretchable 5 - 5.2 mm; plain; snap-on type	<a href="http://www.wago.com/2009-115/000-023">www.wago.com/2009-115/000-023</a>
	<b>Item no.: 2009-115/000-024</b> WMB-Inline; for smartPRINTER; on reel; stretchable 5 - 5.2 mm; plain; snap-on type	<a href="http://www.wago.com/2009-115/000-024">www.wago.com/2009-115/000-024</a>
	<b>Item no.: 2009-145</b> Mini-WSB Inline; for smartPRINTER; on reel; stretchable 5 - 5.2 mm; plain; snap-on type	<a href="http://www.wago.com/2009-145">www.wago.com/2009-145</a>
	<b>Item no.: 2009-145/000-002</b> Mini-WSB Inline; for smartPRINTER; on reel; stretchable 5 - 5.2 mm; plain; snap-on type	<a href="http://www.wago.com/2009-145/000-002">www.wago.com/2009-145/000-002</a>
	<b>Item no.: 2009-145/000-005</b> Mini-WSB Inline; for smartPRINTER; on reel; stretchable 5 - 5.2 mm; plain; snap-on type	<a href="http://www.wago.com/2009-145/000-005">www.wago.com/2009-145/000-005</a>
	<b>Item no.: 2009-145/000-006</b> Mini-WSB Inline; for smartPRINTER; on reel; stretchable 5 - 5.2 mm; plain; snap-on type	<a href="http://www.wago.com/2009-145/000-006">www.wago.com/2009-145/000-006</a>

	<b>Item no.: 2009-145/000-007</b> Mini-WSB Inline; for smartPRINTER; on reel; stretchable 5 - 5.2 mm; plain; snap-on type	<a href="http://www.wago.com/2009-145/000-007">www.wago.com/2009-145/000-007</a>
	<b>Item no.: 2009-145/000-012</b> Mini-WSB Inline; for smartPRINTER; on reel; stretchable 5 - 5.2 mm; plain; snap-on type	<a href="http://www.wago.com/2009-145/000-012">www.wago.com/2009-145/000-012</a>
	<b>Item no.: 2009-145/000-023</b> Mini-WSB Inline; for smartPRINTER; on reel; stretchable 5 - 5.2 mm; plain; snap-on type	<a href="http://www.wago.com/2009-145/000-023">www.wago.com/2009-145/000-023</a>
	<b>Item no.: 2009-145/000-024</b> Mini-WSB Inline; on reel; stretchable 5 - 5.2 mm; plain; snap-on type	<a href="http://www.wago.com/2009-145/000-024">www.wago.com/2009-145/000-024</a>
	<b>Item no.: 2009-191</b> Group marker carrier	<a href="http://www.wago.com/2009-191">www.wago.com/2009-191</a>
	<b>Item no.: 2009-192</b> Group marker carrier	<a href="http://www.wago.com/2009-192">www.wago.com/2009-192</a>
	<b>Item no.: 2009-193</b> Group marker carrier	<a href="http://www.wago.com/2009-193">www.wago.com/2009-193</a>
	<b>Item no.: 2009-198</b> Adaptor	<a href="http://www.wago.com/2009-198">www.wago.com/2009-198</a>
	<b>Item no.: 248-501</b> Miniature WSB Quick marking system; plain; Marker width 5 mm; 10 strips with 10 markers per card	<a href="http://www.wago.com/248-501">www.wago.com/248-501</a>
	<b>Item no.: 248-501/000-002</b> Mini-WSB marking card; as card; not stretchable; plain; snap-on type	<a href="http://www.wago.com/248-501/000-002">www.wago.com/248-501/000-002</a>
	<b>Item no.: 248-501/000-005</b> Mini-WSB marking card; as card; plain; snap-on type	<a href="http://www.wago.com/248-501/000-005">www.wago.com/248-501/000-005</a>
	<b>Item no.: 248-501/000-006</b> Mini-WSB marking card; as card; not stretchable; plain; snap-on type	<a href="http://www.wago.com/248-501/000-006">www.wago.com/248-501/000-006</a>
	<b>Item no.: 248-501/000-007</b> Mini-WSB marking card; as card; not stretchable; plain; snap-on type	<a href="http://www.wago.com/248-501/000-007">www.wago.com/248-501/000-007</a>
	<b>Item no.: 248-501/000-012</b> Mini-WSB marking card; as card; not stretchable; plain; snap-on type	<a href="http://www.wago.com/248-501/000-012">www.wago.com/248-501/000-012</a>
	<b>Item no.: 248-501/000-017</b> Mini-WSB marking card; as card; not stretchable; plain; snap-on type	<a href="http://www.wago.com/248-501/000-017">www.wago.com/248-501/000-017</a>
	<b>Item no.: 248-501/000-023</b> Mini-WSB marking card; as card; not stretchable; plain; snap-on type	<a href="http://www.wago.com/248-501/000-023">www.wago.com/248-501/000-023</a>



**Item no.: 248-501/000-024**  
Mini-WSB marking card; as card; not stretchable; plain; snap-on type

[www.wago.com/248-501/000-024](http://www.wago.com/248-501/000-024)



**Item no.: 793-501**  
WMB marking card; as card; not stretchable; plain; snap-on type

[www.wago.com/793-501](http://www.wago.com/793-501)



**Item no.: 793-501/000-002**  
WMB marking card; as card; not stretchable; plain; snap-on type

[www.wago.com/793-501/000-002](http://www.wago.com/793-501/000-002)



**Item no.: 793-501/000-005**  
WMB marking card; as card; not stretchable; plain; snap-on type

[www.wago.com/793-501/000-005](http://www.wago.com/793-501/000-005)



**Item no.: 793-501/000-006**  
WMB marking card; as card; not stretchable; plain; snap-on type

[www.wago.com/793-501/000-006](http://www.wago.com/793-501/000-006)



**Item no.: 793-501/000-007**  
WMB marking card; as card; not stretchable; plain; snap-on type

[www.wago.com/793-501/000-007](http://www.wago.com/793-501/000-007)



**Item no.: 793-501/000-012**  
WMB marking card; as card; not stretchable; plain; snap-on type

[www.wago.com/793-501/000-012](http://www.wago.com/793-501/000-012)



**Item no.: 793-501/000-017**  
WMB marking card; as card; not stretchable; plain; snap-on type

[www.wago.com/793-501/000-017](http://www.wago.com/793-501/000-017)



**Item no.: 793-501/000-023**  
WMB marking card; as card; not stretchable; plain; snap-on type

[www.wago.com/793-501/000-023](http://www.wago.com/793-501/000-023)



**Item no.: 793-501/000-024**  
WMB marking card; as card; not stretchable; plain; snap-on type

[www.wago.com/793-501/000-024](http://www.wago.com/793-501/000-024)



**Item no.: 793-5501**  
WMB marking card; as card; for terminal block width 5 - 17.5 mm; stretchable 5 - 5.2 mm; plain; snap-on type

[www.wago.com/793-5501](http://www.wago.com/793-5501)



**Item no.: 793-5501/000-002**  
WMB marking card; as card; for terminal block width 5 - 17.5 mm; stretchable 5 - 5.2 mm; plain; snap-on type

[www.wago.com/793-5501/000-002](http://www.wago.com/793-5501/000-002)



**Item no.: 793-5501/000-005**  
WMB marking card; as card; stretchable 5 - 5.2 mm; plain; snap-on type

[www.wago.com/793-5501/000-005](http://www.wago.com/793-5501/000-005)



**Item no.: 793-5501/000-006**  
WMB marking card; as card; stretchable 5 - 5.2 mm; plain; snap-on type

[www.wago.com/793-5501/000-006](http://www.wago.com/793-5501/000-006)



**Item no.: 793-5501/000-007**  
WMB marking card; as card; stretchable 5 - 5.2 mm; plain; snap-on type

[www.wago.com/793-5501/000-007](http://www.wago.com/793-5501/000-007)





**Item no.: 793-5501/000-012**  
WMB marking card; as card; stretchable 5 - 5.2 mm; plain; snap-on type

[www.wago.com/793-5501/000-012](http://www.wago.com/793-5501/000-012)



**Item no.: 793-5501/000-017**  
WMB marking card; as card; stretchable 5 - 5.2 mm; plain; snap-on type

[www.wago.com/793-5501/000-017](http://www.wago.com/793-5501/000-017)



**Item no.: 793-5501/000-023**  
WMB marking card; as card; stretchable 5 - 5.2 mm; plain; snap-on type

[www.wago.com/793-5501/000-023](http://www.wago.com/793-5501/000-023)



**Item no.: 793-5501/000-024**  
WMB marking card; as card; stretchable 5 - 5.2 mm; plain; snap-on type

[www.wago.com/793-5501/000-024](http://www.wago.com/793-5501/000-024)

## Jumper



**Item no.: 2002-400**  
Adjacent jumper for continuous commoning; insulated; 2-way; Nominal current 25 A

[www.wago.com/2002-400](http://www.wago.com/2002-400)



**Item no.: 2002-402**  
Push-in type jumper bar; insulated; 2-way; Nominal current 25 A

[www.wago.com/2002-402](http://www.wago.com/2002-402)



**Item no.: 2002-402/000-005**  
Push-in type jumper bar; insulated; 2-way; Nominal current 25 A

[www.wago.com/2002-402/000-005](http://www.wago.com/2002-402/000-005)



**Item no.: 2002-402/000-006**  
Push-in type jumper bar; insulated; 2-way; Nominal current 25 A

[www.wago.com/2002-402/000-006](http://www.wago.com/2002-402/000-006)



**Item no.: 2002-403**  
Push-in type jumper bar; insulated; 3-way; Nominal current 25 A

[www.wago.com/2002-403](http://www.wago.com/2002-403)



**Item no.: 2002-403/000-005**  
Push-in type jumper bar; insulated; 3-way; Nominal current 25 A

[www.wago.com/2002-403/000-005](http://www.wago.com/2002-403/000-005)



**Item no.: 2002-403/000-006**  
Push-in type jumper bar; insulated; 3-way; Nominal current 25 A

[www.wago.com/2002-403/000-006](http://www.wago.com/2002-403/000-006)



**Item no.: 2002-404**  
Push-in type jumper bar; insulated; 4-way; Nominal current 25 A

[www.wago.com/2002-404](http://www.wago.com/2002-404)



**Item no.: 2002-404/000-005**  
Push-in type jumper bar; insulated; 4-way; Nominal current 25 A

[www.wago.com/2002-404/000-005](http://www.wago.com/2002-404/000-005)



















**Item no.: 2002-404/000-006**  
Push-in type jumper bar; insulated; 4-way; Nominal current 25 A

















[www.wago.com/2002-404/000-006](http://www.wago.com/2002-404/000-006)



















**Item no.: 2002-405**  
Push-in type jumper bar; insulated; 5-way; Nominal current 25 A

[www.wago.com/2002-405](http://www.wago.com/2002-405)

	<b>Item no.: 2002-405/000-005</b> Push-in type jumper bar; insulated; 5-way; Nominal current 25 A	<a href="http://www.wago.com/2002-405/000-005">www.wago.com/2002-405/000-005</a>
	<b>Item no.: 2002-405/000-006</b> Push-in type jumper bar; insulated; 5-way; Nominal current 25 A	<a href="http://www.wago.com/2002-405/000-006">www.wago.com/2002-405/000-006</a>
	<b>Item no.: 2002-405/011-000</b> Star point jumper; insulated; 3-way (1-3-5); IN = IN terminal block	<a href="http://www.wago.com/2002-405/011-000">www.wago.com/2002-405/011-000</a>
	<b>Item no.: 2002-406</b> Push-in type jumper bar; insulated; 6-way; Nominal current 25 A	<a href="http://www.wago.com/2002-406">www.wago.com/2002-406</a>
	<b>Item no.: 2002-406/000-005</b> Push-in type jumper bar; insulated; 6-way; Nominal current 25 A	<a href="http://www.wago.com/2002-406/000-005">www.wago.com/2002-406/000-005</a>
	<b>Item no.: 2002-406/000-006</b> Push-in type jumper bar; insulated; 6-way; Nominal current 25 A	<a href="http://www.wago.com/2002-406/000-006">www.wago.com/2002-406/000-006</a>
	<b>Item no.: 2002-406/020-000</b> Delta jumper; insulated; 1-2 3-4 5-6; IN = IN terminal block	<a href="http://www.wago.com/2002-406/020-000">www.wago.com/2002-406/020-000</a>
	<b>Item no.: 2002-407</b> Push-in type jumper bar; insulated; 7-way; Nominal current 25 A	<a href="http://www.wago.com/2002-407">www.wago.com/2002-407</a>
	<b>Item no.: 2002-407/000-005</b> Push-in type jumper bar; insulated; 7-way; Nominal current 25 A	<a href="http://www.wago.com/2002-407/000-005">www.wago.com/2002-407/000-005</a>
	<b>Item no.: 2002-407/000-006</b> Push-in type jumper bar; insulated; 7-way; Nominal current 25 A	<a href="http://www.wago.com/2002-407/000-006">www.wago.com/2002-407/000-006</a>
	<b>Item no.: 2002-408</b> Push-in type jumper bar; insulated; 8-way; Nominal current 25 A	<a href="http://www.wago.com/2002-408">www.wago.com/2002-408</a>
	<b>Item no.: 2002-408/000-005</b> Push-in type jumper bar; insulated; 8-way; Nominal current 25 A	<a href="http://www.wago.com/2002-408/000-005">www.wago.com/2002-408/000-005</a>
	<b>Item no.: 2002-408/000-006</b> Push-in type jumper bar; insulated; 8-way; Nominal current 25 A	<a href="http://www.wago.com/2002-408/000-006">www.wago.com/2002-408/000-006</a>
	<b>Item no.: 2002-409</b> Push-in type jumper bar; insulated; 9-way; Nominal current 25 A	<a href="http://www.wago.com/2002-409">www.wago.com/2002-409</a>
	<b>Item no.: 2002-409/000-005</b> Push-in type jumper bar; insulated; 9-way; Nominal current 25 A	<a href="http://www.wago.com/2002-409/000-005">www.wago.com/2002-409/000-005</a>
	<b>Item no.: 2002-409/000-006</b> Push-in type jumper bar; insulated; 9-way; Nominal current 25 A	<a href="http://www.wago.com/2002-409/000-006">www.wago.com/2002-409/000-006</a>

	<b>Item no.: 2002-410</b> Push-in type jumper bar; insulated; 10-way; Nominal current 25 A	<a href="http://www.wago.com/2002-410">www.wago.com/2002-410</a>
	<b>Item no.: 2002-410/000-005</b> Push-in type jumper bar; insulated; 10-way; Nominal current 25 A	<a href="http://www.wago.com/2002-410/000-005">www.wago.com/2002-410/000-005</a>
	<b>Item no.: 2002-410/000-006</b> Push-in type jumper bar; insulated; 10-way; Nominal current 25 A	<a href="http://www.wago.com/2002-410/000-006">www.wago.com/2002-410/000-006</a>
	<b>Item no.: 2002-423</b> Push-in type jumper bar; insulated; from 1 to 3; Nominal current 25 A	<a href="http://www.wago.com/2002-423">www.wago.com/2002-423</a>
	<b>Item no.: 2002-423/000-005</b> Adjacent jumper for continuous commoning; insulated; from 1 to 3; Nominal current 25 A	<a href="http://www.wago.com/2002-423/000-005">www.wago.com/2002-423/000-005</a>
	<b>Item no.: 2002-423/000-006</b> Adjacent jumper for continuous commoning; insulated; from 1 to 3; Nominal current 25 A	<a href="http://www.wago.com/2002-423/000-006">www.wago.com/2002-423/000-006</a>
	<b>Item no.: 2002-433</b> Push-in type jumper bar; insulated; from 1 to 3; Nominal current 25 A	<a href="http://www.wago.com/2002-433">www.wago.com/2002-433</a>
	<b>Item no.: 2002-434</b> Push-in type jumper bar; insulated; from 1 to 4; Nominal current 25 A	<a href="http://www.wago.com/2002-434">www.wago.com/2002-434</a>
	<b>Item no.: 2002-435</b> Push-in type jumper bar; insulated; from 1 to 5; Nominal current 25 A	<a href="http://www.wago.com/2002-435">www.wago.com/2002-435</a>
	<b>Item no.: 2002-436</b> Push-in type jumper bar; insulated; from 1 to 6; Nominal current 25 A	<a href="http://www.wago.com/2002-436">www.wago.com/2002-436</a>
	<b>Item no.: 2002-437</b> Push-in type jumper bar; insulated; from 1 to 7; Nominal current 25 A	<a href="http://www.wago.com/2002-437">www.wago.com/2002-437</a>
	<b>Item no.: 2002-438</b> Push-in type jumper bar; insulated; from 1 to 8; Nominal current 25 A	<a href="http://www.wago.com/2002-438">www.wago.com/2002-438</a>
	<b>Item no.: 2002-439</b> Push-in type jumper bar; insulated; from 1 to 9; Nominal current 25 A	<a href="http://www.wago.com/2002-439">www.wago.com/2002-439</a>
	<b>Item no.: 2002-440</b> Push-in type jumper bar; insulated; from 1 to 10; Nominal current 25 A	<a href="http://www.wago.com/2002-440">www.wago.com/2002-440</a>
	<b>Item no.: 2002-472</b> Staggered jumper; insulated; 2-way; Nominal current 25 A; suitable for 2002 and 2003 Series rail-mounted terminal blocks	<a href="http://www.wago.com/2002-472">www.wago.com/2002-472</a>
	<b>Item no.: 2002-473</b> Staggered jumper; insulated; 3-way; Nominal current 25 A; suitable for 2002 and 2003 Series rail-mounted terminal blocks	<a href="http://www.wago.com/2002-473">www.wago.com/2002-473</a>
	<b>Item no.: 2002-473/011-000</b> Ready-made staggered jumper; insulated; 2-way (1-3); Nominal current 25 A; with contact lugs broken off at the factory and circuit marking	<a href="http://www.wago.com/2002-473/011-000">www.wago.com/2002-473/011-000</a>
	<b>Item no.: 2002-474</b>	

	Staggered jumper; insulated; 4-way; Nominal current 25 A; suitable for 2002 and 2003 Series rail-mounted terminal blocks	<a href="http://www.wago.com/2002-474">www.wago.com/2002-474</a>
	<b>Item no.: 2002-475</b> Staggered jumper; insulated; 5-way; Nominal current 25 A; suitable for 2002 and 2003 Series rail-mounted terminal blocks	<a href="http://www.wago.com/2002-475">www.wago.com/2002-475</a>
	<b>Item no.: 2002-475/011-000</b> Ready-made staggered jumper; insulated; 3-way (1-3-5); Nominal current 25 A; with contact lugs broken off at the factory and circuit marking	<a href="http://www.wago.com/2002-475/011-000">www.wago.com/2002-475/011-000</a>
	<b>Item no.: 2002-476</b> Staggered jumper; insulated; 6-way; Nominal current 25 A; suitable for 2002 and 2003 Series rail-mounted terminal blocks	<a href="http://www.wago.com/2002-476">www.wago.com/2002-476</a>
	<b>Item no.: 2002-477</b> Staggered jumper; insulated; 7-way; Nominal current 25 A; suitable for 2002 and 2003 Series rail-mounted terminal blocks	<a href="http://www.wago.com/2002-477">www.wago.com/2002-477</a>
	<b>Item no.: 2002-477/011-000</b> Ready-made staggered jumper; insulated; 1-3-5-7; Nominal current 25 A; with contact lugs broken off at the factory and circuit marking	<a href="http://www.wago.com/2002-477/011-000">www.wago.com/2002-477/011-000</a>
	<b>Item no.: 2002-478</b> Staggered jumper; insulated; 8-way; Nominal current 25 A; suitable for 2002 and 2003 Series rail-mounted terminal blocks	<a href="http://www.wago.com/2002-478">www.wago.com/2002-478</a>
	<b>Item no.: 2002-479</b> Staggered jumper; insulated; 9-way; Nominal current 25 A; suitable for 2002 and 2003 Series rail-mounted terminal blocks	<a href="http://www.wago.com/2002-479">www.wago.com/2002-479</a>
	<b>Item no.: 2002-479/011-000</b> Ready-made staggered jumper; insulated; 1-3-5-7-9; Nominal current 25 A; with contact lugs broken off at the factory and circuit marking	<a href="http://www.wago.com/2002-479/011-000">www.wago.com/2002-479/011-000</a>
	<b>Item no.: 2002-480</b> Staggered jumper; insulated; 10-way; Nominal current 25 A; suitable for 2002 and 2003 Series rail-mounted terminal blocks	<a href="http://www.wago.com/2002-480">www.wago.com/2002-480</a>
	<b>Item no.: 2002-481</b> Staggered jumper; insulated; 11-way; Nominal current 25 A; suitable for 2002 and 2003 Series rail-mounted terminal blocks	<a href="http://www.wago.com/2002-481">www.wago.com/2002-481</a>
	<b>Item no.: 2002-481/011-000</b> Ready-made staggered jumper; insulated; 1-3-5-7-9-11; Nominal current 25 A; with contact lugs broken off at the factory and circuit marking	<a href="http://www.wago.com/2002-481/011-000">www.wago.com/2002-481/011-000</a>
	<b>Item no.: 2002-482</b> Staggered jumper; insulated; 12-way; Nominal current 25 A; suitable for 2002 and 2003 Series rail-mounted terminal blocks	<a href="http://www.wago.com/2002-482">www.wago.com/2002-482</a>
	<b>Item no.: 2006-499</b> Step-down jumper; insulated; from 6/4 mm <sup>2</sup> to 4/2.5/1.5 mm <sup>2</sup> ; Nominal current 32 A	<a href="http://www.wago.com/2006-499">www.wago.com/2006-499</a>
	<b>Item no.: 2009-412</b> Push-in type wire jumper; insulated; wire length 60 mm; Conductor cross section 1.5 mm <sup>2</sup> ; suitable for 2001, 2002, 2003 and 2022 Series rail-mounted terminal blocks	<a href="http://www.wago.com/2009-412">www.wago.com/2009-412</a>
	<b>Item no.: 2009-414</b> Push-in type wire jumper; insulated; wire length 110 mm; Conductor cross section 1.5 mm <sup>2</sup> ; suitable for 2001, 2002, 2003 and 2022 Series rail-mounted terminal blocks	<a href="http://www.wago.com/2009-414">www.wago.com/2009-414</a>
	<b>Item no.: 2009-416</b> Push-in type wire jumper; insulated; wire length 250 mm; Conductor cross section 1.5 mm <sup>2</sup> ; suitable for 2001, 2002, 2003 and 2022 Series rail-mounted terminal blocks	<a href="http://www.wago.com/2009-416">www.wago.com/2009-416</a>



**Item no.: 2016-499**  
Step-down jumper; insulated; from 16/10 mm<sup>2</sup> to 10/6/4/2.5 mm<sup>2</sup>; Nominal current 57 A

[www.wago.com/2016-499](http://www.wago.com/2016-499)



**Item no.: 210-103**  
Wire commoning chain; insulated; 50 connections

[www.wago.com/210-103](http://www.wago.com/210-103)

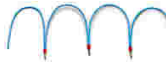

**Item no.: 210-123**  
Wire commoning chain; insulated; 50 connections

[www.wago.com/210-123](http://www.wago.com/210-123)

#### End plate



**Item no.: 2002-1491**  
End and intermediate plate; 0.8 mm thick

[www.wago.com/2002-1491](http://www.wago.com/2002-1491)



**Item no.: 2002-1492**  
End and intermediate plate; 0.8 mm thick

[www.wago.com/2002-1492](http://www.wago.com/2002-1492)



**Item no.: 2002-1493**  
Separator plate; 2 mm thick; oversized

[www.wago.com/2002-1493](http://www.wago.com/2002-1493)



**Item no.: 2002-1494**  
Separator plate; 2 mm thick; oversized

[www.wago.com/2002-1494](http://www.wago.com/2002-1494)



**Item no.: 209-191**  
Separator for Ex e/Ex i applications; 3 mm thick; 120 mm wide

[www.wago.com/209-191](http://www.wago.com/209-191)

#### ferrule



**Item no.: 216-241**  
Ferrule; Sleeve for 0.5 mm<sup>2</sup> / AWG 22; insulated; electro-tin plated; electrolytic copper; gastight crimped; acc. to DIN 46228, Part 4/09.90

[www.wago.com/216-241](http://www.wago.com/216-241)



**Item no.: 216-242**  
Ferrule; Sleeve for 0.75 mm<sup>2</sup> / AWG 20; insulated; electro-tin plated; electrolytic copper; gastight crimped; acc. to DIN 46228, Part 4/09.90

[www.wago.com/216-242](http://www.wago.com/216-242)



**Item no.: 216-243**  
Ferrule; Sleeve for 1 mm<sup>2</sup> / AWG 18; insulated; electro-tin plated; electrolytic copper; gastight crimped; acc. to DIN 46228, Part 4/09.90

[www.wago.com/216-243](http://www.wago.com/216-243)



**Item no.: 216-244**  
Ferrule; Sleeve for 1.5 mm<sup>2</sup> / AWG 16; insulated; electro-tin plated; electrolytic copper; gastight crimped; acc. to DIN 46228, Part 4/09.90

[www.wago.com/216-244](http://www.wago.com/216-244)



**Item no.: 216-246**  
Ferrule; Sleeve for 2.5 mm<sup>2</sup> / AWG 14; insulated; electro-tin plated; electrolytic copper; gastight crimped; acc. to DIN 46228, Part 4/09.90

[www.wago.com/216-246](http://www.wago.com/216-246)



**Item no.: 216-262**  
Ferrule; Sleeve for 0.75 mm<sup>2</sup> / AWG 20; insulated; electro-tin plated; electrolytic copper; gastight crimped; acc. to DIN 46228, Part 4/09.90

[www.wago.com/216-262](http://www.wago.com/216-262)



**Item no.: 216-263**  
Ferrule; Sleeve for 1 mm<sup>2</sup> / AWG 18; insulated; electro-tin plated; electrolytic copper; gastight crimped; acc. to DIN 46228, Part 4/09.90

[www.wago.com/216-263](http://www.wago.com/216-263)



**Item no.: 216-264**  
Ferrule; Sleeve for 1.5 mm<sup>2</sup> / AWG 16; insulated; electro-tin plated; electrolytic copper; gastight crimped; acc. to DIN 46228, Part 4/09.90





[www.wago.com/216-264](http://www.wago.com/216-264)



**Item no.: 216-266**  
Ferrule; Sleeve for 2.5 mm<sup>2</sup> / AWG 14; insulated; electro-tin plated; electrolytic copper; gastight crimped; acc. to DIN 46228, Part 4/09.90

[www.wago.com/216-266](http://www.wago.com/216-266)

### General accessories

	<b>Item no.: 2002-880/1000-411</b> Diode module; with diode 1N4007 As a free-wheeling diode; 10.4 mm wide; Operating temperature 85°C max.	<a href="http://www.wago.com/2002-880/1000-411">www.wago.com/2002-880/1000-411</a>
	<b>Item no.: 2002-880/1000-541</b> LED module; with red LED; 10.4 mm wide; 12 - 30 V; Operating temperature 85°C max.	<a href="http://www.wago.com/2002-880/1000-541">www.wago.com/2002-880/1000-541</a>
	<b>Item no.: 2002-880/1000-542</b> LED module	<a href="http://www.wago.com/2002-880/1000-542">www.wago.com/2002-880/1000-542</a>
	<b>Item no.: 2002-880/1000-836</b> LED module; with red LED; 10.4 mm wide; 230 V; Operating temperature 85°C max.	<a href="http://www.wago.com/2002-880/1000-836">www.wago.com/2002-880/1000-836</a>

### Insulation stop

	<b>Item no.: 2002-171</b> Insulation stop; 0.25 - 0.5 mm <sup>2</sup> ; 5 pieces/strip	<a href="http://www.wago.com/2002-171">www.wago.com/2002-171</a>
	<b>Item no.: 2002-172</b> Insulation stop; 0.75 - 1 mm <sup>2</sup> ; 5 pieces/strip	<a href="http://www.wago.com/2002-172">www.wago.com/2002-172</a>



### Protective Warning Marker

	<b>Item no.: 2002-115</b> Protective warning marker; with high-voltage symbol, black; for 5 terminal blocks	<a href="http://www.wago.com/2002-115">www.wago.com/2002-115</a>
--	--	--

### plug

	<b>Item no.: 2002-880</b> Empty component plug housing; 10.4 mm wide; 2-pole; Type 4	<a href="http://www.wago.com/2002-880">www.wago.com/2002-880</a>
--	---	--

### tools

	<b>Item no.: 210-658</b> Operating tool with partially insulated shaft; Blade (3.5 x 0.5) mm; short; angled	<a href="http://www.wago.com/210-658">www.wago.com/210-658</a>
	<b>Item no.: 210-720</b> Operating tool with partially insulated shaft; Type 2, blade (3.5 x 0.5) mm	<a href="http://www.wago.com/210-720">www.wago.com/210-720</a>

### Downloads

#### Documentation

#### Bid Text

2002-1402	Aug 13, 2018	DOCX	Download
Reihenklennen, TOPJOB S		15.2 kB	



smartDATA

CAD data

3D Download 2002-1402

URL

Download

---

Subject to changes.

---

WAGO Kontakttechnik GmbH & Co. KG

Hansastr. 27

32423 Minden

Phone: +49571 887-0 | Fax: +49571 887-169

Email: [info.de@wago.com](mailto:info.de@wago.com) | Web: [www.wago.com](http://www.wago.com)

Do you have any questions about our products?

We are always happy to take your call at +49 (571) 887-44222.