

Printed-circuit board connector - FK-MC 0,5/ 5-ST-2,5 - 1881354

Please be informed that the data shown in this PDF Document is generated from our Online Catalog. Please find the complete data in the user's documentation. Our General Terms of Use for Downloads are valid (<http://phoenixcontact.com/download>)

Plug component, Nominal current: 4 A, Rated voltage (III/2): 160 V, Number of positions: 5, Pitch: 2.5 mm, Connection method: Push-in spring connection, Color: green, Contact surface: Tin



The figure shows a 10-position version of the product

Why buy this product

- ✓ Time saving push-in connection, tools not required
- ✓ Defined contact force ensures that contact remains stable over the long term
- ✓ Intuitive use through colour coded actuation lever
- ✓ Operation and conductor connection from one direction enable integration into front of device
- ✓ Quick and convenient testing using integrated test option

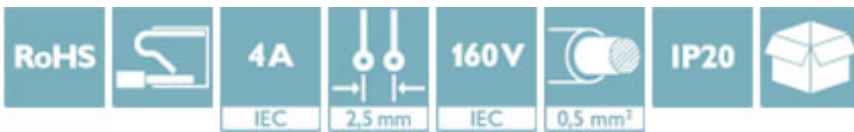

Key Commercial Data

Packing unit	50 STK
Minimum order quantity	50 STK
GTIN	 4 017918 156602
GTIN	4017918156602
Weight per Piece (excluding packing)	2.880 g
Custom tariff number	85366990
Country of origin	Germany

Technical data

Dimensions

Length	19.05 mm
Height	11.75 mm
Width	13.1 mm
Pitch	2.5 mm
Dimension a	10 mm

General

Printed-circuit board connector - FK-MC 0,5/ 5-ST-2,5 - 1881354

Technical data

General

Range of articles	FK-MC 0,5/..-ST
Insulating material group	I
Rated surge voltage (III/3)	1.5 kV
Rated surge voltage (III/2)	2.5 kV
Rated surge voltage (II/2)	2.5 kV
Rated voltage (III/2)	160 V
Rated voltage (II/2)	320 V
Connection in acc. with standard	EN-VDE
Nominal current I _N	4 A
Nominal voltage U _N	100 V
Nominal cross section	0.5 mm ²
Insulating material	PA
Flammability rating according to UL 94	V0
Stripping length	8 mm
Number of positions	5

Connection data

Conductor cross section solid min.	0.14 mm ²
Conductor cross section solid max.	0.5 mm ²
Conductor cross section flexible min.	0.14 mm ²
Conductor cross section flexible max.	0.5 mm ²
Conductor cross section flexible, with ferrule without plastic sleeve min.	0.25 mm ²
Conductor cross section flexible, with ferrule without plastic sleeve max.	0.5 mm ²
Conductor cross section AWG min.	26
Conductor cross section AWG max.	20
Minimum AWG according to UL/CUL	28
Maximum AWG according to UL/CUL	20

Standards and Regulations

Connection in acc. with standard	EN-VDE
	CUL
Flammability rating according to UL 94	V0

Ambient conditions

Ambient temperature (storage/transport)	-40 °C ... 70 °C
Ambient temperature (assembly)	-5 °C ... 100 °C
Ambient temperature (operation)	-40 °C (dependent on the derating curve)

Environmental Product Compliance

China RoHS	Environmentally friendly use period: unlimited = EFUP-e
	No hazardous substances above threshold values

Drawings

Printed-circuit board connector - FK-MC 0,5/ 5-ST-2,5 - 1881354

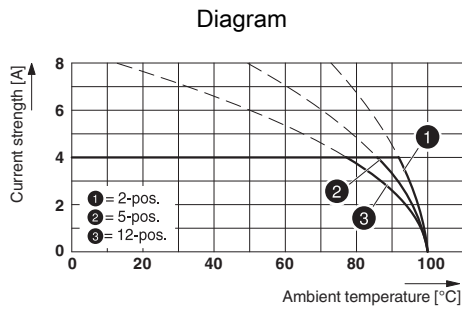

Type: FK-MC 0,5/...-ST-2,5 with MC 0,5/...-G-2,5

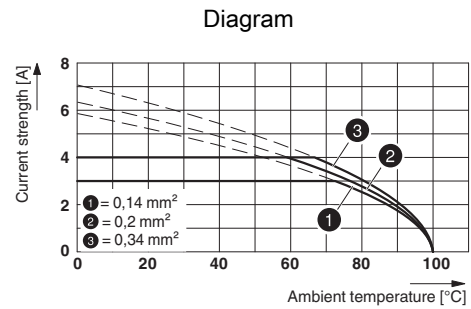

Type: FK-MC 0,5/...-ST-2,5 with MC 0,5/...-G-2,5

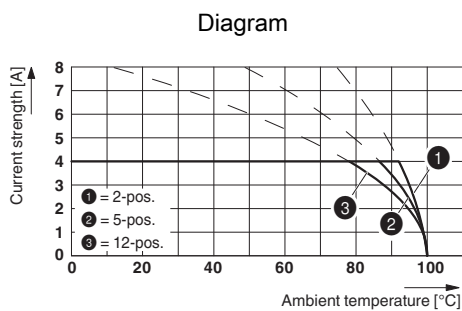

Type: FK-MC 0,5/...-ST-2,5 with MCV 0,5/...-G-2,5 THT

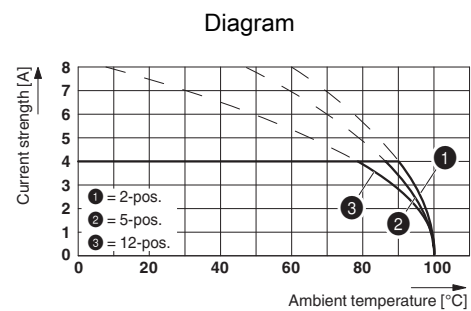

Type: FK-MC 0,5/...-ST-2,5 with MC 0,5/...-G-2,5 THT

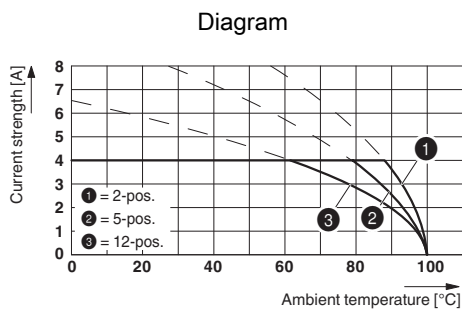

Type: FK-MC 0,5/...-ST-2,5 with MCD 0,5/...-G1-2,5

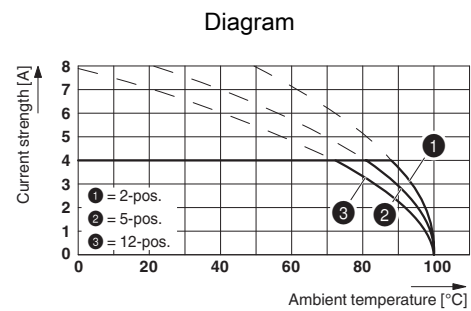

Type: FK-MC 0,5/...-ST-2,5 with MCDV 0,5/...-G1-2,5

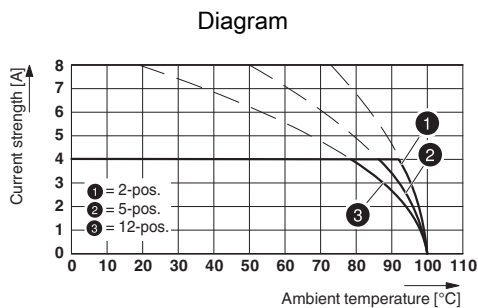

Type: FK-MC 0,5/...-ST-2,5 with MCV 0,5/...-G-2,5

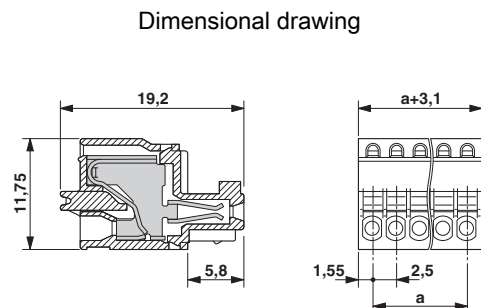

Printed-circuit board connector - FK-MC 0,5/ 5-ST-2,5 - 1881354

Classifications

eCl@ss

eCl@ss 4.0	272607xx
eCl@ss 4.1	27260701
eCl@ss 5.0	27260701
eCl@ss 5.1	27260701
eCl@ss 6.0	27260704
eCl@ss 7.0	27440402
eCl@ss 8.0	27440309
eCl@ss 9.0	27440309

ETIM

ETIM 3.0	EC001121
ETIM 4.0	EC002638
ETIM 5.0	EC002638
ETIM 6.0	EC002638

UNSPSC

UNSPSC 6.01	30211810
UNSPSC 7.0901	39121409
UNSPSC 11	39121409
UNSPSC 12.01	39121409
UNSPSC 13.2	39121409

Approvals

Approvals

Approvals

UL Recognized / VDE Gutachten mit Fertigungsüberwachung / cUL Recognized / IECCEB Scheme / CCA / EAC / cULus Recognized

Ex Approvals

Approval details

UL Recognized		http://database.ul.com/cgi-bin/XYV/template/LISEXT/1FRAME/index.htm	FILE E 60425
		B	
mm ² /AWG/kcmil		28-20	
Nominal current I _N		4 A	
Nominal voltage U _N		125 V	

Printed-circuit board connector - FK-MC 0,5/ 5-ST-2,5 - 1881354

Approvals

VDE Gutachten mit Fertigungsüberwachung		http://www.vde.com/en/Institute/OnlineService/ VDE-approved-products/Pages/Online-Search.aspx	40013394
mm ² /AWG/kcmil	0.2-0.5		
Nominal current IN	4 A		
Nominal voltage UN	100 V		

cUL Recognized		http://database.ul.com/cgi-bin/XYV/template/LISEXT/1FRAME/index.htm	FILE E 60425
		B	
mm ² /AWG/kcmil	28-20		
Nominal current IN	4 A		
Nominal voltage UN	125 V		

IECEE CB Scheme		http://www.iecee.org/	DE1-56068-B1B2
mm ² /AWG/kcmil	0.2-0.5		
Nominal current IN	4 A		
Nominal voltage UN	100 V		

CCA	CCA/ DE1 34250		
mm ² /AWG/kcmil	0.2-0.5		
Nominal current IN	4 A		
Nominal voltage UN	100 V		

EAC		B.01742	
-----	--	---------	--

cULus Recognized		http://database.ul.com/cgi-bin/XYV/template/LISEXT/1FRAME/index.htm	
------------------	--	---	--

Accessories

Accessories

Labeled terminal marker

Printed-circuit board connector - FK-MC 0,5/ 5-ST-2,5 - 1881354

Accessories

Marker card - SK 2,54/2,8:FORTL.ZAHLEN - 0804853



Marker card, Card, white, labeled, Horizontal: Consecutive numbers 1 - 10, 11 - 20, etc. up to 91 - 99, Mounting type: Adhesive, for terminal block width: 2.54 mm, Lettering field: 2.54 x 2.8 mm

Screwdriver tools

Screwdriver - SZS 0,4X2,0 - 1205202



Micro screwdriver, bladed, size: 0.4 x 2.0 x 60 mm, 2-component grip, with non-slip grip and twist cap

Additional products

Base strip - MC 0,5/ 5-G-2,5 - 1881477



Header, Nominal current: 4 A, Rated voltage (III/2): 160 V, Number of positions: 5, Pitch: 2.5 mm, Color: green, Contact surface: Tin, Mounting: Wave soldering

Base strip - MCV 0,5/ 5-G-2,5 - 1881587



Header, Nominal current: 4 A, Rated voltage (III/2): 160 V, Number of positions: 5, Pitch: 2.5 mm, Color: green, Contact surface: Tin, Mounting: Wave soldering

Base strip - MCD 0,5/ 5-G1-2,5 - 1894833



Header, Nominal current: 4 A, Rated voltage (III/2): 160 V, Number of positions: 5, Pitch: 2.5 mm, Color: green, Contact surface: Tin, Mounting: Wave soldering

Printed-circuit board connector - FK-MC 0,5/ 5-ST-2,5 - 1881354

Accessories

Base strip - MCDV 0,5/ 5-G1-2,5 - 1894943



Header, Nominal current: 4 A, Rated voltage (III/2): 160 V, Number of positions: 5, Pitch: 2.5 mm, Color: green, Contact surface: Tin, Mounting: Wave soldering

Printed-circuit board connector - MCD 0,5/ 5-G1-2,5 HT BK - 1961177



Header, Nominal current: 4 A, Rated voltage (III/2): 160 V, Number of positions: 5, Pitch: 2.5 mm, Color: black, Contact surface: Tin, Mounting: THR soldering, Standard component made of highly temperature resistant plastic; suitable for reflow process. User information and design recommendations on Through Hole Reflow Technology can be found at: "Downloads".

Printed-circuit board connector - MCDV 0,5/ 5-G1-2,5 HT BK - 1961274



Header, Nominal current: 4 A, Rated voltage (III/2): 160 V, Number of positions: 5, Pitch: 2.5 mm, Color: black, Contact surface: Tin, Mounting: THR soldering, Standard component made of highly temperature resistant plastic; suitable for reflow process. User information and design recommendations on Through Hole Reflow Technology can be found at: "Downloads".

Printed-circuit board connector - MC 0,5/ 5-G-2,5 THT - 1963450



Header, Nominal current: 4 A, Rated voltage (III/2): 160 V, Number of positions: 5, Pitch: 2.5 mm, Color: black, Contact surface: Tin, Mounting: THR soldering, User information and design recommendations for through hole reflow technology can be found under "Downloads"

Printed-circuit board connector - MCV 0,5/ 5-G-2,5 THT - 1963560



Header, Nominal current: 4 A, Rated voltage (III/2): 160 V, Number of positions: 5, Pitch: 2.5 mm, Color: black, Contact surface: Tin, Mounting: THR soldering, User information and design recommendations for through hole reflow technology can be found under "Downloads"

Printed-circuit board connector - FK-MC 0,5/ 5-ST-2,5 - 1881354

Accessories

Printed-circuit board connector - MC 0,5/ 5-G-2,5 THT R44 - 1963670



Header, Nominal current: 4 A, Rated voltage (III/2): 160 V, Number of positions: 5, Pitch: 2.5 mm, Color: black, Contact surface: Tin, Mounting: THR soldering, User information and design recommendations for through hole reflow technology can be found under "Downloads"

Printed-circuit board connector - MCV 0,5/ 5-G-2,5 THT R44 - 1963780



Header, Nominal current: 4 A, Rated voltage (III/2): 160 V, Number of positions: 5, Pitch: 2.5 mm, Color: black, Contact surface: Tin, Mounting: THR soldering, User information and design recommendations on Through Hole Reflow Technology can be found at: "Downloads"
