

Description

- 3.2 x 1.5mm SMD crystal in a ceramic package with a seam sealed metal lid, hermetically sealed.
- Model IQXC-217
- Model Issue number 1

Frequency Parameters

- Frequency 32.7680kHz
- Frequency Tolerance $\pm 20.00\text{ppm}$
- Tolerance Condition @ 25°C $\pm 5^\circ\text{C}$
- Overtone Order Fundamental
- Ageing $\pm 3\text{ppm max in 1st year @ } 25^\circ\text{C}$

Electrical Parameters

- Load Capacitance (CL) 9.00pF
- Shunt Capacitance (C0) 1.5pF max
- Drive Level 0.1 μW typ, 0.5 μW max
- ESR 70.00k Ω max

Environmental Parameters

- Storage Temperature Range: -55 to 125°C
- Drop: 150g dummy, 180cm drop (6 directions x 3 times) onto concrete board
- Vibration: 1.5mm amplitude, 10Hz-60Hz with cycle time 2-3 minutes in 3 directions (X, Y and Z axis) each for 2 hours

Manufacturing Details

- RoHS Terminations NiAu
- RoHS Reflow Temp 260°C max for 10s max

Compliance

- RoHS Status (2015/863/EU) Compliant
- REACH Status Compliant
- MSL Rating (JDEC-STD-033): Not Applicable

Packaging Details

- Pack Style: Reel Tape & reel in accordance with EIA-481-D
Pack Size: 3,000
- *Alternative packing option available*

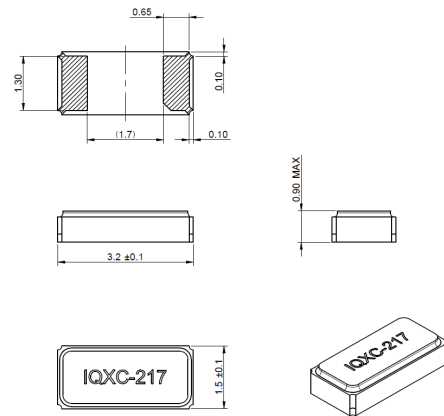
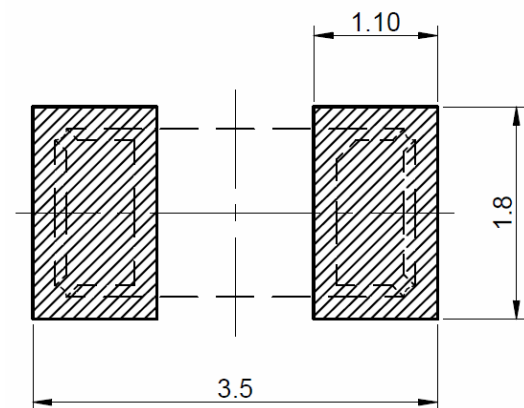
Outline (mm)

Recommended Solder Pad Layout

Sales Office Contact Details:

UK: +44 (0)1460 270200

USA: +1.760.318.2824

 Email: info@iqdfrequencyproducts.com

 Web: www.iqdfrequencyproducts.com

Typical Frequency Stability Characteristics

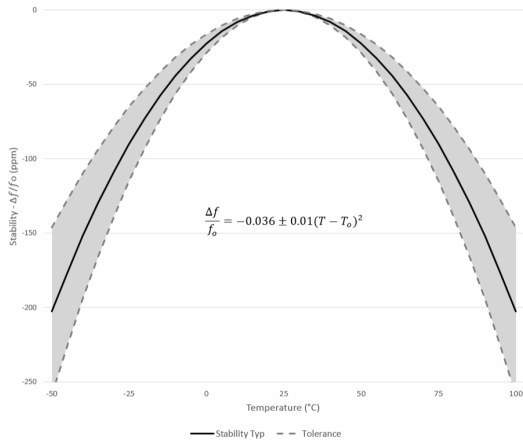

Sales Office Contact Details:

UK: +44 (0)1460 270200

USA: +1.760.318.2824

Email: info@iqdfrequencyproducts.com

Web: www.iqdfrequencyproducts.com