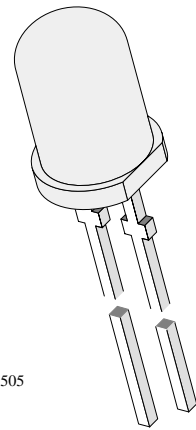


Low Current LED in ø 5 mm Tinted Diffused Package

Color	Type	Technology	Angle of Half Intensity $\pm\varphi$
High efficiency red	TLLR540.	GaAsP on GaP	25°
Yellow	TLLY540.	GaAsP on GaP	25°
Green	TLLG540.	GaP on GaP	25°

Features

- Low power consumption
- High brightness
- CMOS/MOS compatible
- Specified at $I_F = 2 \text{ mA}$
- Luminous intensity categorized
- Yellow and green color categorized



96 11505

Applications

Low power DC circuits

Absolute Maximum Ratings

$T_{amb} = 25^\circ\text{C}$, unless otherwise specified

TLLR540. , **TLLY540.** , **TLLG540.** ,

Parameter	Test Conditions	Symbol	Value	Unit
Reverse voltage		V_R	6	V
DC forward current	$T_{amb} \leq 90^\circ\text{C}$	I_F	7	mA
Surge forward current	$t_p \leq 10 \mu\text{s}$	I_{FSM}	0.15	A
Power dissipation	$T_{amb} \leq 90^\circ\text{C}$	P_V	20	mW
Junction temperature		T_j	100	$^\circ\text{C}$
Operating temperature range		T_{amb}	-40 to +100	$^\circ\text{C}$
Storage temperature range		T_{stg}	-55 to +100	$^\circ\text{C}$
Soldering temperature	$t \leq 5 \text{ s}$, 2 mm from body	T_{sd}	260	$^\circ\text{C}$
Thermal resistance junction/ambient		R_{thJA}	500	K/W

Optical and Electrical Characteristics

$T_{amb} = 25^{\circ}\text{C}$, unless otherwise specified

High efficiency red (TLLR540.)

Parameter	Test Conditions	Type	Symbol	Min	Typ	Max	Unit
Luminous intensity ¹⁾	$I_F = 2 \text{ mA}$	TLLR5400	I_V	0.63	1.2		mcd
		TLLR5401	I_V	1	2		mcd
Dominant wavelength	$I_F = 2 \text{ mA}$		λ_d	612		625	nm
Peak wavelength	$I_F = 2 \text{ mA}$		λ_p		635		nm
Angle of half intensity	$I_F = 2 \text{ mA}$		ϕ		± 25		deg
Forward voltage	$I_F = 2 \text{ mA}$		V_F		1.9	2.4	V
Reverse voltage	$I_R = 10 \mu\text{A}$		V_R	6	20		V
Junction capacitance	$V_R = 0, f = 1 \text{ MHz}$		C_j		50		pF

¹⁾ in one Packing Unit $I_{V\text{Min.}}/I_{V\text{Max.}} \leq 0.5$

Yellow (TLLY540.)

Parameter	Test Conditions	Type	Symbol	Min	Typ	Max	Unit
Luminous intensity ¹⁾	$I_F = 2 \text{ mA}$	TLLY5400	I_V	0.63	1.2		mcd
		TLLY5401	I_V	1	2		mcd
Dominant wavelength	$I_F = 2 \text{ mA}$		λ_d	581		594	nm
Peak wavelength	$I_F = 2 \text{ mA}$		λ_p		585		nm
Angle of half intensity	$I_F = 2 \text{ mA}$		ϕ		± 25		deg
Forward voltage	$I_F = 2 \text{ mA}$		V_F		2.4	2.9	V
Reverse voltage	$I_R = 10 \mu\text{A}$		V_R	6	20		V
Junction capacitance	$V_R = 0, f = 1 \text{ MHz}$		C_j		50		pF

¹⁾ in one Packing Unit $I_{V\text{Min.}}/I_{V\text{Max.}} \leq 0.5$

Green (TLLG540.)

Parameter	Test Conditions	Type	Symbol	Min	Typ	Max	Unit
Luminous intensity ¹⁾	$I_F = 2 \text{ mA}$	TLLG5400	I_V	0.63	1.2		mcd
		TLLG5401	I_V	1	2		mcd
Dominant wavelength	$I_F = 2 \text{ mA}$		λ_d	562		575	nm
Peak wavelength	$I_F = 2 \text{ mA}$		λ_p		565		nm
Angle of half intensity	$I_F = 2 \text{ mA}$		ϕ		± 25		deg
Forward voltage	$I_F = 2 \text{ mA}$		V_F		1.9	2.4	V
Reverse voltage	$I_R = 10 \mu\text{A}$		V_R	6	20		V
Junction capacitance	$V_R = 0, f = 1 \text{ MHz}$		C_j		50		pF

¹⁾ in one Packing Unit $I_{V\text{Min.}}/I_{V\text{Max.}} \leq 0.5$

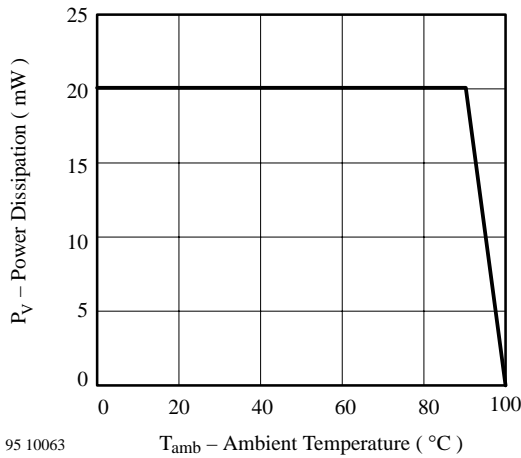
Typical Characteristics ($T_{amb} = 25^{\circ}\text{C}$, unless otherwise specified)


Figure 1. Power Dissipation vs. Ambient Temperature

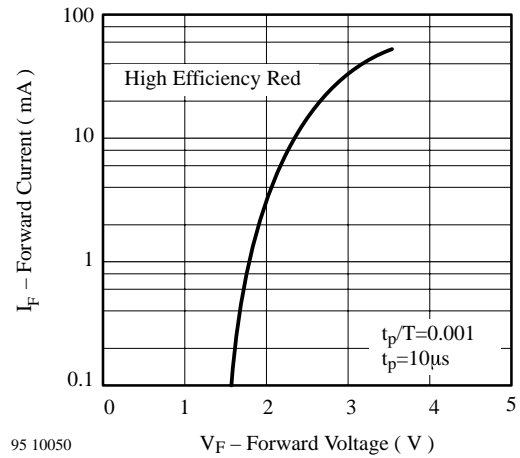


Figure 4. Forward Current vs. Forward Voltage

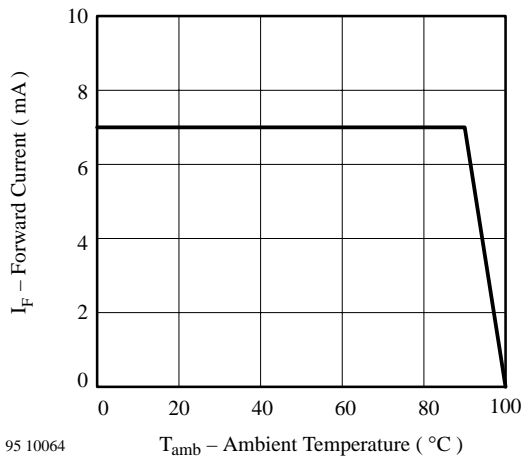


Figure 2. Forward Current vs. Ambient Temperature

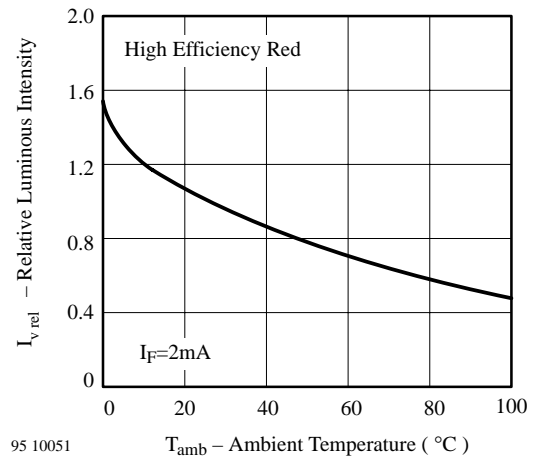


Figure 5. Rel. Luminous Intensity vs. Ambient Temperature

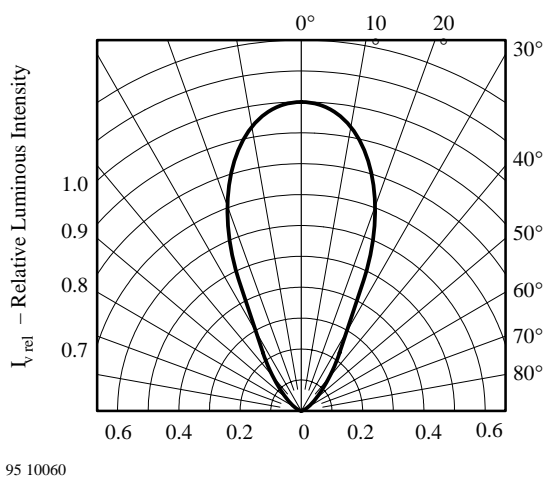


Figure 3. Rel. Luminous Intensity vs. Angular Displacement

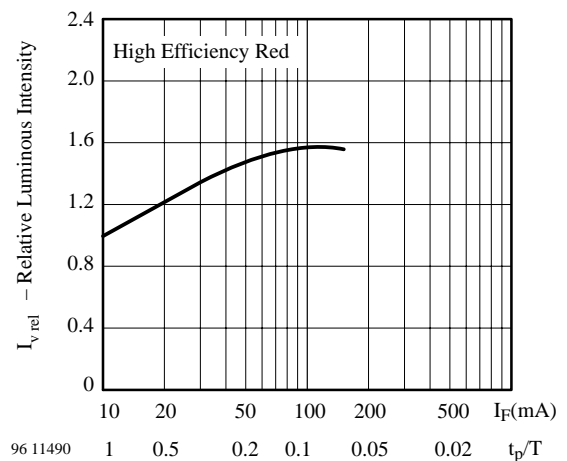


Figure 6. Rel. Lumin. Intensity vs. Forw. Current/Duty Cycle

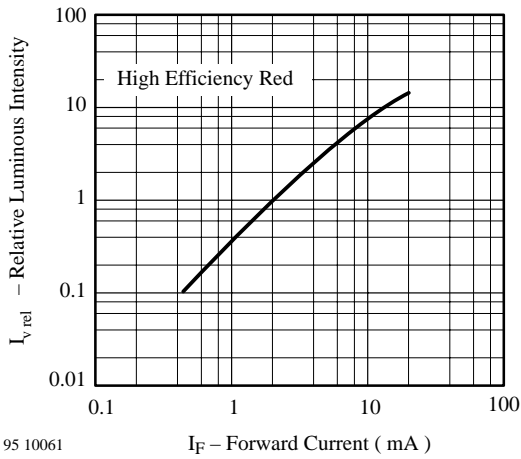


Figure 7. Relative Luminous Intensity vs. Forward Current

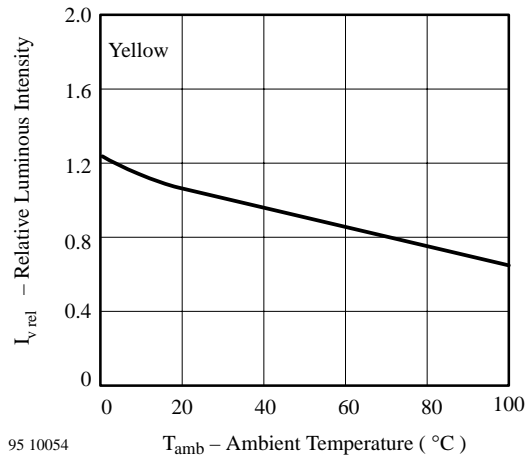


Figure 10. Rel. Luminous Intensity vs. Ambient Temperature

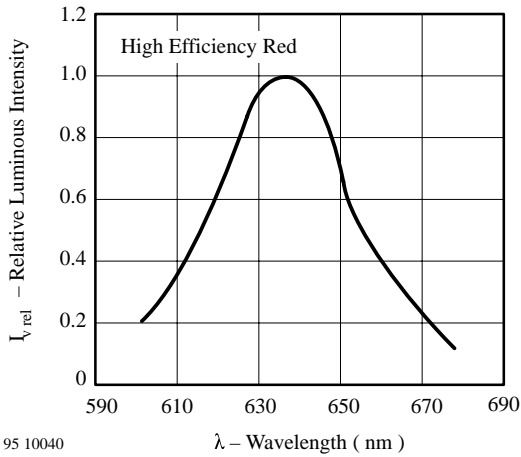


Figure 8. Relative Luminous Intensity vs. Wavelength

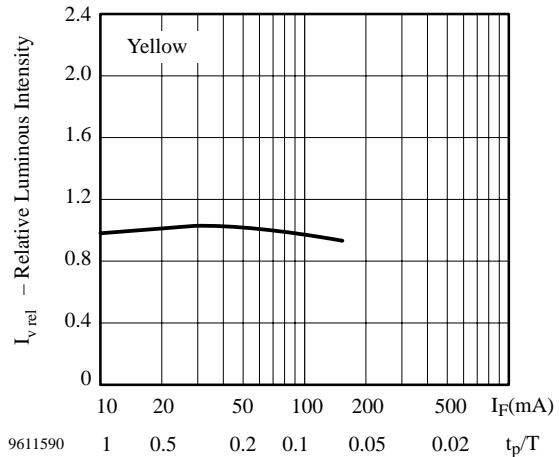


Figure 11. Rel. Lumin. Intensity vs. Forw. Current / Duty Cycle

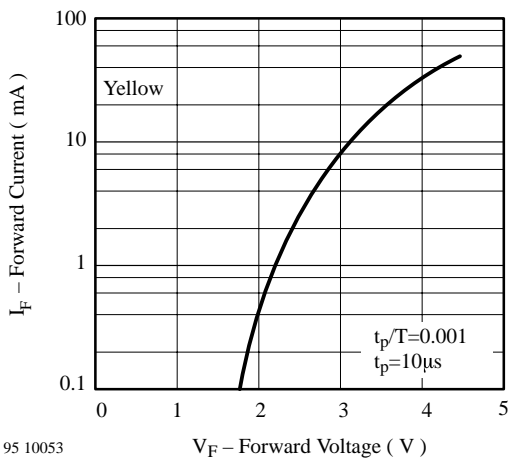


Figure 9. Forward Current vs. Forward Voltage

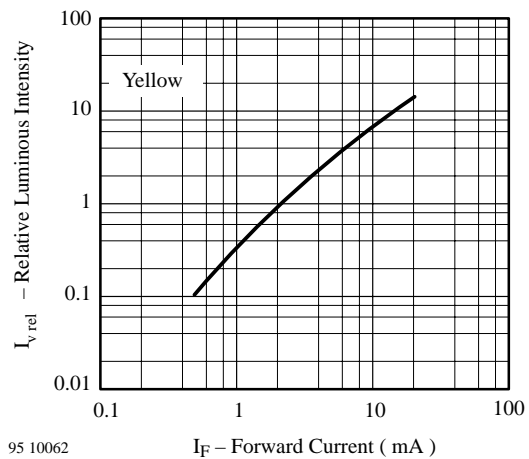


Figure 12. Relative Luminous Intensity vs. Forward Current

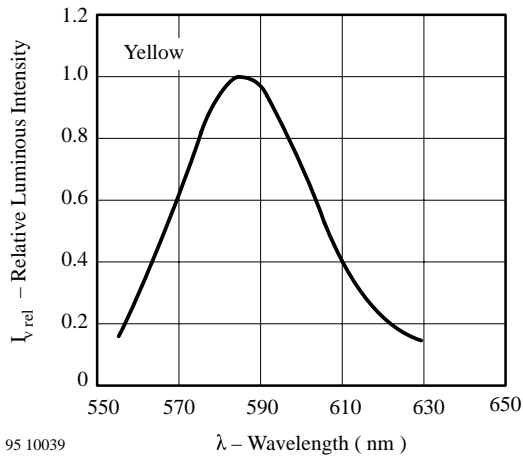


Figure 13. Relative Luminous Intensity vs. Wavelength

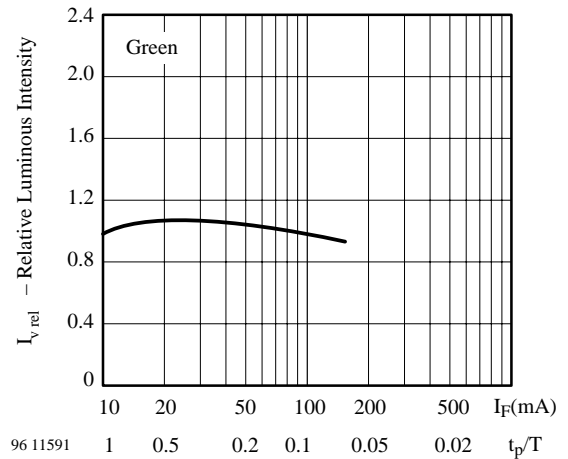


Figure 16. Rel. Lumin. Intensity vs. Forw. Current / Duty Cycle

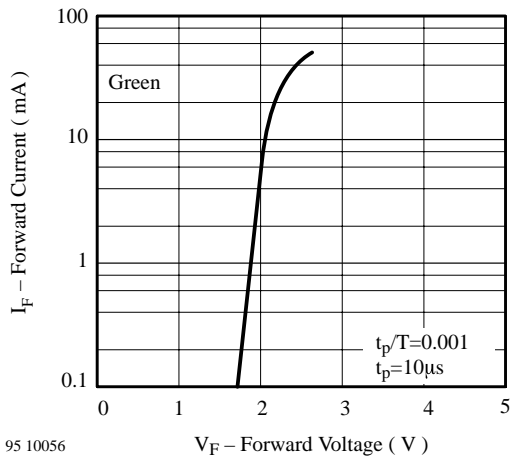


Figure 14. Forward Current vs. Forward Voltage

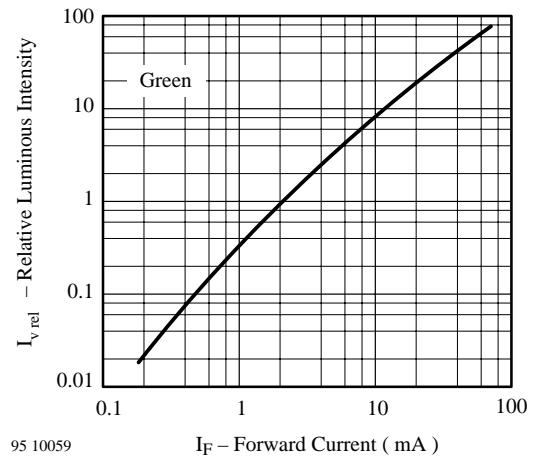


Figure 17. Relative Luminous Intensity vs. Forward Current

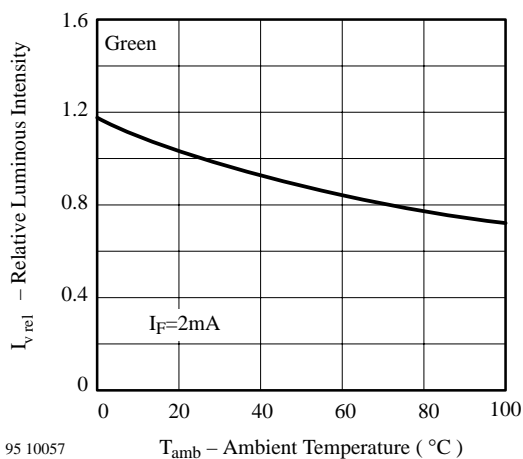


Figure 15. Rel. Luminous Intensity vs. Ambient Temperature

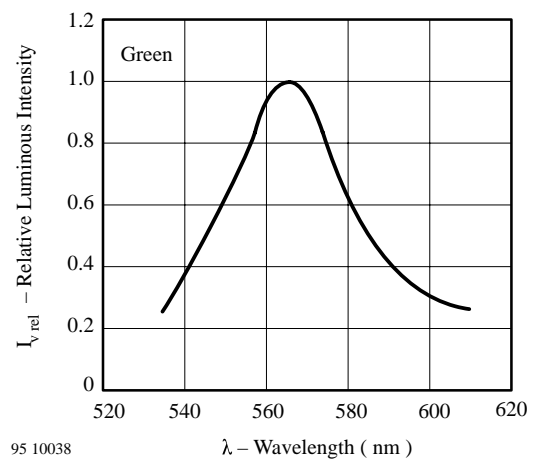
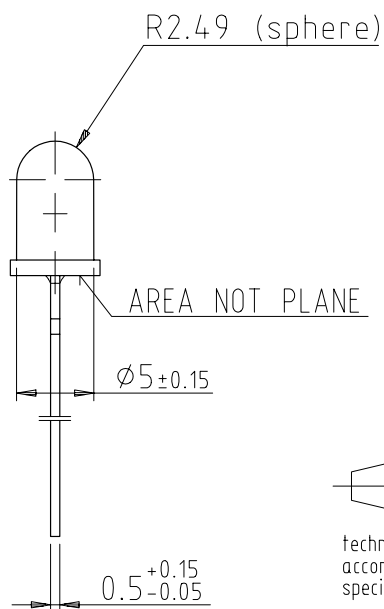
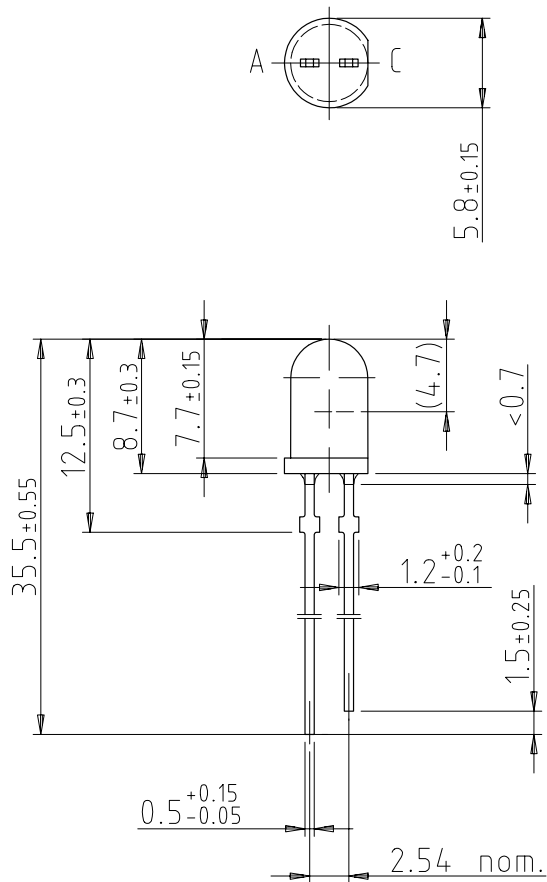
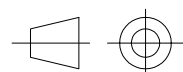


Figure 18. Relative Luminous Intensity vs. Wavelength

Dimensions in mm



95 10916



technical drawings
according to DIN
specifications



Ozone Depleting Substances Policy Statement

It is the policy of **Vishay Semiconductor GmbH** to

1. Meet all present and future national and international statutory requirements.
2. Regularly and continuously improve the performance of our products, processes, distribution and operating systems with respect to their impact on the health and safety of our employees and the public, as well as their impact on the environment.

It is particular concern to control or eliminate releases of those substances into the atmosphere which are known as ozone depleting substances (ODSs).

The Montreal Protocol (1987) and its London Amendments (1990) intend to severely restrict the use of ODSs and forbid their use within the next ten years. Various national and international initiatives are pressing for an earlier ban on these substances.

Vishay Semiconductor GmbH has been able to use its policy of continuous improvements to eliminate the use of ODSs listed in the following documents.

1. Annex A, B and list of transitional substances of the Montreal Protocol and the London Amendments respectively
2. Class I and II ozone depleting substances in the Clean Air Act Amendments of 1990 by the Environmental Protection Agency (EPA) in the USA
3. Council Decision 88/540/EEC and 91/690/EEC Annex A, B and C (transitional substances) respectively.

Vishay Semiconductor GmbH can certify that our semiconductors are not manufactured with ozone depleting substances and do not contain such substances.

We reserve the right to make changes to improve technical design and may do so without further notice.

Parameters can vary in different applications. All operating parameters must be validated for each customer application by the customer. Should the buyer use Vishay-Telefunken products for any unintended or unauthorized application, the buyer shall indemnify Vishay-Telefunken against all claims, costs, damages, and expenses, arising out of, directly or indirectly, any claim of personal damage, injury or death associated with such unintended or unauthorized use.

Vishay Semiconductor GmbH, P.O.B. 3535, D-74025 Heilbronn, Germany
Telephone: 49 (0)7131 67 2831, Fax number: 49 (0)7131 67 2423