

## M12 MALE 90° / M12 FEMALE 90° LED

PUR 5X0.34 black UL/CSA, ROBOT, drag ch 0.6m

Male 90° to female 90°

M12 - M12, 5-pole

3 × LED (PNP), (NPN) on request

Art.-No. 7005 - M12 Lite - (plastic hexagonal screw) on request

Plastic housings with good resistance against chemicals and oils. The resistance to aggressive media should be individually tested for your application. Further details on request. Further cable lengths on request.

### [Link to Product](#)

#### Illustration

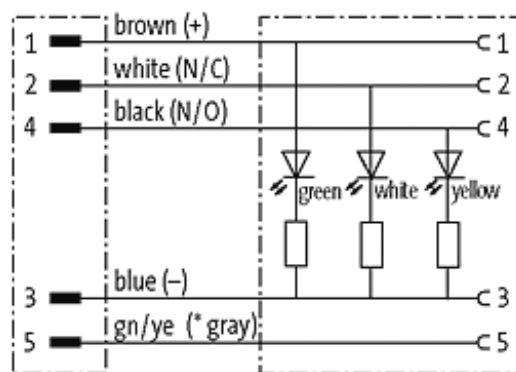

(\* for cable type 126 and 732)

Male

Female

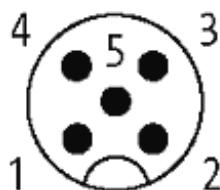

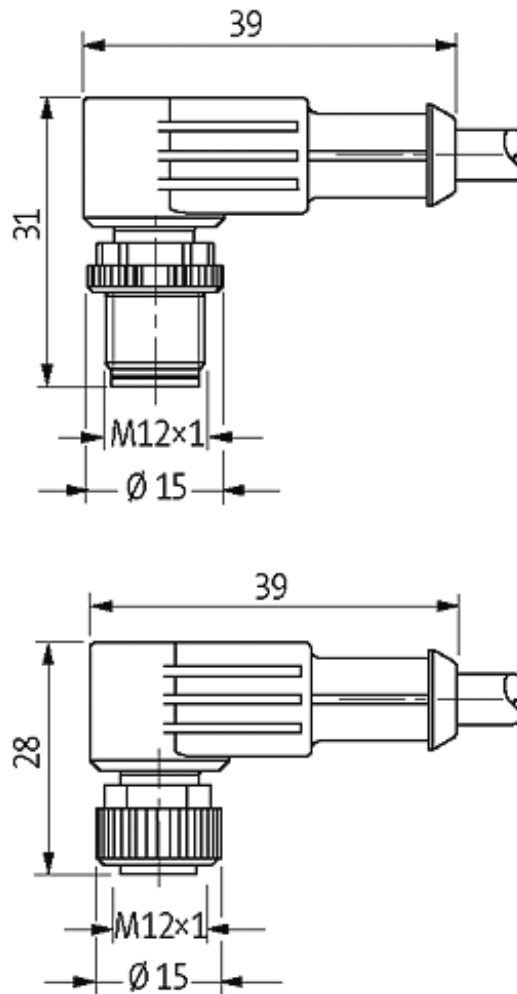

Product may differ from Image

### Approvals



### Form

40441

### Technical Data

Protection	IP67 inserted and tightened (EN 60529)
Operating voltage	max. 30 V DC
Operating current per contact	max. 4 A
Locking of ports	Screw thread M12 × 1 mm (recommended torque 0.6 Nm) self-securing

### Cables

Cable number	655
No./diameter of wires	5 × 0.34 mm <sup>2</sup>
Wire isolation	PP (br, wh, bl, bk, gnye)

C-track properties	10 Mio.
Torsion	1 Mio. $\pm$ 360°/m
Jacket Color	black
Shore hardness outer jacket	58 $\pm$ 3D
Material (jacket)	PUR (UL/CSA), welding spark res.
Outer diameter	approx. 5.0 mm
Bend radius (fixed)	5 $\times$ outer $\varnothing$
Bend radius (moving)	10 $\times$ outer $\varnothing$
Temperature range (fixed)	-40...+90 °C
Temperature range (mobile)	-25...+90 °C

#### General data

Temperature range	-25...+85 °C, depending on cable quality
-------------------	--

#### Commercial data

country of origin	DE
customs tariff number	85444290
minimum order quantity	1