



SWITCH-DISCONNECTOR 100A, FRAME SIZE 2, 3-POLE FRONT OPERATING CENTER BASIC UNIT WITHOUT HANDLE FLAT TERMINAL INCL. PHASE BARRIERS

Model		
product brand name		SENTRON
Product designation		Switching device
Design of the product		3KD switch disconnectors
Design of the operating mechanism		without
Design of handle		without
Type of the driving mechanism / motor drive		No
General technical data		
Number of poles		3
Type of device		fixed mounting
circuit-breaker / Design		3KD3
Mechanical service life (switching cycles) / typical		15 000
Overvoltage category		III
Voltage		
Insulation voltage / Rated value	V	1 000
Surge voltage resistance / Rated value	kV	8
Protection class		
Protection class IP		IP00
Protection class IP / on the front		IP00
Dissipation		
Active power loss		
<ul style="list-style-type: none"> with conventional rated thermal current / per pole 	W	3

Electricity

Continuous current		
• Rated value	A	100
• at 40 °C / Rated value	A	100
• at 45 °C / Rated value	A	100
• at 50 °C / Rated value	A	100
• at 55 °C / Rated value	A	100
• at 60 °C / Rated value	A	100
• at 65 °C / Rated value	A	100
• at 70 °C / Rated value	A	100
Short-time current resistance (I _{cw}) / limited to 1 s / Rated value	kA	4

Main circuit

Operating power		
• at AC-23 A / at 400 V / at 50/60 Hz / Rated value	kW	55
• at AC-23 A / at 500 V / at 50/60 Hz / Rated value	kW	55
• at AC-23 A / at 690 V / at 50/60 Hz / Rated value	kW	90
Operating voltage		
• with AC / at 50/60 Hz / Rated value	V	690

Auxiliary circuit

Number of CO contacts / for auxiliary contacts		4
Number of NC contacts / for auxiliary contacts		0
Number of NO contacts / for auxiliary contacts		0

Suitability

Suitability for use		
• Main switch		Yes
• switch disconnecter		Yes
• EMERGENCY OFF switch		No
• safety switch		Yes
• maintenance/repair switch		Yes

Product details

Product feature / interlock		No
Product component		
• Trip indicator		No
• Voltage trigger		No
• undervoltage release		No
• undervoltage release with leading contact		No
Product expansion		

• Auxiliary switch	Yes
• optional	
— motor drive	No
— Voltage trigger	No

Connections

Type of electrical connection

• for main current circuit	flat connector
----------------------------	----------------

Mechanical Design

Height	mm	168
Width	mm	121
Depth	mm	68
mounting position		any
Mounting type		Floor mounting and snap-on mounting to 35 mm standard mounting rail
Mounting type		
• front mounting with 4-hole attachment		No
• front mounting with central attachment		No
• rail mounting		Yes

Environmental conditions

Ambient temperature

• during operation / minimum	°C	-25
• during operation / maximum	°C	70
• during storage / minimum	°C	-50
• during storage / maximum	°C	80

Certificates

Equipment marking / acc. to DIN EN 61346-2

Q

General Product Approval

Declaration of Conformity



Further information

Information- and Downloadcenter (Catalogs, Brochures,...)

<http://www.siemens.com/lowvoltage/catalogs>

Industry Mall (Online ordering system)

<https://eb.automation.siemens.com/mall/en/WW/Catalog/Product/3KD30300NE200>

Service&Support (Manuals, Certificates, Characteristics, FAQs,...)

<http://support.automation.siemens.com/WW/view/en/3KD30300NE200/all>

Image database (product images, 2D dimension drawings, 3D models, device circuit diagrams, ...)

http://www.automation.siemens.com/bilddb/cax_en.aspx?mlfb=3KD30300NE200

CAX-Online-Generator

<http://www.siemens.com/cax>

Tender specifications

<http://ausschreibungstexte.siemens.com/tiplv>

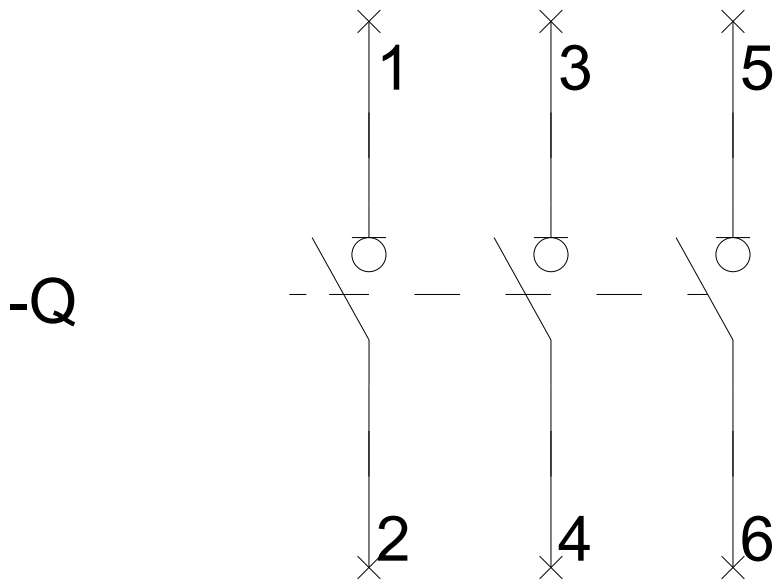
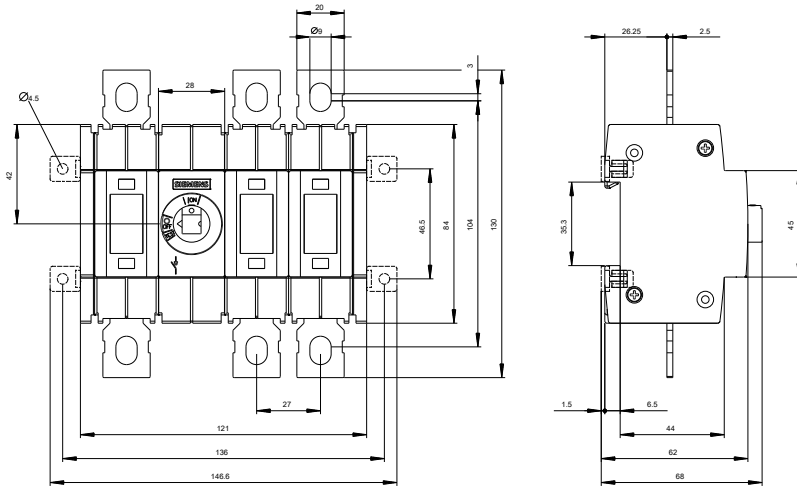

last modified:

11.03.2015