

SITOR SWITCH DISCONNECTOR 10X38, UP TO 32 A,
690 V AC



Figure similar

Model		
product brand name		SENTRON
Design of the operating mechanism		others
General technical data		
Number of poles		1
Size of fuse link		Other
Protection class		
Protection class IP / on the front		Other
Electricity		
Continuous current / Rated value	A	32
Main circuit		
Operating voltage / with AC / Rated value / maximum	V	690
Suitability		
Suitability for use		
• Main switch		No
• switch disconnector		Yes
• EMERGENCY OFF switch		No
• safety switch		Yes
Product function		
Product function / fuse monitoring		No
Short circuit		
Conditional short-circuit current (I _q) / Rated value	kA	50

Connections

Type of electrical connection / for main current circuit screw-type terminals

Mechanical Design

Height mm 58

Depth mm 85

Mounting type

- floor mounting No
- front mounting Yes
- rail mounting No

General Product Approval

Declaration of Conformity



CCC



CSA



GOST



UL



EG-Konf.

other

[other](#)

Further information

Information- and Downloadcenter (Catalogs, Brochures,...)

<http://www.siemens.com/lowvoltage/catalogs>

Industry Mall (Online ordering system)

<https://eb.automation.siemens.com/mall/en/WW/Catalog/Product/3NC1091>

Service&Support (Manuals, Certificates, Characteristics, FAQs,...)

<http://support.automation.siemens.com/WW/view/en/3NC1091/all>

Image database (product images, 2D dimension drawings, 3D models, device circuit diagrams, ...)

http://www.automation.siemens.com/bilddb/cax_en.aspx?mfb=3NC1091

CAX-Online-Generator

<http://www.siemens.com/cax>

Tender specifications

<http://ausschreibungstexte.siemens.com/tiplv>

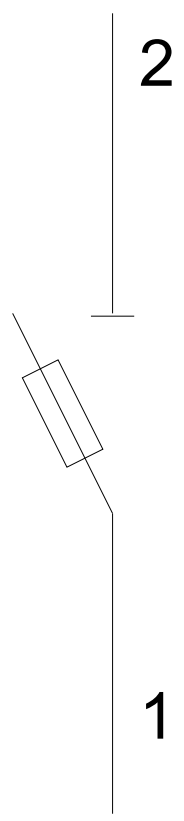
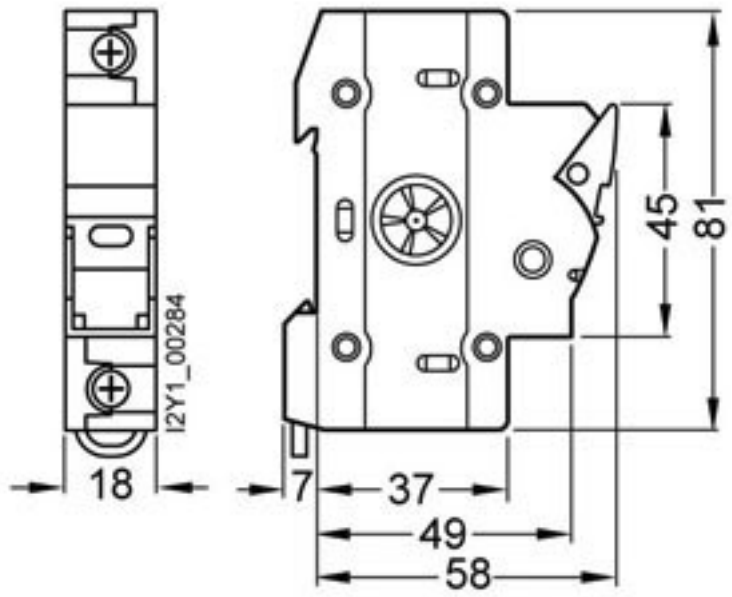

last modified:

11.03.2015