

# E40263

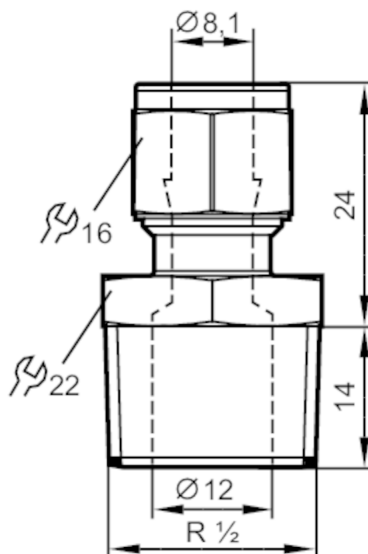

## Progressive ring fitting

COMPRESSION FITTING R1/2



### Application

Pressure rating [bar] 50

### Mechanical data

Weight [g] 79.5

Materials stainless steel (1.4404 / 316L)

Sensor connection Ø 8 mm

Process connection R 1/2

### Remarks

Pack quantity 1 pcs.