

RK46C VarOS

Retro-reflective photoelectric sensors

Dimensioned drawing

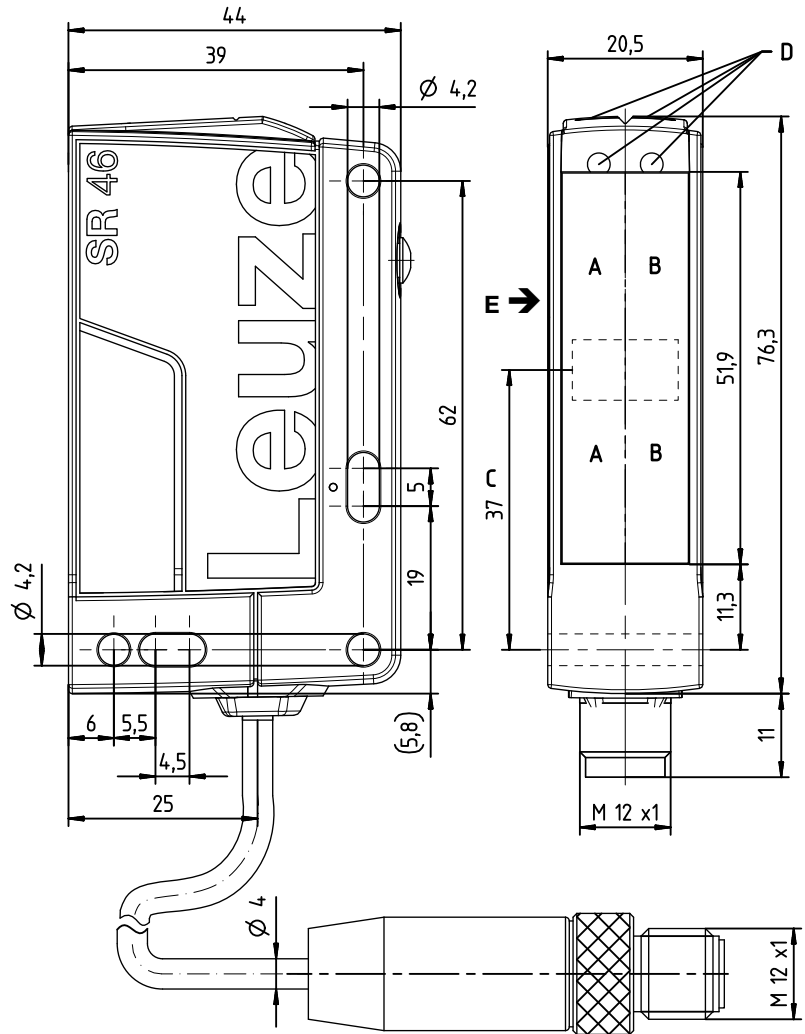

- A Transmitter side
- B Receiver side
- C Center of light-band
- DA Green indicator diode
- DB Yellow indicator diode
- E Preferred entry direction for precise positioning

Electrical connection

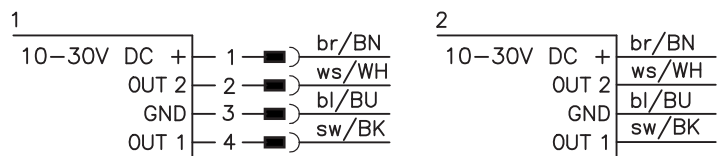

0.4 ... 5.2m

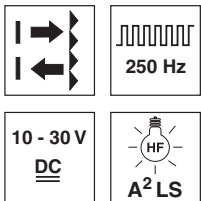

- Sensor with homogeneous light-band (red light) for reliable detection of objects with different sizes and shapes
- Teachable, preset sensitivity levels for time-saving, optimum adaptation to object size, shape and form
- *Easy tune* – calibration of the sensor to e.g. transparent, perforated or small objects
- Precise alignment thanks to the special shape and form of the light-band
- Reliable detection even with depolarizing media (e.g. foil packaging)
- Light/dark switching via the teach button

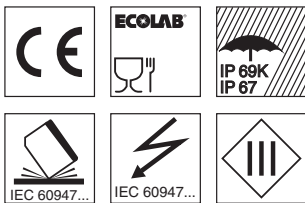

Accessories:

(available separately)

- Mounting systems (BT 46, BTU 300M, BTU 900M)
- M12 connectors (KD ...)
- Ready-made cables (KD ...)
- Reflectors

We reserve the right to make changes • PAL_RK46CDXL3_en_50125880_01.fm

en 03-2018/01 50125880-01

Technical data

Optical data

Typ. op. range limit (TK(S) 100x100) ¹⁾	0.4 ... 5.2m
Operating ranges ²⁾	See tables
Light source ³⁾	LED (modulated light)
Wavelength	620nm (visible red light)
Detection range	Light-band approx. 50mm (see diagrams)
Resolution	Typ. 12mm (max. approx. 8mm) ⁴⁾

Timing

Switching frequency	250 Hz
Response time	2ms
Readiness delay	< 300ms

Electrical data

Operating voltage U _B	10 ... 30VDC (incl. residual ripple)
Residual ripple	≤ 15% of U _B
Open-circuit current	≤ 20mA
Switching outputs/functions	/4P 2 PNP switching outputs, antivalent
	/4X 1 PNP switching output, light switching
	/PX 1 PNP switching output, dark switching
	/2N 2 NPN switching outputs, antivalent
	≥ (U _B -2V)/≤ 2V
Signal voltage high/low	Max. 100mA
Output current	Adjustment via teach button
Sensitivity	

Indicators

Green LED	Ready
Yellow LED	Light path free
Flashing green/yellow LEDs	Feedback during teach procedure

Mechanical data

Housing	Plastic (PC-PBT)
Connector	Plastic (PBT)
Optics	Plastic (PMMA)
Operation	Teach button
Weight	With M12 connector: approx. 60g
	With 200mm cable and M12 connector: approx. 80g
	With 2000mm cable: approx. 100g
Connection type	M12 connector, 4-pin
	Cable 200mm with M12 connector, 4-pin
	Cable 2000mm, 4 x 0.20mm ²

Environmental data

Ambient temp. (operation/storage)	-40°C ... +60°C/-40°C ... +70°C
Protective circuit ⁵⁾	2, 3
VDE protection class ⁶⁾	III
Degree of protection	IP67, IP 69K
Light source	Exempt group (in acc. with EN 62471)
Standards applied	IEC 60947-5-2
Chemical resistance	Tested in accordance with ECOLAB

- 1) Typ. operating range limit: max. attainable range without function reserve
- 2) Operating range: recommended range with function reserve
- 3) Average life expectancy 100,000h at an ambient temperature of 25°C
- 4) Depends on teach-in, see diagrams (sensitivity **increased** ≤ 12 mm)
- 5) 2=polarity reversal protection, 3=short circuit protection for all transistor outputs
- 6) Rating voltage 50V

Notes

- Function reserve decreases as sensitivity increases.
- Max. resolution: approx. 8mm.
- Further applications:
 - Detection of transparent media
 - Detection of depolarizing media, e.g. foil packaging
 - Use as muting sensor
- Multiple sensors can be operated in a small area

Tables

Plastic reflectors:

Reflectors	Operating range
1 TK(S) 100x100	0.4 ... 4.0m
2 TK(S) 40x60	0.4 ... 3.0m

1	0.4	4.0	5.2
2	0.4	3.0	3.9

- Operating range [m]
- Typ. operating range limit [m]

TK ... = adhesive
TKS ... = screw type

Diagrams

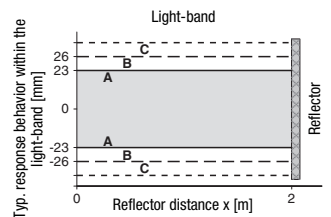

Reference object for detection: 19mm with reflector TKS 100x100

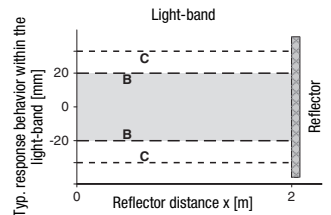

Reference object for detection: 12mm with reflector TKS 40x60

- A Standard** sensitivity
- B Increased** sensitivity
- C Further increased** sensitivity with **Easy tune** (range depends on taught value)

Notes

Observe intended use!

- ⚠ This product is not a safety sensor and is not intended as personnel protection.
- ⚠ The product may only be put into operation by competent persons.
- ⚠ Only use the product in accordance with its intended use.

RK46C VarOS

Retro-reflective photoelectric sensors

Part number code

R K 4 6 C . D X L 3 / 4 P - M 1 2

Operating principle

RK Retro-reflective photoelectric sensor

Series

46C 46C series

Equipment

D Depolarizing media

Optical characteristic

XL Large light spot

Setting

3 Teach button

Pin assignment of OUT1 (connector pin 4 / black cable wire)

2 NPN, light switching

N NPN, dark switching

4 PNP, light switching

P PNP, dark switching

Pin assignment of OUT2 (connector pin 2 / white cable wire)

X Not assigned

2 NPN, light switching

N NPN, dark switching

4 PNP, light switching

P PNP, dark switching

Connection technology

M12 M12 connector, 4-pin

200-M12 Cable 200mm with M12 connector, 4-pin

Free Cable 2000mm

Order guide

The sensors listed here are preferred types; current information at www.leuze.com.

		Designation	Part no.
With M12 connector, 4-pin	OUT1: PNP light switching, OUT2: PNP dark switching	RK46C.DXL3/4P-M12	50125752
	OUT1: PNP dark switching, OUT2: not connected	RK46C.DXL3/PX-M12	50125991
	OUT1: NPN light switching, OUT2: NPN dark switching	RK46C.DXL3/2N-M12	50126764
With 200 mm cable and M12 connector, 4-pin	OUT1: PNP light switching, OUT2: PNP dark switching	RK46C.DXL3/4P-200-M12	50125755
With cable, cable length 2m	OUT1: PNP light switching, OUT2: PNP dark switching	RK46C.DXL3/4P	50125754

Precise alignment of sensor

The special shape and form of the light-band allows precise alignment of the sensor with the object to be detected or with the reflector.

Advantages:

- Maximum utilization of the light-band
- Reliable detection even with shocks/vibrations

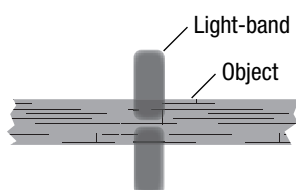

Align center of light-band with center of object/reflector!



Reliable detection of different objects and objects with cutouts and openings, here commissioned merchandise:

- Shrink-wrapped packages (film)
- Gaps between packaging units
- Irregular stacks



Teach procedure for sensor



Note

It is essential to teach the sensor before it is used for the first time!
The sensor is factory-set to the maximum operating range.

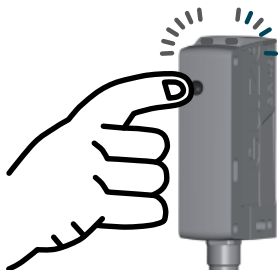
Before starting the teach procedure, align the light-band of the sensor with the center of the object and reflector!

	Teach	
Sensor sensitivity	Standard	Increased
Switching behavior	Sensor switches when 28 % of light-band is covered by object.	Sensor switches when 18 % of light-band is covered by object.
Typical application	Reliable detection of transport material	Detection of containers with openings / transparent objects
Setting	<p>Clear light path to reflector!</p> <p>Press teach button (2 to 7s) until both LEDs (green/yellow) flash synchronously.</p> <p>Release teach button – ready.</p> 	<p>Clear light path to reflector!</p> <p>Press teach button (7 to 12s) until both LEDs (green/yellow) flash alternately.</p> <p>Release teach button – ready.</p> 
Acknowledgment	Teach successful: Both LEDs (green/yellow) remain lit.	
	Teach not successful: Yellow LED flashes. Repeat teach procedure.	

Easy tune – Fine adjustment of sensor sensitivity (switching threshold)

Easy tune allows you to adjust the sensor sensitivity in small steps using the teach button during normal operation.

Increase sensitivity (reduce switching threshold)	Briefly press teach button (2 to 200ms), sensitivity is increased slightly and switching threshold is reduced slightly.	<p>The sensor confirms button actuation by brief illumination (1x flash) of both LEDs.</p> 
Reduce sensitivity (increase switching threshold)	Press and hold teach button (200 ms to 2s), sensitivity is reduced slightly and switching threshold is increased slightly.	

If the upper or lower end of the adjustment range is reached, both LEDs flash at a much higher frequency.

Light/dark switching – Adjustment of switching behavior of switching outputs

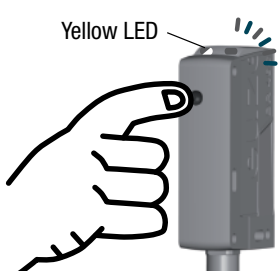
Light/dark switching	<p>Press teach button (> 12s) until green LED flashes.</p> <p>The yellow LED indicates the current setting of the switching outputs¹⁾:</p> <p>ON = Output OUT1 light switching Output OUT2 dark switching</p> <p>OFF = Output OUT1 dark switching Output OUT2 light switching</p> <p>Release teach button – switchover is complete.</p> <p>¹⁾For factory settings, see part number code</p>	<p>Yellow LED</p> 
-----------------------------	---	---