

## M12 female 90° with cable RPP

PVC 3x0.75 gy 7,5m

M12

Female 90°

3-pole with 2 × LED (PNP)

Invers-polarity protection

Plastic housings with good resistance against chemicals and oils. The resistance to aggressive media should be individually tested for your application. Further details on request. Further cable lengths on request.

### [Link to Product](#)

#### Illustration

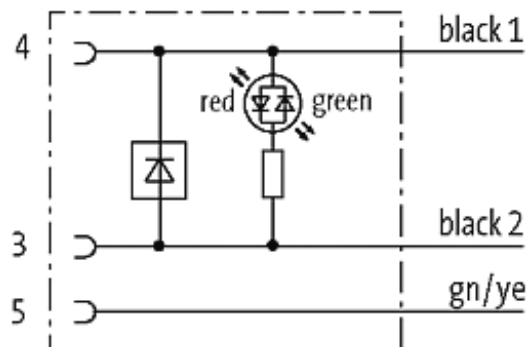
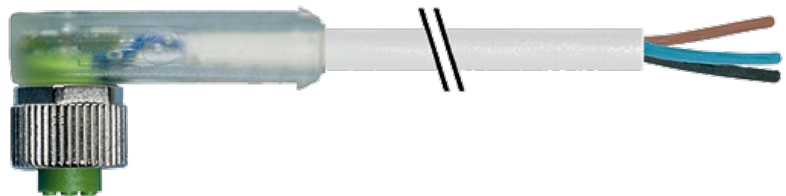

## Female

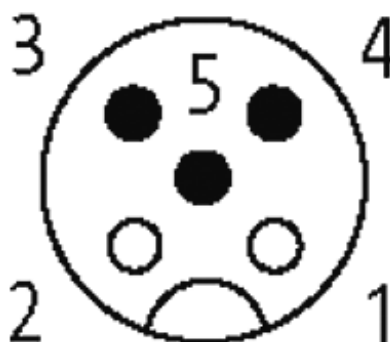

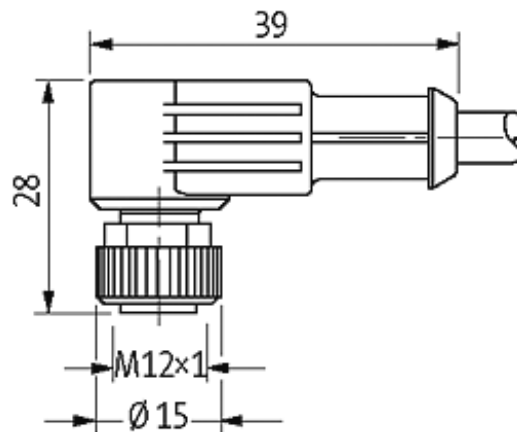

Product may differ from Image

### Approvals



### Form

13701

### Technical Data

Operating voltage	24 V DC $\pm 15\%$
Operating current per contact	max. 4 A
Locking of ports	Screw thread M12 $\times$ 1 mm (recommended torque 0.6 Nm) self-securing
Protection	IP67 inserted and tightened (EN 60529)

### Cables

Cable number	216
No./diameter of wires	3 $\times$ 0.75 mm <sup>2</sup>
Wire isolation	PVC (bk, num, gnye)
Jacket Color	gray
Shore hardness outer jacket	80 $\pm$ 5A
Material (jacket)	PVC
Outer diameter	approx. 5.9 mm
Bend radius (fixed)	5 $\times$ outer $\varnothing$
Bend radius (moving)	10 $\times$ outer $\varnothing$
Temperature range (fixed)	-30...+70 °C
Temperature range (mobile)	-5...+70 °C

### General data

Temperature range	-25...+85 °C, depending on cable quality
-------------------	--

### Commercial data

The information in this brochure has been compiled with the utmost care.

Liability for the correctness completeness and topicality of the information is restricted to gross negligence. Version: 05/15

Murrelektronik GmbH | Falkenstraße 3, 71570 Oppenweiler | Fon +49 (71 91) 47-0, Fax +49 (71 91) 47-491000 | shop@murrelektronik.de | shop.murrelektronik.de

country of origin	DE
customs tariff number	85444290
minimum order quantity	1