

## M12 MALE 90° / MSUD VALVE PLUG FORM A 18MM

PUR 5X0.34 YELLOW, UL/CSA, drag ch 1m

Form A (18 mm) – M12, male 90°  
for pressure switches  
LED (red/green)  
5-pole

Further cable lengths on request. Plastic housings with good resistance against chemicals and oils. The resistance to aggressive media should be individually tested for your application. Further details on request.

### [Link to Product](#)

#### Illustration

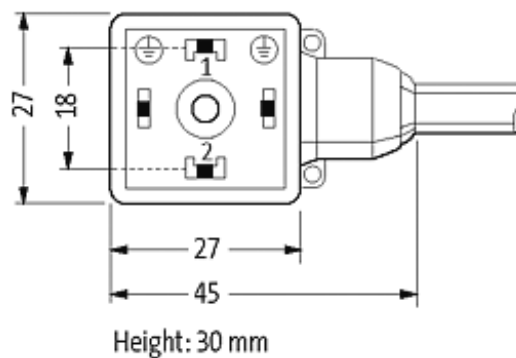
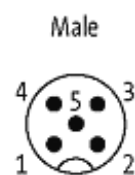
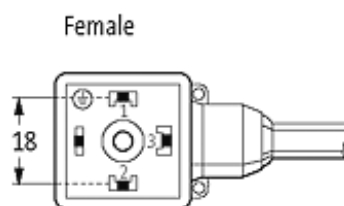
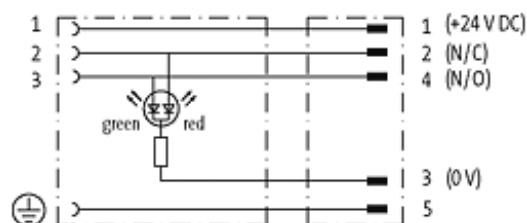
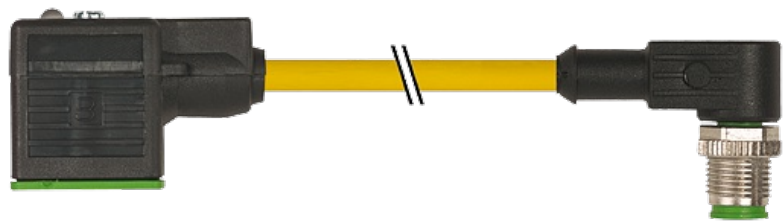

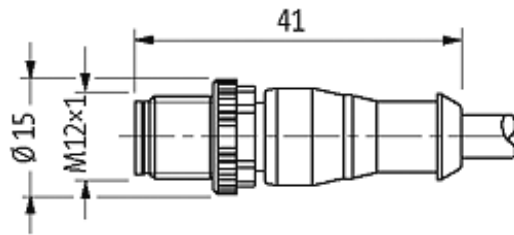

Product may differ from Image

### Approvals



### Technical Data

Operating voltage	24 V AC/DC ±25 %
Operating current per contact	max. 4 A
Current consumption	approx. 12 mA
Housing	Black plastic (gray on request)
Locking of ports	M3/M12 × 1 mm (recommended torque 0.4/0.6 Nm)
Protection	IP67 inserted and tightened (EN 60529)

### Cables

Cable number	035
No./diameter of wires	5 × 0.34 mm <sup>2</sup>
Wire isolation	PP (br, wh, bl, bk, gnye)
C-track properties	5 Mio.
Torsion	2 Mio. ± 180°/m
Jacket Color	yellow
Shore hardness outer jacket	90 ± 5A
Material (jacket)	PUR (UL/CSA)
Outer diameter	approx. 5.0 mm
Bend radius (moving)	10 × outer Ø
Temperature range (fixed)	-40...+80 °C
Temperature range (mobile)	-25...+80 °C

### General data

Temperature range	-25...+85 °C, depending on cable quality
-------------------	--

### Commercial data

country of origin	DE
customs tariff number	85444290
minimum order quantity	1