

M12 MALE 0° / M12 FEMALE 90° 8 POLE

PUR 8x0,25 GRAY, UL/CSA, drag ch 5m

Male straight to female 90°

M12 - M12, 8-pole

Art.-No. 7005 - M12 Lite - (plastic hexagonal screw) on request

Plastic housings with good resistance against chemicals and oils. The resistance to aggressive media should be individually tested for your application. Further details on request. Further cable lengths on request.

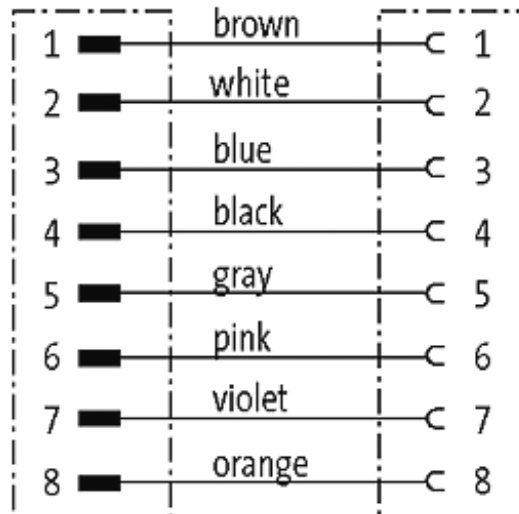
[Link to Product](#)**Illustration**

Male

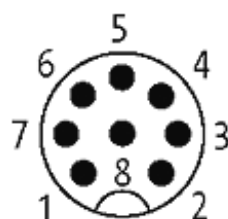

Female

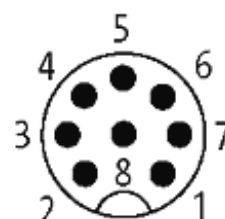

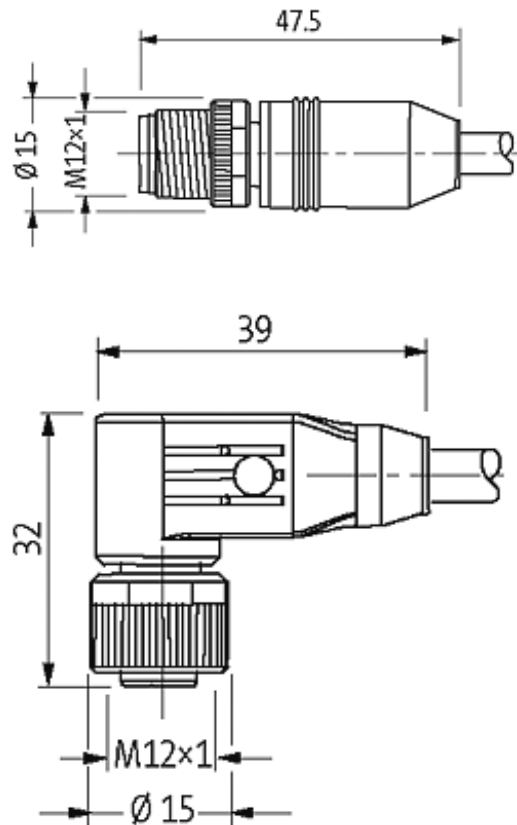

Product may differ from Image

Approvals



* only for products with UL/CSA approved cable

Form

48011

Technical Data

Operating voltage	max. 30 V AC/DC
Operating current per contact	max. 2 A
Locking of ports	Screw thread M12 × 1 mm (recommended torque 0.6 Nm) self-securing
Protection	IP67 inserted and tightened (EN 60529)

Cables

Cable number	295
No./diameter of wires	8 × 0.25 mm ²
Wire isolation	PP (br, wh, bl, bk, gr, pk, vi, or)
C-track properties	2 Mio.
Torsion	± 180°/m

Jacket Color	gray
Shore hardness outer jacket	85 ± 5A
Material (jacket)	PUR (UL/CSA)
Outer diameter	approx. 6.0 mm
Bend radius (fixed)	7.5 × outer Ø
Bend radius (moving)	10 × outer Ø
Temperature range (fixed)	-40...+80 °C
Temperature range (mobile)	-20...+80 °C

Commercial data

country of origin	DE
customs tariff number	85444290
minimum order quantity	1