

Ultra Compact and Versatile Filtered Power Entry Module



- Single stage filter
- Ultra compact design
- Rated currents up to 10 A
- dual-fuse holder
- Fuses Ø5x20mm
- 2-pole rocker switch
- Good attenuation performance
- Faston or spring cage terminals



Check the video of our IEC Inlet Filters FN 9280 and FN 9290 on Youtube!

Performance indicators

Attenuation performance



Rated current [A]



Technical specifications

Mechanical life	50,000 cycles
High potential test voltage	P → PE 2000 VAC for 2 sec (standard types) P → PE 2500 VAC for 2 sec (B types) P → N 760 VAC for 2 sec
MTBF @ 40°C/230 V (Mil-HB-217F)	>1,000,000 hours
Temperature range (operation and storage)	- 25°C to +85°C (25/85/21)
Design corresponding to	UL 1283, CSA 22.2 No. 8 1986, EN 60939, EN 60950, EN 60601-1, UL 544, EN 60320
Flammability corresponding to	UL 94 V-2 or better
Maximum continuous operating voltage	250 VAC, 50/60 Hz
Rated currents	1 to 10 A @ 40°C max.
Operating frequency	dc to 400 Hz
Switch ratings	
USA (UL) and Canada (C-UL)	10 A, 125 VAC; 10 A, 250 VAC; 1/3 HP
Europe (ENEC)	10 A (4 A), 250 VAC**
Electrical specifications	Inrush current 82 A 6,000 on-off operations according to UL 1054 10,000 on-off operations according to ENEC
Leakage current	Standard: <500 uA at 250 VAC/50 Hz Medical: <5 uA at 250 VAC/50 Hz
Protection category	IP 40 according to IEC 60529 (front side)
Fuse holder	2 fuses (Ø5 x 20 mm) max. 250 V
Terminals	IP 20 spring cage safe against finger touch
Spring cage wire range	0.2 - 1.5 mm ² / 24 - 16 AWG single or flexible wire
Rocker switch	2-pole, dark not illuminated, Marking I - 0

* 10 A version is 8 A UL and CSA approved

** Value in () relates to the inductive current charge: cos γ = 0.65

Approvals



(CQC except HI-types; Patent US 20110227692/US 8766761; CN ZL201080069589.0)

Choosing FN 9280/90 product line brings you the rapid availability of a standard filter associated with the necessary safety acceptances and a high attenuation performance. For higher attenuation performance the FN 9290 family with a dual stage filter and identical panel cut-out can be used.

Standard IEC connector filters are a practical solution to pass EMI system approval in a short time. A wide selection of amperage ratings, mounting possibilities and also filters for medical applications are designed to offer you the best solution.

Features and benefits

- Good conducted attenuation performance, based on chokes with high saturation resistance and excellent thermal behavior
- Deep-drawn iron-sheet housing for best possible shielding against magnetic fields
- Rear/front flange mounting or snap-in versions
- Dual fuse holder
- 2-pole rocker switch
- Faston or spring cage terminals for more flexible assembly
- Medical version (B Type) according to IEC/EN 60601-1
- Spare fuse holder



Typical applications

- Portable electrical and electronic equipment
- Consumer goods
- EDP and office equipment
- Single-phase power supplies, switch-mode power supplies
- Test and measurement equipment
- Medical electrical devices (MD) and *In-Vitro*-Diagnostics (IVD) equipment

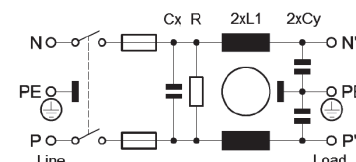
Typical electrical schematic FN 9280 Standard types (B types without Cy)



Filter selection table

Filter*	Rated current @ 40°C [A]	Leakage current** @ 250 V ~/50 Hz [µA]	Inductance		Capacitance		Resistance [kOhm]	Output connections		Weight [g]
			L1 [mH]	L2	Cx [nF]	R				
FN 9280-1-..	1	311	10.9	0	220	2.2	1000	-06	-100	101
FN 9280-2-..	2	311	4.4	0	220	2.2	1000	-06	-100	102
FN 9280-4-..	4	311	1.7	0	220	2.2	1000	-06	-100	105
FN 9280-6-..	6	311	0.78	0	220	2.2	1000	-06	-100	104
FN 9280-10-..	10	311	0.32	0	220	2.2	1000	-06	-100	106
FN 9280 B-1-..	1	2	10.9	0	220	0	1000	-06	-100	101
FN 9280 B-2-..	2	2	4.4	0	220	0	1000	-06	-100	102
FN 9280 B-4-..	4	2	1.7	0	220	0	1000	-06	-100	105
FN 9280 B-6-..	6	2	0.78	0	220	0	1000	-06	-100	104
FN 9280 B-10-..	10	2	0.32	0	220	0	1000	-06	-100	106
FN 9289-1-..	1	311	10.9	0	220	2.2	1000	-06	-100	101
FN 9289-2-..	2	311	4.4	0	220	2.2	1000	-06	-100	102
FN 9289-4-..	4	311	1.7	0	220	2.2	1000	-06	-100	105
FN 9289-6-..	6	311	0.78	0	220	2.2	1000	-06	-100	104
FN 9289-10-..	10	311	0.32	0	220	2.2	1000	-06	-100	106
FN 9289 B-1-..	1	2	10.9	0	220	0	1000	-06	-100	101
FN 9289 B-2-..	2	2	4.4	0	220	0	1000	-06	-100	102
FN 9289 B-4-..	4	2	1.7	0	220	0	1000	-06	-100	105
FN 9289 B-6-..	6	2	0.78	0	220	0	1000	-06	-100	104
FN 9289 B-10-..	10	2	0.32	0	220	0	1000	-06	-100	106
FN 9280 E-1-..	1	311	10.9	0.4	220	2.2	1000	-06	-100	135
FN 9280 E-2-..	2	311	4.4	0.4	220	2.2	1000	-06	-100	136
FN 9280 E-4-..	4	311	1.66	0.4	220	2.2	1000	-06	-100	137
FN 9280 E-6-..	6	311	0.78	0.4	220	2.2	1000	-06	-100	138
FN 9280 E-10-..	10	311	0.32	0.4	220	2.2	1000	-06	-100	139
FN 9280 EB-1-..	1	2	10.9	0.4	220	0	1000	-06	-100	135
FN 9280 EB-2-..	2	2	4.4	0.4	220	0	1000	-06	-100	136
FN 9280 EB-4-..	4	2	1.66	0.4	220	0	1000	-06	-100	137
FN 9280 EB-6-..	6	2	0.78	0.4	220	0	1000	-06	-100	138
FN 9280 EB-10-..	10	2	0.32	0.4	220	0	1000	-06	-100	139
FN 9289 E-1-..	1	311	10.9	0.4	220	2.2	1000	-06	-100	135
FN 9289 E-2-..	2	311	4.4	0.4	220	2.2	1000	-06	-100	136
FN 9289 E-4-..	4	311	1.66	0.4	220	2.2	1000	-06	-100	137
FN 9289 E-6-..	6	311	0.78	0.4	220	2.2	1000	-06	-100	138
FN 9289 E-10-..	10	311	0.32	0.4	220	2.2	1000	-06	-100	139
FN 9289 EB-1-..	1	2	10.9	0.4	220	0	1000	-06	-100	135
FN 9289 EB-2-..	2	2	4.4	0.4	220	0	1000	-06	-100	136
FN 9289 EB-4-..	4	2	1.66	0.4	220	0	1000	-06	-100	137
FN 9289 EB-6-..	6	2	0.78	0.4	220	0	1000	-06	-100	138
FN 9289 EB-10-..	10	2	0.32	0.4	220	0	1000	-06	-100	139

* To compile a complete part number, please replace the -.. with the required output connection style (e.g. FN 9289-1-06, FN 9282-4-100)

** Maximum leakage current under normal conditions according to IEC 60939-1 Ed. 3 at 250 V AC.

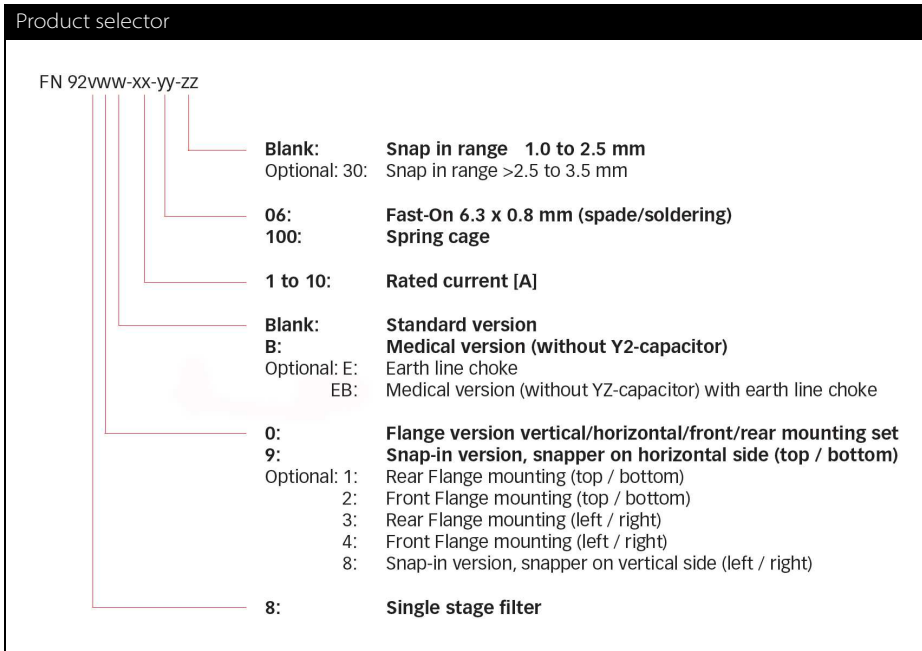

All FN 9280/FN 9290 are equipped with a dual fuse holder with a spare fuse holder.

Note: All FN 9280/FN 9280 B/FN 9289/FN 9289 B/FN 9290/FN 9290 B/FN 9299/FN 9299 B are stock types from our distribution partners.

Order Examples:

FN 9280 B-6-100: Medical version of single stage, dual fuse EMC/EMI filter, flange set for vertical/horizontal/front/rear mounting, 6 A, spring cage terminals, from stock available.

FN 9298-6-06-30: Dual stage, dual fuse EMC/EMI filter, snap-in version, snappers for snap-in panel thickness range >2.5 to 3.5 mm, snapper on vertical side, 6 A, fast-on terminals, non-stock order type

Typical filter attenuation

FN 9280 Series | Per CISPR 17; A=50 Ω/50 Ω sym; B=50 Ω/50 Ω asym

1 A types

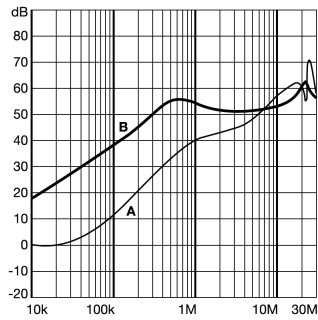

2 A types

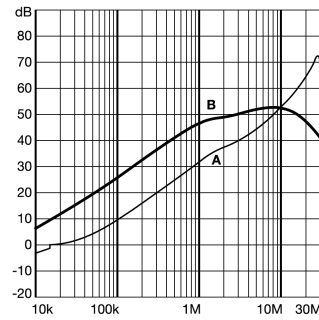

4 – 6 A types

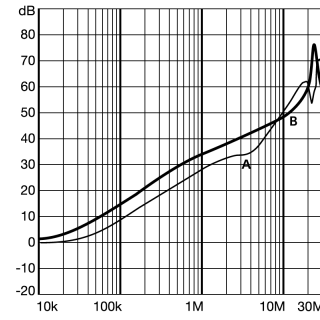

10 A types

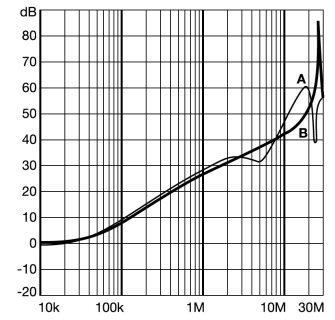

FN 9280 B Series | Per CISPR 17; A=50 Ω/50 Ω sym; B=50 Ω/50 Ω asym

1 A types

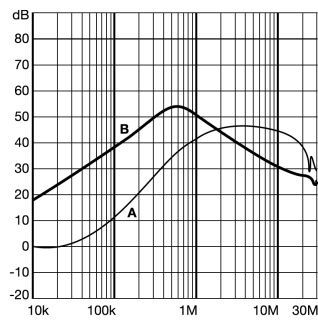

2 A types

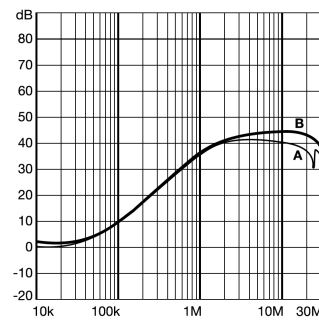

4 – 6 A types

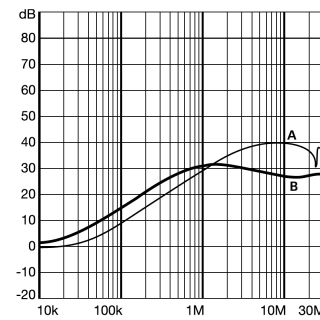

10 A types

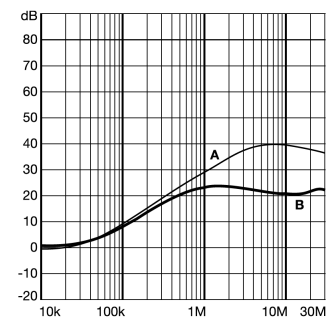

FN 9280 E Series | Per CISPR 17; A=50 Ω/50 Ω sym; B=50 Ω/50 Ω asym

1 A types

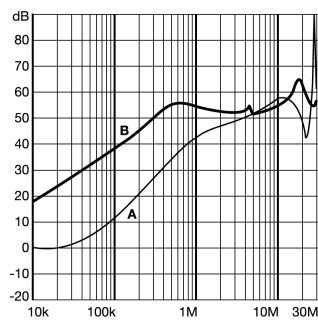

2 A types

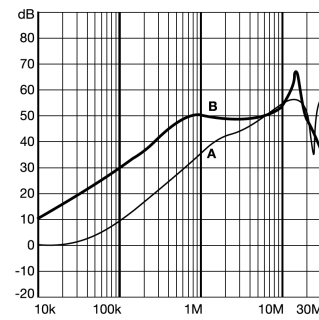

4 – 6 A types

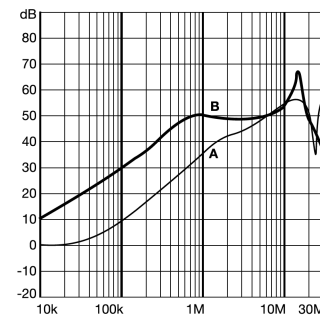

10 A types

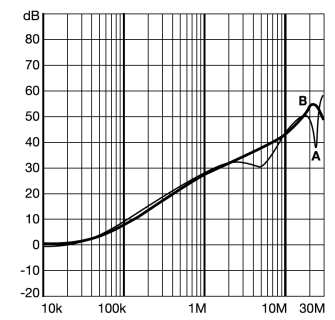

FN 9280 BE Series | Per CISPR 17; A=50 Ω/50 Ω sym; B=50 Ω/50 Ω asym

1 A types

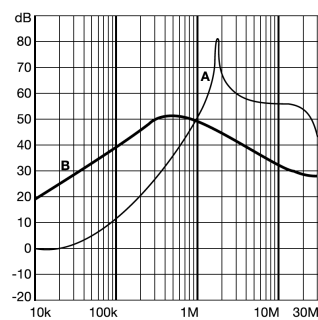

2 A types

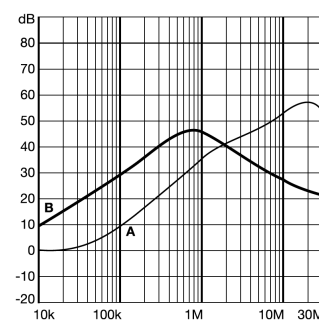

4 – 6 A types

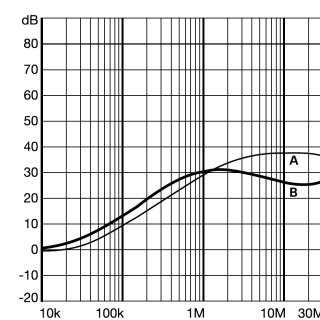

10 A types

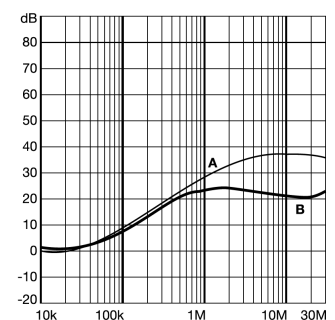

Mechanical Data

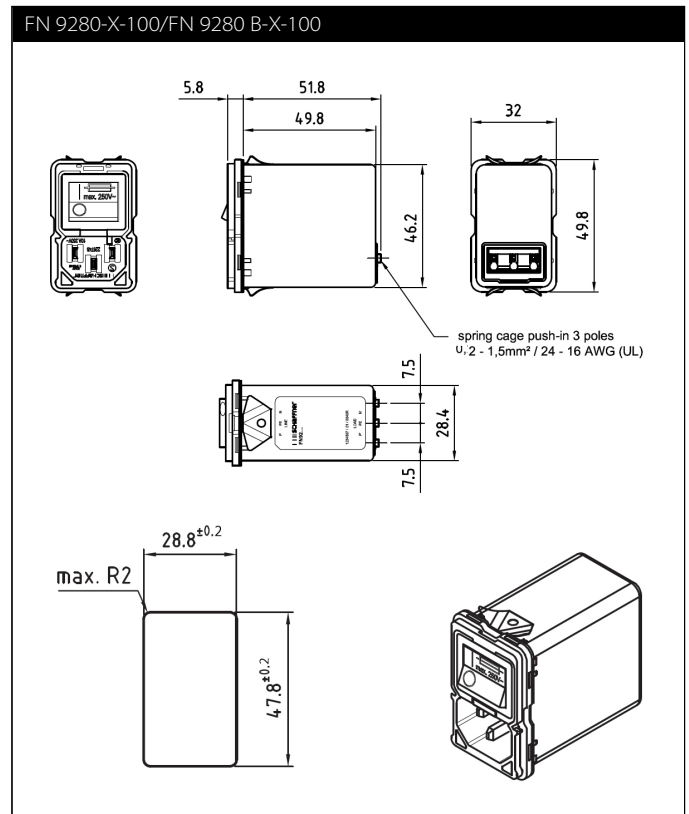
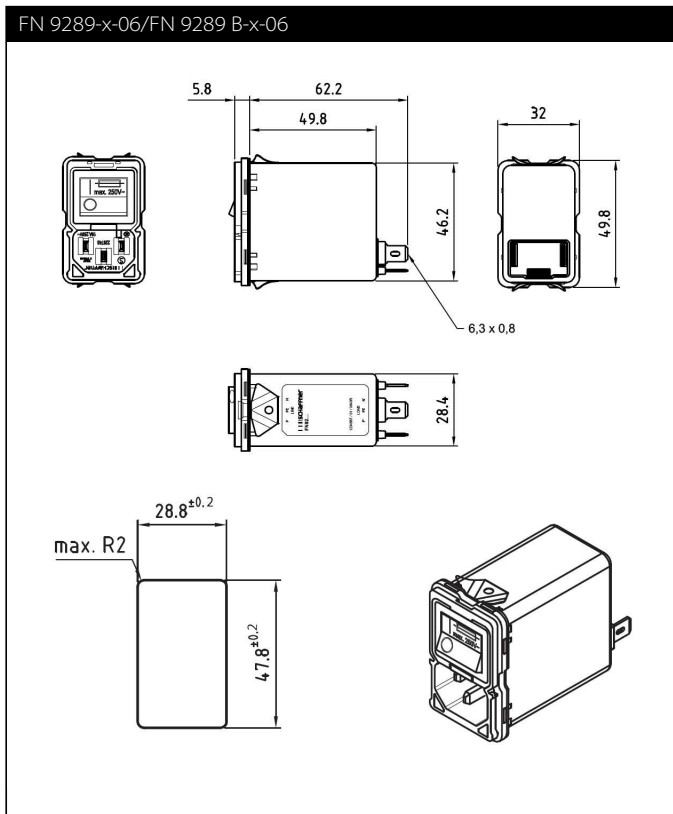
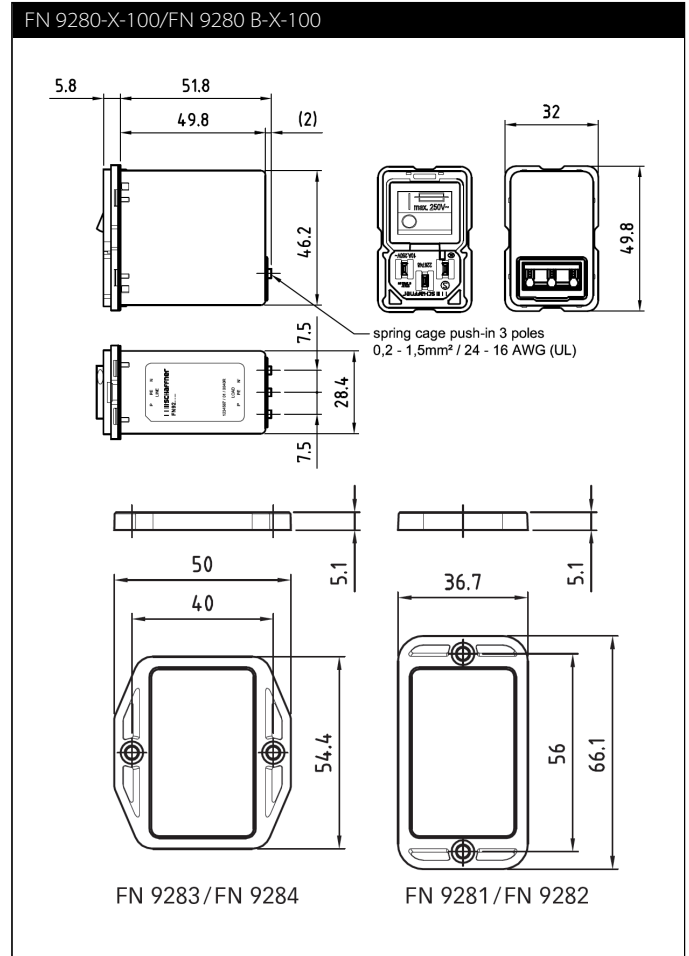
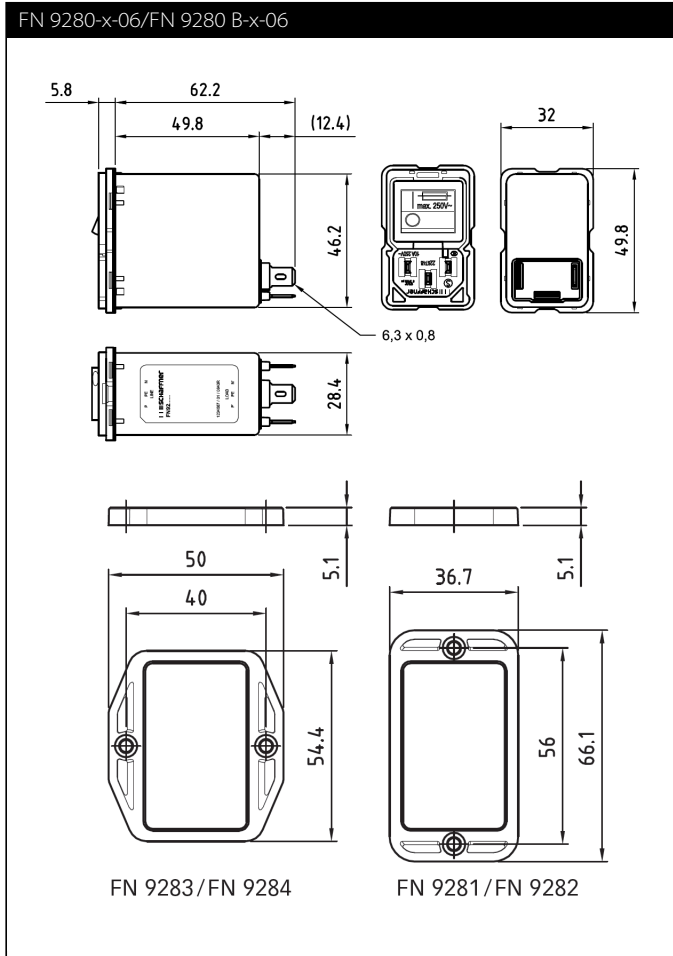

Mechanical Data

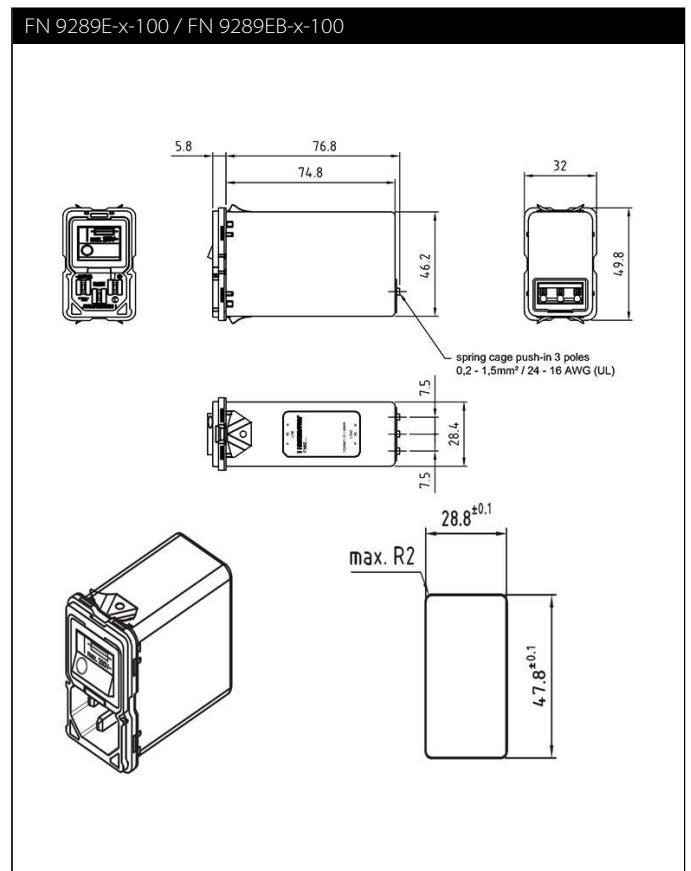
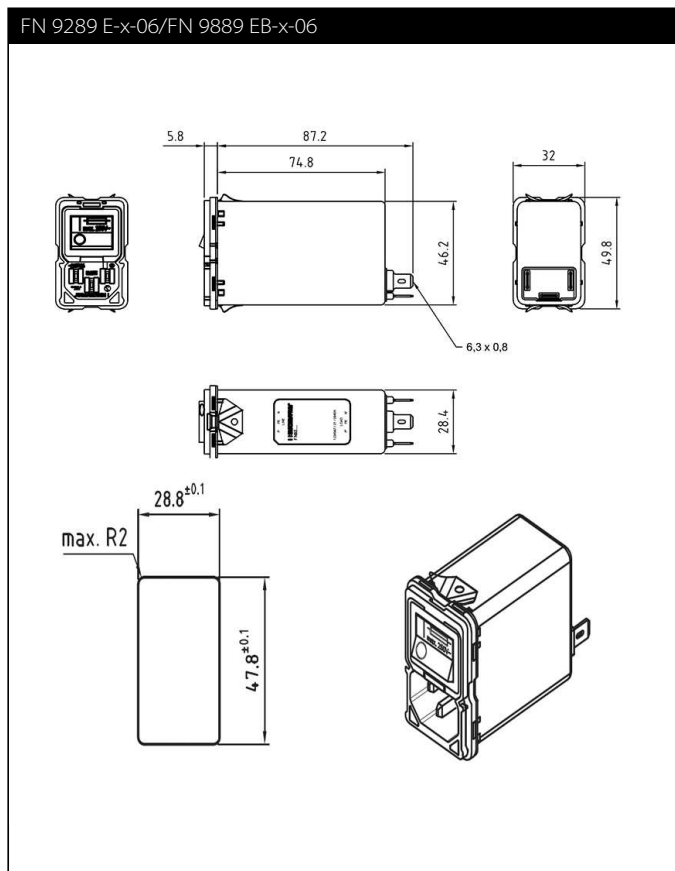
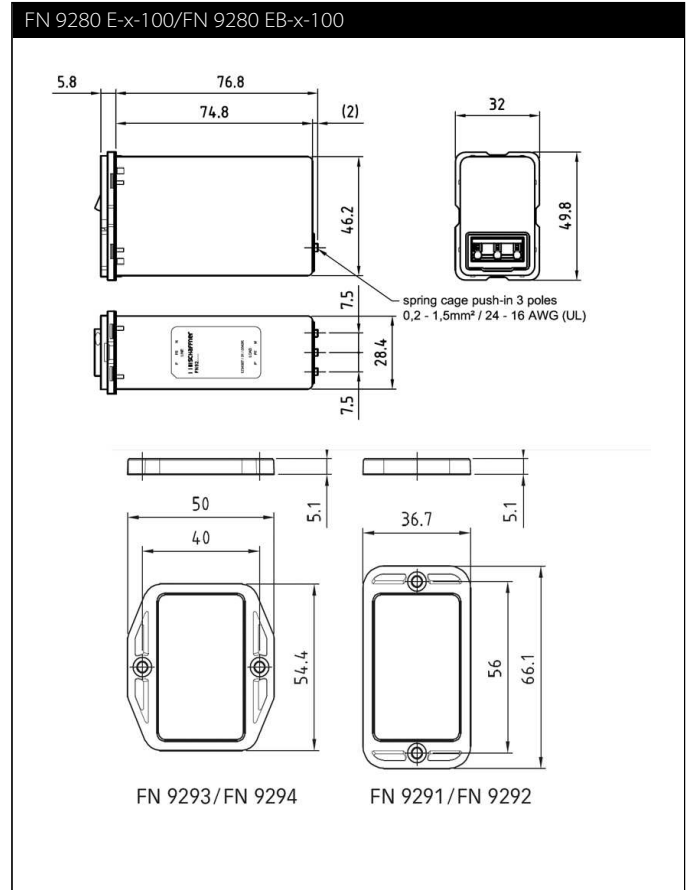
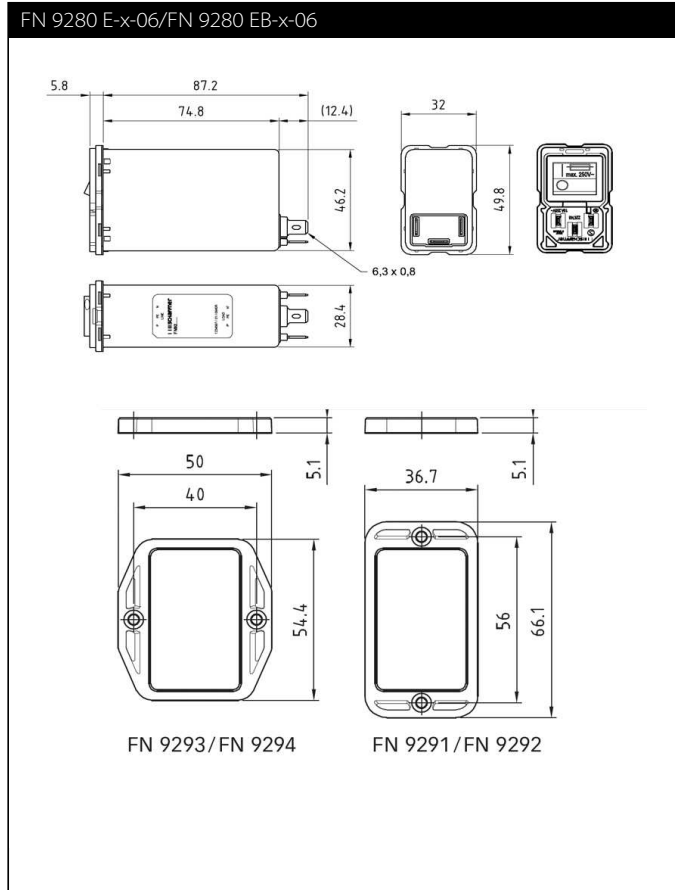

Assembly Instructions

REAR MOUNTING

vertical:

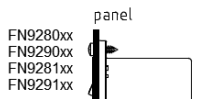

FN9280xx
FN9290xx
FN9281xx
FN9291xx

Cutout:

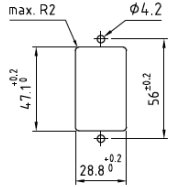

Assembly:

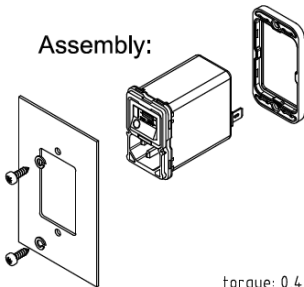

torque: 0,4Nm

horizontal:

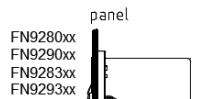

FN9280xx
FN9290xx
FN9283xx
FN9293xx

Cutout:

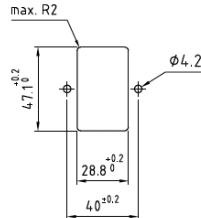

Assembly:

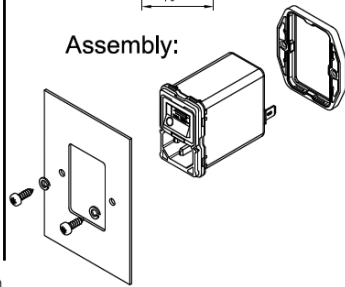

FRONT MOUNTING

vertical:

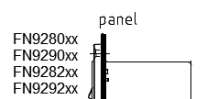

FN9280xx
FN9290xx
FN9282xx
FN9292xx

Cutout:

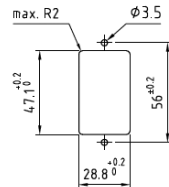

Assembly:

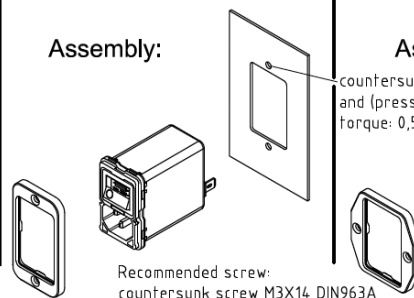

Recommended screw:
countersunk screw M3X14 DIN963A

horizontal:

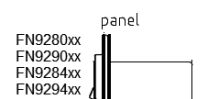

FN9280xx
FN9290xx
FN9284xx
FN9294xx

Cutout:

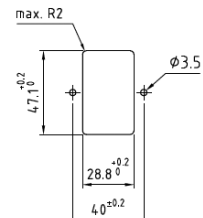

Assembly:

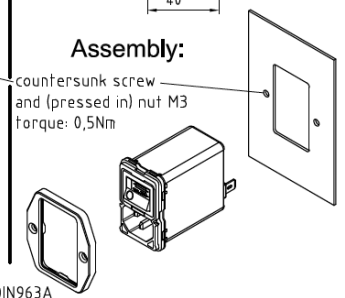

countersunk screw
and (pressed in) nut M3
torque: 0,5Nm

Terminal -100

clamping range, solid wire / flex wire

0,20 mm² – 1,5 mm², AWG24 – AWG16

operating force of slider

max. 40 N

recommended stripped length

8 mm

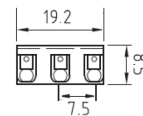

Push the knob above the terminal to insert the wire.

Removal of the combined switch / fuse holder unit

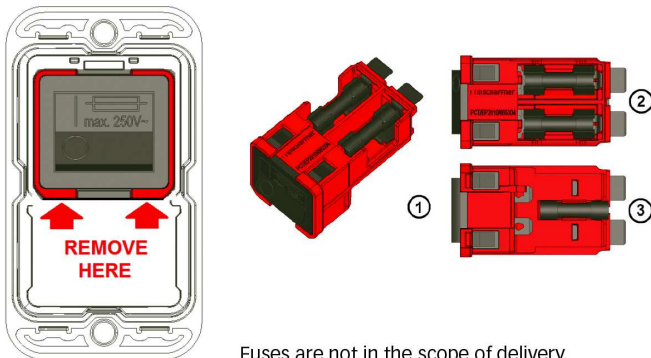

Fuses are not in the scope of delivery.

An additional fuse mark on the switch indicates the fuses holders behind the switch. The red frame shows the outline of the removable unit.

With a simple tool like a Swiss Army knife or a screwdriver No 1 or smaller the unit (1) can be removed from the filter. On the topside (2) behind the switch there are two fuse holders for each live connection. On the bottom side (3) is a clip to carry an additional spare fuse.

Please visit www.schaffner.com to find more details on filter connectors.



Headquarters, global innovation and development

Switzerland

Schaffner Group

Nordstrasse 11
4542 Luterbach
T +41 32 681 66 26
F +41 32 681 66 30
info@schaffner.com
<http://www.schaffner.com>



Sales and application centers

China

Schaffner EMC Ltd. Shanghai

T20-3 C, No 565 Chuangye Road,
Pudong district
201201 Shanghai
T +86 21 3813 9500
cschina@schaffner.com
<http://www.schaffner.com.cn>

Finland

Schaffner Oy

Sauvonrinne 19 H
08500 Lohja
T +358 50 468 7284
finlandsales@schaffner.com

France

Schaffner EMC S.A.S.

112 Quai de Bezons
95100 Argenteuil
T +33 1 34 34 30 60
F +33 1 39 47 02 28
francesales@schaffner.com

Germany

Schaffner Deutschland GmbH

Schoemperlenstrasse 12B
76185 Karlsruhe
T +49 721 56910
F +49 721 569110
germanysales@schaffner.com

India

Schaffner India Pvt. Ltd

Unit 59, Level, Mfar Greenheart 7
Manyata Tech Park, Hebbal Outer Ring Road
560045 Bangalore
T +91 80 6781 9805
F +91 80 6781 9998
indiasales@schaffner.com

Italy

Schaffner EMC S.r.l.

Via Galileo Galilei 47
20092 Cinisello Balsamo (MI)
T +39 02 66 04 30 45 /47
F +39 02 61 23 943
italysales@schaffner.com

Japan

Schaffner EMC K.K.

1-32-12, Kamiyama, Setagaya-ku
7F Mitsui-seimei Sangenjaya Bldg.
154-0011 Tokyo
T +81 3 5712 3650
F +81 3 5712 3651
japansales@schaffner.com
<http://www.schaffner.jp>

Singapore

Schaffner EMC Pte Ltd.

#05-09, Kg Ubi Ind. Estate
408705 Singapore
T +65 6377 3283
F +65 6377 3281
singaporesales@schaffner.com

Spain

Schaffner EMC España

Calle Caléndula 93, Miniparc III, Edificio E
El Soto de Moraleja, Alcobendas
28109 Madrid
T +34 917 912 900
F +34 917 912 901
spainsales@schaffner.com

Sweden

Schaffner EMC AB

Tegeluddsvägen 76, 2tr
115 28 Stockholm
T +46 8 5050 2425
swedensales@schaffner.com
<http://www.schaffner.com>

Switzerland

Schaffner EMV AG

Nordstrasse 11
4542 Luterbach
T +41 32 681 66 26
switzerlandsales@schaffner.com

Taiwan R.O.C.

Schaffner EMV Ltd.

20 Floor-2, No 97, Section 1, XinTai 5th Road
22175 XiZhi District New Taipei City 22175
T +886 2 2697 5500
F +886 2 2697 5533
taiwansales@schaffner.com
<http://www.schaffner.tw>

Thailand

Schaffner EMC Co. Ltd.

Northern Region Industrial Estate
67 Moo 4 Tambon Ban Klang
Amphur Muangng P.O. Box 14
51000 Lamphun
T +66 53 58 11 04
F +66 53 58 10 19
thailandsales@schaffner.com

United Kingdom

Schaffner Ltd.

5 Ashville Way, Molly Millars Lane
Wokingham
RG41 2PL Berkshire
T +44 118 9770070
F +44 118 9792969
uksales@schaffner.com

USA

Schaffner EMC Inc.

52 Mayfield Avenue
08837 Edison, New Jersey
T +1 800 367 5566
T +1 732 225 9533
F +1 732 225 4789
usasales@schaffner.com
<http://www.schaffnerusa.com>

Schaffner North America

6722 Thirlane Road
24019 Roanoke, Virginia
T +1 276 228 7943
F +1 276 228 7953

Schaffner North America

823 Fairview Road
24382 Wytheville, Virginia
T +1 276 228 7943
F +1 276 228 7258

To find your local partner within Schaffner's global network: www.schaffner.com

© 2016 Schaffner Group

The content of this document has been carefully checked and understood. However, neither Schaffner nor its subsidiaries assume any liability whatsoever for any errors or inaccuracies of this document and the consequences thereof. Published specifications are subject to change without notice. Product suitability for any area of application must ultimately be determined by the customer. In all cases, products must never be operated outside their published specifications. Schaffner does not guarantee the availability of all published products. This disclaimer shall be governed by substantive Swiss law and resulting disputes shall be settled by the courts at the place of business of Schaffner Holding AG. Latest publications and a complete disclaimer can be downloaded from the Schaffner website. All trademarks recognized.