







# Air Cylinder

# Series CG1

ø20, ø25, ø32, ø40, ø50, ø63, ø80, ø100

## Variations

Series	Action	Rod	Cushion	Basic	Variation					Bore size (mm)	Page
					With One-touch fitting	With rod boot	Air-hydro	Clean series	Copper free		
<b>Standard/Series CG1</b> 	Double acting	Single rod	Rubber Air	●	●	●	●	●	20 to 100	1.7-2 1.7-14	
		Double rod	Rubber Air	●	●	●	●	●			
<b>Standard/Series CG1</b> 	Single acting	Single rod (Spring return) (Spring extend)	Rubber	●					20 to 40	1.7-20	
<b>Non-rotating rod Series CG1K</b> 	Double acting	Single rod	Rubber Air	●				●	20 to 63 40 to 63	1.7-26	
		Double rod	Rubber	●					20 to 63		1.7-30
		<b>Direct mount Series CG1R</b> 	Double acting	Single rod	Rubber Air	●			●	●	20 to 63
<b>Direct mount/Non-rotating rod Series CG1KR</b> 	Double acting	Single rod	Rubber	●					20 to 63	1.7-40	
<b>Low friction Series CG1□Q</b> 	Double acting	Single rod	No cushion (ø20 to ø63) Rubber (ø80, ø100)	●					20 to 100	1.7-43	

CG1

CG1

CG1

CG1

CG1

CG1

CG1

CG1

CG1

CG1

CG1

CG1

CG1

CG1

CG1

## Applicable auto switch

Auto switch model	Band mounting
<b>Reed switch</b>	D-C7/8, D-C73C/C80C D-B5/B6, D-B59W
<b>Solid state switch</b>	D-H7□, D-H7□W, D-H7□F D-H7BAL, D-H7C, D-G5/K5 D-G5□W/K59W, D-G59F, D-G5NTL

## Made to Order

Refer to p.5.4-1 for made to order products of series CG1

# Standard: Double Acting Single Rod

# Series CG1

ø20, ø25, ø32, ø40, ø50, ø63, ø80, ø100

## How to Order

**Standard**

CG1 L N 25 100

**With auto switch**

CDG1 L N 25 100 B53

**With auto switch (magnet)**

**Mounting**

B	Basic
L	Axial foot
F	Front flange
G	Rear flange
U*	Front trunnion
T*	Rear trunnion
D	Clevis

\* Not available for bore sizes ø80 and ø100.  
\*\* Mounting brackets are included, not mounted.

**Number of auto switches**

—	2
S	1
n	n

**Auto switch**

—	Without auto switch (Built-in magnet)
---	---------------------------------------

\* Refer to the table below for selecting applicable auto switches.

**Rod boot (at one side)**

—	Without rod boot
J	Nylon tarpaulin
K	Heat resistant tarpaulin

\* Foot brackets and front flanges are fitted when rod boots are mounted.

**Bore size**

20	20mm	50	50mm
25	25mm	63	63mm
32	32mm	80	80mm
40	40mm	100	100mm

**Cylinder stroke (mm)**

Refer to p.1.7-3 for Standard Stroke Table.

**Cushion**

N	Rubber bumper
A	Air cushion

### Applicable Auto Switches/Refer to p.5.3-2 for further information on auto switch.

Style	Special function	Electrical entry	Indicator	Wiring (Output)	Load voltage		Auto switch model		Lead wire (m)*				Applicable load													
					DC	AC	Applicable bore size		0.5 (-)	3 (L)	5 (Z)	None (N)														
							ø20 to ø63	ø20 to ø100																		
Reed switch	—	Grommet	Yes	3 wire (NPN)	—	5V	—	C76	—	●	●	—	—	IC	Relay PLC											
								—	B53	●	●	●	—	—		PLC										
				2 wire	24V	12V	200V or less	—	B54	●	●	●	—	—		—										
								—	B64	●	●	—	—	—												
		Connector	No	5V, 12V	100V or less	C80	—	●	●	—	—	—	—	—		IC										
																	12V	—	C73C	—	●	●	●	●	—	—
																			5V, 12V	24V or less	C80C	—	●	●	●	●
Diagnostic indication (2 color)	Grommet	Yes	—	—	—	—	B59W	—	●	●	—	—	—													
Solid state switch	—	Grommet	Yes	3 wire (NPN)	5V, 12V	—	—	H7A1	G59	●	●	○	—	IC	Relay PLC											
				3 wire (PNP)				H7A2	G5P	●	●	○	—	—												
		Connector	2 wire	12V	—	H7B	K59	●	●	○	—	—														
						H7C	—	●	●	●	●	—	—													
	Diagnostic indication (2 color)	Grommet	Yes	3 wire (NPN)	5V, 12V	—	—	H7NW	G59W	●	●	○	—	IC												
				3 wire (PNP)				H7PW	G5PW	●	●	○	—	—												
				2 wire				H7BW	K59W	●	●	○	—	—												
	Water resistant (2 color)	Grommet	No	2 wire	12V	—	—	H7BA	G5BA	—	●	○	—	—												
								—	G5NT	—	●	○	—	—		IC										
	With timer	Grommet	Yes	3 wire (NPN)	5V, 12V	—	—	H7NF	G59F	●	●	○	—	—												
	Diagnostic output (2 color)			—				H7LF	—	●	●	○	—	—												
Latch with diagnostic output (2 color)	Grommet	Yes	4 wire (NPN)	—	—	—	—	—	●	●	○	—	—													

\* Lead wire length 0.5m.....— 3m.....L e.g.) C73C 5m.....Z None.....N e.g.) C73CZ C73CN

\* Solid state switches marked with "○" are manufactured upon receipt of order.

# Standard: Double Acting Single Rod *Series CG1*

## Substantially shorter length:

- ø20 to ø40: -15 to -30mm  
(in comparison with CM2 Series)
- ø40 to ø63: -17 to -28mm  
(in comparison with CA1 Series)
- ø80 to ø100: -9 to -33mm  
(in comparison with CA1 Series)

**High speed operation: 1000mm/s**  
(ø80 and ø100 operate at 700mm/s)

## Provided with an air cushion as standard

Two cushions are available:  
an air cushion or rubber bumper

**Weight reduction of 10 to 50%**  
(50mm stroke, in-house comparison)

## Highly accurate mounting brackets

(Axial foot, front flange)



Standard stroke

## JIS symbol

Double acting

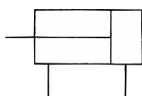

## Order Made Made to Order

Refer to p.5.4-1 for made to order products of series CG1.

## Mounting Bracket

Refer to p.1.7-4 for part numbers for the mounting brackets.

## Auto Switch Mounting Band

Refer to p.1.7-4 for part numbers for the mounting bands.

## Specifications

Bore size (mm)	20	25	32	40	50	63	80	100
Action	Double acting/Single rod							
Lubrication	Non-lube							
Fluid	Air							
Proof pressure	1.5MPa							
Max. operating pressure	1.0MPa							
Min. operating pressure	0.05MPa							
Ambient and fluid temperature	Without auto switch: -10 to +70°C (No freezing)							
	With auto switch: -10 to +60°C (No freezing)							
Piston speed	50 to 1000mm/s						50 to 700mm/s	
Stroke tolerance	Up to 1000 <sup>+1.4</sup> <sub>0</sub> mm, Up to 1200 <sup>+1.8</sup> <sub>0</sub> mm						Up to 1000 <sup>+1.4</sup> <sub>0</sub> mm Up to 1500 <sup>+1.8</sup> <sub>0</sub> mm	
Thread tolerance	JIS class 2							
Cushion	Rubber bumper/Air cushion							
Mounting*	Basic, Axial foot, Front flange, Rear flange, Front trunnion, Rear trunnion, Clevis (Used for changing the port location by 90° degrees.)							



Front/Rear trunnion styles are not available for bore sizes ø80 and ø100.

## Accessories

Mounting		Basic	Axial foot	Front flange	Rear flange	Front trunnion	Rear trunnion	Clevis
Standard	Rod end nut	●	●	●	●	●	●	●
	Clevis pin	—	—	—	—	—	—	●
Option	Single knuckle joint	●	●	●	●	●	●	●
	Double knuckle joint** (With pins)	●	●	●	●	●	●	●
	Pivot bracket	—	—	—	—	●*	●*	●
	Rod boot	●	●	●	●	●	●	●

\* Pivot bracket is not available for bore sizes ø80 and ø100.

\*\* Pins and snap rings for double knuckle joint are included, not mounted.

## Stroke

Bore size (mm)	Standard stroke (1) (mm)	Long stroke (2) (mm)	Max stroke (mm)
20	25, 50, 75, 100, 125, 150, 200	201 to 350	1500
25		301 to 400	
32		301 to 450	
40	25, 50, 75, 100, 125, 150, 200, 250, 300	301 to 800	
50/63		301 to 1200	
80		301 to 1400	
100		301 to 1500	



Note 1) Other intermediate strokes can be manufactured upon receipt of order. Spacers are not used for the intermediate strokes. Refer to p.1.7-8 to 1.7-10 for dimensions.

Note 2) Long stroke applies to the axial foot and the front flange style. If other mounting brackets are used or the length exceeds the stroke limit, the stroke should be determined based on the stroke selection table in the technical data.

## Minimum Strokes for Auto Switch Mounting

Auto switch model	Number of switches	
	2	1
D-C7/C8 D-B5/B6 D-H7 D-G5/K5	15mm	10mm
D-B59W	20mm	15mm
D-H7LF	20mm	10mm

## Rod Boot Materials

Symbol	Material	Max. operating temp
J	Nylon tarpaulin	70°C
K	Heat resistant tarpaulin	110°C*

\* Maximum ambient temperature for the rod boot only.

CJ1

CJP

CJ2

CM2

C85

C76

CG1

MB

MB1

CP95

C95

C92

CA1

CS1

# Series CG1

## Mounting Bracket Part No.

Mounting bracket	Bore size (mm)							
	20	25	32	40	50	63	80	100
Axial foot*	CG-L020	CG-L025	CG-L032	CG-L040	CG-L050	CG-L063	CG-L080	CG-L100
Flange	CG-F020	CG-F025	CG-F032	CG-F040	CG-F050	CG-F063	CG-F080	CG-F100
Trunnion	CG-T020	CG-T025	CG-T032	CG-T040	CG-T050	CG-T063	—	—
Clevis**	CG-D020	CG-D025	CG-D032	CG-D040	CG-D050	CG-D063	CG-D080	CG-D100
Pivot bracket	CG-Q20-24A	CG-Q25-24A	CG-Q32-24A	CG-Q40-24A	CG-Q50-24A	CG-Q63-24A	CG-Q80-24A	CG-Q100-24A

\* Order two foot brackets per a cylinder.

\*\* Clevis pins, snap rings and mounting bolts are attached for the clevis.

\*\*\* Mounting bolts are attached for the foot type and the flange type.

## Auto Switch Mounting Bracket Part No.

Auto switch model	Bore size (mm)							
	20	25	32	40	50	63	80	100
D-C7/C8	BMA2-020	BMA2-025	BMA2-032	BMA2-040	BMA2-050	BMA2-063	—	—
D-H7								
D-B5/B6	BA-01	BA-02	BA-32	BA-04	BA-05	BA-06	BA-08	BA-10
D-G5/K5								

\* A set of following stainless steel mounting screws is attached.  
(A switch mounting band is not attached. Please order the band separately.)

BBA3: D-B5/B6/G5 types

BBA4: D-C7/C8/H7 types

• "D-G5BAL" and "D-H7BAL" switches are set on the cylinder with the screws above when shipped.

When a switch only is shipped, "BBA3" or "BBA4" screws are attached.

## Weight

Bore size (mm)		20	25	32	40	50	63	80	100
Basic weight	Basic	0.10	0.17	0.26	0.41	0.77	1.07	2.04	3.17
	Axial foot	0.21	0.30	0.42	0.63	1.25	1.79	3.00	4.92
	Flange	0.18	0.27	0.40	0.61	1.11	1.57	2.75	4.52
	Trunnion	0.11	0.19	0.29	0.46	0.91	1.21	—	—
	Clevis	0.15	0.25	0.41	0.64	1.17	1.75	2.75	4.45
Pivot bracket		0.08	0.09	0.17	0.25	0.44	0.80	0.98	1.75
Single knuckle joint		0.05	0.09	0.09	0.10	0.22	0.22	0.39	0.57
Double knuckle joint (with pins)		0.05	0.09	0.09	0.13	0.26	0.26	0.64	1.31
Additional weight by each 50 stroke		0.05	0.07	0.09	0.15	0.22	0.26	0.35	0.49
Additional weight by air cushion		0.01	0.01	0.02	0.02	0.03	0.03	0.03	0.03
Additional weight by long stroke		0.01	0.01	0.02	0.03	0.06	0.10	0.19	0.26

Calculation example: **CG1LA20-100**  
(Foot, ø20, 100 stroke)

- Basic weight.....0.21 (Foot, ø20)
  - Additional weight.....0.05/50 stroke
  - Cylinder stroke.....100 stroke
  - Additional weight by air cushion...0.01kg
- $0.21+0.05 \times 100/50+0.01=0.32\text{kg}$

## Mounting Procedures

### Trunnion

Follow the procedures below when mounting a pivot bracket on the trunnion.

ø20 to ø63

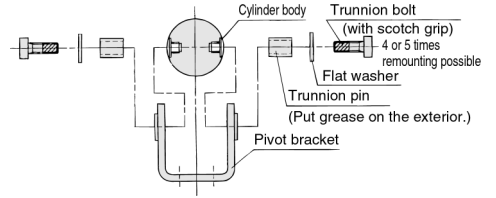

### Clevis

Follow the procedures below when mounting a pivot bracket on the clevis.

ø20 to ø63

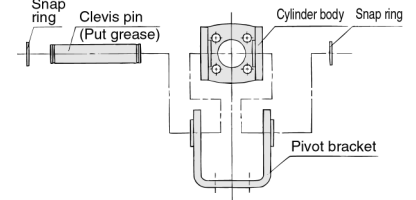

ø80, ø100

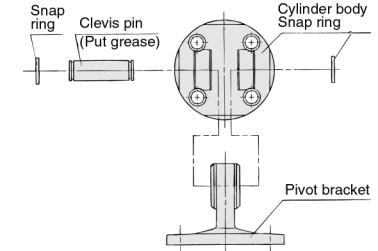

# Standard: Double Acting Single Rod *Series CG1*

## Built-in One-touch Fitting

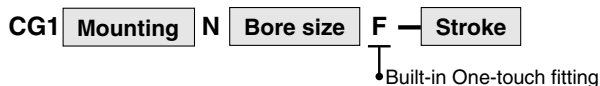

A style in which One-touch fittings are built into the cylinder. It dramatically reduces the piping labour and installation space.

### Specifications

Bore size (mm)	ø20, ø25, ø32, ø40, ø50, ø63
Action	Double acting/Single rod
Fluid	Air
Max. operating pressure	1.0MPa
Min. operating pressure	0.05MPa
Piston speed	50 to 750mm/s
Cushion	Rubber bumper
Mounting	Basic, Axial foot, Front flange, Rear flange, Front trunnion, Rear trunnion, Clevis (Used for changing the port location by 90° degrees.)

### Applicable Tube O.D./I.D.

\* Auto switch can be mounted.

Bore size (mm)	ø20	ø25	ø32	ø40	ø50	ø63
Applicable tube (mm)	ø6/4	ø6/4	ø6/4	ø8/6	ø10/7.5	ø10/7.5
Applicable tube material	Nylon, Soft nylon, Polyurethane					

\* Refer to p.1.7-3 for other specifications.

## Clean Series

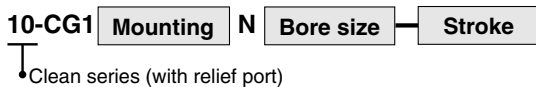

The rod portion of the actuator has a double seal construction, and a relief port is provided to discharge the exhaust air directly outside of the clean room. Thus, it is a style that can be used in a Class 100 clean room.

### Specifications

Bore size (mm)	ø20, ø25, ø32, ø40, ø50, ø63, ø80, ø100
Action	Double acting/Single rod
Fluid	Air
Max. operating pressure	1.0MPa
Min. operating pressure	0.05MPa
Cushion	Rubber bumper
Piston speed	50 to 400mm/s
Relief port size	M5
Mounting	Basic, Axial foot, Front flange, Rear flange

\* Auto switch can be mounted.

## Air-hydro

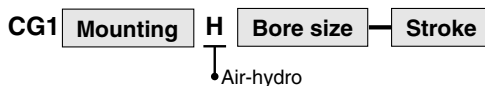

A low hydraulic pressure cylinder used at a pressure of 1.0MPa or below. Through the concurrent use of a CC series air-hydro unit, it is possible to operate at a constant or low speed or to effect an intermediate stop, just like a hydraulic unit, while using pneumatic equipment such as a valve.

### Specifications

Style	Air-hydro Cylinder
Bore size (mm)	ø20, ø25, ø32, ø40, ø50, ø63
Action	Double acting/Single rod
Fluid	Turbine oil
Proof pressure	1.5MPa
Max. operating pressure	1.0MPa
Min. operating pressure	0.18MPa
Piston speed	15 to 300mm/s
Cushion	None
Ambient and fluid temperature	+5 to 60°C
Thread tolerance	JIS class 2
Stroke tolerance	Up to 1000 <sup>+1.4</sup> <sub>0</sub> mm, Up to 1200 <sup>+1.8</sup> <sub>0</sub> mm
Mounting	Basic, Axial foot, Front flange, Rear flange, Front trunnion, Rear trunnion, Clevis (Used for changing the port location by 90° degrees.)

\* Auto switch can be mounted.

## Copper Free

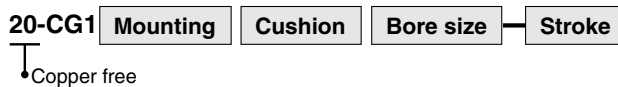

This cylinder eliminates any influences of copper ions or fluororesins on colour CRTs. Copper materials have been nickel plated or replaced with non-copper materials to prevent the generation of copper ions.

### Specifications

Bore size (mm)	ø20, ø25, ø32, ø40, ø50, ø63, ø80, ø100	
Action	Double acting/Single rod	
Fluid	Air	
Max. operating pressure	1.0MPa	
Min. operating pressure	0.05MPa	
Cushion	N	Rubber bumper
	A	Air cushion
Piston speed	ø20 to 63	50 to 1000mm/s
	ø80/100	50 to 700mm/s
Mounting*	Basic, Axial foot, Front flange, Rear flange, Front trunnion, Rear trunnion, Clevis (Used for changing the port location by 90° degrees.)	

\* Front/Rear trunnion styles are not available for bore sizes ø80 and ø100. Refer to p.1.7-8 for dimensions.

\* Auto switch can be mounted.

CJ1

CJP

CJ2

CM2

C85

C76

CG1

MB

MB1

CP95

C95

C92

CA1

CS1

# Series CG1

## Water Resistant

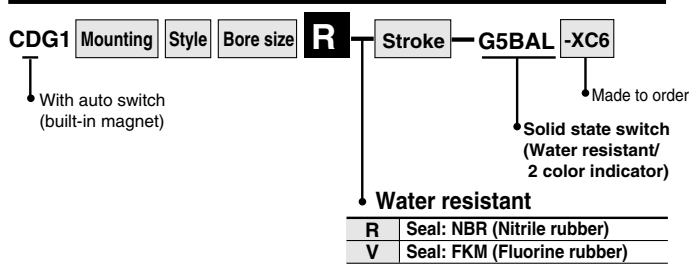

Ideal for use in a machine tool environment exposed to coolant mist. Also suited for use in areas in which water splashes, such as food processing equipment or car washers.

### Specifications

Action	Double acting/Single rod
Bore size (mm)	ø32, ø40, ø50, ø63, ø80, ø100
Cushion	Rubber bumper/Air cushion
Auto switch mounting method	Band mounting
Made to order	Material of the piston rod and rod end nut is stainless steel. (-XC6)

\* Other specifications are the same as the standard model.

### Dimensions

#### Rubber bumper

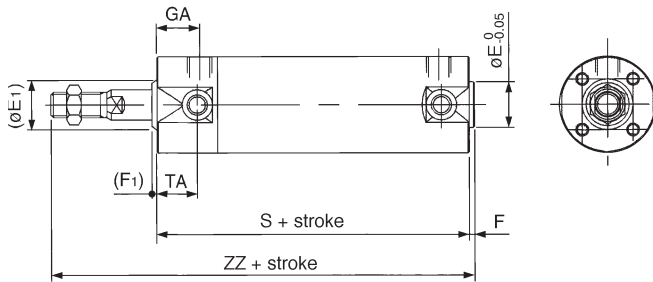

#### Air cushion

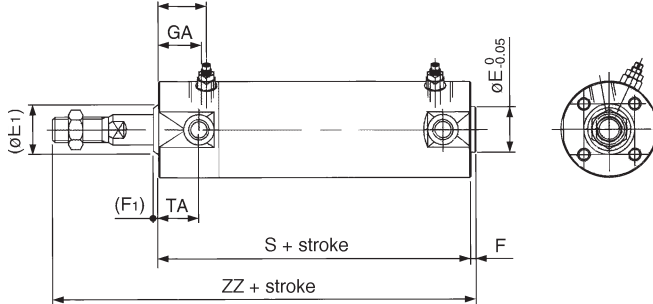

(mm)

Bore (mm)	(E1)	E*	(F1)	F*	GA	S	TA	WA	ZZ
32	17	18	2	2	18	77 (85)	17	20	119 (127)
40	21	25	2	2	19	84 (93)	18	21	136 (145)
50	26	30	2	2	21	97 (109)	20	23	157 (169)
63	26	32	2	2	21	97 (109)	20	23	157 (169)
80	32	40	3	3	28	116 (130)	—	30	190 (204)
100	37	50	3	3	29	117 (131)	—	31	191 (205)

\* These dimensions and other dimensions not indicated here are the same as standard.  
Note) ( ): Long stroke

## ⚠ Precautions

Be sure to read before handling.  
Refer to p.0-39 to 0-46 for Safety Instructions and common precautions.

### Precautions on handling

#### ⚠ Warning

- Do not operate the cushion valve in the fully closed or fully opened state.
  - Using it in the fully closed state will cause the cushion seal to be damaged. Using it in the fully opened state will cause the piston rod assembly or the cover to be damaged.
- Operate within the specified cylinder speed.
  - Failure to do so will damage the cylinder and the seals.

#### ⚠ Caution

- Do not use the air cylinder as an air-hydro cylinder. This will cause an oil leak.
- Install without twisting the bellows.
  - If the cylinder is installed with its bellows twisted, it could damage the bellows.

### Disassembly/Replacement

#### ⚠ Caution

- Do not replace the bushings or the cushion seals.
  - The bushings and the cushion seals are press-fit. To replace them, they must be replaced together with the cover assembly.
- To replace a seal, apply grease to the new seal before installing it.
  - If the cylinder is put into operation without applying grease to the seal, it could cause the seal to wear significantly, leading to premature air leakage.
- Do not replace One-touch fittings.
  - Because pipe fittings are press-fit, they must be replaced together with the cover assembly.
- Those with a bore of ø50 or more cannot be disassembled.
  - When disassembling a cylinder with a bore of ø20 to ø40, use a vise or the like to hold the wrench flats portion of the tube cover or the rod cover on one side, while placing a wrench or an adjustable wrench on the other side to loosen and remove the cover. To replace, tighten it an additional 2... from the installed position. (Those with a bore of ø50 or more cannot be disassembled because they have been tightened with greater torque. If they must be disassembled, contact SMC.)

# Standard: Double Acting Single Rod *Series CG1*

## Construction

### With rubber bumper

ø80, ø100

ø80, ø100

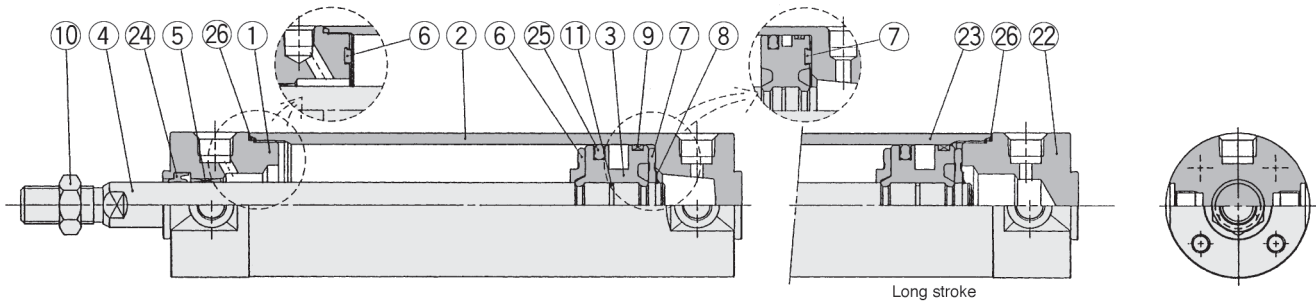

### With air cushion

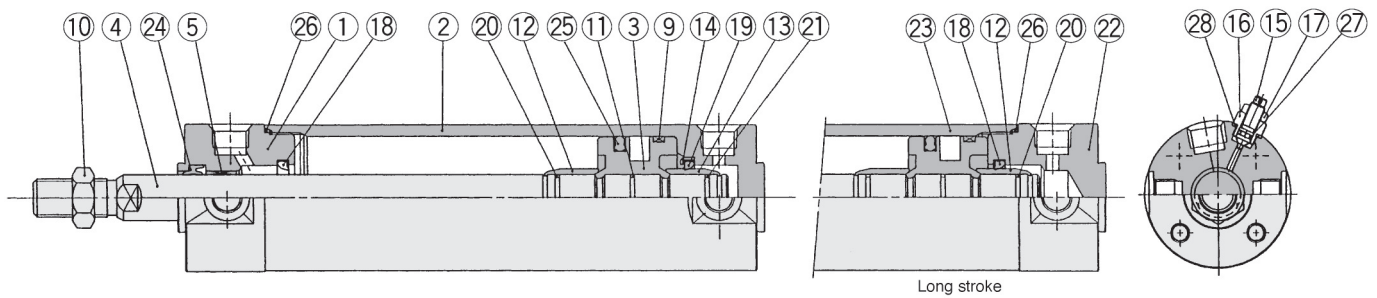

CJ1

CJP

CJ2

CM2

C85

C76

**CG1**

MB

MB1

CP95

C95

C92

CA1

CS1

### Component Parts

No.	Description	Material	Note
①	Rod cover	Aluminum alloy	White hard anodized
②	Tube cover	Aluminum alloy	White hard anodized
③	Piston	Aluminum alloy	Chromated
④	Piston rod	Carbon steel	Hard chrome plated
⑤	Bushing	Oil impregnated sintered alloy	ø40 or larger: Lead bronze cast
⑥	Bumper A	Urethane	
⑦	Bumper B	Urethane	ø40 or larger: the same as damper A
⑧	Snap ring	Stainless steel	Except for ø80 and ø100
⑨	Wear ring	Resin	
⑩	Rod end nut	Rolled steel	Nickel plated
⑪	Piston gasket	NBR	
⑫	Cushion ring A	Brass	
⑬	Cushion ring B	Brass	ø32 or more: the same as A
⑭	Seal retainer	Rolled steel	Nickel plated/Except for long stroke
⑮	Cushion valve	Rolled steel	Electroless nickel plated
⑯	Valve retainer	Rolled steel	Electroless nickel plated
⑰	Lock nut	Rolled steel	Nickel plated
⑱	Cushion seal A	Urethane	
⑲	Cushion seal B	Urethane	ø32 or larger: the same as A *
⑳	Cushion ring gasket A	NBR	
㉑	Cushion ring gasket B	NBR	ø32 or larger: the same as A
㉒	Head cover	Aluminum alloy	White hard anodized
㉓	Cylinder tube	Aluminum alloy	Hard anodized

Note) A magnet is equipped on the piston of the cylinder with auto switch.

\* The material is stainless steel on auto switch equipped styles ø20 and ø25.

### Replacement Parts/With rubber bumper

No.	Description	Material	Bore size (mm)/Part No.							
			ø20	ø25	ø32	ø40	ø50	ø63	ø80	ø100
㉔	Rod seal	NBR	PDU-8Z	PDU-10Z	PDU-12LZ	PDU-16Z	PDU-20Z	PDU-20Z	PDU-25Z	PDU-30Z
㉕	Piston seal	NBR	PPD-20	PPD-25-19	PPD-32	PPD-40	PPD-50	PPD-63	PPD-80	PPD-100
㉖	Tube gasket	NBR	CM-020-16-123	CM-025-16-124	CM-032-16-126	CM-040-16-127	CM-050-16-128	CM-063-16-129	CM-080-16-152	CM-100-16-153

With air cushion (Parts ㉔ to ㉖ are the same as rubber bumper style.)

㉗	Valve seal	NBR		O ring ø4.5 X ø2.5 X ø1		O ring ø5.5 X ø3.5 X ø1		O ring ø6.5 X ø4.5 X ø1
㉘	Gasket for valve retainer	NBR		O ring ø6.4 X ø5.2 X ø0.6		O ring ø7.4 X ø5.8 X ø0.8		O ring ø11.4 X ø9.4 X ø1

# Series CG1

## Basic/CG1BN: With Rubber Bumper

### TA/TB cross section

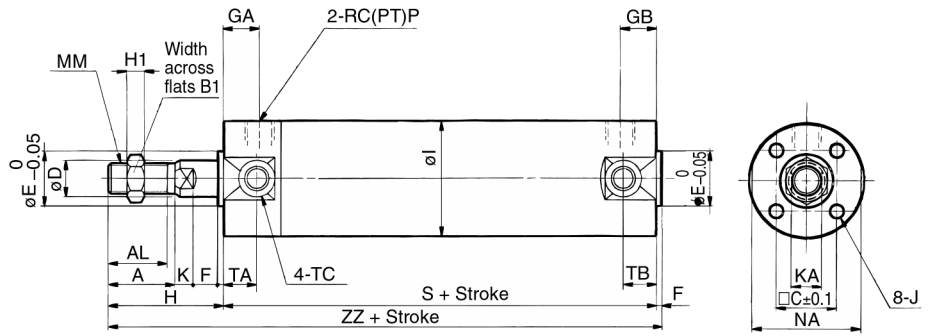
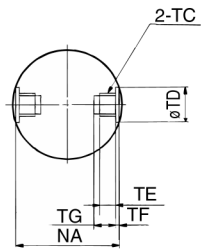

### Basic: With rod boot

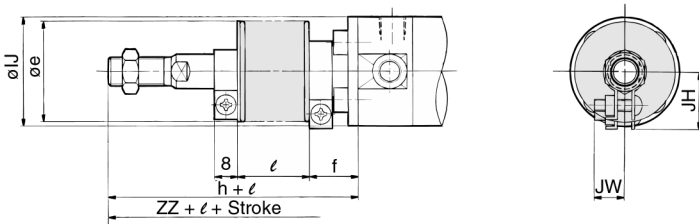

### Built-in One-touch fitting

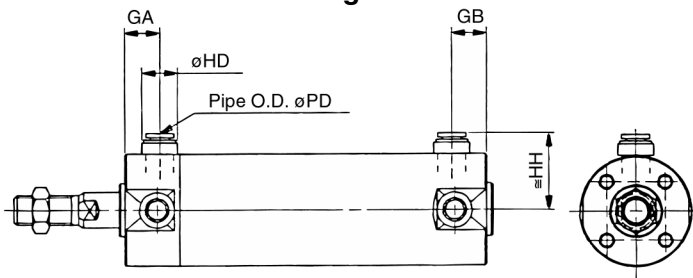

### Air-hydro

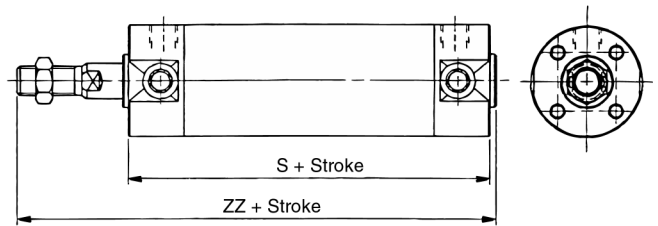

Other dimensions are the same as standard.

Other dimensions are the same as the long stroke standard.

Bore (mm)	Standard stroke (mm)	Long stroke (mm)	A	AL	B1	C	D	E	F	GA	GB	H	H1	I	J	K	KA	MM	NA	P	S	TA	TB	ZZ
20	Up to 200	201 to 350	18	15.5	13	14	8	12	2	12	12	35	5	26	M4 Depth 7	5	6	M8	24	1/8	69 (77)	11	11	106 (114)
25	Up to 300	301 to 400	22	19.5	17	16.5	10	14	2	12	10 (12)	40	6	31	M5 Depth 7.5	5.5	8	M10 X 1.25	29	1/8	69 (77)	11	11	111 (119)
32	Up to 300	301 to 450	22	19.5	17	20	12	18	2	12	10 (12)	40	6	38	M5 Depth 8	5.5	10	M10 X 1.25	35.5	1/8	71 (79)	11	10 (11)	113 (121)
40	Up to 300	301 to 800	30	27	19	26	16	25	2	13	10 (13)	50	8	47	M6 Depth 12	6	14	M14 X 1.5	44	1/8	78 (87)	12	10 (12)	130 (139)
50	Up to 300	301 to 1200	35	32	27	32	20	30	2	14	12 (14)	58	11	58	M8 Depth 16	7	18	M18 X 1.5	55	1/4	90 (102)	13	12 (13)	150 (162)
63	Up to 300	301 to 1200	35	32	27	38	20	32	2	14	12 (14)	58	11	72	M10 Depth 16	7	18	M18 X 1.5	69	1/4	90 (102)	13	12 (13)	150 (162)
80	Up to 300	301 to 1400	40	37	32	50	25	40	3	20	16 (20)	71	13	89	M10 Depth 22	10	22	M22 X 1.5	80	3/8	108 (122)	—	—	182 (196)
100	Up to 300	301 to 1500	40	37	41	60	30	50	3	20	16 (20)	71	16	110	M12 Depth 22	10	26	M26 X 1.5	100	1/2	108 (122)	—	—	182 (196)

Note 1 ( ) : Long stroke

Note 2) Trunnion mounting taps with width across flats NA are not attached for bore size 80 and 100.

### TA/TB cross section

Bore (mm)	TC*	TDH9	TE	TF	TG
20	M5	8 <sup>+0.08</sup> <sub>0</sub>	4	0.5	5.5
25	M6 X 0.75	10 <sup>+0.08</sup> <sub>0</sub>	5	1	6.5
32	M8 X 1.0	12 <sup>+0.08</sup> <sub>0</sub>	5.5	1	7.5
40	M10 X 1.25	14 <sup>+0.08</sup> <sub>0</sub>	6	1.25	8.5
50	M12 X 1.25	16 <sup>+0.08</sup> <sub>0</sub>	7.5	2	10
63	M14 X 1.5	18 <sup>+0.08</sup> <sub>0</sub>	11.5	3	14.5
80	—	—	—	—	—
100	—	—	—	—	—

### With rod boot

Bore (mm)	e	f	h	IJ	JH	JW	ℓ	ZZ
20	30	16	55	27	(14.5)	(11.5)	0.25 stroke	126 (134)
25	30	17	62	32	(17.5)	(11.5)		133 (141)
32	35	17	62	38	(19.5)	(11.5)		135 (143)
40	35	17	70	48	(22.5)	(13)		150 (159)
50	40	17	78	59	(25)	(13)		170 (182)
63	40	18	78	72	(25)	(13)		170 (182)
80	52	10	80	59	—	—	191 (205)	
100	62	7	80	71	—	—	191 (205)	

### Built-in One-touch fitting

Bore (mm)	GA	GB	HD	HH	PD
20	12	10 (12)	13	24.2	6
25	12	10 (12)	13	26.7	6
32	12	10 (12)	13	30.2	6
40	12	10 (12)	16	34.6	8
50	13	13	20	40.6	10
63	13	13	20	47.1	10

### Air-hydro

Bore (mm)	S	ZZ
20	70	107
25	70	112
32	72	114
40	80	132
50	95	155
63	95	155

\* The minimum stroke for rod boot equipped style is 20mm.

Note) ( ) : Long stroke



# Standard: Double Acting Single Rod *Series CG1*

## With Mounting Bracket

### Axial foot/CGNLN

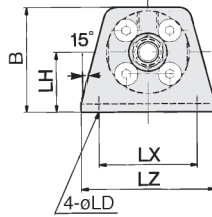
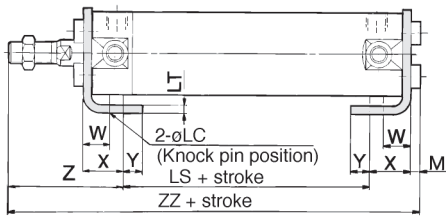

### Axial foot

Bore (mm)														Z		ZZ	
	B	LC	LD	LH	LS	LT	LX	LZ	M	W	X	Y	Without rod boot	With rod boot	Without rod boot	With rod boot	
20	34	4	6	20	45 (53)	3	32	44	3	10	15	7	47	67+ℓ	110 (118)	130 (138) +ℓ	
25	38.5	4	6	22	45 (53)	3	36	49	3.5	10	15	7	52	74+ℓ	115.5 (123.5)	137.5 (145.5) +ℓ	
32	45	4	6.6	25	45 (53)	3	44	58	3.5	10	16	8	53	75+ℓ	117.5 (125.5)	139.5 (147.5) +ℓ	
40	54.5	4	6.6	30	51 (60)	3	54	71	4	10	16.5	8.5	63.5	83.5+ℓ	135 (144)	155 (164) +ℓ	
50	70.5	5	9	40	55 (67)	4.5	66	86	5	17.5	22	11	75.5	95.5+ℓ	157.5 (169.5)	177.5 (189.5) +ℓ	
63	82.5	5	11	45	55 (67)	4.5	82	106	5	17.5	22	13	75.5	95.5+ℓ	157.5 (169.5)	177.5 (189.5) +ℓ	
80	101	6	11	55	60 (74)	4.5	100	125	5	20	28.5	14	95	104+ℓ	188.5 (202.5)	197.5 (211.5) +ℓ	
100	121	6	14	65	60 (74)	6	120	150	7	20	30	16	95	104+ℓ	192 (206)	201 (215) +ℓ	

Note 1) ( ) : Long stroke

### Front flange/CG1FN

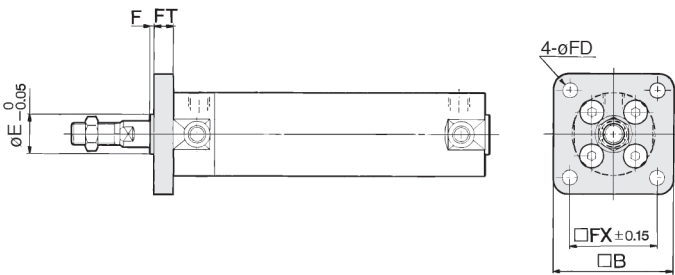

### Flange

Bore (mm)	Stroke range		B	E	F	FX	FD	FT	Rear flange ZZ	
	Front	Rear							Without rod boot	With rod boot
20	Up to 350	Up to 200	40	12	2	28	5.5	6	112	132+ℓ
25	Up to 400	Up to 300	44	14	2	32	5.5	7	118	140+ℓ
32	Up to 450	Up to 300	53	18	2	38	6.6	7	120	142+ℓ
40	Up to 800	Up to 500	61	25	2	46	6.6	8	138 (147)	158 (167) +ℓ
50	Up to 1200	Up to 600	76	30	2	58	9	9	159 (171)	179 (191) +ℓ
63	Up to 1200	Up to 600	92	32	2	70	11	9	159 (171)	179 (191) +ℓ
80	Up to 1400	Up to 750	104	40	3	82	11	11	193 (207)	202 (216) +ℓ
100	Up to 1500	Up to 750	128	50	3	100	14	14	196 (210)	202 (219) +ℓ

Note 1) ( ) : Long stroke

Note 2) End boss is machined on the flange for øE.

### Rear flange/CG1UN

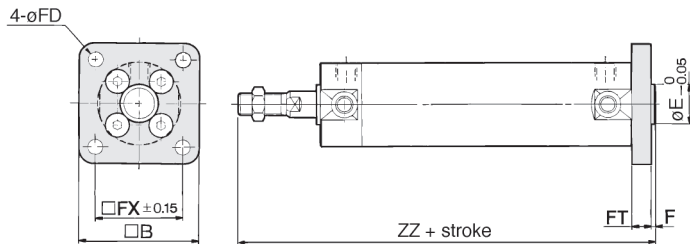

### Front trunnion/CG1UN

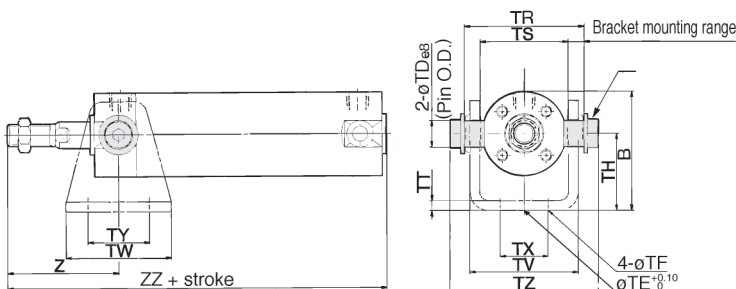

### Trunnion

Bore (mm)	Stroke range		B	TDe8	TE	TF	TH	TR	TS	TT	TV
	Front	Rear									
20	Up to 200	Up to 200	38	8 <sup>-0.025</sup> <sub>-0.047</sub>	10	5.5	25	39	28	3.2	35.8
25	Up to 300	Up to 300	45.5	10 <sup>-0.025</sup> <sub>-0.047</sub>	10	5.5	30	43	33	3.2	39.8
32	Up to 300	Up to 300	54	12 <sup>-0.032</sup> <sub>-0.059</sub>	10	6.6	35	54.5	40	4.5	49.4
40	Up to 500	Up to 500	63.5	14 <sup>-0.032</sup> <sub>-0.059</sub>	10	6.6	40	65.5	49	4.5	58.4
50	Up to 600	Up to 600	79	16 <sup>-0.032</sup> <sub>-0.059</sub>	20	9	50	80	60	6	72.4
63	Up to 600	Up to 600	96	18 <sup>-0.032</sup> <sub>-0.059</sub>	20	11	60	98	74	8	90.4

Bore (mm)	TW	TX	TY	TZ	Front Z		Rear Z		ZZ	
					Without rod boot	With rod boot	Without rod boot	With rod boot	Without rod boot	With rod boot
20	42	16	28	47.6	46	66+ℓ	93	113+ℓ	114	134+ℓ
25	42	20	28	53	51	73+ℓ	98	120+ℓ	119	141+ℓ
32	48	22	28	67.7	51	73+ℓ	101	123+ℓ	125	147+ℓ
40	56	30	30	78.7	62	82+ℓ	118 (125)	138 (145) +ℓ	146 (153)	166 (173) +ℓ
50	64	36	36	98.6	71	91+ℓ	136 (147)	156 (167) +ℓ	168 (179)	188 (199) +ℓ
63	74	46	46	119.2	71	91+ℓ	136 (147)	156 (167) +ℓ	173 (184)	193 (204) +ℓ

\* Consists of pins, flat washer and hexagon socket head cap bolt.

Note 1) ( ) : Long stroke

Note 2) Refer to p.1.7-11 for pivot bracket.

### Rear trunnion/CG1TN

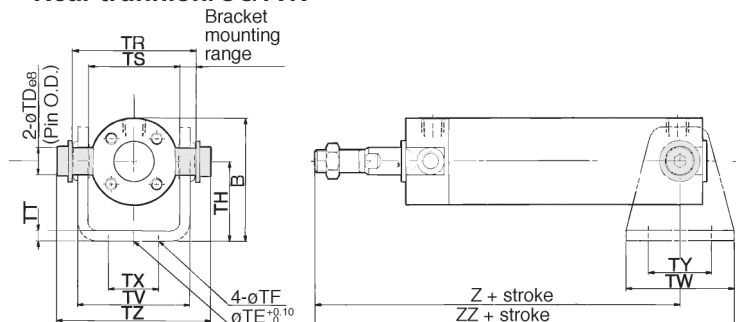

CJ1

CJP

CJ2

CM2

C85

C76

CG1

MB

MB1

CP95

C95

C92

CA1

CS1

# Series CG1

## With Mounting Bracket

### Clevis/CG1DN ø20 to ø63

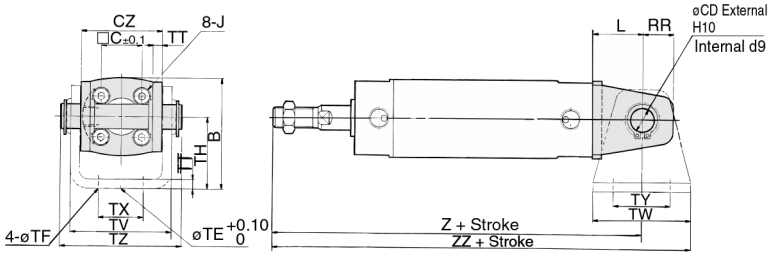

(The above shows the case port location is changed by 90° degrees.)

### ø80, ø100

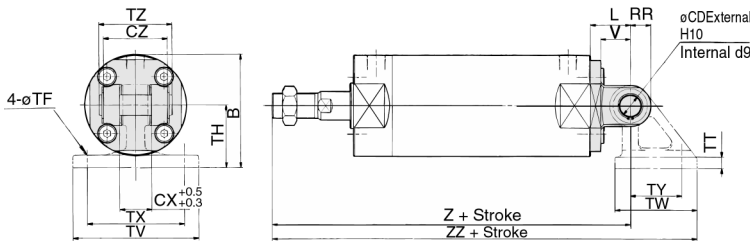

\* Clevis pins and snap rings are attached for the clevis style.

### Clevis

Bore (mm)	Stroke range (mm)	B	CD	CX	CZ	L	RR	V	TE	TF	TH
20	Up to 200	38	8	—	29	14	11	—	10	5.5	25
25	Up to 300	45.5	10	—	33	16	13	—	10	5.5	30
32	Up to 300	54	12	—	40	20	15	—	10	6.6	35
40	Up to 500	63.5	14	—	49	22	18	—	10	6.6	40
50	Up to 600	79	16	—	60	25	20	—	20	9	50
63	Up to 600	96	18	—	74	30	22	—	20	11	60
80	Up to 750	99.5	18	28	56	35	18	26	—	11	55
100	Up to 750	120	22	32	64	43	22	32	—	13.5	65

  

Bore (mm)	TT	TV	TW	TX	TY	TZ	Z	ZZ	With rod boot		Applicable pin part no.
									Z	ZZ	
20	3.2	35.8	42	16	28	43.4	118	139	138+ℓ	159+ℓ	CD-G02
25	3.2	39.8	42	20	28	48	125	146	147+ℓ	168+ℓ	CD-G25
32	4.5	49.4	48	22	28	59.4	131	155	153+ℓ	177+ℓ	CD-G03
40	4.5	58.4	56	30	30	71.4	150 (159)	178 (187)	170+ℓ (179+ℓ)	198+ℓ (207+ℓ)	CD-G04
50	6	72.4	64	36	36	86	173 (185)	205 (217)	193+ℓ (205+ℓ)	225+ℓ (237+ℓ)	CD-G05
63	8	90.4	74	46	46	105.4	178 (190)	215 (227)	198+ℓ (210+ℓ)	235+ℓ (247+ℓ)	CD-G06
80	11	110	72	85	45	64	214 (228)	272.5 (286.5)	223+ℓ (237+ℓ)	281.5+ℓ (295.5+ℓ)	IY-G08
100	12	130	93	100	60	72	222 (236)	298.5 (312.5)	231+ℓ (245+ℓ)	307.5+ℓ (321.5+ℓ)	IY-G10

Note 1) ( ): Long stroke

Note 2) Refer to p.1.7-11 for pivot bracket.

## Basic/With Air Cushion: CG1BA

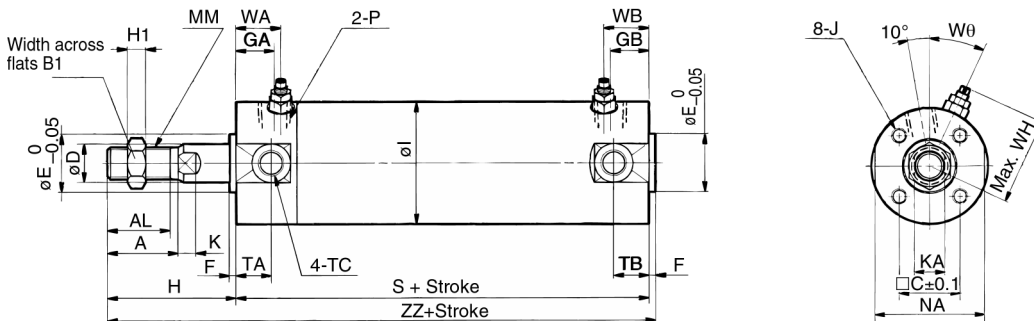

### With rod boot

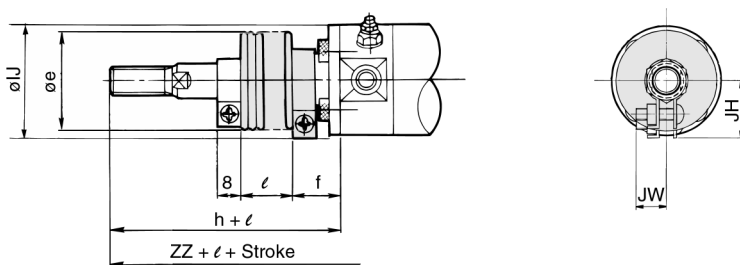

### With rod boot

Bore (mm)	e	f	h	IJ	JH	JW	ℓ	ZZ
20	30	16	55	27 (14.5)	(11.5)	—	—	126 (134)
25	30	17	62	32 (17.5)	(11.5)	—	—	133 (141)
32	35	17	62	38 (19.5)	(11.5)	—	—	135 (143)
40	35	17	70	48 (22.5)	(13)	—	—	150 (159)
50	40	17	78	59 (25)	(13)	—	—	170 (182)
63	40	18	78	72 (25)	(13)	—	—	170 (182)
80	52	10	80	59	—	—	—	191 (205)
100	62	7	80	71	—	—	—	191 (205)

\* The minimum stroke for rod boot equipped type is 20mm.

Bore (mm)	Standard stroke range (mm)	Long stroke range (mm)	A	AL	B <sub>1</sub>	C	D	E	F	GA	GB	H	H <sub>1</sub>	I	J	K	KA	MM	NA	P	S	TA	TB	TC*	ZZ	WA	WB	WH	Wθ
20	Up to 200	201to350	18	15.5	13	14	8	12	2	12	10 (12)	35	5	26	M4 Depth 7	5	6	M8	24	M5	69 (77)	11	11	M5	106 (114)	16	15 (16)	23	30°
25	Up to 300	301to400	22	19.5	17	16.5	10	14	2	12	10 (12)	40	6	31	M5 Depth 7.5	5.5	8	M10 X 1.25	29	M5	69 (77)	11	11	M6 X 0.75	111 (119)	16	15 (16)	25	30°
32	Up to 300	301to450	22	19.5	17	20	12	18	2	12	10 (12)	40	6	38	M5 Depth 8	5.5	10	M10 X 1.25	35.5	Rc(PT)1/8	71 (79)	11	10 (11)	M8 X 1.0	113 (121)	16	15 (16)	28.5	25°
40	Up to 300	301to800	30	27	19	26	16	25	2	13	10 (13)	50	8	47	M6 Depth 12	6	14	M14 X 1.5	44	Rc(PT)1/8	78 (87)	12	10 (12)	M10 X 1.25	130 (139)	16	15 (16)	33	20°
50	Up to 300	301to1200	35	32	27	32	20	30	2	14	12 (14)	58	11	58	M8 Depth 16	7	18	M18 X 1.5	55	Rc(PT)1/4	90 (102)	13	12 (13)	M12 X 1.25	150 (162)	18	17 (18)	40.5	20°
63	Up to 300	301to1200	35	32	27	38	20	32	2	14	12 (14)	58	11	72	M10 Depth 16	7	18	M18 X 1.5	69	Rc(PT)1/4	90 (102)	13	12 (13)	M14 X 1.5	150 (162)	18	17 (18)	47.5	20°
80	Up to 300	301to1400	40	37	32	50	25	40	3	20	16 (20)	71	13	89	M10 Depth 22	10	22	M22 X 1.5	80	Rc(PT)3/8	108 (122)	—	—	—	182 (196)	22	22	60.5	20°
100	Up to 300	301to1500	40	37	41	60	30	50	3	20	16 (20)	71	16	110	M12 Depth 22	10	26	M26 X 1.5	100	Rc(PT)1/2	108 (122)	—	—	—	182 (196)	22	22	71	20°

Note 1) ( ): Long stroke

Note 2) Trunnion mounting taps with width across flats NA are not attached for bore size ø80 and ø100.

Note 3) Refer to p.1.7-11 for mounting brackets.

# Series CG1 Accessory Dimensions

## Single Knuckle Joint

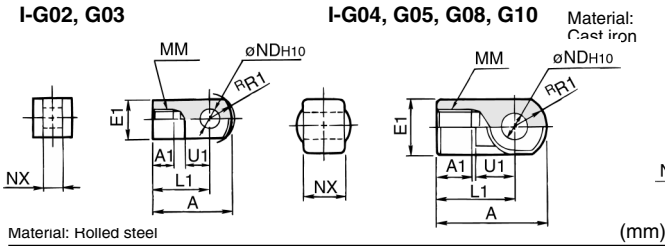

Material: Hotted steel (mm)

Part No.	Bore size (mm)	A	A1	E1	L1	MM	R1	U1	NDH10	NX
I-G02	20	34	8.5	□16	25	M8	10.3	11.5	8 <sup>+0.058</sup> <sub>0</sub>	8 <sup>-0.2</sup> <sub>-0.4</sub>
I-G03	25, 32	41	10.5	□20	30	M10 X 1.25	12.8	14	10 <sup>+0.058</sup> <sub>0</sub>	10 <sup>-0.2</sup> <sub>-0.4</sub>
I-G04	40	42	14	∅22	30	M14 X 1.5	12	14	10 <sup>+0.058</sup> <sub>0</sub>	18 <sup>-0.3</sup> <sub>-0.5</sub>
I-G05	50, 63	56	18	∅28	40	M18 X 1.5	16	20	14 <sup>+0.070</sup> <sub>0</sub>	22 <sup>-0.3</sup> <sub>-0.5</sub>
I-G08	80	71	21	∅38	50	M22 X 1.5	21	27	18 <sup>+0.070</sup> <sub>0</sub>	28 <sup>-0.3</sup> <sub>-0.5</sub>
I-G10	100	79	21	∅44	55	M26 X 1.5	24	31	22 <sup>+0.084</sup> <sub>0</sub>	32 <sup>-0.3</sup> <sub>-0.5</sub>

## Knuckle Pin

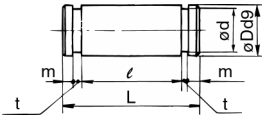

Material: Carbon steel (mm)

Part No.	Bore size (mm)	Dd9	L	d	ℓ	m	t	Applicable snap ring
IY-G02	20	8 <sup>-0.040</sup> <sub>-0.076</sub>	21	7.6	16.2	1.5	0.9	C-8 type for pivot
IY-G03	25, 32	10 <sup>-0.040</sup> <sub>-0.076</sub>	25.6	9.6	20.2	1.55	1.15	C-10 type for pivot
IY-G04	40	10 <sup>-0.040</sup> <sub>-0.076</sub>	41.6	9.6	36.2	1.55	1.15	C-10 type for pivot
IY-G05	50, 63	14 <sup>-0.050</sup> <sub>-0.093</sub>	50.6	13.4	44.2	2.05	1.15	C-14 type for pivot
IY-G08	80	18 <sup>-0.050</sup> <sub>-0.093</sub>	64	17	56.2	2.55	1.35	C-18 type for pivot
IY-G10	100	22 <sup>-0.065</sup> <sub>-0.117</sub>	72	21	64.2	2.55	1.35	C-22 type for pivot

## Clevis Pin

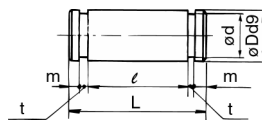

Material: Carbon steel (mm)

Part No.	Bore size (mm)	Dd9	L	d	ℓ	m	t	Applicable snap ring
CD-G02	20	8 <sup>-0.040</sup> <sub>-0.076</sub>	43.4	7.6	38.6	1.5	0.9	C-8 type for pivot
CD-G25	25	10 <sup>-0.040</sup> <sub>-0.076</sub>	48	9.6	42.6	1.55	1.15	C-10 type for pivot
CD-G03	32	12 <sup>-0.050</sup> <sub>-0.093</sub>	59.4	11.5	54	1.55	1.15	C-12 type for pivot
CD-G04	40	14 <sup>-0.050</sup> <sub>-0.093</sub>	71.4	13.4	65	2.05	1.15	C-14 type for pivot
CD-G05	50	16 <sup>-0.050</sup> <sub>-0.093</sub>	86	15.2	79.6	2.05	1.15	C-16 type for pivot
CD-G06	63	18 <sup>-0.050</sup> <sub>-0.093</sub>	105.4	17	97.8	2.45	1.35	C-18 type for pivot

\* Clevis pins and knuckle pins are common for bore size ∅80 and ∅100.

## Rod End Nut

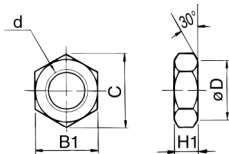

Material: Rolled steel (mm)

Part No.	Bore size (mm)	d	H1	B1	C	D
NT-02	20	M8	5	13	(15)	12.5
NT-03	25, 32	M10 X 1.25	6	17	(19.6)	16.5
NT-G04	40	M14 X 1.5	8	19	(21.9)	18
NT-05	50, 63	M18 X 1.5	11	27	(31.2)	26
NT-08	80	M22 X 1.5	13	32	(37.0)	31
NT-10	100	M26 X 1.5	16	41	(47.3)	39

## Double Knuckle Joint

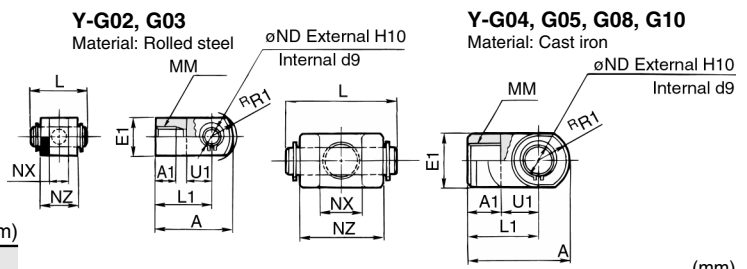

(mm)

Part No.	Bore size (mm)	A	A1	E1	L1	MM	R1	U1	ND	NX	NZ	L	Applicable pin
Y-G02	20	34	8.5	□16	25	M8	10.3	11.5	8	8 <sup>+0.4</sup> <sub>+0.2</sub>	16	21	IY-G02
Y-G03	25, 32	41	10.5	□20	30	M10 X 1.25	12.8	14	10	10 <sup>+0.4</sup> <sub>+0.2</sub>	20	25.6	IY-G03
Y-G04	40	42	16	∅22	30	M14 X 1.5	12	14	10	18 <sup>+0.5</sup> <sub>+0.3</sub>	36	41.6	IY-G04
Y-G05	50, 63	56	20	∅28	40	M18 X 1.5	16	20	14	22 <sup>+0.5</sup> <sub>+0.3</sub>	44	50.6	IY-G05
Y-G08	80	71	23	∅38	50	M22 X 1.5	21	27	18	28 <sup>+0.5</sup> <sub>+0.3</sub>	56	64	IY-G08
Y-G10	100	79	24	∅44	55	M26 X 1.5	24	31	22	32 <sup>+0.5</sup> <sub>+0.3</sub>	64	72	IY-G10

\* Knuckle pins and snap rings are attached.

## Pivot Bracket

∅20 to ∅63  
Material: Rolled steel

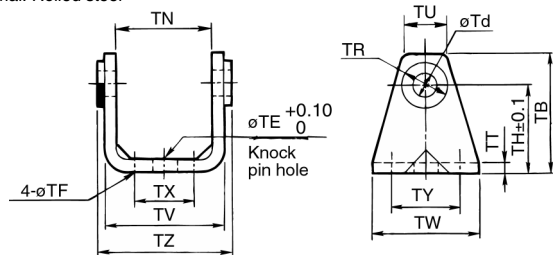

∅80 to ∅100  
Material: Cast iron

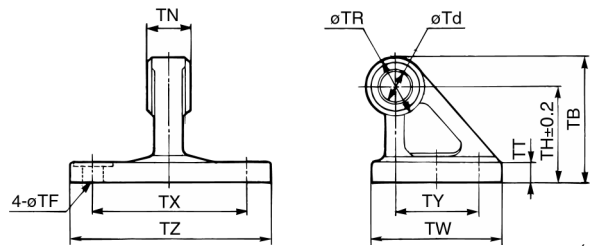

(mm)

Part No.	Bore size (mm)	TB	Td	TE	TF	TH	TN	TR	TT
CG-020-24A	20	36	8	10	5.5	25	(29.3)	13	3.2
CG-025-24A	25	43	10	10	5.5	30	(33.1)	15	3.2
CG-032-24A	32	50	12	10	6.6	35	(40.4)	17	4.5
CG-040-24A	40	58	14	10	6.6	40	(49.2)	21	4.5
CG-050-24A	50	70	16	20	9	50	(60.4)	24	6
CG-063-24A	63	82	18	20	11	60	(74.6)	26	8
CG-080-24A	80	73	18	—	11	55	28 <sup>-0.1</sup> <sub>-0.3</sub>	36	11
CG-100-24A	100	90	22	—	13.5	65	32 <sup>-0.1</sup> <sub>-0.3</sub>	50	12

Part No.	Bore size (mm)	TU	TV	TW	TX	TY	TZ	Applicable pin O.D.
CG-020-24A	20	18.1	35.8	42	16	28	38.3	8d9 <sup>-0.040</sup> <sub>-0.076</sub>
CG-025-24A	25	20.7	39.8	42	20	28	42.1	10d9 <sup>-0.040</sup> <sub>-0.076</sub>
CG-032-24A	32	23.6	49.4	48	22	28	53.8	12d9 <sup>-0.050</sup> <sub>-0.093</sub>
CG-040-24A	40	27.3	58.4	56	30	30	64.6	14d9 <sup>-0.050</sup> <sub>-0.093</sub>
CG-050-24A	50	29.7	72.4	64	36	36	79.2	16d9 <sup>-0.050</sup> <sub>-0.093</sub>
CG-063-24A	63	34.3	90.4	74	46	46	97.2	18d9 <sup>-0.050</sup> <sub>-0.093</sub>
CG-080-24A	80	—	—	72	85	45	110	18d9 <sup>-0.050</sup> <sub>-0.093</sub>
CG-100-24A	100	—	—	93	100	60	130	22d9 <sup>-0.065</sup> <sub>-0.117</sub>

CG1

CJ1

CJP

CJ2

CM2

C85

C76

CG1

MB

MB1

CP95

C95

C92

CA1

CS1

## Series CDG1

# Auto Switch Specifications

Refer to p.5.3-2 for details of the auto switch.



### Applicable auto switch

Auto switch model		Electrical entry (Function)	Applicable bore size	Page
Reed switch	<b>D-C7, C8</b>	Grommet	ø20 to ø63	5.3-9
	<b>D-C73C, C80C</b>	Connector		5.3-11
	<b>D-B5, B6</b>	Grommet	ø20 to ø100	5.3-10
	<b>D-B59W</b>	Grommet (2 colour indicator)		5.3-25
Solid state switch	<b>D-H7□</b>	Grommet	ø20 to ø63	5.3-29
	<b>D-H7□W</b>	Grommet (2 colour)		5.3-42
	<b>D-H7LF</b>	Grommet (2 colour, Latch with diagnostic output)		5.3-49
	<b>D-H7NF</b>	Grommet (2 colour, Diagnostic output)		5.3-50
	<b>D-H7BA</b>	Grommet (2 colour, Water resistant)	5.3-55	
	<b>D-H7C</b>	Connector	5.3-31	
	<b>D-G5, K5</b>	Grommet	ø20 to ø100	5.3-30
	<b>D-G5□W, K59W</b>	Grommet (2 colour)		5.3-43
	<b>D-G59F</b>	Grommet (2 colour, Diagnostic output)		5.3-51
	<b>D-G5NT</b>	Grommet (With timer)		5.3-59
<b>D-G5BA</b>	Grommet (2 colour, Water resistant)	5.3-56		



## Precautions

- ! Be sure to read before handling.
- ! Refer to p.0-44 to 0-46 for Safety Instructions and common precautions.

## Auto Switch Mounting Position and Mounting Height

**D-C7, D-C8**  
ø20 to ø63

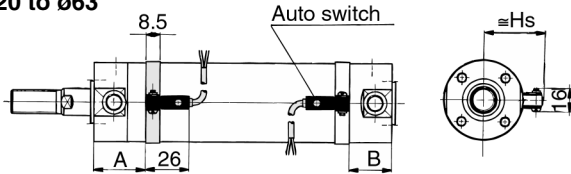

**D-G5, D-K5, D-G5□W, D-G5BA**  
**D-K59W, D-G59F, D-G5NT**

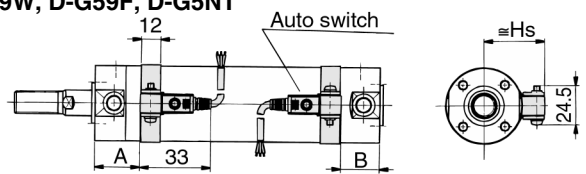

**D-H7, D-H7□W**  
**D-H7□F, D-H7BA**  
ø20 to ø63

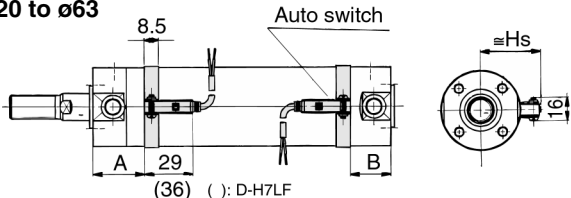

**D-C73C, D-C80C**  
ø20 to ø63

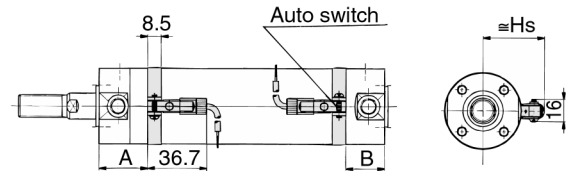

**D-B5, D-B6, D-B59W**  
ø20 to ø100

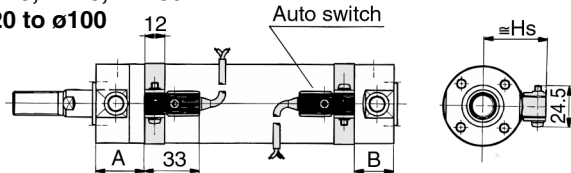

**D-H7C**  
ø20 to ø63

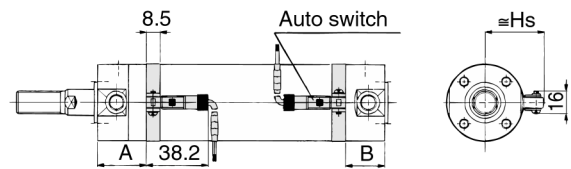

### Auto Switch Mounting Position

Auto switch model	D-C7,C8 D-C73C D-C80C		D-B5,B6 D-G5□W, K59W D-G59F D-G5BAL		D-B59W		D-H7□ D-H7C		D-H7□W D-H7□F D-H7BAL		D-G5 D-K5 D-G5NTL	
	A	B	A	B	A	B	A	B	A	B	A	B
Bore												
20	30	20.5 (28.5)	24	15 (22.5)	27	17.5 (25.5)	29	19.5 (27.5)	27.5	18 (26)	25.5	16 (24)
25	30	20.5 (28.5)	24	15 (22.5)	27	17.5 (25.5)	29	19.5 (27.5)	27.5	18 (26)	25.5	16 (24)
32	31	21.5 (29.5)	25	15.5 (23.5)	28	18.5 (26.5)	30	20.5 (28.5)	28.5	19 (27)	26.5	17 (25)
40	35.5	24 (33)	29.5	18 (27)	32.5	21 (30)	34.5	23 (32)	33	21.5 (30.5)	31	19.5 (28.5)
50	43	28.5 (40.5)	37	22.5 (34.5)	40	25.5 (37.5)	42	27.5 (39.5)	40.5	26 (38)	38.5	24 (36)
63	43	28.5 (40.5)	37	22.5 (34.5)	40	25.5 (37.5)	42	27.5 (39.5)	40.5	26 (38)	38.5	24 (36)
80	—	—	46.5	31 (45)	49.5	34 (48)	—	—	—	—	48	32.5 (46.5)
100	—	—	46.5	31 (45)	49.5	34 (48)	—	—	—	—	48	32.5 (46.5)

### (mm) Mounting Height

D-C7,C8 D-H7□ D-H7□W D-H7□F D-H7BAL		D-C73C D-C80C	D-B5,B6 D-B59W D-G5, K5 D-G5□W D-K59W	D-G5NTL D-G59F D-H7C D-G5BAL
HS		HS	HS	
24.5		27	27.5	
27		29.5	30	
30.5		33	33.5	
35		37.5	38	
40.5		43	43.5	
47.5		50	50.5	
—		—	59	
—		—	69.5	

( ) : Long stroke, bore size ø20 to ø100, Double rod

### Auto Switch Mounting Bracket and Surface

St: Stroke (mm)

Mounting bracket	Basic/Foot/Flange/Clevis			Trunnion*		
	1 (Front side)	2 (On different surfaces)	2 (On the same surface)	1	2 (On different surfaces)	2 (On the same surface)
Number of switches	1	2	2	1	2	2
Mounting surface	Surface with port	Surface with port	Surface with port			
Auto switch model						
D-C7, C8	10st or more	15 to 49st	50st or more	10st or more	15 to 49st	50st or more
D-H7□, H7□W D-H7BA, H7NF	10st or more	15 to 59st	60st or more	10st or more	15 to 59st	60st or more
D-C73C, C80C, H7C	10st or more	15 to 64st	65st or more	10st or more	15 to 64st	65st or more
D-H7LF	10st or more	20 to 64st	65st or more	10st or more	20 to 64st	65st or more
D-B5, B6, G5□, K5 D-G5□W, K59W, G5BA D-G59F, G5NT	10st or more	15 to 74st	75st or more	10st or more	15 to 74st	75st or more
D-B59W	15st or more	20 to 74st	75st or more	15st or more	20 to 74st	75st or more

\* Trunnion style is not available for bore sizes 80 and 100.

CJ1
CJP
CJ2
CM2
C85
C76
<b>CG1</b>
MB
MB1
CP95
C95
C92
CA1
CS1

# Standard: Double Acting Double Rod

# Series CG1W

ø20, ø25, ø32, ø40, ø50, ø63, ø80, ø100

## How to Order

**Standard**

CG1W L N 25 — 100

**With auto switch**

CDG1W L N 25 — 100   B53

**With auto switch (magnet)**

**Double acting/Double rod**

**Mounting**

<b>B</b>	Basic
<b>L</b>	Axial foot
<b>F</b>	Front flange
<b>U*</b>	Front trunnion

\* Not available for bore sizes ø80 and ø100.  
\*\* Mounting brackets are included, not mounted.

**Cushion**

<b>N</b>	Rubber bumper
<b>A</b>	Air cushion

**Bore size**

<b>20</b>	20mm	<b>50</b>	50mm
<b>25</b>	25mm	<b>63</b>	63mm
<b>32</b>	32mm	<b>80</b>	80mm
<b>40</b>	40mm	<b>100</b>	100mm

\* Mounting accessories are not mounted, should be order separate. Please refer order keys in next pages.

**Applicable auto switch**

—	Without auto switch (Built-in magnet)
---	---------------------------------------

\* Refer to the table below for selecting applicable auto switches.

**Rod boot**

—	Without rod boot
One side	<b>J</b> Nylon tarpaulin
Both sides	<b>K</b> Heat resistant tarpaulin
Both sides	<b>JJ</b> Nylon tarpaulin
Both sides	<b>KK</b> Heat resistant tarpaulin

\* In case of foot brackets and front flanges, rod boots are mounted when shipped.

**Number of auto switches**

—	2
<b>S</b>	1
<b>n</b>	n

**Cylinder stroke (mm)**

Refer to p.1.7-15 for Standard Stroke Table.

### Applicable Auto Switches/Refer to p.5.3-2 for further information on auto switch.

Style	Special function	Electrical entry	Indicator	Wiring (output)	Load voltage		Auto switch model		Lead wire (m)*				Applicable load					
					DC	AC	Applicable bore size		0.5 (-)	3 (L)	5 (Z)	None (N)						
							ø20 to ø63	ø20 to ø100										
Reed switch	—	Grommet	Yes	3 wire (NPN)	—	5V	—	<b>C76</b>	—	●	●	—	—	IC				
								2 wire	24V	12V	—	<b>B53</b>	●	●	●	—	—	PLC
											—	<b>B54</b>	●	●	●	—	—	—
											—	<b>B64</b>	●	●	—	—	—	—
		Connector	No	Yes	No	2 wire	24V	5V, 12V	100V or less	<b>C73</b>	—	●	●	●	—	IC		
										<b>C80</b>	—	●	●	—	—	—	IC	
										<b>C73C</b>	—	●	●	●	●	—	—	Relay PLC
										<b>C80C</b>	—	●	●	●	●	—	—	IC
Diagnostic indication (2 colour)	Grommet	Yes	—	—	—	—	<b>B59W</b>	—	●	●	—	—	—					
Solid state switch	—	Grommet	Yes	3 wire (NPN)	24V	5V, 12V	—	<b>H7A1</b>	<b>G59</b>	●	●	○	—	IC				
				3 wire (PNP)				<b>H7A2</b>	<b>G5P</b>	●	●	○	—	—				
		2 wire		<b>H7B</b>				<b>K59</b>	●	●	○	—	—					
		—		<b>H7C</b>				—	●	●	●	●	—	—				
	Diagnostic indication (2 colour)	Grommet	Yes	3 wire (NPN)	24V	5V, 12V	—	<b>H7NW</b>	<b>G59W</b>	●	●	○	—	IC				
				3 wire (PNP)				<b>H7PW</b>	<b>G5PW</b>	●	●	○	—	—				
				2 wire				<b>H7BW</b>	<b>K59W</b>	●	●	○	—	—				
				—				<b>H7BA</b>	<b>G5BA</b>	—	●	○	—	—				
				—				<b>G5NT</b>	—	●	○	—	—	—				
				4 wire (NPN)				<b>H7NF</b>	<b>G59F</b>	●	●	○	—	IC				
Latch with diagnostic output (2 colour)	—	—	—	—	—	<b>H7LF</b>	—	●	●	○	—	—						

\*Lead wire length 0.5m.....Z 3m.....L e.g.) C73C 5m.....Z C73CL None.....N e.g.) C73CZ C73CN

\*Solid state switches marked with "○" are manufactured upon receipt of order.

# Standard: Double Acting Double Rod *Series CG1W*



## Specifications

Bore size (mm)	20	25	32	40	50	63	80	100
Action	Double acting/Double rod							
Lubrication	Non-lube							
Fluid	Air							
Proof pressure	1.5MPa							
Max. operating pressure	1.0MPa							
Min. operating pressure	0.05MPa							
Ambient and fluid temperature	Without auto switch: -10°C to +70°C (No freezing)							
	With auto switch: -10°C to +60°C (No freezing)							
Piston speed	50 to 1000mm/s						50 to 700mm/s	
Stroke tolerance	Up to 1000 <sup>+1.4</sup> <sub>0</sub> mm,						Up to 1000 <sup>+1.4</sup> <sub>0</sub> mm	
	Up to 1200 <sup>+1.8</sup> <sub>0</sub> mm						Up to 1500 <sup>+1.8</sup> <sub>0</sub> mm	
Thread tolerance	JIS class 2							
Cushion	Rubber bumper/Air cushion							
Mounting*	Basic, Axial foot, Front flange, Front trunnion							



\* Front trunnion style is not available for bore sizes ø80 and ø100. \*\* No freezing

## Accessories

Mounting		Basic	Axial foot	Front flange	Front trunnion
Standard	Rod end nut	●	●	●	●
Option	Single knuckle joint	●	●	●	●
	Double knuckle joint** (With pins)	●	●	●	●
	Pivot bracket*	—	—	—	●*
	Rod boot	●	●	●	●

\* Pivot bracket is not available for bore size ø80 and ø100.

\*\* Pins and snap rings for double knuckle joint are included, not mounted.

## Stroke

Bore size(mm)	Standard stroke (mm) <sup>(1)</sup>	Long stroke (mm)	Max. stroke
20	25, 50, 75, 100, 125, 150, 200 250, 300	201 to 350	1500
25		301 to 400	
32		301 to 450	
40		301 to 800	
50/63		301 to 1200	
80		301 to 1400	
100		301 to 1500	

Note 1) Other intermediate strokes can be manufactured upon receipt of order. Spacers are not used for the intermediate strokes. Refer to p.1.7-17 to 1.7-19 for dimensions.

Note 2) Long stroke applies to the axial foot style and the front flange style. If other mounting brackets are used, or the length exceeds the long stroke limit, the stroke should be determined based on the stroke selection table in the technical data.

## JIS symbol

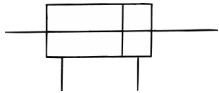

## Order Made Made to Order

Refer to p.5.4-1 for made to order products of series CG1.

## Mounting Bracket

Refer to p.1.7-19 for part numbers of the mounting brackets.

## Auto Switch Mounting Band

Refer to p.1.7-19 for part numbers of the mounting bands.

## With Auto Switch

The auto switch can be mounted. Refer to p.1.7-12 to 1.7-14 for the details.

## Rod Boot Materials

Symbol	Material	Max. operating temp
J	Nylon tarpaulin	70°C
K	Heat resistant tarpaulin	110°C*

\* Maximum ambient temperature for the rod boot only.

CJ1

CJP

CJ2

CM2

C85

C76

CG1

MB

MB1

CP95

C95

C92

CA1

CS1

# Series CG1W

## Weight

Bore size (mm)		20	25	32	40	50	63	80	100
Basic weight	Basic	0.13	0.22	0.33	0.55	1.02	1.37	2.64	4.09
	Axial foot	0.24	0.35	0.49	0.77	1.50	2.09	3.60	5.84
	Flange	0.21	0.32	0.47	0.75	1.36	1.87	3.35	5.44
	Trunnion	0.14	0.24	0.36	0.60	1.16	1.51	—	—
Pivot bracket		0.08	0.09	0.17	0.25	0.44	0.80	—	—
Single knuckle joint		0.05	0.09	0.09	0.10	0.22	0.22	0.39	0.57
Double knuckle joint (with pins)		0.05	0.09	0.09	0.13	0.26	0.26	0.64	1.31
Additional weight by each 50 stroke		0.07	0.10	0.13	0.23	0.34	0.38	0.54	0.77
Additional weight by air cushion		0.01	0.01	0.02	0.02	0.03	0.03	0.09	0.10

Calculation example: **CG1WLN32-100** (Foot, ø32, 100 stroke)

- Basic weight.....0.49 (Foot, ø32)      • Cylinder stroke.....100 stroke
- Additional weight.....0.13/50 stroke      0.49+0.13 X 100/50=0.75kg

## ⚠ Precautions

- Be sure to read before handling.
- Refer to p.0-39 to 0-46 for Safety Instructions and common precautions.
- Refer to p.1.1-6 for precautions on series CG1.

## Construction

### With rubber bumper

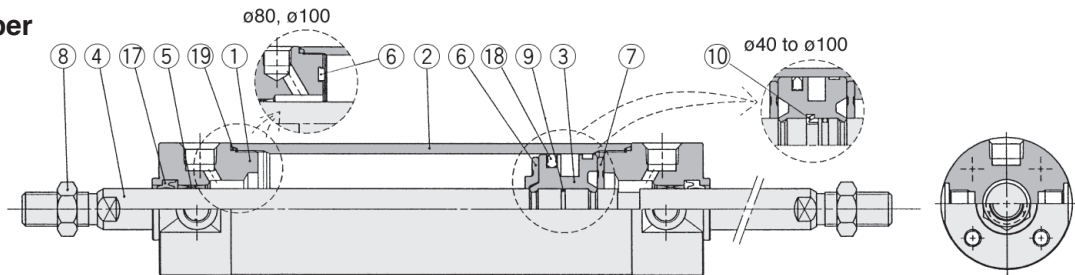

### With air cushion

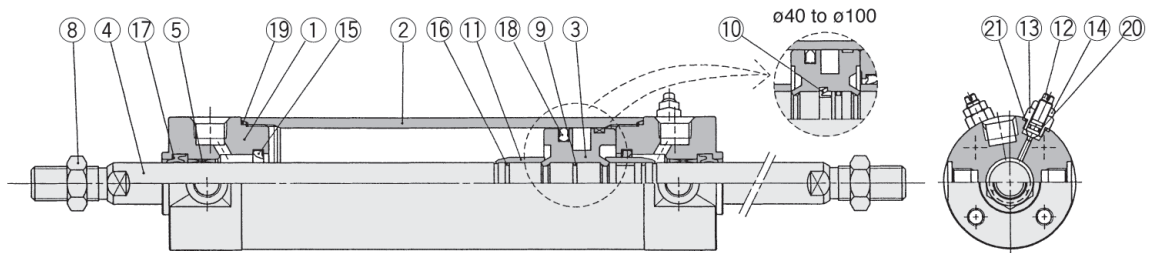

## Component Parts

No.	Description	Material	Note
①	Rod cover	Aluminum alloy	White hard anodized
②	Cylinder tube	Aluminum alloy	Hard anodized
③	Piston	Aluminum alloy	Chromated
④	Piston rod A	Carbon steel	Hard chrome plated
⑤	Bushing	Oil impregnated sintered alloy	ø40 or more: Lead bronze cast
⑥	Bumper A	Urethane	
⑦	Bumper B	Urethane	ø40 or more: the same as bumper A
⑧	Rod end nut	Rolled steel	Nickel plated
⑨	Piston gasket	NBR	
⑩	Piston holder	Urethane	ø40 or more*
⑪	Cushion ring A	Brass	
⑫	Cushion valve	Rolled steel	Electroless nickel plated
⑬	Valve retainer	Rolled steel	Electroless nickel plated
⑭	Lock nut	Carbon steel	Nickel plated
⑮	Cushion seal A	Urethane	
⑯	Cushion ring gasket A	NBR	

Note) A rubber magnet is equipped on the piston of the cylinder with auto switch.

\* The material is stainless steel on auto switch equipped styles ø20 and ø25.

## Replacement Parts/With rubber bumper

No.	Description	Material	Bore size (mm)/Part No.							
			ø20	ø25	ø32	ø40	ø50	ø63	ø80	ø100
⑰	Rod seal	NBR	PDU-8Z	PDU-10Z	PDU-12LZ	PDU-16Z	PDU-20Z	PDU-20Z	PDU-25Z	PDU-30Z
⑱	Piston seal	NBR	PPD-20	PPD-25-19	PPD-32	PPD-40	PPD-50	PPD-63	PPD-80	PPD-100
⑲	Tube gasket	NBR	CM-020-16-123	CM-025-16-124	CM-032-16-126	CM-040-16-127	CM-050-16-128	CM-063-16-129	CM-080-16-152	CM-100-16-153

With air cushion (Parts ⑰ to ⑲ are the same as rubber bumper style.)

⑳	Valve seal	NBR	O ring ø4.5 X ø2.5 X ø1	O ring ø5.5 X ø3.5 X ø1	O ring ø6.5 X ø4.5 X ø1
㉑	Gasket for valve retainer	NBR	O ring ø6.4 X ø5.2 X ø0.6	O ring ø7.4 X ø5.8 X ø0.8	O ring ø11.4 X ø9.4 X ø1



# Standard: Double Acting Double Rod *Series CG1W*

## Air-hydro

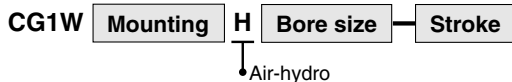

A low hydraulic pressure cylinder used at a pressure of 1.0MPa or below. Through the concurrent use of a CC series air-hydro unit, it is possible to operate at a constant or low speed or to effect an intermediate stop, just like a hydraulic unit, while using pneumatic equipment such as a valve.

### Specifications

Style	Air-hydro Cylinder
Bore size (mm)	ø20, ø25, ø32, ø40, ø50, ø63
Action	Double acting
Fluid	Turbine oil
Proof pressure	1.5MPa
Max. operating pressure	1.0MPa
Min. operating pressure	0.18MPa
Piston speed	15 to 300mm/s
Cushion	None
Ambient and fluid temperature	+5 to 60°C
Thread tolerance	JIS class 2
Stroke tolerance	Up to 1000 <sup>+1.4</sup> <sub>0</sub> mm, Up to 1200 <sup>+1.8</sup> <sub>0</sub> mm
Mounting	Basic, Axial foot, Front flange, Front trunnion.

\* Auto switch can be mounted.

Bore size	ø20	ø25	ø32	ø40	ø50	ø63
S	70	70	72	80	95	95
ZZ	140	150	152	180	211	211

Other dimensions are the same as double rod standard (p.1.7-18).

## Basic CG1WBA: With Air Cushion

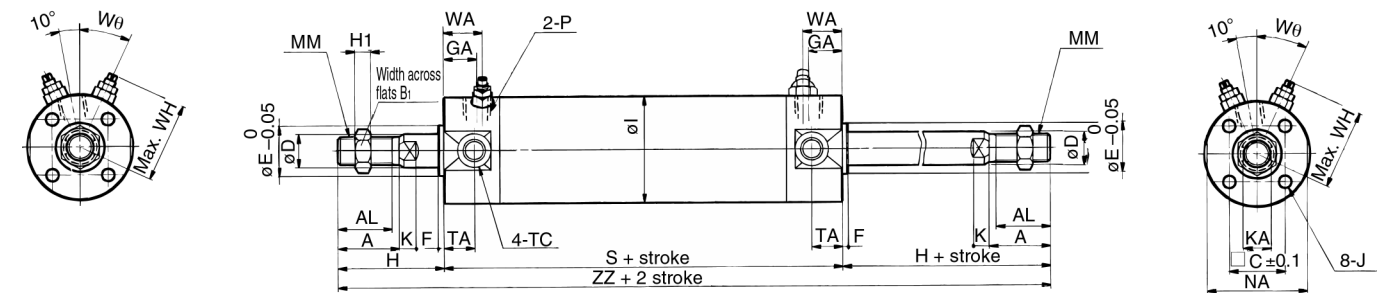

\* Refer to rubber bumper equipped type for rod boot equipped type. (mm)

Bore size (mm)	Standard stroke range (mm)	Long stroke range (mm)	A	AL	B <sub>1</sub>	C	D	E	F	GA	H	H <sub>1</sub>	I	J	K	KA
20	Up to 200	201 to 350	18	15.5	13	14	8	12	2	12	35	5	26	M4 Depth 7	5	6
25	Up to 300	301 to 400	22	19.5	17	16.5	10	14	2	12	40	6	31	M5 Depth 7.5	5.5	8
32	Up to 300	301 to 450	22	19.5	17	20	12	18	2	12	40	6	38	M5 Depth 8	5.5	10
40	Up to 300	301 to 800	30	27	19	26	16	25	2	13	50	8	47	M6 Depth 12	6	14
50	Up to 300	301 to 1200	35	32	27	32	20	30	2	14	58	11	58	M8 Depth 16	7	18
63	Up to 300	301 to 1200	35	32	27	38	20	32	2	14	58	11	72	M10 Depth 16	7	18
80	Up to 300	301 to 1400	40	37	32	50	25	40	3	20	71	13	89	M10 Depth 22	10	22
100	Up to 300	301 to 1500	40	37	41	60	30	50	3	20	71	16	110	M12 Depth 22	10	26

Bore size (mm)	MM	NA	P	S	TA	TC**	ZZ	WA	WH	Wθ
20	M8	24	M5	77	11	M5	147	16	23	30°
25	M10 X 1.25	29	M5	77	11	M6 X 0.75	157	16	25	30°
32	M10 X 1.25	35.5	Rc(PT)1/8	79	11	M8 X 1.0	159	16	28.5	25°
40	M14 X 1.5	44	Rc(PT)1/8	87	12	M10 X 1.25	187	16	33	20°
50	M18 X 1.5	55	Rc(PT)1/4	102	13	M12 X 1.25	218	18	40.5	20°
63	M18 X 1.5	69	Rc(PT)1/4	102	13	M14 X 1.5	218	18	47.5	20°
80	M22 X 1.5	80	Rc(PT)3/8	122	—	—	264	22	60.5	20°
100	M26 X 1.5	100	Rc(PT)1/2	122	—	—	264	22	71	20°

\* Refer to p.1.6-19 for mounting brackets.  
\*\* Trunnion mounting taps with width across flats NA are not attached for bore sizes ø80 and ø100.

## Copper Free

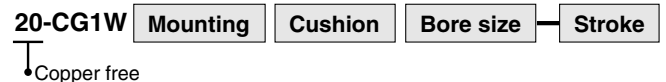

This cylinder eliminates any influences of copper ions or fluororesins on colour CRTs. Copper materials have been nickel plated or replaced with non-copper materials to prevent the generation of copper ions.

### Specifications

Bore (mm)	ø20, ø25, ø32, ø40, ø50, ø63, ø80, ø100	
Action	Double acting	
Fluid	Air	
Max. operating pressure	1.0MPa	
Min. operating pressure	0.05MPa	
Cushion	N	Rubber bumper
	A	Air cushion
Piston speed	ø20 to ø63	50 to 1000mm/s
	ø80, ø100	50 to 700mm/s
Mounting*	Basic, Axial foot, Front flange, Front trunnion	

\* Front trunnion style is not available for bore sizes ø80 and ø100. Refer to p.1.7-18 for dimensions.

\* Auto switch can be mounted.

CJ1

CJP

CJ2

CM2

C85

C76

CG1

MB

MB1

CP95

C95

C92

CA1

CS1

# Series CG1W

## Basic/CG1WBN: With Rubber Bumper

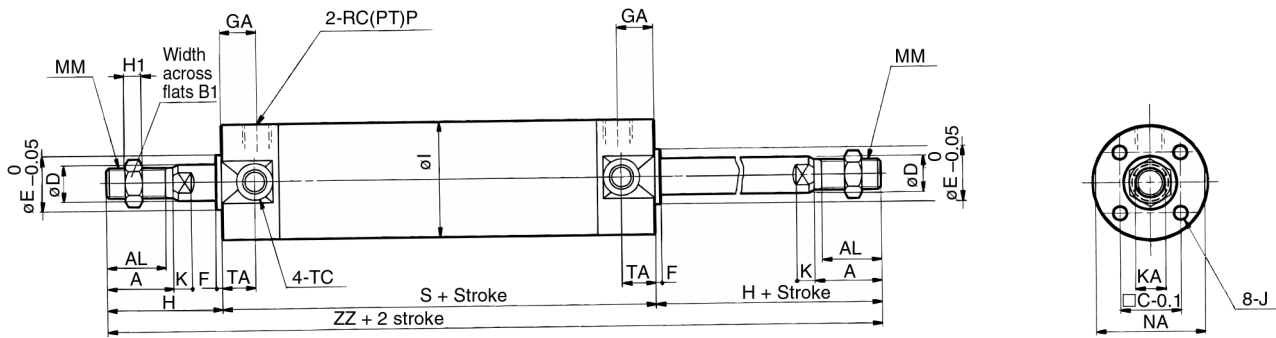

With rod boot on one side

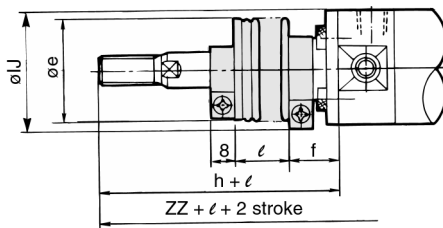

With rod boot on both sides

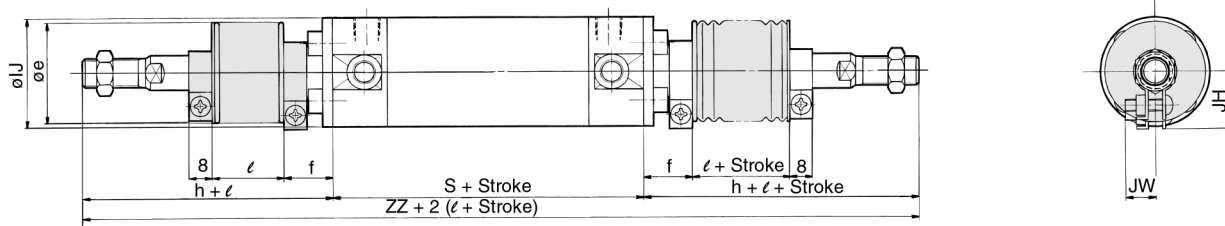

Bore (mm)	Stroke range (mm)	A	AL	B <sub>1</sub>	□C	D	E	F	GA	H <sub>1</sub>	I	J	K	KA	MM	NA	P	S
20	Up to 350	18	15.5	13	14	8	12	2	12	5	26	M4 Depth 7	5	6	M8	24	1/8	77
25	Up to 400	22	19.5	17	16.5	10	14	2	12	6	31	M5 Depth 7.5	5.5	8	M10 X 1.25	29	1/8	77
32	Up to 450	22	19.5	17	20	12	18	2	12	6	38	M5 Depth 8	5.5	10	M10 X 1.25	35.5	1/8	79
40	Up to 800	30	27	19	26	16	25	2	13	8	47	M6 Depth 12	6	14	M14 X 1.5	44	1/8	87
50	Up to 1200	35	32	27	32	20	30	2	14	11	58	M8 Depth 16	7	18	M18 X 1.5	55	1/4	102
63	Up to 1200	35	32	27	38	20	32	2	14	11	72	M10 Depth 16	7	18	M18 X 1.5	69	1/4	102
80	Up to 1400	40	37	32	50	25	40	3	20	13	89	M10 Depth 22	10	22	M22 X 1.5	80	3/8	122
100	Up to 1500	40	37	41	60	30	50	3	20	16	110	M12 Depth 22	10	26	M26 X 1.5	100	1/2	122

Bore (mm)	TA	TC**	W/o rod boot		W/ rod boot on one side*							W/ rod boot on both sides*	
			H	ZZ	e	f	h	IJ	JH	JW	l	ZZ	
20	11	M5	35	147	30	16	55	27	(14.5)	(11.5)	0.25 stroke	167	187
25	11	M6 X 0.75	40	157	30	17	62	32	(17.5)	(11.5)		179	201
32	11	M8 X 1.0	40	159	35	17	62	38	(19.5)	(11.5)		181	203
40	12	M10 X 1.25	50	187	35	17	70	48	(22.5)	(13)		207	227
50	13	M12 X 1.25	58	218	40	17	78	59	(25)	(13)		238	258
63	13	M14 X 1.5	58	218	40	18	78	72	(25)	(13)		238	258
80	—	—	71	264	52	10	80	59	—	—		273	282
100	—	—	71	264	62	7	80	71	—	—		273	282

### Air hydro

Bore (mm)	S	ZZ
20	70	140
25	70	150
32	72	152
40	80	180
50	95	211
63	95	211



\* The minimum stroke for rod boot equipped style is 20mm.

\*\* Trunnion mounting taps with width across flats NA are not attached for bore sizes 80 and 100.

# Standard: Double Acting Double Rod *Series CG1W*

## With Mounting Bracket

### Axial foot/CG1WLN

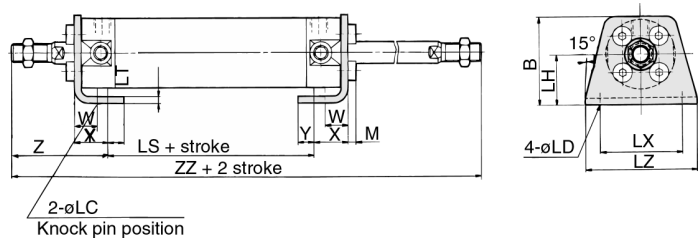

### Foot

		(mm)												
Bore (mm)	Stroke range (mm)	B	LC	LD	LH	LS	LT	LX	LZ	M	W	X	Y	Z
20	Up to 350	34	4	6	20	53	3	32	44	3	10	15	7	47
25	Up to 400	38.5	4	6	22	53	3	36	49	3.5	10	15	7	52
32	Up to 450	45	4	6.6	25	53	3	44	58	3.5	10	16	8	53
40	Up to 800	54.5	4	6.6	30	60	3	54	71	4	10	16.5	8.5	63.5
50	Up to 1200	70.5	5	9	40	67	4.5	66	86	5	17.5	22	11	75.5
63	Up to 1200	82.5	5	11	45	67	4.5	82	106	5	17.5	22	13	75.5
80	Up to 1400	101	6	11	55	74	4.5	100	125	5	20	28.5	14	95
100	Up to 1500	121	6	14	65	74	6	120	150	7	20	30	16	95

### Front flange/CG1WFN

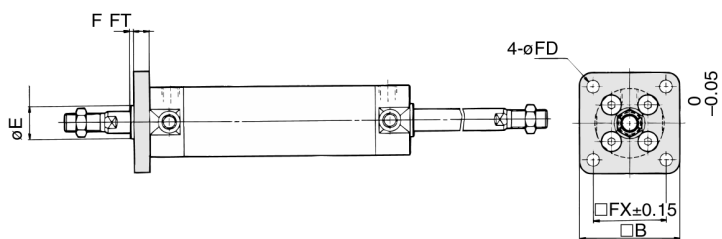

### Front flange

		(mm)						
Bore (mm)	Stroke range (mm)	B	E	F	FX	FD	FT	
20	Up to 350	40	12	2	28	5.5	6	
25	Up to 400	44	14	2	32	5.5	7	
32	Up to 450	53	18	2	38	6.6	7	
40	Up to 800	61	25	2	46	6.6	8	
50	Up to 1200	76	30	2	58	9	9	
63	Up to 1200	92	32	2	70	11	9	
80	Up to 1400	104	40	3	82	11	11	
100	Up to 1500	128	50	3	100	14	14	

\* End boss is machined on the flange for øE.

### Front trunnion/CG1WUN

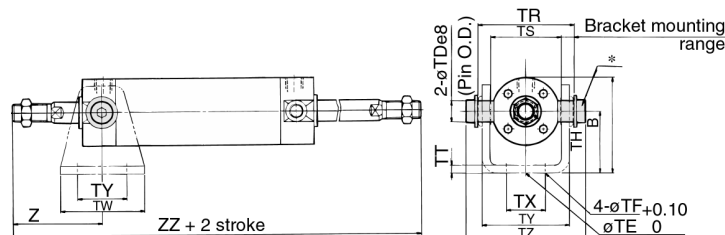

### Front trunnion

		(mm)								
Bore (mm)	Stroke range (mm)	B	TDe8	TE	TF	TH	TR	TS	TT	
20	Up to 200	38	8 <sup>-0.025</sup> <sub>-0.047</sub>	10	5.5	25	39	28		
25	Up to 300	45.5	10 <sup>-0.025</sup> <sub>-0.047</sub>	10	5.5	30	43	33		
32	Up to 300	54	12 <sup>-0.032</sup> <sub>-0.059</sub>	10	6.6	35	54.5	40		
40	Up to 500	63.5	14 <sup>-0.032</sup> <sub>-0.059</sub>	10	6.6	40	65.5	49		
50	Up to 600	79	16 <sup>-0.032</sup> <sub>-0.059</sub>	20	9	50	80	60		
63	Up to 600	96	18 <sup>-0.032</sup> <sub>-0.059</sub>	20	11	60	98	74		

		(mm)						
Bore (mm)	TT	TV	TW	TX	TY	TZ	Z	
							Without rod boot	With rod boot
20	3.2	35.8	42	16	28	47.6	46	66 + ℓ
25	3.2	39.8	42	20	28	53	51	73 + ℓ
32	4.5	49.4	48	22	28	67.7	51	73 + ℓ
40	4.5	58.4	56	30	30	78.7	62	82 + ℓ
50	6	72.4	64	36	36	98.6	71	91 + ℓ
63	8	90.4	74	46	46	119.2	71	91 + ℓ

\* Consists of pins, flat washer and hexagon socket head cap bolt.

### Mounting Bracket Part No.

Mounting bracket	Bore size (mm)							
	20	25	32	40	50	63	80	100
Axial foot*	CG-L020	CG-L025	CG-L032	CG-L040	CG-L050	CG-L063	CG-L080	CG-L100
Flange	CG-F020	CG-F025	CG-F032	CG-F040	CG-F050	CG-F063	CG-F080	CG-F100
Trunnion pin	CG-T020	CG-T025	CG-T032	CG-T040	CG-T050	CG-T063	—	—
Pivot bracket	CG-020 -24A	CG-025 -24A	CG-032 -24A	CG-040 -24A	CG-050 -24A	CG-063 -24A	—	—

\* Order two foot brackets per a cylinder.

\*\* Mounting bolts are attached for the foot and the flange styles.

### Auto Switch Mounting Bracket Part No.

Auto switch model	Bore size (mm)							
	20	25	32	40	50	63	80	100
D-C7, C8	BMA2	BMA2	BMA2	BMA2	BMA2	BMA2	—	—
D-H7	-020	-025	-032	-040	-050	-063	—	—
D-B5, B6	BA-01	BA-02	BA-32	BA-04	BA-05	BA-06	BA-08	BA-10
D-G5, K5								



Note) A set of following stainless steel mounting screws is attached. (A switch mounting band is not attached. Please order the band separately.)

BBA3: D-B5/B6/G5 types  
BBA4: D-C7/C8/H7 types

\* "D-G5BAL" and "D-H7BAL" switches are set on the cylinder with the screws above when shipped. When a switch only is shipped, "BBA3" or "BBA4" screws are attached.

# Standard: Single Acting Spring Return/Extend

# Series CG1

ø20, ø25, ø32, ø40

## How to Order

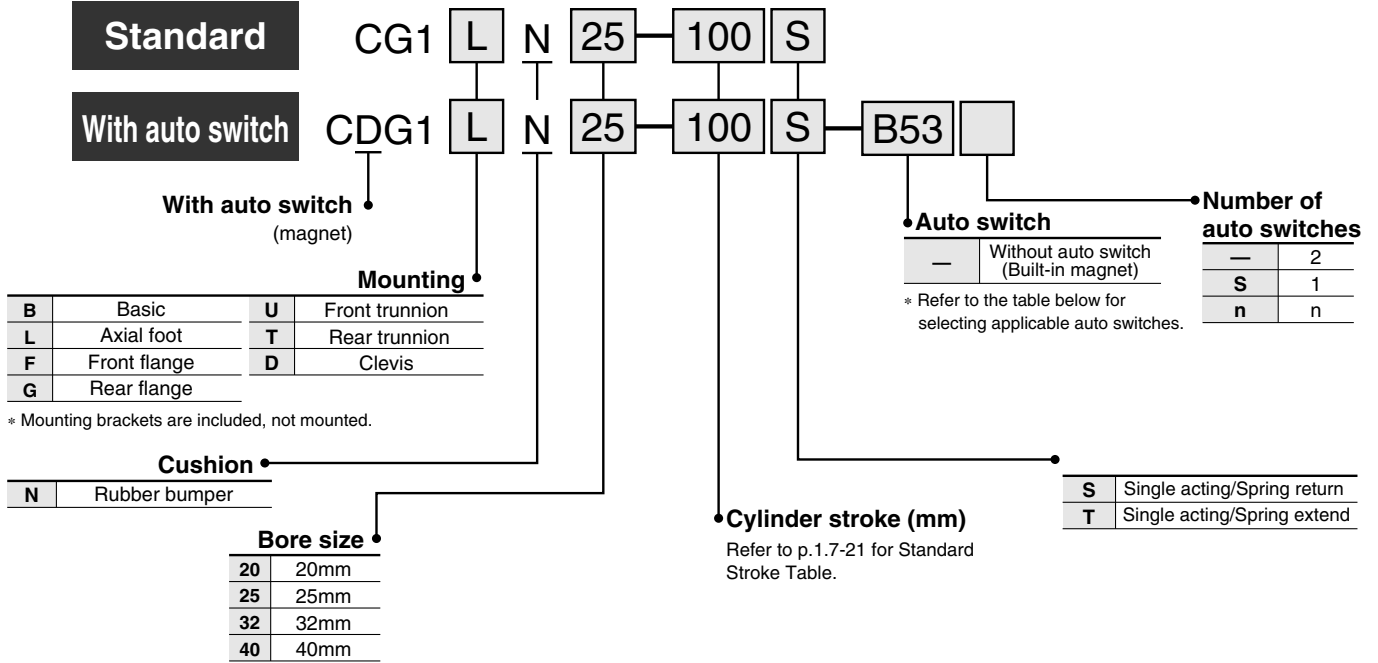

### Applicable Auto Switches/Refer to p.5.3-2 for further information on auto switch.

Style	Special function	Electrical entry	Indicator	Wiring (output)	Load voltage		Auto switch model		Lead wire (m)*				Applicable load		
					DC	AC	0.5 (-)	3 (L)	5 (Z)	None (N)					
Reed switch	—	Grommet	Yes	3 wire (NPN)	—	5V	—	C76	—	●	●	—	—	IC	
					—	—	—	—	B53	●	●	●	—	—	PLC
				2 wire	24V	—	200V or less	—	B54	●	●	●	—	—	Relay PLC
						12V	100V	C73	—	●	●	●	—	—	
						5V, 12V	100V or less	C80	—	●	●	—	—	IC	
				Connector	Yes	12V	—	C73C	—	●	●	●	●	—	—
						5V, 12V	24V or less	C80C	—	●	●	●	●	—	IC
Diagnostic indication (2 colour)	Grommet	Yes	—	—	B59W	●	●	—	—	—	—				
Solid state switch	—	Grommet	Yes	2 wire	12V	—	—	K59	●	●	○	—	—		
				3 wire (NPN)	5V, 12V	—	H7A1	G59	●	●	○	—	IC		
				3 wire (PNP)	—	—	H7A2	G5P	●	●	○	—	—		
		Connector	No	2 wire	12V	—	H7B	—	●	●	○	—	—		
				—	—	—	H7C	—	●	●	●	●	—		
		Grommet	Yes	3 wire (NPN)	24V	5V, 12V	—	H7NW	G59W	●	●	○	—	IC	
				3 wire (PNP)	—	—	H7PW	G5PW	●	●	○	—	—		
				2 wire	12V	—	H7BW	K59W	●	●	○	—	—		
				2 wire	12V	—	H7BA	G5BA	—	●	○	—	—		
				3 wire (NPN)	5V, 12V	—	—	G5NT	—	●	○	—	IC		
		Grommet	No	4 wire (NPN)	—	—	H7NF	G59F	●	●	○	—	—		
—	—			—	H7LF	—	●	●	○	—	—				

\* Lead wire length 0.5m.....— 3m.....L e.g.) C73C 5m.....Z e.g.) C73CZ C73CL None.....N C73CN

\* Solid state switches marked with "○" are manufactured upon receipt of order.

# Standard: Single Acting Spring Return/Extend *Series CG1*



Spring return



Spring extend

## Specifications

Action	Single acting/Spring return	Single acting/Spring extend
Bore size (mm)	20, 25, 32, 40	
Lubrication	Non-lube	
Fluid	Air	
Proof pressure	1.5MPa	
Max. operating pressure	1.0MPa	
Min. operating pressure	0.18MPa	0.23MPa
Ambient and fluid temperature	Without auto switch: -10°C to +70°C (No freezing)	
	With auto switch: -10°C to +60°C (No freezing)	
Piston speed	50 to 1000mm/s	
Stroke tolerance	Up to 200 <sup>+1.4</sup> <sub>0</sub> mm	
Thread tolerance	JIS class 2	
Cushion	Rubber bumper	
Mounting	Basic, Axial foot, Front flange, Rear flange, Front trunnion, Rear trunnion, Clevis (Used for changing the port location by 90° degrees.)	

CJ1

CJP

CJ2

CM2

C85

C76

CG1

MB

MB1

CP95

C95

C92

CA1

CS1

## Accessories

Mounting		Basic	Axial foot	Front flange	Rear flange	Front trunnion	Rear trunnion	Clevis
Standard	Rod end nut	●	●	●	●	●	●	●
	Clevis pin	—	—	—	—	—	—	●
Option	Single knuckle joint	●	●	●	●	●	●	●
	Double knuckle joint* (with pins)	●	●	●	●	●	●	●
	Pivot bracket	—	—	—	—	●	●	●

\* Pins and snap rings for double knuckle joint are included, not mounted.

## JIS symbol

### Spring return

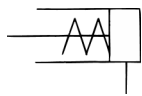

### Spring extend

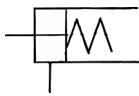

## Order Made Made to Order

Refer to p.5.4-1 for made to order products of series CG1.

## Stroke

Bore size (mm)	Standard stroke (mm) (1)
20	25, 50, 75, 100, 125
25, 32, 40	25, 50, 75, 100, 125, 150, 200

Note 1) Other intermediate strokes can be manufactured upon receipt of order. Spacers are not used for the intermediate strokes.

## Mounting Bracket Part No.

Mounting bracket	Bore size (mm)			
	20	25	32	40
Axial foot*	CG-L020	CG-L025	CG-L032	CG-L040
Flange	CG-F020	CG-F025	CG-F032	CG-F040
Trunnion pin	CG-T020	CG-T025	CG-T032	CG-T040
Clevis**	CG-D020	CG-D025	CG-D032	CG-D040
Pivot bracket	CG-020-24A	CG-025-24A	CG-032-24A	CG-040-24A

\* Order two foot brackets per a cylinder.

\*\* Mounting bolts are attached for foot and flange styles, and clevis pins, snap rings and mounting bolts for the clevis style.

## Auto Switch Mounting Bracket Part No.

Auto switch model	Bore size (mm)			
	20	25	32	40
D-C7-C8	BMA2-020	BMA2-025	BMA2-032	BMA2-040
D-H7				
D-B5-B6	BA-01	BA-02	BA-32	BA-04
D-G5-K5				



Note) A set of following stainless steel mounting screws is attached.  
(A switch mounting band is not attached. Please order the band separately.)

BBA3: D-B5/B6/G5 types

BBA4: D-C7/C8/H7 types

"D-G5BAL" and "D-H7BAL" switches are set on the cylinder with the screws above when shipped.

When a switch only is shipped, "BBA3" or "BBA4" screws are attached.



## Precautions

Be sure to read before handling.  
Refer to p.0-39 to 0-43 for Safety Instructions and common precautions.  
Refer to p.1.7-6 for precautions for series CG1.

# Series CG1

## Weight

(kg)

### Spring return

Bore size (mm)		20	25	32	40
Basic weight	25st	0.17	0.27	0.40	0.63
	50st	0.19	0.30	0.45	0.71
	75st	0.26	0.40	0.58	0.91
	100st	0.28	0.43	0.62	0.99
	125st	0.35	0.53	0.76	1.20
	150st	—	0.56	0.81	1.28
	200st	—	0.69	0.98	1.56
Mounting bracket weight	Axial foot	0.11	0.13	0.16	0.22
	Flange	0.08	0.10	0.14	0.20
	Trunnion	0.01	0.02	0.03	0.05
	Clevis	0.05	0.08	0.15	0.23
Accessory	Pivot bracket	0.08	0.09	0.17	0.25
	Single knuckle joint	0.05	0.09	0.09	0.10
	Double knuckle joint (with pins)	0.05	0.09	0.09	0.13

Calculation example: **CG1LN20-100S** (Foot, ø20, 100 stroke)

• Basic weight..... 0.28kg (ø20) • Mounting bracket weight.....0.11kg (Foot)  
0.28+0.11=0.39kg

### Spring extend

Bore size (mm)		20	25	32	40
Basic weight	25st	0.16	0.25	0.38	0.59
	50st	0.18	0.28	0.43	0.67
	75st	0.24	0.37	0.54	0.83
	100st	0.26	0.40	0.58	0.91
	125st	0.32	0.48	0.69	1.08
	150st	—	0.50	0.72	1.12
	200st	—	0.63	0.89	1.40
Mounting bracket weight	Axial foot	0.11	0.13	0.16	0.22
	Flange	0.08	0.10	0.14	0.20
	Trunnion	0.01	0.02	0.03	0.05
	Clevis	0.05	0.08	0.15	0.23
Accessory	Pivot bracket	0.08	0.09	0.17	0.25
	Single knuckle joint	0.05	0.09	0.09	0.10
	Double knuckle joint (with pins)	0.05	0.09	0.09	0.13

Calculation example: **CG1LN20-100T** (Foot, ø20, 100 stroke)

• Basic weight.....0.26kg (ø20) • Mounting bracket weight.....0.11kg (Foot)  
0.28+0.11=0.39kg

## Construction

### Single acting/Spring return

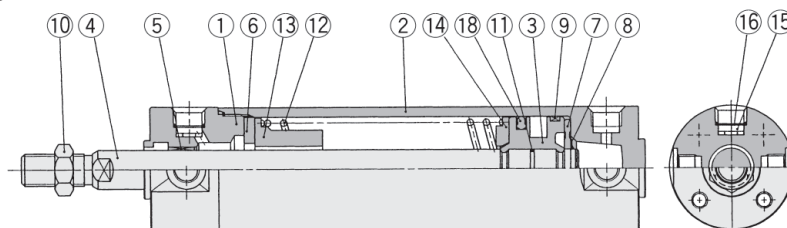

### Single acting/Spring

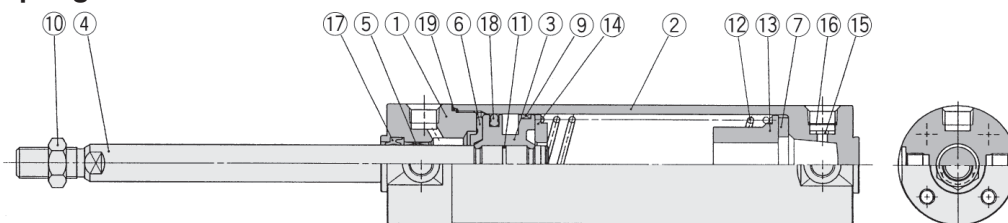

### Component Parts

No.	Description	Material	Note
①	Rod cover	Aluminum alloy	White hard anodized
②	Tube cover	Aluminum alloy	White hard anodized
③	Piston	Aluminum alloy	Chromated
④	Piston rod*	Carbon steel	Hard chrome plated
⑤	Bushing	Oil impregnated sintered alloy	ø40 or larger: Lead bronze cast
⑥	Bumper A	Urethane	
⑦	Bumper B	Urethane	
⑧	Snap ring	Stainless steel	
⑨	Wear ring	Resin	
⑩	Rod end nut	Rolled steel	Nickel plated
⑪	Piston gasket	NBR	
⑫	Return spring	Steel wire	Zinc chromated
⑬	Spring guide	Aluminum alloy	Chromated
⑭	Spring seat	Aluminum alloy	Chromated
⑮	Element	Sintered metal BC	
⑯	Snap ring	Steel wire	

Note) A rubber magnet is equipped on the piston of the cylinder with auto switch.

\* The material is stainless steel on auto switch equipped styles ø20 and ø25.

### Replacement Parts: Single acting/Spring return

No.	Description	Material	Bore size (mm)/Part No.			
			20	25	32	40
⑱	Piston seal	NBR	PPD-20	PPD-25-19	PPD-32	PPD-40

### Single acting/Spring extend (⑰ is the same as the spring return style.)

No.	Description	Material	Bore size (mm)/Part No.			
			20	25	32	40
⑰	Rod seal	NBR	PDU-8Z	PDU-10Z	PDU-12LZ	PDU-16Z
⑲	Tube gasket	NBR	CM-020-16-123	CM-025-16-124	CM-032-16-126	CM-040-16-127

## Auto Switch Mounting Position and Mounting Height

**D-C7, D-C8**

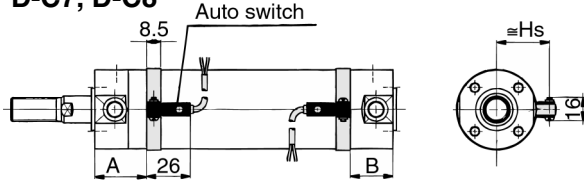

**D-G5, D-K5, D-G5□W, D-G5BAL  
D-K59W, D-G59F, D-G5NTL**

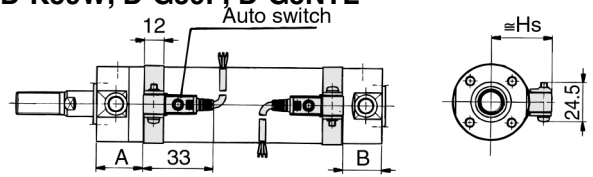

**D-H7, D-H7□W  
D-H7□F, D-H7BAL**

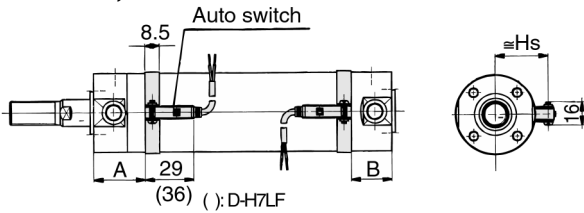

**D-C73C, D-C80C**

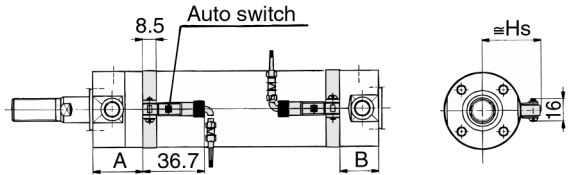

**D-B5, D-B6, D-B59W**

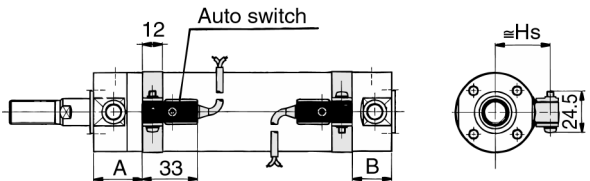

**D-H7C**

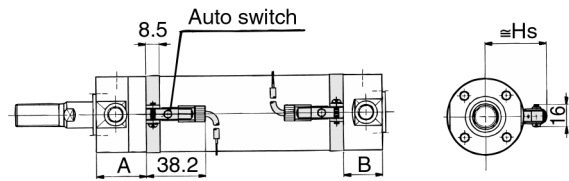

**Single acting/Spring return**

Auto switch model	Bore size	A							B All strokes	Hs
		25	50	75	100	125	150	200		
D-C7	20	55	55	80	80	105	—	—	20.5	24.5 (27)
D-C8	25	55	55	80	80	105	130	130	20.5	27 (29.5)
D-C73C	32	56	56	81	81	106	131	131	21.5	30.5 (33)
D-C80C	40	60.5	60.5	85.5	85.5	110.5	135.5	135.5	24	35 (37.5)
D-H7□	25	54	54	79	79	104	—	—	19.5	24.5 (27.5)
D-H7C	32	55	55	80	80	105	130	130	20.5	30.5 (33.5)
D-H7C	40	59.5	59.5	84.5	84.5	109.5	134.5	134.5	23	35 (38)
D-B5 D-B6 D-G50W D-K59W D-G59F D-G5BA	20	49	49	74	74	99	—	—	15	27.5
	25	49	49	74	74	99	124	124	15	30
	32	50	50	75	75	100	125	125	15.5	33.5
	40	54.5	54.5	79.5	79.5	104.5	129.5	129.5	18	38
D-G5 D-K5 D-G5NT	20	50.5	50.5	75.5	75.5	100.5	—	—	16	27.5
	25	50.5	50.5	75.5	75.5	100.5	125.5	125.5	16	30
	32	51.5	51.5	76.5	76.5	101.5	126.5	126.5	17	33.5
	40	56	56	81	81	106	131	131	19.5	38
D-B59W	20	52	52	77	77	102	—	—	17.5	27.5
	25	52	52	77	77	102	127	127	17.5	30
	32	53	53	78	78	103	128	128	18.5	33.5
	40	57.5	57.5	82.5	82.5	107.5	132.5	132.5	21	38
D-H7□W D-H7□F D-H7BA	20	52.5	52.5	77.5	77.5	102.5	—	—	18	24.5
	25	52.5	52.5	77.5	77.5	102.5	127.5	127.5	18	27
	32	53.5	53.5	78.5	78.5	103.5	128.5	128.5	19	30.5
	40	58	58	83	83	108	133	133	21.5	35

( ): With connector

**Single acting/Spring extend**

Auto switch model	Bore size	A All strokes	B							Hs
			25	50	75	100	125	150	200	
D-C7	20	30	45.5	45.5	70.5	70.5	95.5	—	—	24.5 (27)
D-C8	25	30	45.5	45.5	70.5	70.5	95.5	120.5	120.5	27 (29.5)
D-C73C	32	31	46.5	46.5	71.5	71.5	96.5	121.5	121.5	30.5 (33)
D-C80C	40	35.5	49	49	74	74	99	124	124	35 (37.5)
D-H7□	20	29	44.5	44.5	69.5	69.5	94.5	—	—	24.5 (27.5)
D-H7C	25	29	44.5	44.5	69.5	69.5	94.5	119.5	119.5	27 (30)
D-H7C	32	30	45.5	45.5	70.5	70.5	95.5	120.5	120.5	30.5 (33.5)
D-H7C	40	34.5	48	48	73	73	98	123	123	35 (38)
D-B5 D-B6 D-G50W D-K59W D-G59F D-G5BA	20	24	40	40	65	65	90	—	—	27.5
	25	24	40	40	65	65	90	115	115	30
	32	25	40.5	40.5	65.5	65.5	90.5	115.5	115.5	33.5
	40	29.5	43	43	68	68	93	118	118	38
D-G5 D-K5 D-G5NT	20	25.5	41	41	66	66	91	—	—	27.5
	25	25.5	41	41	66	66	91	116	116	30
	32	26.5	42	42	67	67	92	117	117	33.5
	40	31	44.5	44.5	69.5	69.5	94.5	119.5	119.5	38
D-B59W	20	27	42.5	42.5	67.5	67.5	92.5	—	—	27.5
	25	27	42.5	42.5	67.5	67.5	92.5	117.5	117.5	30
	32	28	43.5	43.5	68.5	68.5	93.5	118.5	118.5	33.5
	40	32.5	46	46	71	71	96	121	121	38
D-H7□W D-H7□F D-H7BA	20	27.5	43	43	68	68	93	—	—	24.5
	25	27.5	43	43	68	68	93	118	118	27
	32	28.5	44	44	69	69	94	119	119	30.5
	40	33	46.5	46.5	71.5	71.5	96.5	121.5	121.5	35

( ): With connector

- CJ1
- CJP
- CJ2
- CM2
- C85
- C76
- CG1**
- MB
- MB1
- CP95
- C95
- C92
- CA1
- CS1

# Series CG1

## Basic

### Spring return/CG1BN

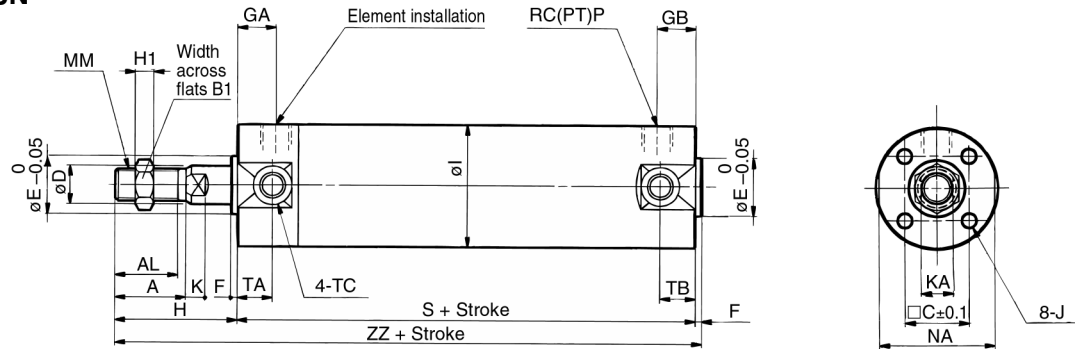

### Spring extend/CG1BN

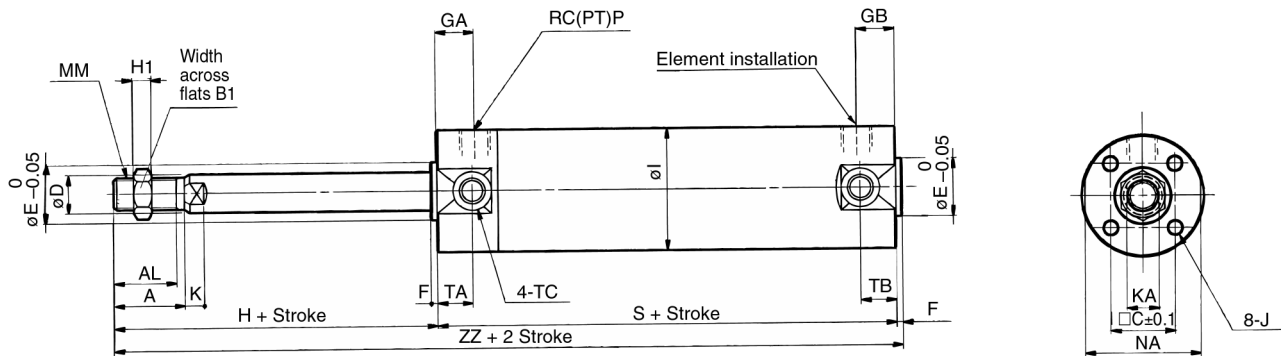

(mm)

Bore (mm)	Stroke range (mm)	A	AL	B1	C	D	E	F	GA	GB	H	H1	I	J	K	KA	MM	NA	P
20	Up to 125	18	15.5	13	14	8	12	2	12	10	35	5	26	M4 Depth 7	5	6	M8	24	1/8
25	Up to 200	22	19.5	17	16.5	10	14	2	12	10	40	6	31	M5 Depth 7.5	5.5	8	M10 X 1.25	29	1/8
32	Up to 200	22	19.5	17	20	12	18	2	12	10	40	6	38	M5 Depth 8	5.5	10	M10 X 1.25	35.5	1/8
40	Up to 200	30	27	19	26	16	25	2	13	10	50	8	47	M6 Depth 12	6	14	M14 X 1.5	44	1/8

Bore (mm)	TA	TB	TC	1 to 50st		51 to 100st		101 to 125st		126 to 200st	
				S	ZZ	S	ZZ	S	ZZ	S	ZZ
20	11	11	M5	94	131	119	156	144	181	—	—
25	11	11	M6 X 0.75	94	136	119	161	144	186	169	211
32	11	10	M8 X 1.0	96	138	121	163	146	188	171	213
40	12	10	M10 X 1.25	103	155	128	180	153	205	178	230

### With Mounting Bracket



Note) The drawing below shows the single acting/spring return style.  
The rod is retracted in case of the spring extend style

### Axial foot/CG1LN

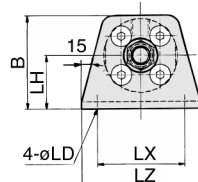
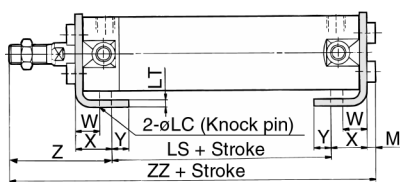

### Axial foot

(mm)

Bore (mm)	Stroke range (mm)	B	M	LC	LD	LH	LT	LX	LZ	W	X	Y	Z
20	Up to 125	34	3	4	6	20	3	32	44	10	15	7	47
25	Up to 200	38.5	3.5	4	6	22	3	36	49	10	15	7	52
32	Up to 200	45	3.5	4	6.6	25	3	44	58	10	16	8	53
40	Up to 200	54.5	4	4	6.6	30	3	54	71	10	16.5	8.5	63.5

Bore (mm)	1 to 50st		51 to 100st		101 to 125st		126 to 200st	
	LS	ZZ	LS	ZZ	LS	ZZ	LS	ZZ
20	70	135	95	160	120	185	—	—
25	70	140.5	95	165.5	120	190.5	145	215.5
32	70	142.5	95	167.5	120	192.5	145	217.5
40	76	160	101	185	126	210	151	235



# Standard: Single Acting Spring Return/Extend *Series CG1*

## With Mounting Bracket

### Front flange/CG1FN

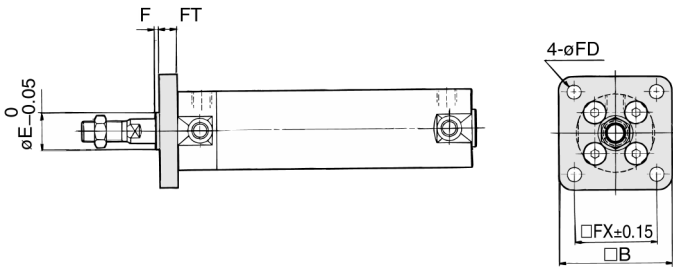

(mm)							
Bore size (mm)	Stroke range (mm)	B	E	F	FX	FD	FT
20	Up to 125	40	12	2	28	5.5	6
25	Up to 200	44	14	2	32	5.5	7
32	Up to 200	53	18	2	38	6.6	7
40	Up to 200	61	25	2	46	6.6	8

\* End boss is machined on the flange for øE.

### Rear flange/CG1GN

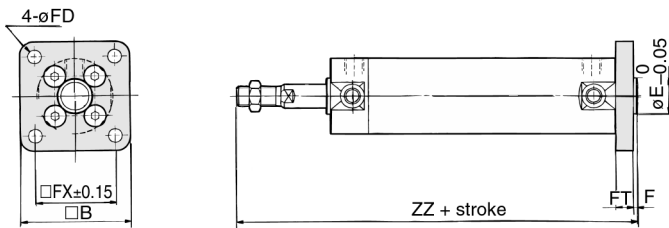

### Front flange (mm)

Bore size (mm)	ZZ			
	1 to 50st	51 to 100st	101 to 125st	126 to 200st
20	131	156	181	—
25	136	161	186	211
32	138	163	188	213
40	155	180	205	230

### Rear flange (mm)

Bore size (mm)	ZZ			
	1 to 50st	51 to 100st	101 to 125st	126 to 200st
20	137	162	187	—
25	143	168	193	218
32	145	170	195	220
40	163	188	213	238

### Front trunnion/CG1UN

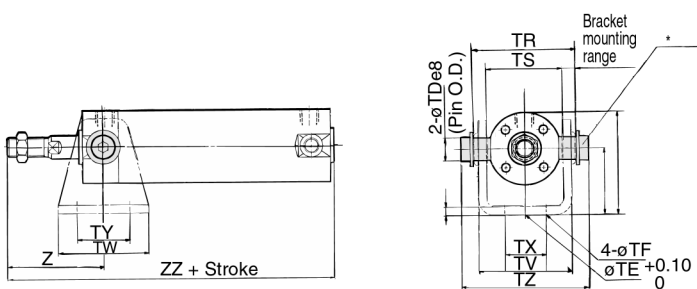

(mm)														
Bore size (mm)	Stroke range (mm)	B	TDe8	TE	TF	TH	TR	TS	TT	TV	TW	TX	TY	TZ
20	Up to 125	38	8 <sup>-0.025</sup> <sub>-0.047</sub>	10	5.5	25	39	28	3.2	35.8	42	16	28	47.6
25	Up to 200	45.5	10 <sup>-0.025</sup> <sub>-0.047</sub>	10	5.5	30	43	33	3.2	39.8	42	20	28	53
32	Up to 200	54	12 <sup>-0.032</sup> <sub>-0.059</sub>	10	6.6	35	54.5	40	4.5	49.4	48	22	28	67.7
40	Up to 200	63.5	14 <sup>-0.032</sup> <sub>-0.059</sub>	10	6.6	40	65.5	49	4.5	58.4	56	30	30	78.7

\* Consists of pins, flat washer and hexagon socket head cap bolt.

### Front trunnion (mm)

Bore size (mm)	Z	ZZ			
		1 to 50st	51 to 100st	101 to 125st	126 to 200st
20	46	131	156	181	—
25	51	136	161	186	211
32	51	138	163	188	213
40	62	155	180	205	230

### Rear trunnion (mm)

Bore size (mm)	1 to 50st		51 to 100st		101 to 125st		126 to 200st	
	Z	ZZ	Z	ZZ	Z	ZZ	Z	ZZ
20	118	139	143	164	168	189	—	—
25	123	144	148	169	173	194	198	219
32	126	150	151	175	176	200	201	225
40	143	171	168	196	193	221	218	246

### Rear trunnion/CG1TN

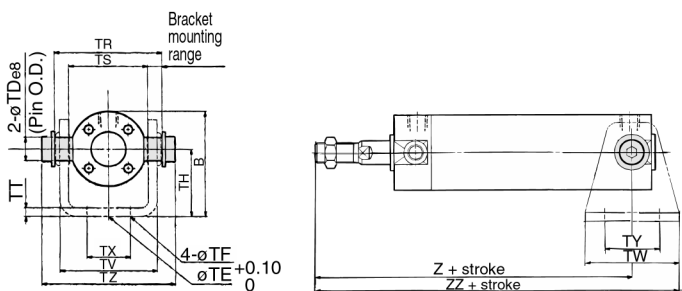

### Clevis (mm)

Bore size (mm)	Stroke range (mm)	B	CD	CZ	L	RR	TE	TF	H	TT	TV
20	Up to 125	38	8	29	14	11	10	5.5	25	3.2	35.8
25	Up to 200	45.5	10	33	16	13	10	5.5	30	3.2	39.8
32	Up to 200	54	12	40	20	15	10	6.6	35	4.5	49.4
40	Up to 200	63.5	14	49	22	18	10	6.6	40	4.5	58.4

### Clevis/CG1DN

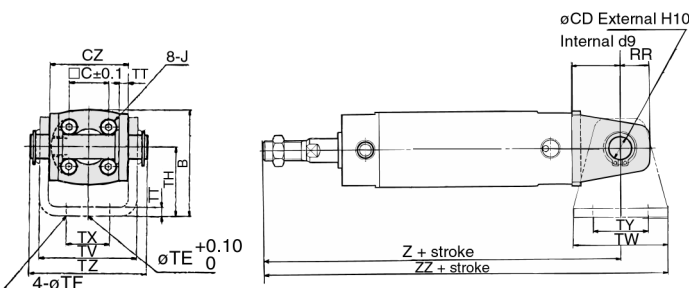

Bore size (mm)	TW	TX	TY	TZ	1 to 50st		51 to 100st		101 to 125st		126 to 200st	
					Z	ZZ	Z	ZZ	Z	ZZ	Z	ZZ
20	42	16	28	43.4	143	164	168	189	193	214	—	—
25	42	20	28	48	150	171	175	196	200	221	225	246
32	48	22	28	59.4	156	180	181	205	206	230	231	255
40	56	30	30	71.4	175	200	200	228	225	253	250	278

\* Refer to p.1.7-11 for dimensions of the pivot bracket.

(The above shows the case port location is changed by 90 degrees.)

CJ1

CJP

CJ2

CM2

C85

C76

**CG1**

MB

MB1

CP95

C95

C92

CA1

CS1

# Non-rotating Rod: Double Acting

# Series CG1K

ø20, ø25, ø32, ø40, ø50, ø63

## How to Order

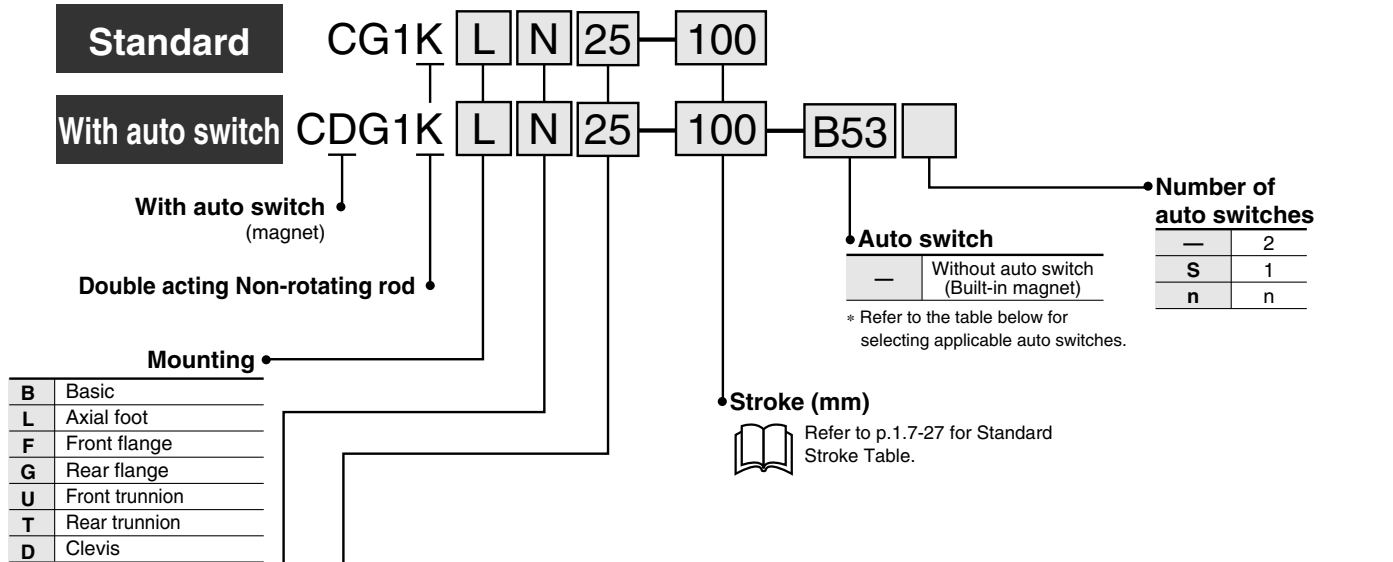

### Applicable Auto Switches/ Refer to p.5.3-2 for further information on auto switch.

Style	Special function	Electrical entry	Indicator	Wiring (Output)	Load voltage		Auto switch model		Lead wire (m)*				Applicable load
					DC	AC	0.5 (-)	3 (L)	5 (Z)	None (N)			
Reed switch	—	Grommet	Yes	3 wire (NPN)	—	5V	—	C76	●	●	—	—	IC
								B53	●	●	●	—	PLC
								B54	●	●	—	—	—
								B64	●	—	—	—	—
								C73	●	●	—	—	—
								C80	●	—	—	—	IC
Solid state switch	—	Grommet	Yes	3 wire (NPN)	—	5V, 12V	—	H7A1	●	●	○	—	IC
								G59	●	●	—	—	
								H7A2	●	●	○	—	IC
								G5P	●	—	—	—	
								H7B	●	●	○	—	—
								K59	●	—	—	—	
								H7C	●	●	●	—	—
								H7NW	●	●	○	—	IC
								G59W	●	●	—	—	
								H7PW	●	●	○	—	IC
								G5PW	●	—	—	—	
								H7BW	●	●	○	—	—
K59W	●	—	—	—									
H7BA	—	●	○	—	—								
G5BA	—	●	—	—									
—	—	●	○	—	IC								
G5NT	—	●	—	—									
H7NF	●	●	○	—	—								
G59F	●	—	—	—									
H7LF	—	●	○	—	—								

\*Lead wire length 0.5m..... — 3m.....L e.g.) C73C 5m.....Z C73CL None.....N e.g.) C73CZ C73CN

\*Solid state switches marked with "○" are manufactured upon receipt of order.

### Mounting Bracket Part No.

Mounting bracket	Bore size (mm)					
	20	25	32	40	50	63
Axial foot*	CG-L020	CG-L025	CG-L032	CG-L040	CG-L050	CG-L063
Flange	CG-F020	CG-F025	CG-F032	CG-F040	CG-F050	CG-F063
Trunnion pin	CG-T020	CG-T025	CG-T032	CG-T040	CG-T050	CG-T063
Clevis**	CG-D020	CG-D025	CG-D032	CG-D040	CG-D050	CG-D063
Pivot bracket	CG-020-24A	CG-025-24A	CG-032-24A	CG-040-24A	CG-050-24A	CG-063-24A

\* Order two foot brackets per a cylinder.

\*\* Mounting bolts are attached for foot and flange styles, and clevis pins, snap rings and mounting bolts for the clevis style.

### Auto Switch Mounting Bracket Part No.

Auto switch model	Bore size (mm)					
	20	25	32	40	50	63
D-C7-C8	BMA2-020	BMA2-025	BMA2-032	BMA2-040	BMA2-050	BMA2-063
D-H7						
D-B5-B6	BA-01	BA-02	BA-32	BA-04	BA-05	BA-06
D-G5-K5						

Note) A set of following stainless steel mounting screws is attached. (A switch mounting band is not attached. Please order the band separately.)

BBA3: D-B5/B6/G5 types

BBA4: D-C7/C8/H7 types

"D-G5BAL" and "D-H7BAL" switches are set on the cylinder with the screws above when shipped.

When a switch only is shipped, "BBA3" or "BBA4" screws are attached.

# Non-rotating Rod: Double Acting *Series CG1K*

## High non-rotating accuracy

$\phi 20, \phi 25$  —————  $\pm 1^\circ$   
 $\phi 32$  —————  $\pm 0.8^\circ$   
 $\phi 40$  to  $\phi 63$  —————  $\pm 0.5^\circ$

## High speed operation/Long life

Piston speed is between 50 and 500mm/s and long life is expected.

## Can operate without lubrication.

## The same installation dimensions as the standard cylinder.

## Auto switches can also be mounted.

It can be installed with auto switches to simplify the detection of the stroke position of the cylinder.



## JIS symbol

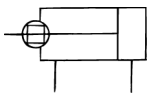

**Order Made** Made to Order

Refer to p.5.4-1 for made to order products of series CG1K.

## With auto switch

Auto switches can be mounted. Mounting position/height is the same as the double acting/single rod style. Refer to p.1.7-13.

## Specifications

Bore size (mm)	20	25	32	40	50	63
Action	Double acting/Single rod					
Lubrication	Non-lube					
Fluid	Air					
Proof pressure	1.5MPa					
Max. operating pressure	1.0MPa					
Min. operating pressure	0.05MPa					
Ambient and fluid temperature	Without auto switch: $-10^\circ\text{C}$ to $+70^\circ\text{C}$ (No freezing)					
	With auto switch: $-10^\circ\text{C}$ to $+60^\circ\text{C}$ (No freezing)					
Piston speed	50 to 500mm/s					
Thread tolerance	JIS class 2					
Stroke tolerance	Up to $600^{+1.4}_0$ mm					
Cushion	Rubber bumper, Air cushion ( $\phi 40$ to $\phi 63$ only)					
Rod non-rotating accuracy	$\pm 1^\circ$	$\pm 0.8^\circ$	$\pm 0.5^\circ$			
Mounting	Basic, Axial foot, Front flange, Rear flange, Front trunnion, Rear trunnion, Clevis (Used for changing the port location by $90^\circ$ degrees.)					

## Accessories

Mounting		Basic	Axial foot	Front flange	Rear flange	Front trunnion	Rear trunnion	Clevis
Standard	Rod end nut	●	●	●	●	●	●	●
	Clevis pin	—	—	—	—	—	—	●
Option	Single knuckle joint	●	●	●	●	●	●	●
	Double knuckle joint* (with pins)	●	●	●	●	●	●	●
	Pivot bracket	—	—	—	—	●	●	●

\* Pins and snap rings for double knuckle joint are attached, not mounted.

## Stroke

Bore size (mm)	Standard stroke <sup>(1)</sup> (mm)	Long stroke (mm)
20	25, 50, 75, 100, 125, 150, 200	—
25	25, 50, 75, 100, 125, 150, 200, 250, 300	—
32		—
40		301 to 500
50/63		301 to 600



Note 1) Other intermediate strokes can be manufactured upon receipt of order. Spacers are not used for the intermediate strokes.

Note 2) The maximum limit is 1500 stroke, but the products that exceed the standard or the long stroke limit are not guaranteed.

CJ1

CJP

CJ2

CM2

C85

C76

CG1

MB

MB1

CP95

C95

C92

CA1

CS1

# Series CG1K

## Weight

		(kg)					
Bore size (mm)		20	25	32	40	50	63
Basic weight	Basic	0.10	0.17	0.26	0.41	0.77	1.07
	Axial foot	0.21	0.30	0.42	0.63	1.25	1.79
	Flange	0.18	0.27	0.40	0.61	1.11	1.57
	Trunnion	0.11	0.19	0.29	0.46	0.91	1.21
	Clevis	0.15	0.25	0.41	0.64	1.17	1.75
Pivot bracket		0.08	0.09	0.17	0.25	0.44	0.80
Single knuckle joint		0.05	0.09	0.09	0.10	0.22	0.22
Double knuckle joint (with pins)		0.05	0.09	0.09	0.13	0.26	0.26
Additional weight by each 50 stroke		0.05	0.07	0.09	0.15	0.22	0.26
Additional weight by air cushion		—	—	—	0.02	0.03	0.03
Additional weight by long stroke		—	—	—	0.03	0.06	0.10

Calculation example:  
**CGIKLN20-100**  
 (Foot, ø20, 100 stroke)

- Basic weight.....0.21 (Foot, ø20)
- Additional weight.....0.05/50 stroke
- Cylinder stroke.....100 stroke

$$0.21 + 0.05 \times 100/50 = 0.31\text{kg}$$

## Copper Free

20-CG1K Mounting N Bore size Stroke

• Copper free

This cylinder eliminates any influences of copper ions or fluororesins on colour CRTs. Copper materials have been nickel plated or replaced with non-copper materials to prevent the generation of copper ions.

## Specifications

Bore size (mm)	ø20, ø25, ø32, ø40, ø50, ø63
Action	Double acting
Fluid	Air
Max. operating pressure	1.0MPa
Min. operating pressure	0.05MPa
Piston speed	50 to 500mm/s
Mounting	Basic, Axial foot, Front flange, Rear flange, Front trunnion, Rear trunnion, Clevis (Used for changing the port location by 90° degrees.)

## Construction

### With rubber bumper

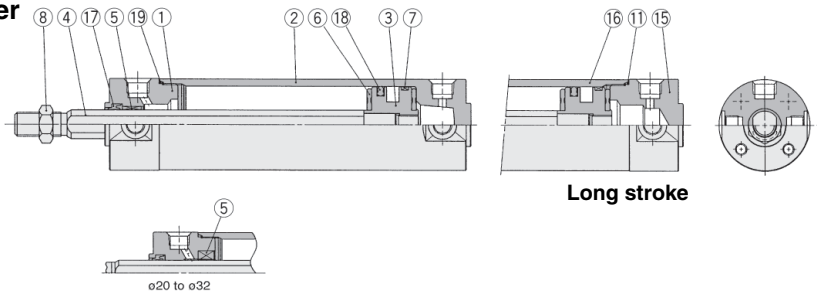

Long stroke

### With air cushion

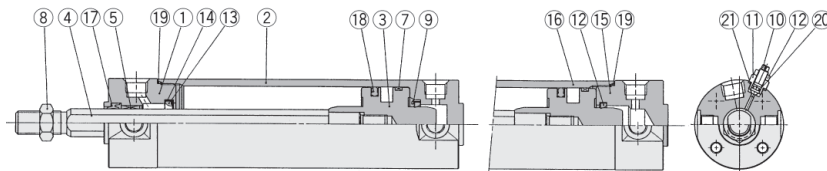

Long stroke

## Component Parts

No.	Description	Material	Note
①	Rod cover	Aluminum alloy	White hard anodized
②	Tube cover	Aluminum alloy	White hard anodized
③	Piston	Aluminum alloy	Chromated, Hard anodized (in case of air cushion)
④	Piston rod*	Carbon steel	Hard chrome plated
⑤	Non-rotating guide	Oil impregnated sintered alloy	
⑥	Bumper	Urethane	
⑦	Wear ring	Resin	
⑧	Rod end nut	Rolled steel	Nickel plated

No.	Description	Material	Note
⑨	Seal retainer	Rolled steel	Nickel plated (Except for long stroke)
⑩	Cushion valve	Rolled steel	Electroless nickel plated
⑪	Valve retainer	Rolled steel	Electroless nickel plated
⑫	Lock nut	Carbon steel	Nickel plated
⑬	Cushion seal	NBR	
⑭	Cushion seal holder	Aluminum alloy	
⑮	Head cover	Aluminum alloy	White hard anodized
⑯	Cylinder tube	Aluminum alloy	Hard anodized

## Replacement Parts/With rubber bumper

No.	Description	Material	Bore size (mm)/Part No.					
			ø20	ø25	ø32	ø40	ø50	ø63
⑰	Rod seal	NBR	SS-9 X 8k2Q	SS-11 X 10k2	SS-12	SS-16S	SS-20S	SS-20S
⑱	Piston seal	NBR	PPD-20	PPD-25-19	PPD-32	PPD-40	PPD-50	PPD-63
⑲	Tube gasket	NBR	CM-020-16-123	CM-025-16-124	CM-032-16-126	CM-040-16-127	CM-050-16-128	CM-063-16-129

Note) A rubber magnet is equipped on the piston of the cylinder with auto switch.  
 \* The material is stainless steel on ø20 to ø32.

## With air cushion (Parts ⑰ to ⑲ are the same as rubber bumper style.)

⑳	Valve seal	NBR	—	—	—	O ring ø4.5 X ø2.5 X ø1	O ring ø5.5 X ø3.5 X ø1
㉑	Valve retaining gasket	NBR	—	—	—	O ring ø6.4 X ø5.2 X ø0.6	O ring ø7.4 X ø5.8 X ø0.8

## Basic

### With rubber bumper/CG1KBN ø20 to ø63

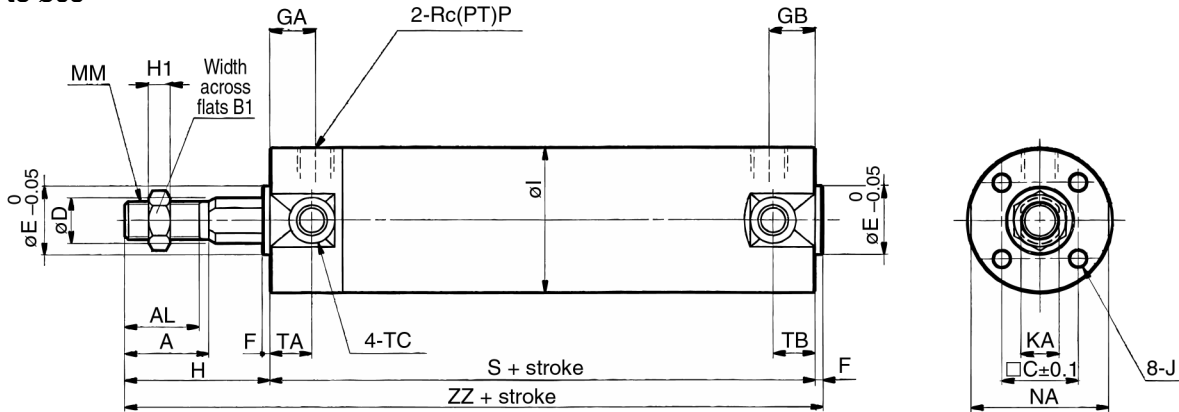

### With air cushion/CG1KBA ø40 to ø63

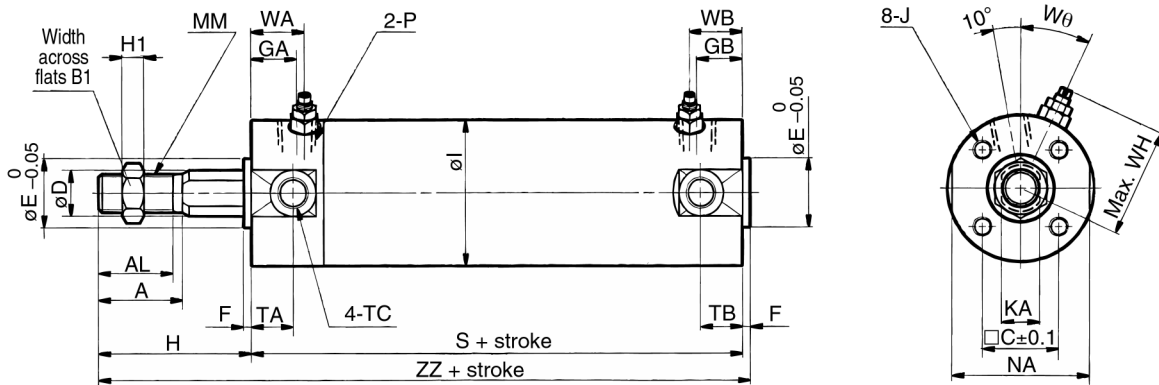

Bore (mm)	Stroke range (mm)	A	AL	B1	C	D	E	F	GA	GB	H	H1	I	J	KA	MM	NA	P	S	TA	TB	TC	ZZ
20	Up to 200	18	15.5	13	14	9.2	12	2	12	10	35	5	26	M4 Depth 7	8	M8	24	1/8	69	11	11	M5	106
25	Up to 300	22	19.5	17	16.5	11	14	2	12	10	40	6	31	M5 Depth 7.5	10	M10 X 1.25	29	1/8	69	11	11	M6 X 0.75	111
32	Up to 300	22	19.5	17	20	12	18	2	12	10	40	6	38	M5 Depth 8	10	M10 X 1.25	35.5	1/8	71	11	10	M8 X 1.0	113
40	Up to 300 (500)	30	27	19	26	16	25	2	13	10 (13)	50	8	47	M6 Depth 12	14	M14 X 1.5	44	1/8	78 (87)	12	10 (12)	M10 X 1.25	130 (139)
50	Up to 300 (600)	35	32	27	32	20	30	2	14	12 (14)	58	11	58	M8 Depth 16	18	M18 X 1.5	55	1/4	90 (102)	13	12 (13)	M12 X 1.25	150 (162)
63	Up to 300 (600)	35	32	27	38	20	32	2	14	12 (14)	58	11	72	M10 Depth 16	18	M18 X 1.5	69	1/4	90 (102)	13	12 (13)	M14 X 1.5	150 (162)

Note 1) Dimensions for each mounting bracket are the same as those for CG1 standard or long stroke model. Refer to p.1.7-8 to 1.7-10. Also, refer to p.1.7-12 for auto switch equipped style.  
 Note 2) ( ): Long stroke

### With air cushion

Bore (mm)	P	WA	WB	WH	Wθ
40	Rc (PT) 1/8	16	15 (16)	33	20°
50	Rc (PT) 1/4	18	17 (18)	40.5	20°
63	Rc (PT) 1/4	18	17 (18)	47.5	20°

Note) ( ): Long stroke

## ⚠ Precautions

Be sure to read before handling. Refer to p.0-39 to 0-46 for Safety Instruction and common precautions.

### Handling

#### ⚠ Cautions

- Ⓛ Avoid using the air cylinder in such a way that rotational torque would be applied to the piston rod.
- If rotational torque is applied, the non-rotating guide will become deformed. Refer to the table below for the allowable range of rotational torque.

Allowable rotational torque (Nm)	ø20	ø25/ø32	ø40/ø50/ø63
	0.2	0.25	0.44

- To screw a bracket or a nut onto the piston rod, make sure to retract the piston rod entirely, and place a wrench over the flat portion of the rod that protrudes.

To tighten, take precautions to prevent the tightening torque from being applied to the non-rotating guide.

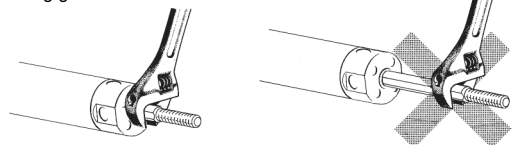

- Ⓛ To replace a rod seal, contact SMC.

A rod seal could lead to an air leak, depending on the position in which it is fitted. Therefore, make sure to contact SMC if a rod seal must be replaced.

- CJ1
- CJP
- CJ2
- CM2
- C85
- C76
- CG1**
- MB
- MB1
- CP95
- C95
- C92
- CA1
- CS1

# Non-rotating Rod: Double Acting Double Rod

# Series CG1KW

ø20, ø25, ø32, ø40, ø50, ø63

## How to Order

**Standard** CG1KW L N 25 100

**With auto switch** CDG1KW L N 25 100 B53

With auto switch (magnet)  
Non-rotating rod  
Double acting/Double rod  
Mounting  
Cushion

**Auto switch**

—	Without auto switch (Built-in magnet)
---	---------------------------------------

\* Refer to the table below for selecting applicable auto switches.

—	2
S	1
n	n

**Stroke** → Refer to p.1.7-31 for Standard Stroke Table.

**Bore size**

20	20mm
25	25mm
32	32mm
40	40mm
50	50mm
63	63mm

**Mounting**

B	Basic
L	Axial foot
F	Front flange
U	Front trunnion

Note) Mounting brackets are included, not mounted.

**Cushion**

N	Rubber bumper
---	---------------

## Applicable Auto Switches/Refer to p.5.3-2 for further information on auto switch.

Style	Special function	Electrical entry	Indicator	Wiring (output)	Load voltage		Auto switch model		Lead wire (m)*				Applicable load										
					DC	AC			0.5 (-)	3 (L)	5 (Z)	None (N)											
Reed switch	—	Grommet	Yes	3 wire (NPN)	5V	—	C76	—	●	●	—	—	IC										
									24V	12V	200V or less	—		B53	●	●	●	—	PLC				
															100V	C73	●	●		●	—		
																	5V, 12V	100V or less		C80	●	●	—
															12V	—					C73C	●	●
									5V, 12V	24V or less	C80C	●		●			●	●	IC				
												Grommet		Yes	—	—	—	B59W		●	●	—	—
Solid state switch	—	Grommet	Yes	3 wire (NPN)	5V, 12V	—	H7A1	G59	●	●	○		—						IC				
									Connector	2 wire	12V	—	—	—	—	—	●	●		○	●	—	
																	3 wire (NPN)	5V, 12V		—	H7NW		G59W
									3 wire (PNP)	24V	—	H7PW	G5PW	●	●	○						—	
		Grommet	Yes	2 wire	12V	—	—	—						—	—	—	—	—					
									3 wire (NPN)	5V, 12V	—	H7BW	K59W						●	●	○	—	
		3 wire (PNP)	24V	—	H7BA	G5BA	—	●						○	—								
							Grommet	Yes	3 wire (NPN)	5V, 12V	—	—	G5NT	—	●	○	—	IC					
		Connector	4 wire (NPN)	—	—	—								—	—	—	—		—	—			
							Grommet	Yes	3 wire (NPN)	5V, 12V	—	—	—					—			—	—	—
		Connector	4 wire (NPN)	—	—	—								—	—	—	—		—	—			
							Grommet	Yes	3 wire (NPN)	5V, 12V	—	—	—					—			—	—	—
		Connector	4 wire (NPN)	—	—	—								—	—	—	—		—	—			

\* Lead wire length 0.5m.....— 3m.....L e.g.) C73C 5m.....Z None.....N e.g.) C73CZ C73CN

\* Solid state switches marked with "○" are manufactured upon receipt of order.

# Non-rotating Rod: Double Acting Double Rod *Series CG1KW*

## High non-rotating accuracy

$\phi 20, \phi 25$  —————  $\pm 1^\circ$   
 $\phi 32$  —————  $\pm 0.8^\circ$   
 $\phi 40$  to  $\phi 63$  —————  $\pm 0.5^\circ$

## High speed operation/Long life

Piston speed is between 50 and 500mm/s and long life is expected.

## Can operate without lubrication.

## The same installation dimensions as the standard cylinder.

## Auto switches can also be mounted.

It can be installed with auto switches to simplify the detection of the stroke position of the cylinder.



## JIS symbol

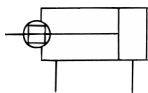

## Specifications

Bore size (mm)	20	25	32	40	50	63
Action	Double acting/Double rod					
Lubrication	Non-lube					
Fluid	Air					
Proof pressure	1.5MPa					
Max. operating pressure	1.0MPa					
Min. operating pressure	0.08MPa					
Ambient and fluid temperature	Without auto switch: $-10^\circ\text{C}$ to $+70^\circ\text{C}$ (No freezing)					
	With auto switch: $-10^\circ\text{C}$ to $+60^\circ\text{C}$ (No freezing)					
Piston speed	50 to 500mm/s					
Thread tolerance	JIS class 2					
Stroke tolerance	up to 600 $^{+1.4}_0$ mm					
Cushion	Rubber bumper					
Rod non-rotating accuracy	$\pm 1^\circ$	$\pm 0.8^\circ$	$\pm 0.5^\circ$			
Mounting	Basic, Axial foot, Front flange, Front trunnion					

## Accessories

Mounting		Basic	Axial foot	Front flange	Front trunnion
Standard	Rod end nut	●	●	●	●
Option	Single knuckle joint	●	●	●	●
	Double knuckle joint** (with pins)	●	●	●	●
	Pivot bracket	—	—	—	●*

\* Pins and snap rings for double knuckle joint are included, not mounted.

## Stroke

Bore size (mm)	Standard stroke (mm) <sup>(1)</sup>	Long stroke (mm)
20	25, 50, 75, 100, 125, 150, 200	—
25	25, 50, 75, 100, 125, 150, 200, 250, 300	—
32		—
40		301 to 500
50/63		301 to 600

Note 1) Other intermediate strokes can be manufactured upon receipt of order. Spacers are not used for the intermediate strokes.

Note 2) The maximum limit is 1500 stroke, but the products that exceed the standard or long stroke limit are not guaranteed.

## ⚠ Precautions

Be sure to read before handling.  
 Refer to p.0-39 to 0-46 for Safety Instruction and common precautions.  
 Refer to p.1.7-6 for precautions on series CG1K.

## With Auto Switch

Auto switch can be mounted. Refer to p.1.7-34 for details.

CJ1

CJP

CJ2

CM2

C85

C76

CG1

MB

MB1

CP95

C95

C92

CA1

CS1

# Series CG1KW

## Weight

(kg)

Bore size (mm)		20	25	32	40	50	63
Basic weight	Basic	0.13	0.22	0.33	0.55	1.02	1.37
	Axial foot*	0.24	0.35	0.49	0.77	1.50	2.09
	Flange	0.21	0.32	0.47	0.75	1.36	1.87
	Trunnion	0.14	0.24	0.36	0.60	1.16	1.51
Pivot bracket		0.08	0.09	0.17	0.25	0.44	0.80
Single knuckle joint		0.05	0.09	0.09	0.10	0.22	0.22
Double knuckle joint (with pins)		0.05	0.09	0.09	0.13	0.26	0.26
Additional weight by each 50 stroke		0.07	0.10	0.13	0.23	0.34	0.38

Calculation example: CG1KWLN32-100 (Foot, ø32, 100 stroke)

• Basic weight.....0.49 (Foot, ø32)

• Cylinder stroke.....100 stroke

• Additional weight.....0.13/50 stroke

0.49+0.13 X 100/50=0.75kg

## Mounting Bracket Part No.

Mounting bracket	Bore size (mm)					
	20	25	32	40	50	63
Axial foot*	CG-L020	CG-L025	CG-L032	CG-L040	CG-L050	CG-L063
Flange	CG-F020	CG-F025	CG-F032	CG-F040	CG-F050	CG-F063
Trunnion pin	CG-T020	CG-T025	CG-T032	CG-T040	CG-T050	CG-T063
Pivot bracket	CG-020 -24A	CG-025 -24A	CG-032 -24A	CG-040 -24A	CG-050 -24A	CG-063 -24A

\* Order two foot brackets per a cylinder.

\*\* Mounting bolts are attached for the foot style and the flange style.

## Auto Switch Mounting Bracket Part No.

Auto switch model	Bore size (mm)					
	20	25	32	40	50	63
D-C7-C8	BMA2 -020	BMA2 -025	BMA2 -032	BMA2 -040	BMA2 -050	BMA2 -063
D-H7						
D-B5-B6	BA-01	BA-02	BA-32	BA-04	BA-05	BA-06
D-G5-K5						

Note) A set of following stainless steel mounting screws is attached.

(A switch mounting band is not attached. Please order the band separately.)

BBA3: D-B5/B6/G5 types

BBA4: D-C7/C8/H7 types

"D-G5BAL" and "D-H7BAL" switches are set on the cylinder with the screws above when shipped.

When a switch only is shipped, "BBA3" or "BBA4" screws are attached.

## Construction

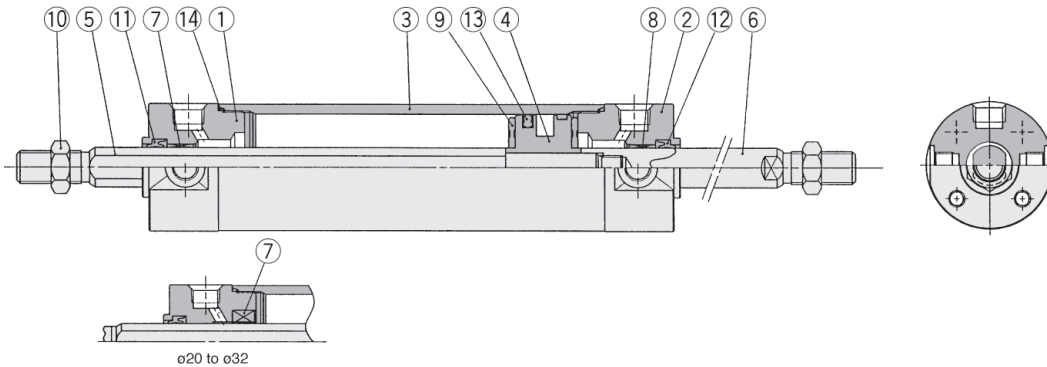

## Component Parts

No.	Description	Material	Note
①	Rod cover A	Aluminum alloy	White hard anodized
②	Rod cover B	Aluminum alloy	White hard anodized
③	Cylinder tube	Aluminum alloy	Hard anodized
④	Piston	Aluminum alloy	Chromated
⑤	Piston rod A	Carbon steel*	Hard chrome plated
⑥	Piston rod B	Carbon steel**	Hard chrome plated
⑦	Non-rotating guide	Oil impregnated sintered alloy	
⑧	Bushing	Oil impregnated sintered alloy	ø40 or larger: Lead bronze cast
⑨	Bumper	Urethane	
⑩	Rod end nut	Rolled steel	

\* The material is stainless steel for ø20 to ø32.

\*\* The material is stainless steel on auto switch equipped style ø20 and ø25.

\*\*\* A magnet is equipped on the piston of the cylinder with auto switch.

## Replacement Parts/With rubber bumper

No.	Description	Material	Bore size (mm)/Part No.					
			ø20	ø25	ø32	ø40	ø50	ø63
⑪	Rod seal A	NBR	PDU-8Z	PDU-10Z	PDU-12LZ	PDU-16Z	PDU-20Z	
⑫	Rod seal B	NBR	SS-9 X 8K2Q	SS-11 X 10K2	SS-12	SS-16S	SS-20S	
⑬	Piston seal	NBR	PPD-20	PPD-25-19	PPD-32	PPD-40	PPD-50	PPD-63
⑭	Tube gasket	NBR	CM-020-16-123	CM-025-16-124	CM-032-16-126	CM-040-16-127	CM-050-16-128	CM-063-16-129



# Non-rotating Rod: Double Acting Double Rod *Series CG1KW*

## Basic CG1KWBN: With rubber bumper

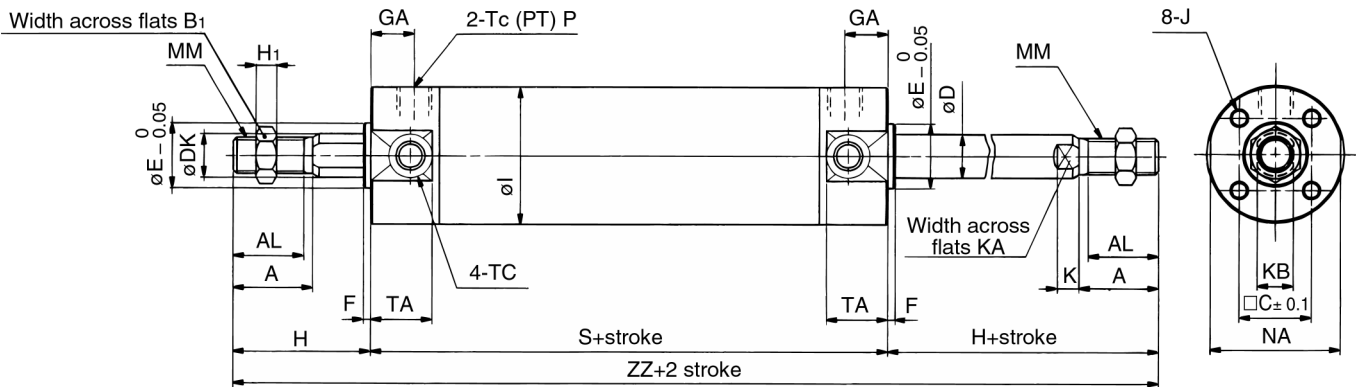

Bore (mm)	Stroke range (mm)	A	AL	B1	□C	D	DK	E	F	GA	H1	I	J	K	KA	KB	MM	NA	P	S
20	Up to 200	18	15.5	13	14	8	9.2	12	2	12	5	26	M4 Depth 7	5	6	8	M8	24	1/8	77
25	Up to 300	22	19.5	17	16.5	10	11	14	2	12	6	31	M5 Depth 7.5	5.5	8	10	M10 X 1.25	29	1/8	77
32	Up to 300	22	19.5	17	20	12	12	18	2	12	6	38	M5 Depth 8	5.5	10	10	M10 X 1.25	35.5	1/8	79
40	Up to 500	30	27	19	26	16	16	25	2	13	8	47	M6 Depth 12	6	14	14	M14 X 1.5	44	1/8	87
50	Up to 600	35	32	27	32	20	20	30	2	14	11	58	M8 Depth 16	7	18	18	M18 X 1.5	55	1/4	102
63	Up to 600	35	32	27	38	20	20	32	2	14	11	72	M10 Depth 16	7	18	18	M18 X 1.5	69	1/4	102

Bore (mm)	TA	TC	H	ZZ
20	11	M5	35	147
25	11	M6 X 0.75	40	157
32	11	M8 X 1.0	40	159
40	12	M10 X 1.25	50	187
50	13	M12 X 1.25	58	218
63	13	M14 X 1.5	58	218

Note 1) Dimensions are the same as CG1W standard. Refer to p.1.7-19.  
 Note 2) Old number is made-to-order CG1\*N\*\*-\*XC21.

CJ1

CJP

CJ2

CM2

C85

C76

**CG1**

MB

MB1

CP95

C95

C92

CA1

CS1

## ⚠ Precautions

Be sure to read before handling. Refer to p.0-39 to 0-46 for Safety Instruction and common precautions.

### Handling

#### ⚠ Cautions

① Avoid using the air cylinder in such a way that rotational torque would be applied to the piston rod.

- If rotational torque is applied, the non-rotating guide will become deformed, thus affecting the non-rotating accuracy. Refer to the table below for the approximate values of the allowable range of rotational torque.

Allowable rotational torque (Nm)	ø20	ø25/ø32	ø40/ø50/ø63
	0.2	0.25	0.44

- To screw a bracket or a nut onto the piston rod, make sure to retract the piston rod entirely, and place a wrench over the flat portion of the rod that protrudes.

To tighten, take precautions to prevent the tightening torque from being applied to the non-rotating guide.

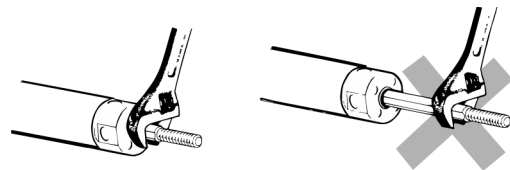

② To replace a rod seal, contact SMC.

A rod seal could lead to an air leak, depending on the position in which it is fitted. Therefore, make sure to contact SMC if a rod seal must be replaced.

# Series CDG1KW Auto Switch Specifications

Refer to p.5.3-2 for details of the auto switch.



## ⚠ Precautions

Be sure to read before handling.  
Refer to p.0-44 to 0-46 for Safety  
Instructions and common  
precautions.

## Applicable auto switch

Auto switch model		Electrical entry (Function)	Page
Reed switch	D-C7, C8	Grommet	5.3- 9
	D-C73C, C80C	Connector	5.3-11
	D-B5, B6	Grommet	5.3-10
	D-B59W	Grommet (2 colour indicator)	5.3-25
Solid state switch	D-H7□	Grommet	5.3-29
	D-H7□W	Grommet (2 colour indicator)	5.3-42
	D-H7LF	Grommet (2 colour, Latch with diagnostic output)	5.3-49
	D-H7NF	Grommet (2 colour, Diagnostic output)	5.3-50
	D-H7BAL	Grommet (2 colour, Water resistant)	5.3-55
	D-H7C	Connector	5.3-31
	D-G5, K5	Grommet	5.3-30
	D-G5□W, K59W	Grommet (2 colour indicator)	5.3-43
	D-G59F	Grommet (2 colour, Diagnostic output)	5.3-51
	D-G5NTL	Grommet (With timer)	5.3-59
	D-G5BAL	Grommet (2 colour, Water resistant)	5.3-56

## Auto Switch Mounting Position and Mounting Height

### D-B5/B6

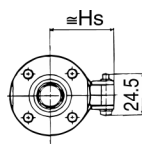
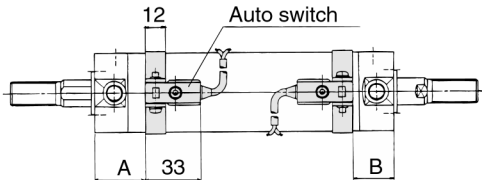

### D-C7/C8

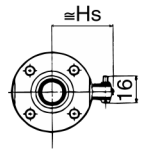
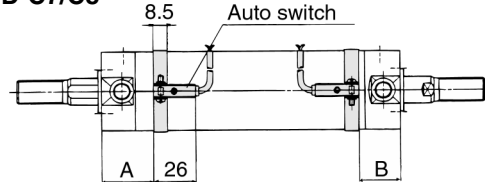

### D-G5/K5/G5DW/G5BAL D-K59W/G59F/G5NT

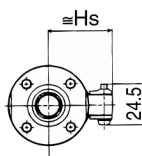
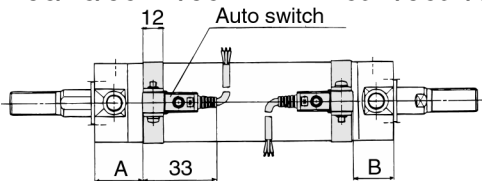

### D-H7C

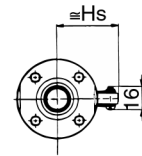
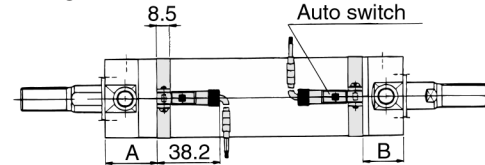

### D-H7□/H7□W/H7□F/H7BAL

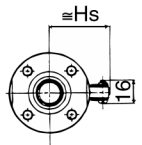
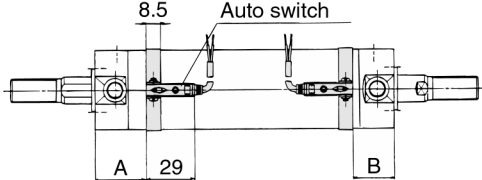

### D-C73C

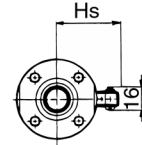
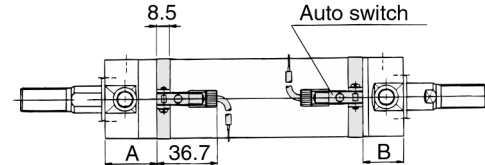

( ): D-H7LF (36)

## Auto Switch Mounting Height

(mm)

Bore (mm)	D-C7/D-C8			D-C73C/D-C80C			D-B5/D-B6			D-B59W		
	A	B	Hs	A	B	Hs	A	B	Hs	A	B	Hs
20	30	28.5	24.5	30	28.5	27	24	22.5	27	27	25.5	27.5
25	30	28.5	27	30	28.5	29.5	24	22.5	30	27	25.5	30
32	31	29.5	30.5	31	29.5	33	25	23.5	33.5	28	26.5	33.5
40	35.5	33	35	35.5	33	37.5	29.5	27	38	32.5	30	38
50	43	40.5	40.5	43	40.5	43	37	34.5	43.5	40	37.5	43.5
63	43	40.5	47.5	43	40.5	50	37	34.5	50.5	40	37.5	50.5
80	—	—	—	—	—	—	46.5	45	59	49.5	48	59
100	—	—	—	—	—	—	46.5	45	69.5	49.5	48	69.5

(mm)

Bore (mm)	D-H7□ D-H7□W			D-H7C D-H7BAL			D-H7□F			D-G5 D-G5N D-K59N			D-K5 D-G5□W			D-G59F		
	A	B	Hs	A	B	Hs	A	B	Hs	A	B	Hs	A	B	Hs	A	B	Hs
20	29	27.5	27	27.5	26	24.5	25.5	24	27.5	24	22.5	27.5	24	22.5	27.5	24	22.5	27.5
25	29	27.5	30	27.5	26	27	25.5	24	30	24	22.5	30	24	22.5	30	24	22.5	30
32	30	28.5	33	28.5	27	30.5	26.5	25	33.5	25	23.5	33.5	25	23.5	33.5	25	23.5	33.5
40	34.5	32	37.5	33	30.5	35	31	28.5	38	29.5	27	38	29.5	27	38	29.5	27	38
50	42	39.5	43	40.5	38	40.5	38.5	36	43.5	37	34.5	43.5	37	34.5	43.5	37	34.5	43.5
63	42	39.5	50	40.5	38	47.5	38.5	36	50.5	37	34.5	50.5	37	34.5	50.5	37	34.5	50.5
80	—	—	—	—	—	—	48	46.5	59	46.5	45	59	46.5	45	59	46.5	45	59
100	—	—	—	—	—	—	48	46.5	69.5	46.5	45	69.5	46.5	45	69.5	46.5	45	69.5

# Direct Mount: Double Acting

# Series *CG1R*

ø20, ø25, ø32, ø40, ø50, ø63

## How to Order

**Standard**

**With auto switch**

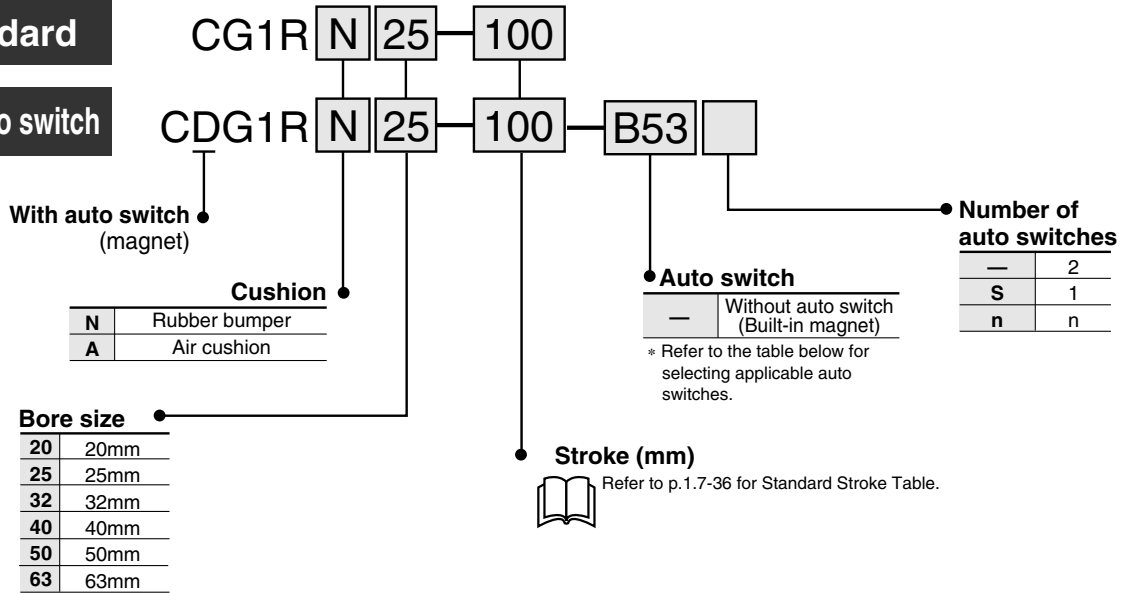

### Applicable Auto Switches/Refer to p.5.3-2 for further information on auto switch.

Style	Special function	Electrical entry	Indicator	Wiring (output)	Load voltage		Auto switch model		Lead wire (m)*				Applicable load			
					DC	AC			0.5 (-)	3 (L)	5 (Z)	None (N)				
Reed switch	—	Grommet	Yes	3 wire (NPN)	—	5V	—	C76	—	●	●	—	—	IC	—	
										●	●	●	—	—	PLC	
				2 wire	24V	12V	200V or less	—	B53	●	●	●	—	—	—	—
								—	B54	●	●	●	—	—	—	
		Connector	No	100V	100V or less	—	B64	●	●	—	—	—	—	—		
						—	C73	●	●	●	—	—	—			
		Connector	Yes	12V	—	5V, 12V	100V or less	—	C80	—	●	●	—	—	IC	Relay PLC
						—	—	—	C73C	—	●	●	●	●	—	
Connector	No	5V, 12V	24V or less	—	—	—	C80C	—	●	●	●	●	—	IC	—	
				—	—	—	—	B59W	●	●	—	—	—	—		
Solid state switch	—	Grommet	Yes	3 wire (NPN)	5V, 12V	—	—	H7A1	G59	●	●	○	—	IC	Relay PLC	
				3 wire (PNP)				H7A2	G5P	●	●	○	—	—		
		Connector	No	12V	—	—	—	H7B	K59	●	●	○	—	—		
								H7C	—	●	●	●	●	—		—
		Grommet	Yes	5V, 12V	—	—	—	H7NW	G59W	●	●	○	—	IC		
								H7PW	G5PW	●	●	○	—	—		
		Grommet	No	12V	—	—	—	H7BW	K59W	●	●	○	—	—		
								H7BA	G5BA	—	●	○	—	—		
		Grommet	Yes	5V, 12V	—	—	—	—	G5NT	—	●	○	—	IC		
								H7NF	G59F	●	●	○	—	—		
Grommet	No	12V	—	—	—	—	—	—	●	●	○	—	—			
						H7LF	—	●	●	○	—	—				

\* Lead wire length 0.5m.....— 3m.....L e.g.) C73C 5m.....Z None.....N e.g.) C73CZ C73CN

\* Solid state switches marked with "○" are manufactured upon receipt of order.

- CJ1
- CJP
- CJ2
- CM2
- C85
- C76
- CG1**
- MB
- MB1
- CP95
- C95
- C92
- CA1
- CS1

# Series CG1R

The CG1R Series direct mount cylinder can be installed directly through the use of a square rod cover.

## Space saving configuration

Because it is directly mounted without using brackets, its overall length is shorter, and its installation pitch can be made smaller. Thus, the space that is required for installation has been dramatically reduced.



## JIS symbol

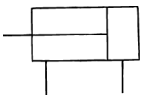

Made to order

Refer to P.5.4-1 for made to order products of series CG1R.

## Precautions

Be sure to read before handling.  
Refer to p.0-39 to 0-43 for Safety Instruction and common precautions.  
Refer to p.1.7-6 for precautions on series CG1K.

## Specifications

Bore size (mm)	20	25	32	40	50	63
Action	Double acting/Single rod					
Lubrication	Non-lube					
Fluid	Air					
Proof pressure	1.5MPa					
Max. operating pressure	1.0MPa					
Min. operating pressure	0.05MPa					
Ambient and fluid temperature	Without auto switch: -10 to +70°C (No freezing)					
	With auto switch: -10 to +60°C (No freezing)					
Piston speed	50 to 1000mm/s					
Thread tolerance	JIS class 2					
Stroke tolerance	up to 300 <sup>+1.4</sup> <sub>0</sub> mm					
Cushion	Rubber bumper/Air cushion					

## Weight

Bore size (mm)	20	25	32	40	50	63
Basic weight	0.14	0.23	0.35	0.57	1.04	1.49
Single knuckle joint	0.05	0.09	0.09	0.10	0.22	0.22
Double knuckle joint (with pins)	0.05	0.09	0.09	0.13	0.26	0.26
Additional weight by each 50 stroke	0.05	0.07	0.09	0.15	0.22	0.26
Additional weight by air cushion	0.01	0.01	0.02	0.02	0.03	0.03

Calculation example: CG1RN32-100 • Basic weight.....0.35  
(ø32, 100 stroke) • Additional weight.....0.09/50 stroke  
• Cylinder stroke.....100 stroke  
0.35+0.09 X 100/50=0.53kg

## Accessories

	Mounting	Basic
Standard	Rod end nut	●
	Single knuckle joint	●
Option	Double knuckle joint* (with pins)	●

\* Pins and snap rings for double knuckle joint are included, not mounted.

## Stroke

Bore size (mm)	Standard stroke* (mm)
20	25, 50, 75, 100, 125, 150
25/32	25, 50, 75, 100, 125, 150, 200
40/50/63	25, 50, 75, 100, 125, 150, 200, 250, 300

\* Other intermediate strokes can be manufactured upon receipt of order. Long strokes are not available. Spacers are not used for the intermediate strokes.

## Auto Switch Mounting Bracket Part No.

Auto switch model	Bore size (mm)					
	20	25	32	40	50	63
D-C7/C8	BMA2-020	BMA2-025	BMA2-032	BMA2-040	BMA2-050	BMA2-063
D-H7						
D-B5/B6	BA-01	BA-02	BA-32	BA-04	BA-05	BA-06
D-G5/K5						



Note) A set of following stainless steel mounting screws is attached. (A switch mounting band is not attached. Please order the band separately.)

BBA3: D-B5/B6/G5 types

BBA4: D-C7/C8/H7 types

\* "D-G5BAL" and "D-H7BAL" switches are set on the cylinder with the screws above when shipped.

When a switch only is shipped, "BBA3" or "BBA4" screws are attached.

# Direct Mount: Double Acting *Series CG1R*

## Clean Series

10-CG1RN **Bore size** — **Stroke**

- Clean series (with relief port)

The rod portion of the actuator has a double seal construction, and a relief port is provided to discharge the exhaust air directly outside of the clean room. Thus, it can be used in a Class 100 clean room.

## Specifications

Bore size (mm)	ø20, ø25, ø32, ø40, ø50, ø63
Action	Double acting
Fluid	Air
Max. operating pressure	1.0MPa
Min. operating pressure	0.05MPa
Cushion	Rubber bumper
Piston speed	50 to 400mm/s
Relief port size	M5

\* Auto switch can be mounted.

## Copper Free

20-CG1R **Cushion** — **Bore size** — **Stroke**

- Copper free

This cylinder eliminates any influences of copper ions or fluororesins on colour CRTs. Copper materials have been nickel plated or replaced with non-copper materials to prevent the generation of copper ions.

## Specifications

Bore size (mm)	ø20, ø25, ø32, ø40, ø50, ø63	
Action	Double acting	
Fluid	Air	
Max. operating pressure	1.0MPa	
Min. operating pressure	0.05MPa	
Cushion	Symbol N	Rubber bumper
	Symbol A	Air cushion
Piston speed	50 to 1000mm/s	

\* Auto switch can be mounted.

## Construction

### Standard/Bottom mounting/With rubber bumper

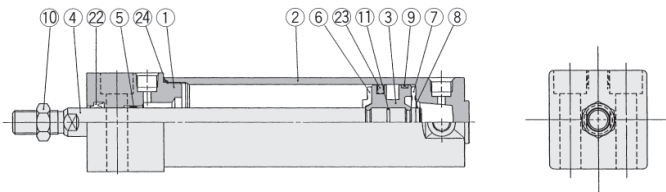

### With air cushion

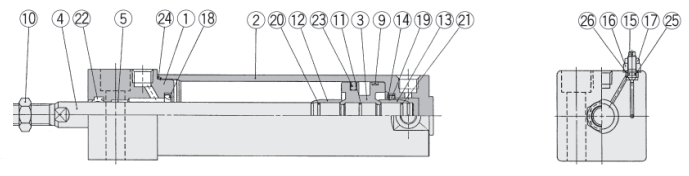

## Component Parts

No.	Description	Material	Note
①	Rod cover	Aluminum alloy	White hard anodized
②	Tube cover	Aluminum alloy	White hard anodized
③	Piston	Aluminum alloy	Chromated
④	Piston rod*	Carbon steel	Hard chrome plated
⑤	Bushing	Oil impregnated sintered alloy	ø40 or larger: Lead bronze cast
⑥	Bumper A	Urethane	
⑦	Bumper B	Urethane	ø40 or larger: the same as bumper A
⑧	Snap ring	Stainless steel	
⑨	Wear ring	Resin	
⑩	Rod end nut	Rolled steel	Nickel plated
⑪	Piston gasket	NBR	

No.	Description	Material	Note
⑫	Cushion ring A	Brass	
⑬	Cushion ring B	Brass	ø32 or larger: the same as ring A
⑭	Seal retainer	Rolled steel	
⑮	Cushion valve	Rolled steel	Electroless nickel plated
⑯	Valve retainer	Rolled steel	Electroless nickel plated
⑰	Lock nut	Carbon steel	Nickel plated
⑱	Cushion seal A	Urethane	
⑲	Cushion seal B	Urethane	
⑳	Cushion ring gasket A	NBR	
㉑	Cushion ring gasket B	NBR	ø32 or larger: the same as gasket A

Note) A rubber magnet is equipped on the piston of the cylinder with auto switch.

\* The material is stainless steel on auto switch equipped styles ø20 and ø25.

## Replacement Parts/With rubber bumper

No.	Description	Material	Bore size (mm)/Part No.					
			ø20	ø25	ø32	ø40	ø50	ø63
㉒	Rod seal	NBR	PDU-8Z	PDU-10Z	PDU-12LZ	PDU-16Z	PDU-20Z	PDU-20Z
㉓	Piston seal	NBR	PPD-20	PPD-25-19	PPD-32	PPD-40	PPD-50	PPD-63
㉔	Tube gasket	NBR	CM-020-16-123	CM-025-16-124	CM-032-16-126	CM-040-16-127	CM-050-16-128	CM-063-16-129

## With air cushion (Parts ㉒ to ㉔ are the same as rubber bumper style.)

㉕	Valve seal	NBR	O ring ø4.5 X ø2.5 X ø1				O ring ø5.5 X ø3.5 X ø1	
㉖	Valve retaining gasket	NBR	O ring ø6.4 X ø5.2 X ø0.6				O ring ø7.4 X ø5.8 X ø0.8	

CJ1

CJP

CJ2

CM2

C85

C76

CG1

MB

MB1

CP95

C95

C92

CA1

CS1

# Series CG1R

## Basic: Bottom Mounting

### With rubber bumper/CG1RN

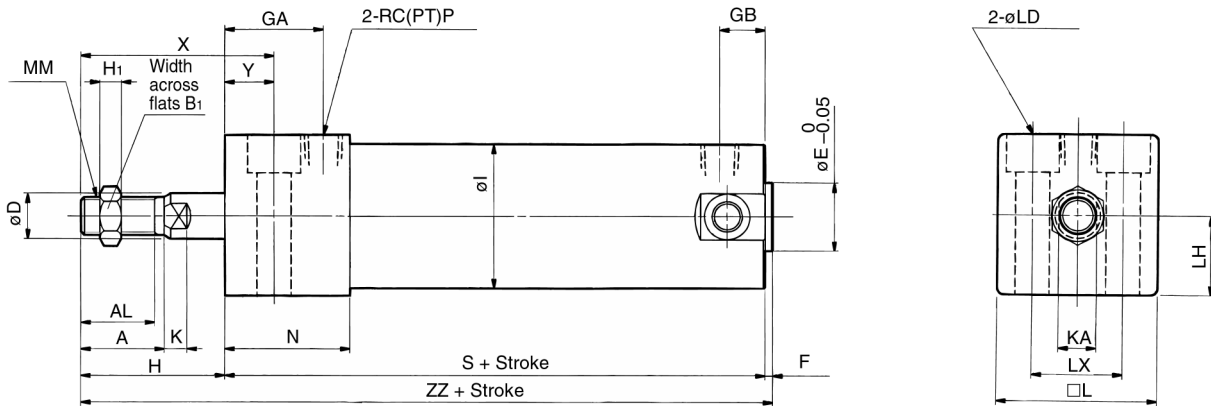

### With air cushion/CG1RA

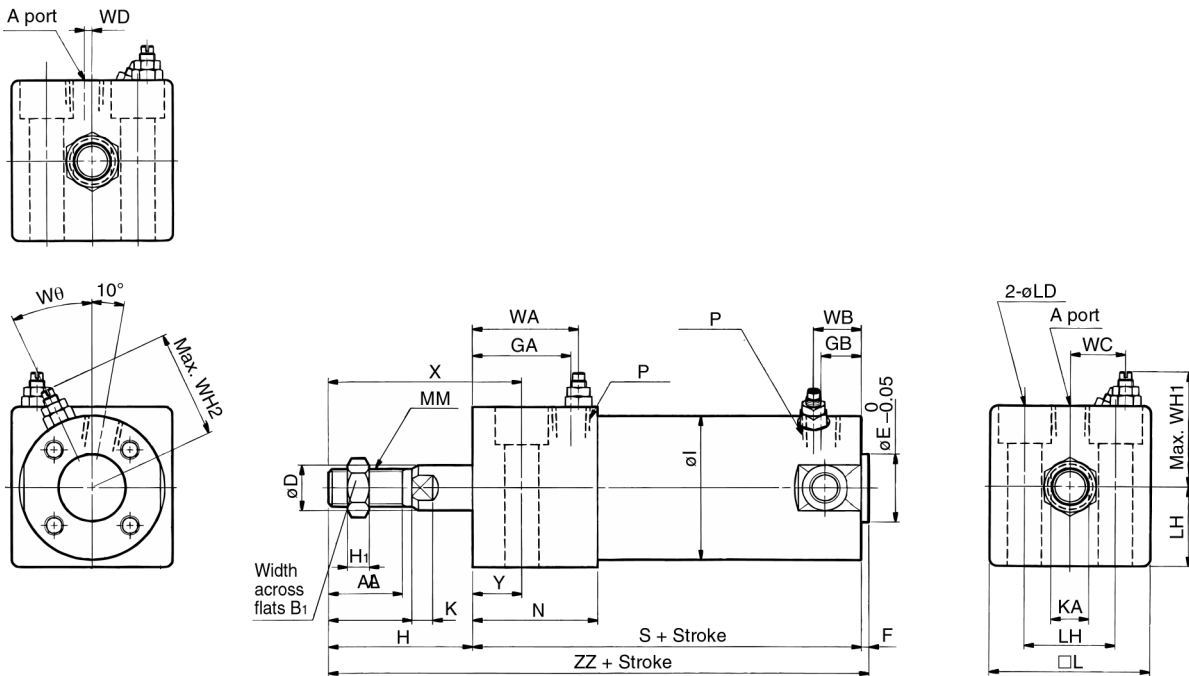

Bore (mm)	Stroke range (mm)	A	AL	B <sub>1</sub>	D	E	GA	GB	H	H <sub>1</sub>	I	K	KA	□L	LD	LH	LX	MM	N	P	S	X	Y	ZZ
20	Up to 150	18	15.5	13	8	12	20	10	27	5	26	5	6	30.4	ø5.5, ø9.5 Depth of counter bore 6	15	18	M8	27	1/8	75	38	11	104
25	Up to 200	22	19.5	17	10	14	22	10	32	6	31	5.5	8	36.4	ø6.6, ø11 Depth of counter bore 7	18	22	M10 X 1.25	29	1/8	77	44	12	111
32	Up to 200	22	19.5	17	12	18	26	10	32	6	38	5.5	10	42.4	ø9, ø14 Depth of counter bore 9	21	24	M10 X 1.25	33	1/8	83	45	13	117
40	Up to 300	30	27	19	16	25	30	10	39	8	47	6	14	52.4	ø11, ø17.5 Depth of counter bore 12	26	32	M14 X 1.5	37	1/8	94	55	16	135
50	Up to 300	35	32	27	20	30	33	12	45	11	58	7	18	64.5	ø14, ø20 Depth of counter bore 14	32	41	M18 X 1.5	44	1/4	108	62	17	155
63	Up to 300	35	32	27	20	32	39	12	45	11	72	7	18	76.6	ø18, ø26 Depth of counter bore 18	38	46	M18 X 1.5	50	1/4	114	64	19	161

### With air cushion (mm)

Bore (mm)	Stroke range (mm)	P	WA	WB	WC	WD	WH	WH <sub>2</sub>	Wθ
20	Up to 150	M5	20	15	8.5	2	25	23	30°
25	Up to 200	M5	24	15	11	2	27.5	25	30°
32	Up to 200	Rc(PT)1/8	28	15	14.5	—	30.5	28.5	25°
40	Up to 300	Rc(PT)1/8	32	15	18.5	—	35.5	33	20°
50	Up to 300	Rc(PT)1/4	35	17	22	—	43.5	40.5	20°
63	Up to 300	Rc(PT)1/4	41	17	29	—	49.5	47.5	20°

## Auto Switch Mounting Position and Mounting Height

D-C7

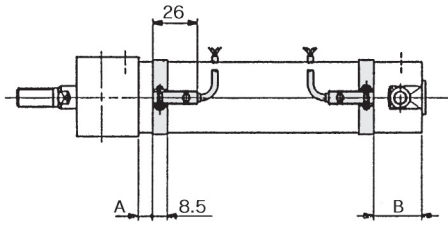

D-G5, D-K5

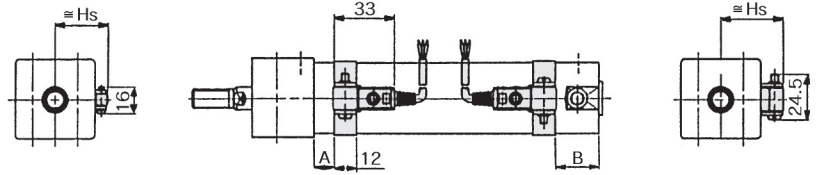

D-H

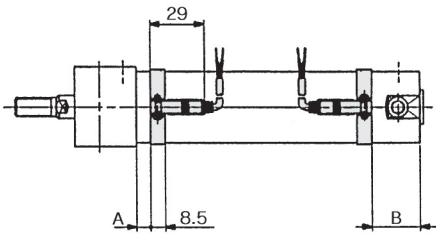

D-C73C

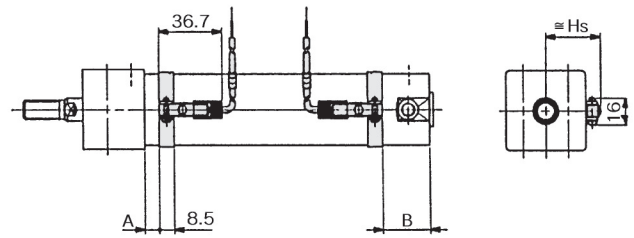

D-B

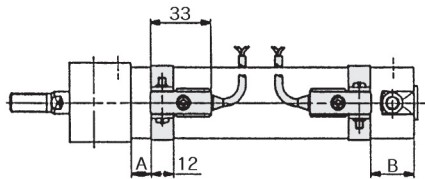

D-H7C

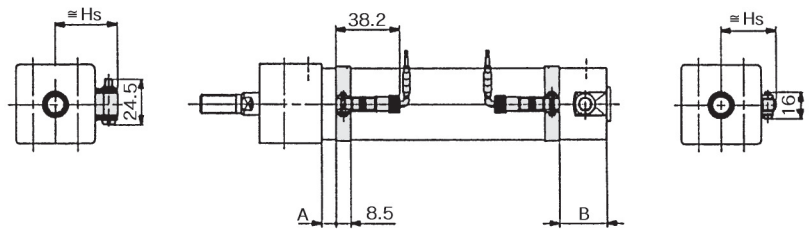

CJ1

CJP

CJ2

CM2

C85

C76

**CG1**

MB

MB1

CP95

C95

C92

CA1

CS1

### Auto Switch Mounting Position

### Mounting Height

Auto switch model	D-C7, C8 D-C73C, C80C		D-B5, B6 D-G5□W, K59W D-G59F D-G5BAL		D-B59W		D-H7□ D-H7C		D-H7□W D-H7□F D-H7BAL		D-G5 D-K5 D-G5NTL	
	A	B	A	B	A	B	A	B	A	B	A	B
Bore size 20	9	20.5	3	14.5	6	17.5	8	19.5	6.5	18	4.5	16
25	9	20.5	3	14.5	6	17.5	8	19.5	6.5	18	4.5	16
32	10	21.5	4	15.5	7	18.5	9	20.5	7.5	19	5.5	17
40	14.5	24	8.5	18	11.5	21	13.5	23	12	21.5	10	19.5
50	17	28.5	11	22.5	14	25.5	16	27.5	14.5	26	12.5	24
63	17	28.5	11	22.5	14	25.5	16	27.5	14.5	26	12.5	24

D-C7, C8 D-H7□ D-H7□W D-H7□F D-H7BAL		D-C73C D-C80C	D-B5, B6 D-B59W D-G5, K5 D-G5□W D-K59W	D-G5NTL D-G59F D-G5BAL
Hs		Hs	Hs	
24.5		27	27.5	
27		29.5	30	
30.5		33	33.5	
35		37.5	38	
40.5		43	43.5	
47.5		50	50.5	

# Direct Mount Non-rotating Rod: Double Acting

# Series CG1KR

ø20, ø25, ø32, ø40, ø50, ø63

## How to Order

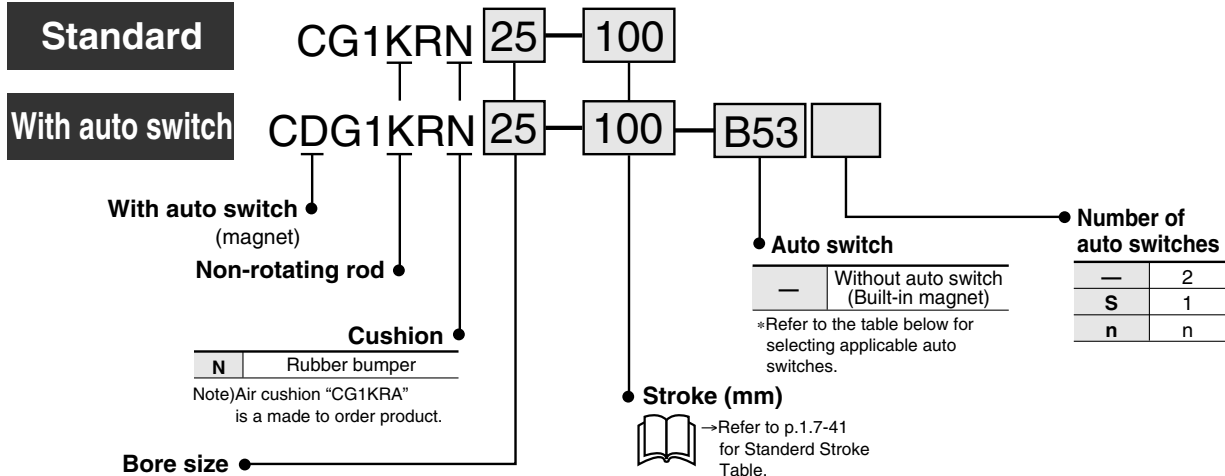

**Bore size**

20	20mm
25	25mm
32	32mm
40	40mm
50	50mm
63	63mm

### Applicable Auto Switches/Refer to p.5.3-2 for further information on auto switch.

Style	Special function	Electrical entry	Indicator	Wiring (output)	Load voltage		Auto switch model		Lead wire (m)*				Applicable load		
					DC	AC	0.5 (-)	3 (L)	5 (Z)	None (N)					
Reed switch	—	Grommet	Yes	3 wire (NPN)	—	5V	—	C76	—	●	●	—	—	IC	
								2 wire	24V	100V or less	B53	—	●	●	●
				B54	—	●	●				—	—	—	—	
				B64	—	●	●				—	—	—	—	
				C73	—	●	●				●	—	—	—	
				C80	—	●	●				—	—	—	IC	
				Connector	Yes	C73C	—	●	●	●	●	—	—		
No	C80C	—	●		●	●	●	—	IC						
Diagnostic indication (2 colour)	Grommet	Yes	—	—	—	—	B59W	—	●	●	—	—	—		
Solid state switch	—	Grommet	Yes	3 wire (NPN)	5V, 12V	—	—	H7A1	G59	●	●	○	—	IC	
				3 wire (PNP)				H7A2	G5P	●	●	○	—	—	
		Connector	No	2 wire	12V	—	—	—	H7B	K59	●	●	○	—	—
				2 wire	—	—	—	H7C	—	●	●	●	●	—	—
	Diagnostic indication (2 colour)	Grommet	Yes	3 wire (NPN)	5V, 12V	—	—	H7NW	G59W	●	●	○	—	IC	
				3 wire (PNP)				H7PW	G5PW	●	●	○	—	—	
				2 wire	12V	—	—	H7BW	K59W	●	●	○	—	—	
				2 wire				H7BA	G5BA	—	●	○	—	—	
				3 wire (NPN)	5V, 12V	—	—	—	G5NT	—	●	○	—	IC	
				4 wire (NPN)				H7NF	G59F	●	●	○	—	—	
				Water resistant (2 colour)	—	—	—	—	—	—	H7LF	—	●	●	○
With timer															
Diagnostic output (2 colour)															
Latch with diagnostic output (2 colour)															

\* Lead wire length 0.5m.....— e.g.) C73C, 5m.....Z e.g.) C73CZ, 3m.....L C73CL None.....N C73CN

\* Solid state switches marked with "○" are manufactured upon receipt of order.

### Auto Switch Mounting Bracket Part No.

Auto switch model	Bore size (mm)					
	20	25	32	40	50	63
D-C7/C8	BMA2-020	BMA2-025	BMA2-032	BMA2-040	BMA2-050	BMA2-063
D-H7						
D-B5/B6	BA-01	BA-02	BA-32	BA-04	BA-05	BA-06
D-G5/K5						



Note) A set of following stainless steel mounting screws is attached. (A switch mounting band is not attached. Please order the band separately.)  
 BBA3: D-B5/B6/G5 types  
 BBA4: D-C7/C8/H7 types  
 \* "D-G5BAL" and "D-H7BAL" switches are set on the cylinder with the screws above when shipped.  
 When a switch only is shipped, "BBA3" or "BBA4" screws are attached.



# Direct Mount Non-rotating Rod: Double Acting *Series CG1KR*

The CG1R Series direct mount cylinder can be installed directly through the use of a square rod cover.

## Space saving configuration

Because it is directly mounted without using brackets, its overall length is shorter, and its installation pitch can be made smaller. Thus, the space that is required for installation has been dramatically reduced.



## JIS symbol

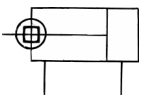

## Specifications

Bore size (mm)	20	25	32	40	50	63
Action	Double acting/Single rod					
Lubrication	Non-lube					
Fluid	Air					
Proof pressure	1.5MPa					
Max. operating pressure	1.0MPa					
Min. operating pressure	0.05MPa					
Ambient and fluid temperature	Without auto switch: -10°C to +70°C (No freezing)					
	With auto switch: -10°C to +60°C (No freezing)					
Piston speed	50 to 500mm/s					
Stroke tolerance	JIS class 2					
Thread tolerance	up to 300 <sup>+1.4</sup> <sub>0</sub> mm					
Cushion	Rubber bumper					
Rod non-rotating accuracy	±1°	±0.8°	±0.8°	±0.5°	±0.5°	±0.5°

## Weight

Bore size (mm)	20	25	32	40	50	63
Basic weight	0.14	0.24	0.35	0.56	1.04	1.48
Single knuckle joint	0.05	0.09	0.09	0.10	0.22	0.22
Double knuckle joint (with pins)	0.05	0.09	0.09	0.13	0.26	0.26
Additional weight by each 50 stroke	0.05	0.07	0.09	0.15	0.22	0.26

Calculation example: CG1KRN32-100 (ø32, 100 stroke)

- Basic weight.....0.35
- Additional weight.....0.09/50 stroke
- Cylinder stroke.....100 stroke

0.35+0.09 X 100/50=0.53kg

## Stroke

Bore size (mm)	Standard stroke* (mm)
20	25, 50, 75, 100, 125, 150
25/32	25, 50, 75, 100, 125, 150, 200
40/50/63	25, 50, 75, 100, 125, 150, 200, 250, 300

\* Other intermediate strokes can be manufactured upon receipt of order. Long strokes are not available. Spacers are not used for the intermediate strokes.

## Accessories

	Mounting	Basic type
Standard	Rod end nut	●
	Single knuckle joint	●
Option	Double knuckle joint* (with pins)	●

\* Pins and snap rings for double knuckle joint are attached, not mounted.

## ⚠ Precautions

**Be sure to read before handling.**  
**Refer to p.0-39 to 0-46 for Safety Instruction and common precautions.**  
**Refer to p.1.7-6 for precautions on CG1K series.**

## Handling

### ⚠ Cautions

- ① **Avoid using the air cylinder in such a way that rotational torque would be applied to the piston rod.**
  - If rotational torque is applied, the non-rotating guide will become deformed, thus affecting the non-rotating accuracy. Refer to the table below for the allowable range of rotational torque.

Allowable rotational torque Nm	ø20	ø25/ø32	ø40/ø50/ø63
	0.2	0.25	0.44

- To screw a bracket or a nut onto the piston rod, make sure to retract the piston rod entirely, and place a wrench over the flat portion of the rod that protrudes. To tighten, take precautions to prevent the tightening torque from being applied to the non-rotating guide.

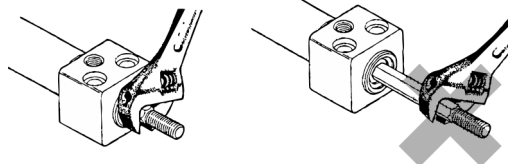

- ② **To replace a rod seal, contact SMC.**

A rod seal could lead to an air leak, depending on the position in which it is fitted. Therefore, make sure to contact SMC if a rod seal must be replaced.

CJ1

CJP

CJ2

CM2

C85

C76

CG1

MB

MB1

CP95

C95

C92

CA1

CS1

# Series CG1KR

## Construction

### Non-rotating rod/Bottom mounting

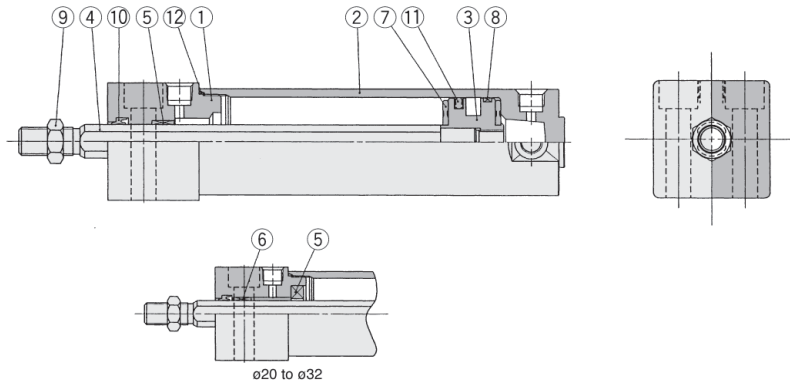

### Component Parts

No.	Description	Material	Note
①	Rod cover	Aluminum alloy	White hard anodized
②	Tube gasket	Aluminum alloy	White hard anodized
③	Piston	Aluminum alloy	Chromated
④	Piston rod*	Carbon steel	Hard chrome plated
⑤	Non-rotating guide	Oil impregnated sintered alloy	
⑥	Bushing	Oil impregnated sintered alloy	ø20 to ø32 only
⑦	Rod end nut	Rolled steel	Nickel plated
⑧	Bumper	Urethane	
⑨	Wear ring	Resin	

\* The material is stainless steel for ø20, ø25, and ø32

### Replacement Parts

No.	Description	Material	Bore size (mm)/Part No.					
			ø20	ø25	ø32	ø40	ø50	ø63
⑩	Rod seal	NBR	SS-9 X 8K2Q	SS-11 X 10K2	SS-12	SS-16S	SS-20S	
⑪	Piston seal	NBR	PPD-20	PPD-25-19	PPD-32	PPD-40	PPD-50	PPD-63
⑫	Tube gasket	NBR	CM-020-16-123	CM-025-16-124	CM-032-16-126	CM-040-16-127	CM-050-16-128	CM-063-16-129

### Basic/Bottom mounting: CG1KRN

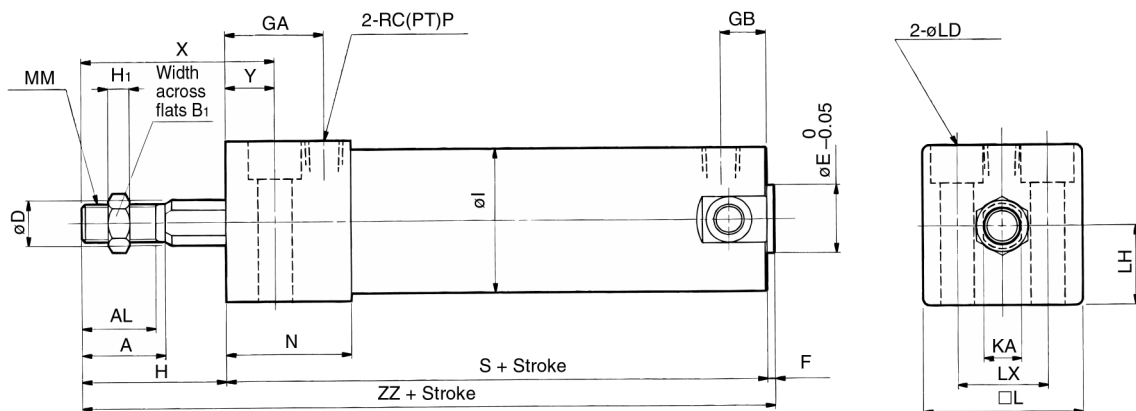

Bore (mm)	Stroke range (mm)	A	AL	B <sub>1</sub>	D	E	GA	GB	H	H <sub>1</sub>	I	KA	L	LD	LH	LX	MM	N	P	S	X	Y	ZZ
20	Up to 150	18	15.5	13	9.2	12	20	10	27	5	26	8	30.4	ø5.5, ø9.5 Depth of counter bore <sup>6</sup>	15	18	M8	27	1/8	75	38	11	104
25	Up to 200	22	19.5	17	11	14	22	10	32	6	31	10	36.4	ø6.6, ø11 Depth of counter bore <sup>7</sup>	18	22	M10 X 1.25	29	1/8	77	44	12	111
32	Up to 200	22	19.5	17	12	18	26	10	32	6	38	10	42.4	ø9, ø14 Depth of counter bore <sup>9</sup>	21	24	M10 X 1.25	33	1/8	83	45	13	117
40	Up to 300	30	27	19	16	25	30	10	39	8	47	14	52.4	ø11, ø17.5 Depth of counter bore <sup>12</sup>	26	32	M14 X 1.5	37	1/8	94	55	16	135
50	Up to 300	35	32	27	20	30	33	12	45	11	58	18	64.5	ø14, ø20 Depth of counter bore <sup>14</sup>	32	41	M18 X 1.5	44	1/4	108	62	17	155
63	Up to 300	35	32	27	20	32	39	12	45	11	72	18	76.6	ø18, ø26 Depth of counter bore <sup>18</sup>	38	46	M18 X 1.5	50	1/4	114	64	19	161

Auto switch mounting position is the same as that on p.1.7-39.

# Low Friction: Double Acting Single rod

# Series CG1□Q

ø20, ø25, ø32, ø40, ø50, ø63, ø80, ø100

## How to Order

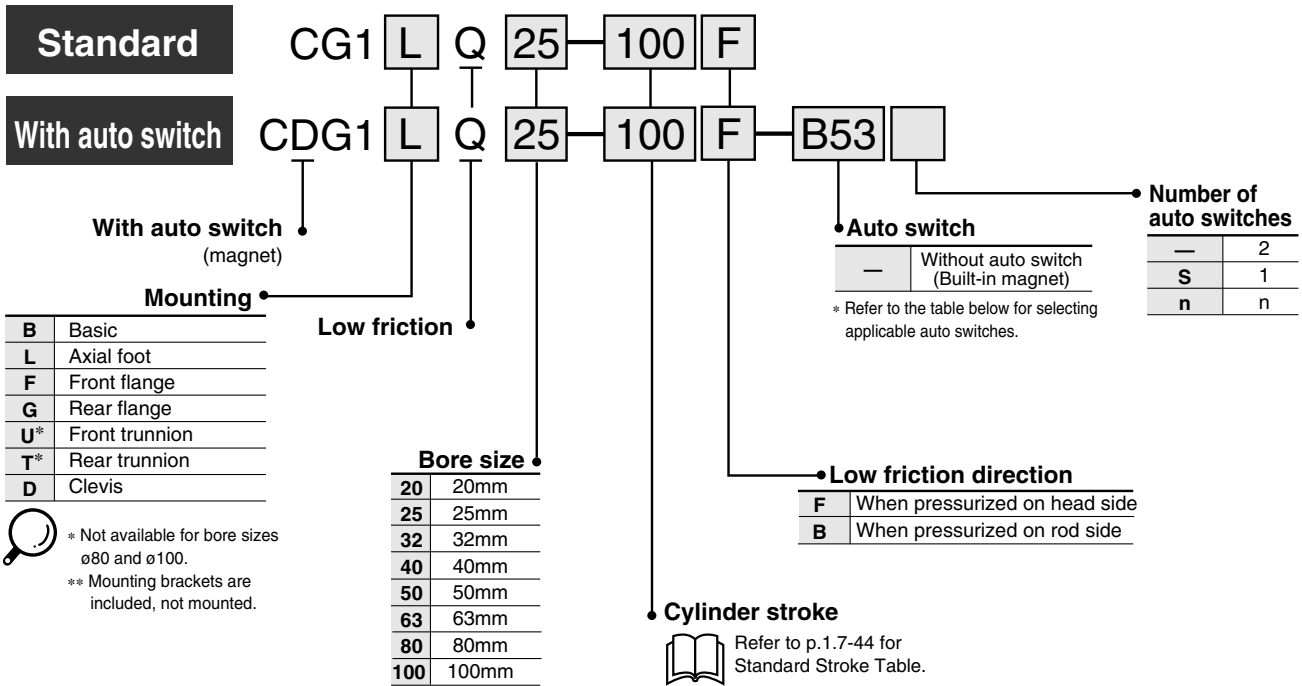

\* Not available for bore sizes ø80 and ø100.  
\*\* Mounting brackets are included, not mounted.

- CG1
- CJ1
- CJP
- CJ2
- CM2
- C85
- C76
- MB
- MB1
- CP95
- C95
- C92
- CA1
- CS1

### Applicable Auto Switches/Refer to p.5.3-2 for further information on auto switch.

Style	Special function	Electrical entry	Indicator	Wiring (Output)	Load voltage		Auto switch model		Lead wire (m)*				Applicable load																					
					DC	AC	Applicable bore size		0.5 (-)	3 (L)	5 (Z)	None (N)																						
							ø20 to ø63	ø20 to ø100																										
Reed switch	—	Grommet	Yes	3 wire (NPN)	—	5V	—	C76	—	●	●	—	—	IC																				
								2 wire	24V	200V or less	B53	—	●	●	●	—	—	PLC																
											B54	—	●	●	—	—	—	—																
											B64	—	●	●	—	—	—	—																
											C73	—	●	●	●	—	—	—																
											C73C	—	●	●	●	●	—	—	—	—														
																					C80	—	●	●	—	—	—	IC						
Solid state switch	Diagnostic indication (2 colour)	Grommet	Yes	2 wire	24V	5V, 12V	100V or less	C80C	—	●	●	●	●	—	IC																			
								B59W	—	●	●	—	—	—	—																			
								H7A1	G59	●	●	○	—	—	—	—	—	—																
																			H7A2	G5P	●	●	○	—	—	IC								
																			H7B	K59	●	●	○	—	—	—								
								H7C	—	●	●	●	●	—	—	—	—	—																
																			H7NW	G59W	●	●	○	—	—	—								
																											H7PW	G5PW	●	●	○	—	—	IC
																											H7BW	K59W	●	●	○	—	—	—
								H7BA	G5BA	—	●	○	—	—	—	—	—																	
—	G5NT	—	●	○	—	—	—																											
								H7NF	G59F	●	●	○	—	—	—	—	—																	
H7LF	—	●	●	○	—	—	—											—																

\* Lead wire length 0.5m.....L e.g.) C73C 5m.....Z e.g.) C73CZ  
3m.....L C73CL None.....N C73CN

\* Solid state switches marked with "○" are manufactured upon receipt of order.

# Series CG1□Q

Designed with a low sliding resistance of the piston, this air cylinder is ideal for applications such as contact pressure control, which requires smooth movements at low pressures.

## Low sliding resistance

## Stable sliding resistance

The sliding resistance remains stable even when the operating pressure changes.

Long strokes can be manufactured.

Auto switches can be mounted.



## JIS symbol

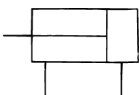

## ⚠ Precautions

Be sure to read before handling.  
Refer to p.0-39 to 0-43 for Safety Instruction and common precautions.  
Refer to p.1.7-6 for precautions on series CG1.

## Handling

### ⚠ Warning

- ① In the direction of low friction operation, speed control must be effected through the meter-in system.  
With meter-out control, the exhaust pressure will increase and create a greater sliding resistance.

## With auto switch

Auto switches can be mounted. Mounting position/height is the same as the double acting/single rod style. Refer to p.1.7-12 and 1.7-13.

## Mounting Bracket Part No.

Refer to p.1.7-45 for other mounting brackets.

## Auto Switch Mounting Bracket Part No.

Refer to p.1.7-45 for part number of the switch mounting band for adding auto switches on built-in magnet cylinders.

1-7-44

## Application Example

A low friction cylinder is used in combination with a precision regulator (IR Series, etc.).

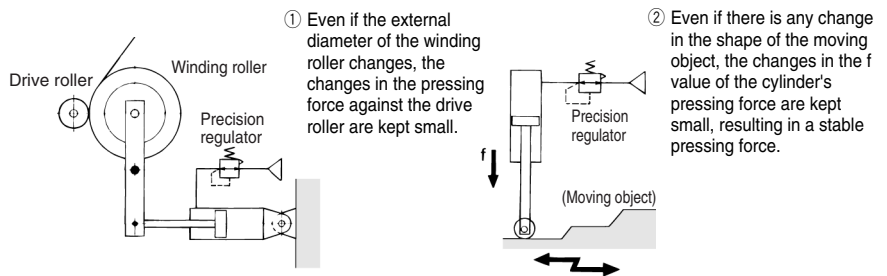

## Specifications

Bore size (mm)	20	25	32	40	50	63	80	100
Action	Double acting/Single rod							
Lubrication	Non-lube							
Fluid	Air							
Proof pressure	1.05MPa							
Max. operating pressure	0.7MPa							
Min. operating pressure	0.025MPa				0.01MPa			
Ambient and fluid temperature	Without auto switch: -10°C to +70°C (No freezing)							
	With auto switch: -10°C to +60°C (No freezing)							
Piston speed	500mm/s							
Stroke tolerance	up to 700 <sup>+1.4</sup> <sub>0</sub> mm							
Cushion	None				Rubber bumper			
Mounting	Basic, Axial foot, Front flange, Rear flange, Front trunnion, Rear trunnion, Clevis (Used for changing the port location by 90 degrees.)							
Low friction direction	One direction (Refer to "Selection of the direction".)							
Allowable leakage	0.5 ℓ /min (ANR) or less							



\* Long stroke applies to the axial foot type and the front flange type.  
Front/Rear trunnion types are not available for bore sizes ø80 and ø100.

## Accessories

Mounting	Basic	Axial foot	Front flange	Rear flange	Front trunnion	Rear trunnion	Clevis
Standard							
Rod end nut	●	●	●	●	●	●	●
Clevis pin	—	—	—	—	—	—	●
Option							
Single knuckle joint	●	●	●	●	●	●	●
Double knuckle joint** (with pins)	●	●	●	●	●	●	●
Pivot bracket	—	—	—	—	●*	●*	●

\* There are no pivot brackets for bore size ø80 and ø100.

\*\* Pins and snap rings for double knuckle joint are included, not mounted.

## Stroke Table

Bore size (mm)	Standard stroke (mm) <sup>(1)</sup>	Long stroke <sup>(2)</sup> (mm)
20	25, 50, 75, 100, 125, 150, 200	201 to 350
25		301 to 400
32		301 to 450
40	25, 50, 75, 100, 125, 150, 200	301 to 500
50/63	250, 300	301 to 600
80		301 to 700
100		301 to 700



- Note 1) Other intermediate strokes can be manufactured upon receipt of order. Refer to p.1.7-46 for dimensions.  
Note 2) The longer the stroke, the greater the sliding resistance could become, due to the sagging of the piston rod. Therefore, consider installing a guide for such operation.  
Note 3) Contact SMC for applications that exceed the stroke range shown above. (The maximum manufacturable stroke is 1500mm.)

# Low Friction: Double Acting Single Rod *Series CG1□Q*

## Sliding Resistance of the Low Friction Side

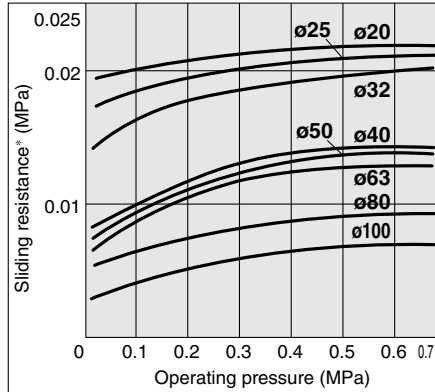

\* Conversion into the cylinder operating pressure:

## Selecting the Low Friction Direction

- To use the air cylinder as a balancer, pressurize it only from one of the ports as shown in the application example, and keep the other port open to the atmosphere.

**To operate by applying pressure from the rod cover port: Low friction direction B type** <Application example ①>

**To operate by applying pressure from the head cover port: Low friction direction F type** <Application example ②>

In either case, if the piston rod is moved by an external force, it will effect low friction operation both in the extending and retracting directions.

- When it is necessary to operate it as an ordinary double acting cylinder at an even lower operating speeds, use a low speed cylinder (see "Made to Order" on Page SPECIALS-1).

## Weight

Bore size (mm)		20	25	32	40	50	63	80	100
Basic weight	Basic	0.11	0.18	0.28	0.44	0.83	1.17	2.23	3.43
	Axial foot	0.22	0.31	0.44	0.66	1.31	1.89	3.19	5.18
	Flange	0.19	0.28	0.42	0.64	1.17	1.67	2.94	4.78
	Trunnion	0.12	0.20	0.31	0.49	0.97	1.31	—	—
	Clevis	0.16	0.26	0.43	0.67	1.23	1.85	2.94	4.71
Pivot bracket	0.08	0.09	0.17	0.25	0.44	0.80	0.98	1.75	—
Single knuckle joint	0.05	0.09	0.09	0.10	0.22	0.22	0.39	0.57	—
Double knuckle joint (with pins)	0.05	0.09	0.09	0.13	0.26	0.26	0.64	1.31	—
Additional weight by each 50 stroke	0.05	0.07	0.09	0.15	0.22	0.26	0.35	0.49	—

Calculation example: CG1LQ20-100B  
(Foot, ø20, 100 stroke)

- Basic weight.....0.22 (Foot, ø20)
- Additional weight.....0.05/50 stroke
- Cylinder stroke.....100 stroke
- 0.22+0.05 X 100/50=0.32kg

## Mounting Bracket Part No.

Mounting bracket	Bore size (mm)							
	20	25	32	40	50	63	80	100
Axial foot*	CG-L020	CG-L025	CG-L032	CG-L040	CG-L050	CG-L063	CG-L080	CG-L100
Flange	CG-F020	CG-F025	CG-F032	CG-F040	CG-F050	CG-F063	CG-F080	CG-F100
Trunnion	CG-T020	CG-T025	CG-T032	CG-T040	CG-T050	CG-T063	—	—
Clevis**	CG-D020	CG-D025	CG-D032	CG-D040	CG-D050	CG-D063	CG-D080	CG-D100
Pivot bracket	CG-020-24A	CG-025-24A	CG-032-24A	CG-040-24A	CG-050-24A	CG-063-24A	CG-080-24A	CG-100-24A



\* Order two foot brackets per cylinder.

\*\* Clevis pins, snap rings and mounting bolts are attached for the clevis style.

\*\*\* Mounting bolts are attached for the foot style and the flange style.

## Auto Switch Mounting Bracket Part No.

Auto switch model	Bore size (mm)							
	20	25	32	40	50	63	80	100
D-C7/C8	BMA2-020	BMA2-025	BMA2-032	BMA2-040	BMA2-050	BMA2-063	—	—
D-H7	—	—	—	—	—	—	—	—
D-B5/B6	BA-01	BA-02	BA-32	BA-04	BA-05	BA-06	BA-08	BA-10
D-G5/K5	—	—	—	—	—	—	—	—



Note 1) A set of following stainless steel mounting screws is attached.  
(A switch mounting band is not attached. Please order the band separately.)

BBA3: D-B5/B6/G5 types

BBA4: D-C7/C8/H7 types

"D-G5BAL" and "D-H7BAL" switches are set on the cylinder with the screws above when shipped.  
When a switch only is shipped, "BBA3" or "BBA4" screws are attached.

Note 2) The material is stainless steel on auto switch equipped styles ø20 and ø25.

CJ1

CJP

CJ2

CM2

C85

C76

CG1

MB

MB1

CP95

C95

C92

CA1

CS1

# Series CG1□Q

## Construction

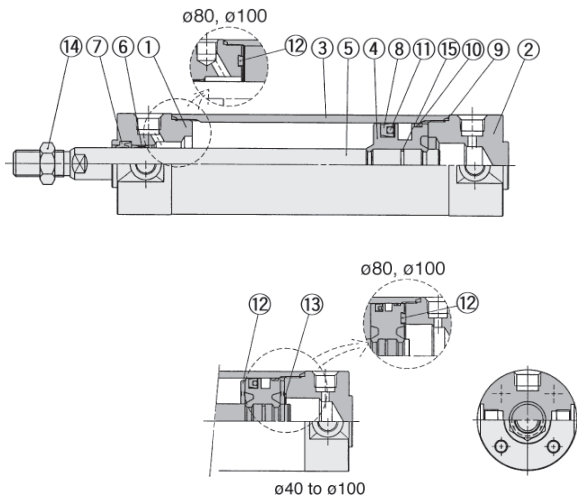

### Component Parts

No.	Description	Material	Note
①	Rod cover	Aluminum alloy	White hard anodized
②	Head cover	Aluminum alloy	White hard anodized
③	Cylinder tube	Aluminum alloy	Hard anodized
④	Piston	Aluminum alloy	Chromated
⑤	Piston rod*	Carbon steel	Hard chrome plated
⑥	Bushing	Oil impregnated sintered alloy	ø40 or larger: Lead bronze cast
⑩	Wear ring	Resin	
⑫	Bumper	Urethane	
⑬	Snap ring	Stainless steel	
⑭	Rod end nut	Rolled steel	Nickel plated
⑮	Piston gasket	NBR	

\* The material is stainless steel on auto switch equipped styles ø20 and ø25.

### Replacement Parts

No.	Description	Material	Bore size (mm)/Part No.							
			ø20	ø25	ø32	ø40	ø50	ø63	ø80	ø100
⑦	Piston seal	NBR	PDU-8Z	PDU-10Z	PDU-12LZ	PDU-16Z	PDU-20Z		PDU-25Z	PDU-30Z
⑧	Rod seal	NBR	GY-20 X 11 X 4	GY-25 X 16 X 4	GY-32 X 21 X 5	GY-40 X 28 X 5	GY-50 X 38 X 5	GY-63 X 51 X 5	GY-80 X 66 X 6	GY-100 X 86 X 6
⑨	Tube gasket	NBR	CM-020-16-123	CM-025-16-124	CM-032-16-126	CM-040-16-127	CM-050-16-128	CM-063-16-129	CM-080-16-152	CM-100-16-153
⑪	Back up O ring	NBR	CM20-1552	CM25-1553	CG032-15-64685	CA40-1546	CA50-1545	CA63-1544	CA80-1549	CM100-1543

\* A rubber magnet is equipped on the piston of the cylinder with auto switch.

### Basic/CG1BQ

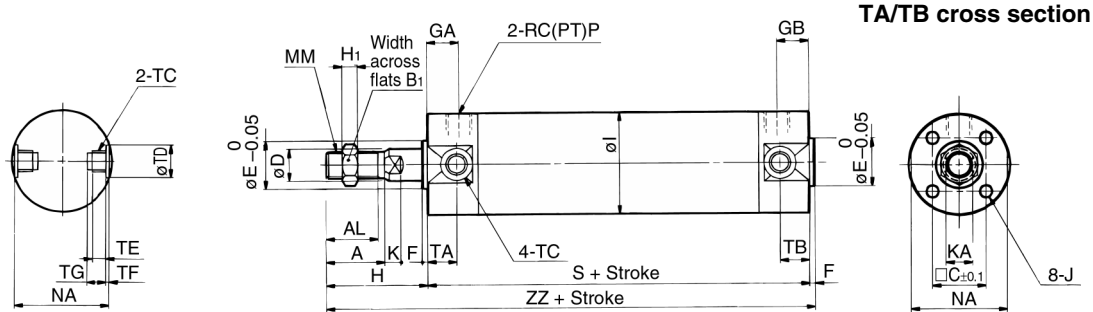

### T/TB cross section (mm)

Bore size (mm)	TC*	TDH9	TE	TF	TG
20	M5	8 <sup>+0.08</sup> <sub>0</sub>	4	0.5	5.5
25	M6 X 0.75	10 <sup>+0.08</sup> <sub>0</sub>	5	1	6.5
32	M8 X 1.0	12 <sup>+0.08</sup> <sub>0</sub>	5.5	1	7.5
40	M10 X 1.25	14 <sup>+0.08</sup> <sub>0</sub>	6	1.25	8.5
50	M12 X 1.25	16 <sup>+0.08</sup> <sub>0</sub>	7.5	2	10
63	M14 X 1.5	18 <sup>+0.08</sup> <sub>0</sub>	11.5	3	14.5

\* Trunnion mounting taps with width across flats NA are not attached for bore sizes ø80 and ø100.

Bore (mm)	Stroke range (mm)	A	AL	B <sub>1</sub>	C	D	E	F	GA	GB	H	H <sub>1</sub>	I	J	K	KA	MM	NA	P	S	TA	TB	ZZ
20	Up to 350	18	15.5	13	14	8	12	2	12	12	35	5	26	M4 Depth 7	5	6	M8	24	1/8	77	11	11	114
25	Up to 400	22	19.5	17	16.5	10	14	2	12	12	40	6	31	M5 Depth 7.5	5.5	8	M10 X 1.25	29	1/8	77	11	11	119
32	Up to 450	22	19.5	13	20	12	18	2	12	12	40	6	38	M5 Depth 8	5.5	10	M10 X 1.25	35.5	1/8	79	11	11	121
40	Up to 800	30	27	19	26	16	25	2	13	13	50	8	47	M6 Depth 12	6	14	M14 X 1.5	44	1/8	87	12	12	139
50	Up to 1200	35	32	27	32	20	30	2	14	14	58	11	58	M8 Depth 16	7	18	M18 X 1.5	55	1/4	102	13	13	162
63	Up to 1200	35	32	27	38	20	32	2	14	14	58	11	72	M10 Depth 16	7	18	M18 X 1.5	69	1/4	102	13	13	162
80	Up to 1400	40	37	32	50	25	40	3	20	20	71	13	89	M10 Depth 22	10	22	M22 X 1.5	80	3/8	122	—	—	196
100	Up to 1500	40	37	41	60	30	50	3	20	20	71	16	110	M12 Depth 22	10	26	M26 X 1.5	100	1/2	122	—	—	196

# Low Friction: Double Acting Single Rod *Series CG1□Q*

## With Mounting Bracket

### Axial foot/CG1LQ

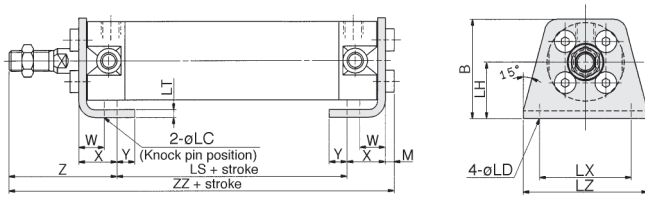

### Axial foot

Bore (mm)	(mm)													Z	ZZ
	B	LC	LD	LH	LS	LT	LX	LZ	M	W	X	Y	Without rod boot		
20	34	4	6	20	53	3	32	44	3	10	15	7	47	118	
25	38.5	4	6	22	53	3	36	49	3.5	10	15	7	52	123.5	
32	45	4	6.6	25	53	3	44	58	3.5	10	16	8	53	125.5	
40	54.5	4	6.6	30	60	3	54	71	4	10	16.5	8.5	63.5	144	
50	70.5	5	9	40	67	4.5	66	86	5	17.5	22	11	75.5	169.5	
63	82.5	5	11	45	67	4.5	82	106	5	17.5	22	13	75.5	169.5	
80	101	6	11	55	74	4.5	100	125	5	20	28.5	14	95	202.5	
100	121	6	14	65	74	6	120	150	7	20	30	16	95	206	

### Front flange/CG1FQ

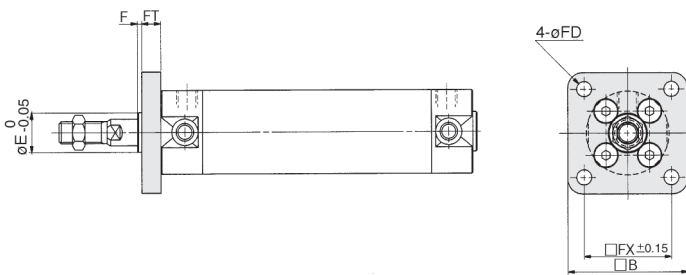

### Flange

Bore (mm)	Stroke range		(mm)							Rear flange ZZ
	Front	Rear	B	E	F	FX	FD	FT	Without rod boot	
20	Up to 350	Up to 200	40	12	2	28	5.5	6	120	
25	Up to 400	Up to 300	44	14	2	32	5.5	7	126	
32	Up to 450	Up to 300	53	18	2	38	6.6	7	128	
40	Up to 800	Up to 500	61	25	2	46	6.6	8	147	
50	Up to 1200	Up to 600	76	30	2	58	9	9	171	
63	Up to 1200	Up to 600	92	32	2	70	11	9	171	
80	Up to 1400	Up to 750	104	40	3	82	11	11	207	
100	Up to 1500	Up to 750	128	50	3	100	14	14	210	

Note) End boss is machined on the flange for øE.

### Rear flange/CG1GQ

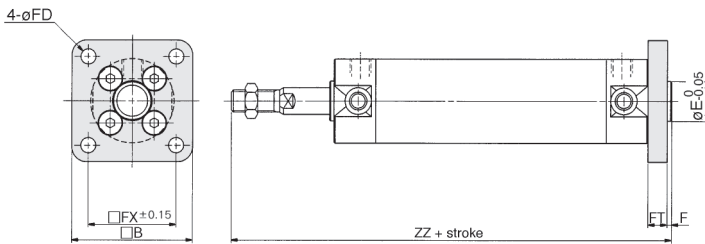

### Front trunnion/CG1UQ

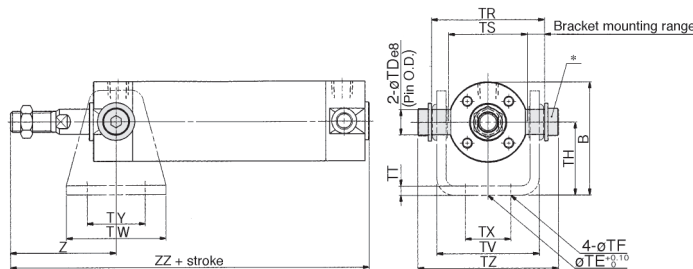

### Trunnion

Bore (mm)	Stroke range		(mm)									
	Front	Rear	B	TDe8	TE	TF	TH	TR	TS	TT	TV	
20	Up to 200	Up to 200	38	8 <sup>-0.025</sup> <sub>-0.047</sub>	10	5.5	25	39	28	3.2	35.8	
25	Up to 300	Up to 300	45.5	10 <sup>-0.025</sup> <sub>-0.047</sub>	10	5.5	30	43	33	3.2	39.8	
32	Up to 300	Up to 300	54	12 <sup>-0.032</sup> <sub>-0.059</sub>	10	6.6	35	54.5	40	4.5	49.4	
40	Up to 500	Up to 500	63.5	14 <sup>-0.032</sup> <sub>-0.059</sub>	10	6.6	40	65.5	49	4.5	58.4	
50	Up to 600	Up to 600	79	16 <sup>-0.032</sup> <sub>-0.059</sub>	20	9	50	80	60	6	72.4	
63	Up to 600	Up to 600	96	18 <sup>-0.032</sup> <sub>-0.059</sub>	20	11	60	98	74	8	90.4	

Bore (mm)	TW	TX	TY	TZ	Front		Rear	
					Z		ZZ	
					Without rod boot		Without rod boot	
20	42	16	28	47.6	46	101	122	
25	42	20	28	53	51	106	127	
32	48	22	28	67.7	51	108	132	
40	56	30	30	78.7	62	125	153	
50	64	36	36	98.6	71	147	179	
63	74	46	46	119.2	71	147	184	

\* Consists of pins, flat washer and hexagon socket head cap bolt.  
Note) Refer to p.1.7-11 for pivot bracket.

### Rear trunnion/CG1TQ

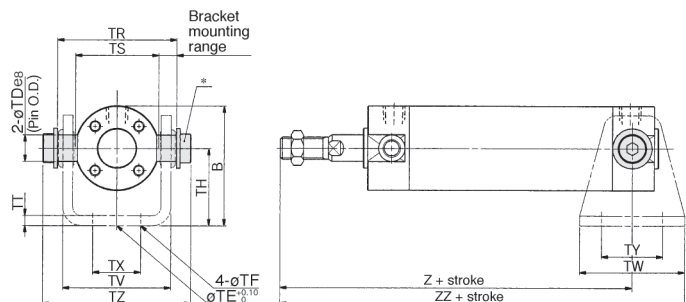

CJ1

CJP

CJ2

CM2

C85

C76

**CG1**

MB

MB1

CP95

C95

C92

CA1

CS1

# Series CG1□Q

## With Mounting Bracket

### Clevis/CG1DQ

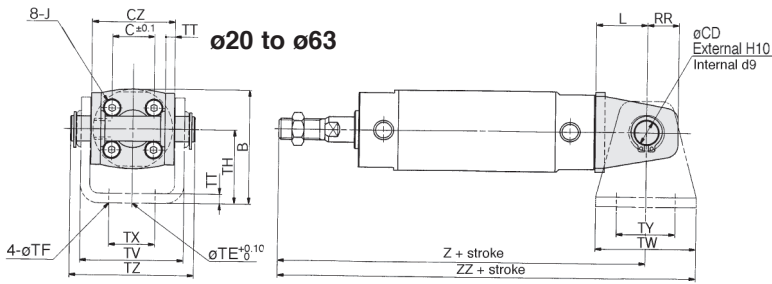

(The above shows the case port location is changed by 90 degrees.)

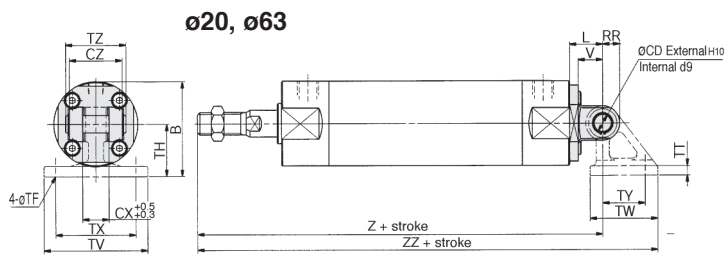

\* Clevis pins and snap rings are attached.

### Clevis

(mm)

Bore (mm)	Stroke range (mm)	B	CD	CX	CZ	L	RR	V	TE	TF	TH
20	Up to 200	38	8	—	29	14	11	—	10	5.5	25
25	Up to 300	45.5	10	—	33	16	13	—	10	5.5	30
32	Up to 300	54	12	—	40	20	15	—	10	6.6	35
40	Up to 500	63.5	14	—	49	22	18	—	10	6.6	40
50	Up to 600	79	16	—	60	25	20	—	20	9	50
63	Up to 600	96	18	—	74	30	22	—	20	11	60
80	Up to 750	99.5	18	28	56	35	18	26	—	11	55
100	Up to 750	120	22	32	64	43	22	32	—	13.5	65

Bore (mm)	TT	TV	TW	TX	TY	TZ	Z	ZZ	Pin part No.
20	3.2	35.8	42	16	28	43.4	126	147	CD-G02
25	3.2	39.8	42	20	28	48	133	154	CD-G25
32	4.5	49.4	48	22	28	59.4	139	163	CD-G03
40	4.5	58.4	56	30	30	71.4	159	187	CD-G04
50	6	72.4	64	36	36	86	185	217	CD-G05
63	8	90.4	74	46	46	105.4	190	227	CD-G06
80	11	110	72	85	45	64	228	286.5	IY-G08
100	12	130	93	100	60	72	236	312.5	IY-G10

Note) \*Refer to p.1.7-11 for pivot bracket.