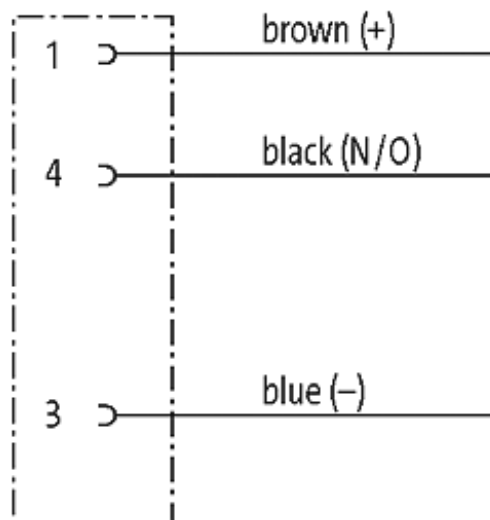
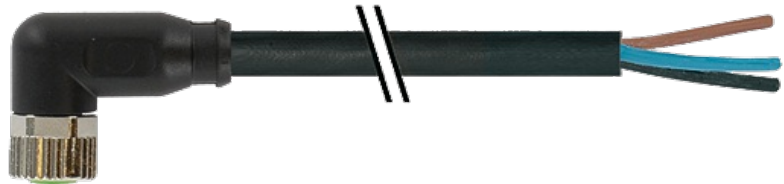

**M8 female 90° with cable**

PVC 3x0.25 bk UL/CSA 25m

M8  
Female 90°  
3-pole

Plastic housings with good resistance against chemicals and oils. The resistance to aggressive media should be individually tested for your application. Further details on request. Further cable lengths on request.

**[Link to Product](#)****Illustration**

# Female

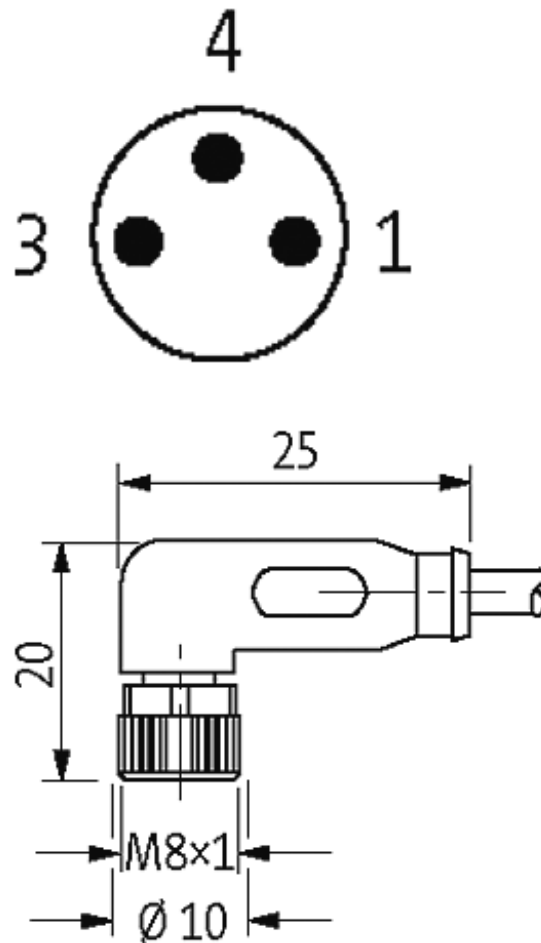

Product may differ from Image

## Approvals



\* only for products with UL/CSA approved cable

## Form

08081

## Technical Data

Operating voltage	max. 60 V AC/DC
Operating current per contact	max. 4 A
Locking of ports	Screw thread M8 × 1 mm (recommended torque 0.4 Nm) self-securing
Protection	IP67 inserted and tightened (EN 60529)

**Cables**

Cable number	610
No./diameter of wires	3 × 0.25 mm <sup>2</sup>
Wire isolation	PVC (br, bl, bk)
Jacket Color	black
Shore hardness outer jacket	85 ± 5A
Material (jacket)	PVC (UL/CSA)
Outer diameter	approx. 4.5 mm
Bend radius (fixed)	5 × outer Ø
Bend radius (moving)	10 × outer Ø
Temperature range (fixed)	-30...+80 °C
Temperature range (mobile)	-5...+80 °C

**Commercial data**

country of origin	DE
customs tariff number	85444290
minimum order quantity	1