

**Actuator And Sensor Cable / PVC**  
**Connection cable**  
**RSC5T-5/TEG**

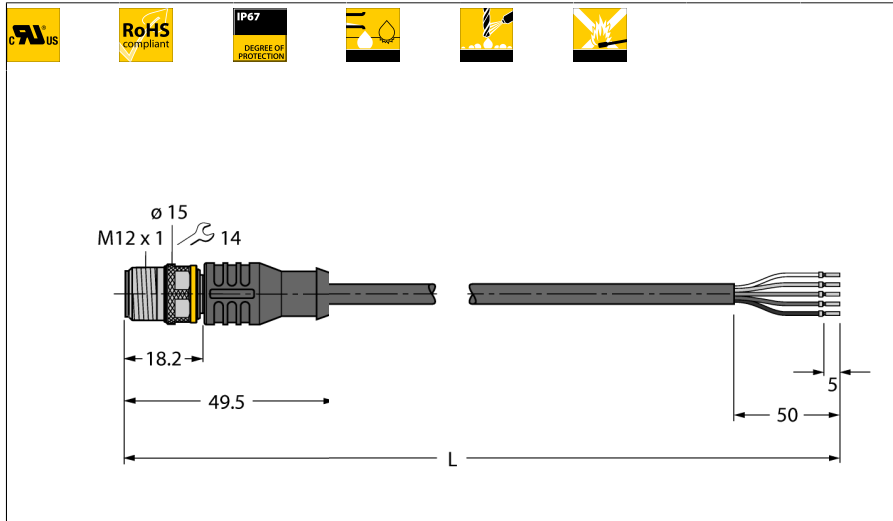

- Male M12, straight, 4-pin + PE
- Sheath material: PVC
- Sheath color: grey
- Resistant to chemicals and oils
- Flame retardant
- Resistant to acids and alkaline solutions
- Resistant to microbes and hydrolysis
- LABS free
- Approval: cULus
- RoHS conform
- Protection class IP67
- Cable length: 5.0 m

**Cable Cross-section**

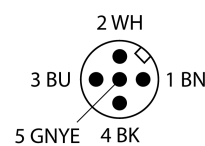
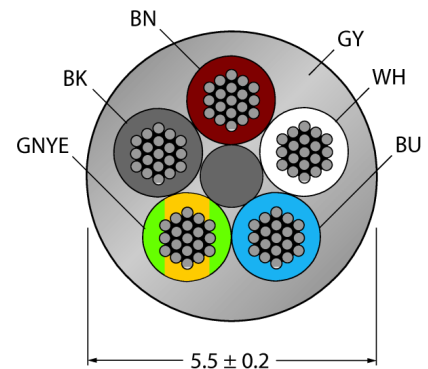

**General information**

Drawing depicts design version including hexagon coupling nut (Production date after CW11/2016).

**Circuit Diagram**

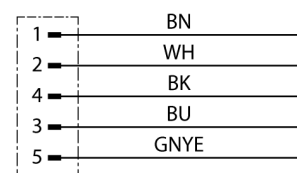

<b>Type designation</b>	RSC5T-5/TEG
Ident no.	6629836
<b>Connector A side</b>	Connector, M12 ♂ 1, Straight
Number of pins	4+PE
Contacts	Brass, CuZn, Gold-plated
Contact carriers	Plastic, TPU, Black
Grip	Plastic, TPU, Black
Coupling nut/screw	Brass, CuZn, Nickel-plated
Protection class	IP67, A + B side screwed together
Mechanical lifespan	> 100 Mating cycles
Pollution degree	3
Tightening torque	0.8 ... 1 Nm (observe max. torque of counter piece!)
<b>General data</b>	
Cable diameter	5.5 ± 0.20mm
Cable length	5 m
Cable quality	PVC
Cable color	Gray
Core insulation	PVC
Core colors	BN, WH, BU, BK, GNYE
Core cross-section	5x0.34mm <sup>2</sup>
Arrangement of strands	42x0.1 mm
<b>Electrical features at +20 °C</b>	
Current	4 A
Rated voltage	60 V
Insulation resistance	> 30.5 MΩ/km
Test voltage	2000 V
Forward resistance	max. 57 Ω/km
<b>Mechanical and chemical properties</b>	
Bending radius (stationary laying)	> 5 x Ø
Bending radius (flexible use)	> 10 x Ø
Ambient temperature	
Stationary	-40...+105°C
In motion	0...+80°C

**Actuator And Sensor Cable / PVC**  
**Connection cable**  
**RSC5T-5/TEG**

**TURCK**

Industrial  
Automation

**Accessories**

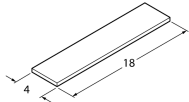
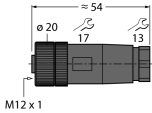
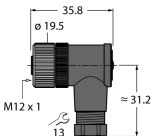
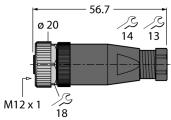
Type code	Ident no.	Description	
Torque-Wrench-Set-AS	6936170	Torque wrench set; handles with adjustable torque 0.4-1.0 Nm, torque wrench for M8 (SW9), fork wrench for M12 (SW 14)	
BLANK-LABEL-FOR-CORDSETS-TEL-TXL	6936206	Label for TEL and TXL cables, length: 18 mm, height: 4 mm, material: polycarbonate (PC), color: white, halogen-free and flame-retardant	
B8151-0	6904601	Field-wireable female connector, M12 $\leftarrow$ 1, straight, 5-pin, screw terminal connection, cable feedthrough 4.0 to 6.0 mm, core cross-section/terminal capacity 0.14 to 0.75 mm <sup>2</sup> , plastic housing, plastic nut	
B8251-0	6904602	Field-wireable female connector, M12 $\leftarrow$ 1, angled, 5-pin, screw terminal connection, cable feedthrough 4.0 to 6.0 mm, core cross-section/terminal capacity 0.14 to 0.75 mm <sup>2</sup> , plastic housing, plastic nut	
BM8151-0	6935888	Field-wireable female connector, M12 $\leftarrow$ 1, straight, 5-pin, screw terminal connection, cable feedthrough 4.0 to 6.0 mm, core cross-section/terminal capacity 0.25 to 0.75 mm <sup>2</sup> , plastic housing, metal nut	

**Actuator And Sensor Cable / PVC**  
**Connection cable**  
**RSC5T-5/TEG**

**TURCK**

Industrial  
Automation

**Accessories**

Type code	Ident no.	Description
BM8251-0	6935890	Field-wireable female connector, M12 (↙) 1, angled, 5-pin, screw terminal connection, cable feedthrough 4.0 to 6.0 mm, core cross-section/terminal capacity 0.25 to 0.75 mm <sup>2</sup> , plastic housing, metal nut

