

* = Mass durch Formkonizität nach unten verringert.
 Freimaß-Toleranz nach DIN 16901-130/
Dimension reduced at bottom due to conical form.
Tolerances to DIN 16901-130.

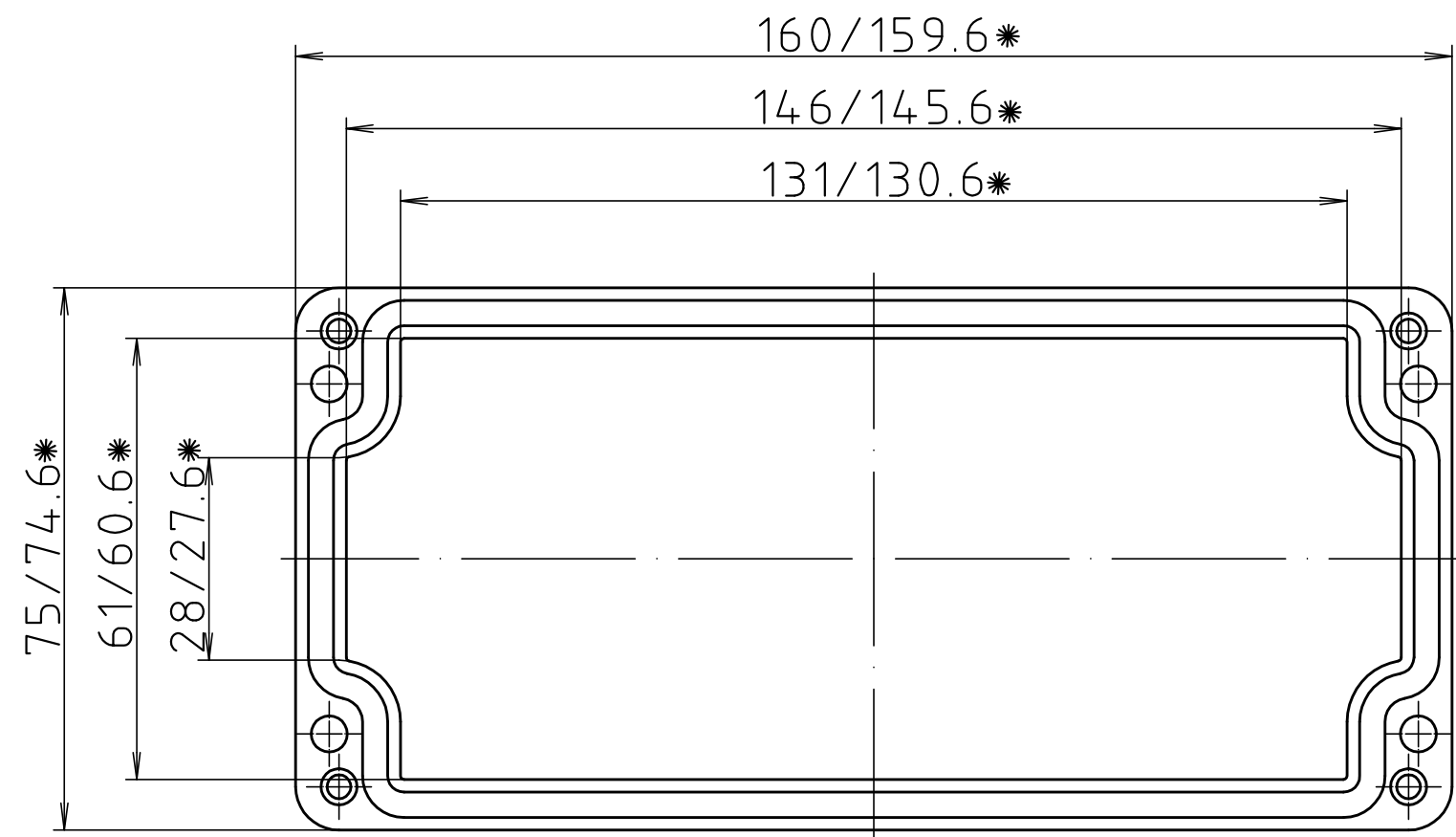

Deckel/
lid

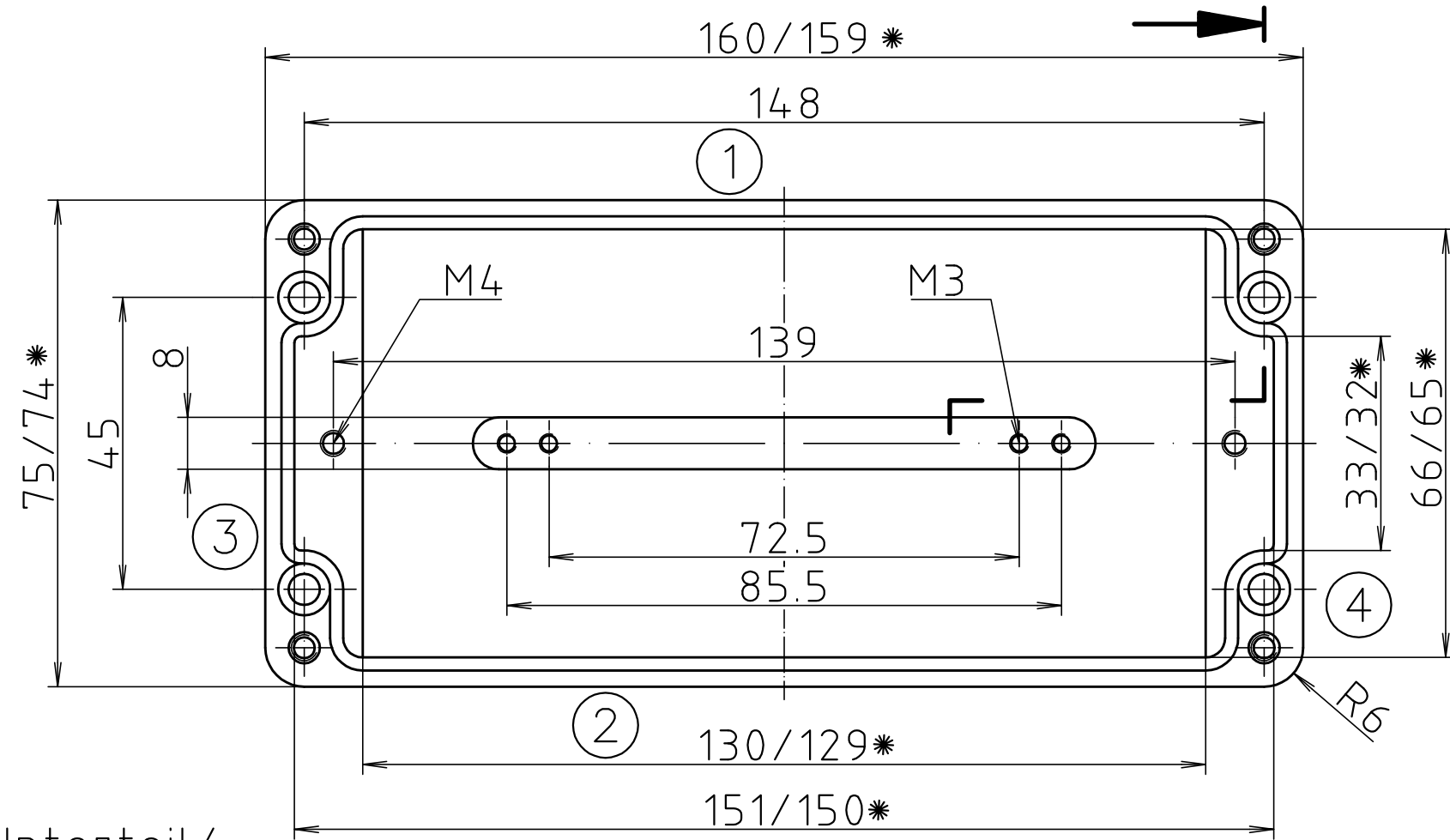

Unterteil/
base

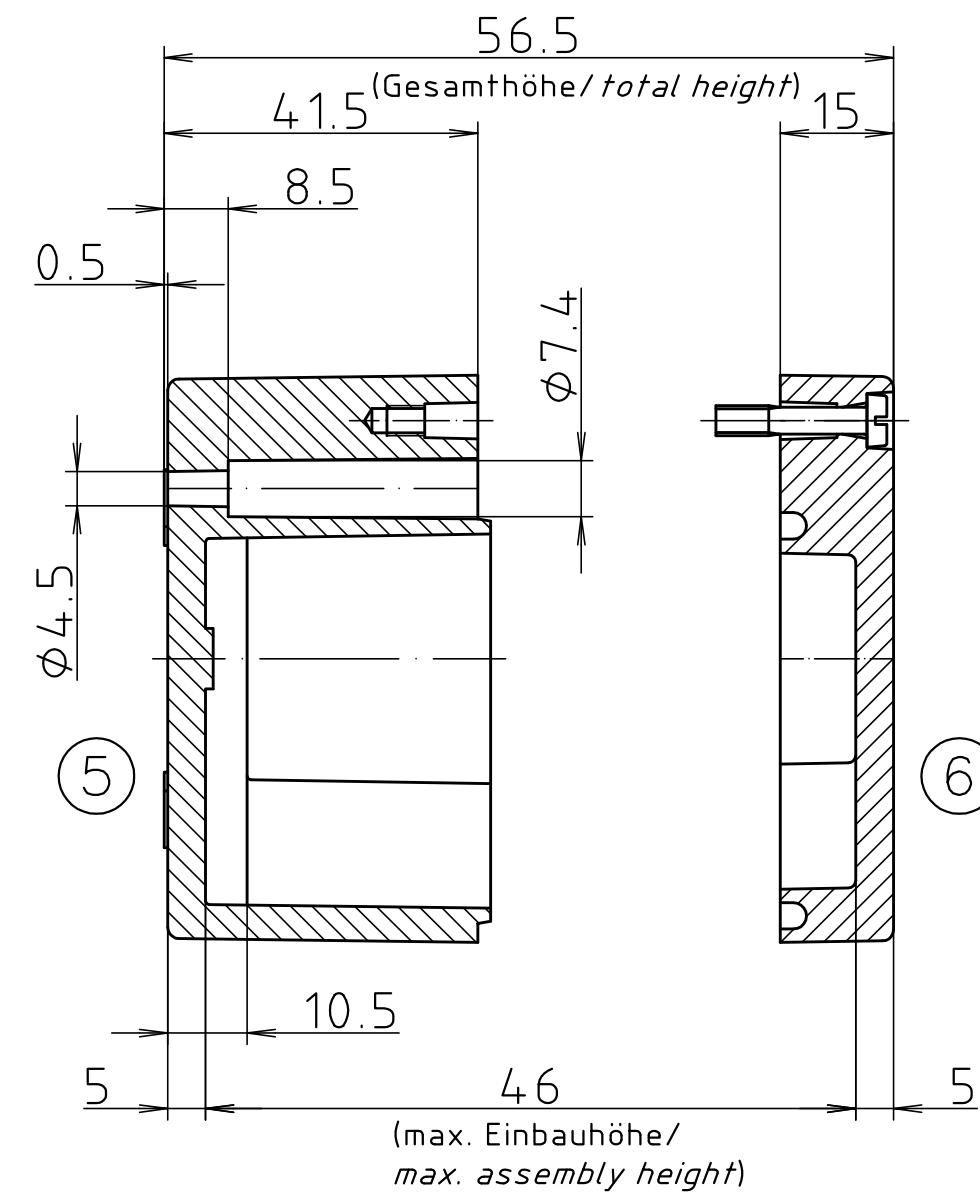

"Schutzvermerk nach DIN ISO 16016 beachten." "Please pay attention to copyright note DIN ISO 16016"

Maßstab/ Scale:	1:1	
Zeichnungs-Nr. / Drawing-No.:	2K 0316.004.01	
Artikel / Article:	P 316 / 2 0816 06	
Katalogzeichnung/ Catalogue drawing		
A.Nr./ Alt-No.:	Datum/ Date:	
DISK: 2 401 755		
Datum/Date: 29.03.2004 NK		

