

## Support Legs

### 22593.2145



#### Product Description

The support legs are universally usable as adjustable legs. The plate is screwed to the threaded pin and nut by a stainless steel fastening screw, and is also glued.

#### Material

##### Grub Screw

- Stainless steel 1.4305

##### Lock nut

- Stainless Steel A2, ISO 4032

##### Pad

- Stainless steel 1.4301, vibratory ground

#### More information

##### Further products

- Support Legs, protected against slipping

#### Drawing

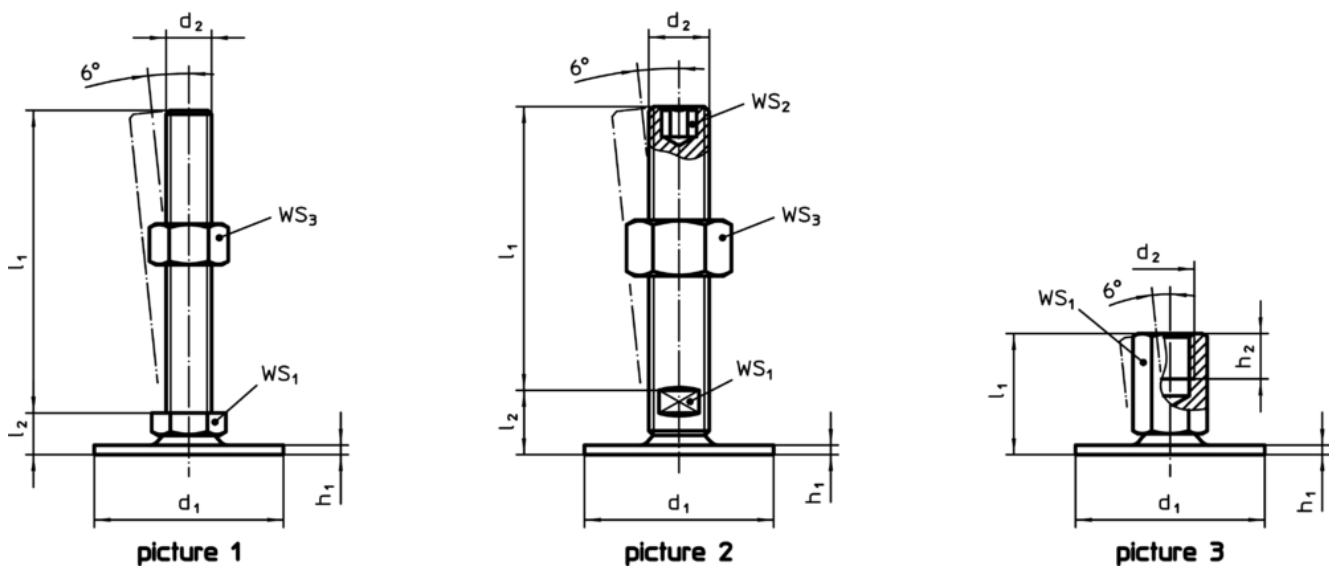

#### Order information

Dimensions					WS <sub>1</sub>	WS <sub>2</sub>	WS <sub>3</sub>		Art. No.
d <sub>1</sub>	d <sub>2</sub>	l <sub>1</sub>	h <sub>1</sub>	l <sub>2</sub>	[mm]	[mm]	[mm]	[g]	
with screw – picture 2, stainless steel									
50	M16	150	2.5	17	12	8	24	273	22593.2145

#### Compliance

##### RoHS compliant

Compliant according to Directive 2011/65/EU and Directive 2015/863

##### Does not contain SVHC substances

No SVHC substances with more than 0.1% w/w contained - SVHC list [REACH] as of 10.06.2022

##### Does not contain Proposition 65 substances

No Proposition 65 substances included

<https://www.P65Warnings.ca.gov/>

##### Free from Conflict Minerals

This product does not contain any substances designated as "conflict minerals" such as tantalum, tin, gold or tungsten from the Democratic Republic of Congo or adjacent countries.