



CIRCUIT BREAKER CURR.SENS.DC 880V AC 400V
10KA, 4POLE, C, 10A MAX. DC 1000V

Model		
product brand name		SENTRON
Product designation		5SY miniature circuit breaker
Design of the product		5SY miniature circuit breakers
General technical data		
Number of poles		4
Number of poles / Note		4P
Tripping characteristic class		C
circuit-breaker / Design		5SY5
Mechanical service life (switching cycles) / typical		20 000
Overvoltage category		3
Voltage		
Insulation voltage		
<ul style="list-style-type: none"> • for DC / Rated value 	V	250
<ul style="list-style-type: none"> • with multi-phase operation / with AC / Rated value 	V	440
Supply voltage		
Supply voltage frequency / Rated value	Hz	50
Protection class		
Protection class IP		IP20, with connected conductors
Energy limiting class		3
Switching capacity		
Switching capacity current		

- for DC / acc. to IEC 60947-2 / Rated value
- acc. to EN 60898 / Rated value

kA	15
kA	10

Dissipation

Active power loss

- for rated value of the current / with AC / in hot operating state / per pole

W	1.1
---	-----

Electricity

Current / with AC / Rated value

A	10
---	----

Product details

Product feature / Touch protection

	Yes
--	-----

Product component

- combined terminal top
- combined terminal bottom

	Yes
	Yes

Product property

- Properties for main switches in accordance with EN 60204-1
- halogen-free
- sealable
- silicon-free

	Yes
	Yes
	Yes
	Yes

Product expansion / can be installed / supplementary devices

	Yes
--	-----

Product function

Product function / neutral conductor switching

	No
--	----

Short circuit

Breaking capacity short-circuit current (I_{cn})

- for DC / acc. to EN 60898-2

kA	10
----	----

Number

Number of test cycles / for environmental testing / acc. to IEC 60068-2-30

	6
--	---

Connections

Connectable conductor cross-section / stranded

- minimum
- maximum

mm ²	0.75
mm ²	35

Connectable conductor cross-section

- solid
 - minimum
 - maximum
- finely stranded / with core end processing
 - minimum
 - maximum

mm ²	0.75
mm ²	35
mm ²	0.75
mm ²	25

AWG number / as coded connectable conductor cross section		
• minimum		14
• maximum		4
Tightening torque [lbf·in] / with screw-type terminals		
• minimum	lbf·in	22
• maximum	lbf·in	26
Tightening torque / with screw-type terminals		
• minimum	N·m	2.5
• maximum	N·m	3
Position / of power supply cord		Any

Mechanical Design

Height	mm	90
Width	mm	72
Depth	mm	76
mounting position		any
Installation depth	mm	70
Number of width units		4
Mounting type		Quick assembly system

Environmental conditions

Influence of the surrounding temperature		Max. 95% humidity
Shock resistance / acc. to IEC 60068-2-27		150m/s ² at 11ms half-sine
Vibration resistance / acc. to IEC 60068-2-6		50m/s ² at 25 to 150Hz and 60m/s ² at 35Hz (4sec)
Ambient temperature		
• minimum	°C	-25
• maximum	°C	55
• during storage / minimum	°C	-40
• during storage / maximum	°C	75

Certificates

Equipment marking / acc. to DIN EN 61346-2		F
--	--	---

General Product Approval	Declaration of Conformity	Test Certificates	other
---------------------------------	----------------------------------	--------------------------	--------------



[other](#)

[other](#)

Further information

Information- and Downloadcenter (Catalogs, Brochures,...)

<http://www.siemens.com/lowvoltage/catalogs>

Industry Mall (Online ordering system)

<https://eb.automation.siemens.com/mall/en/WW/Catalog/Product/5SY54107>

Service&Support (Manuals, Certificates, Characteristics, FAQs,...)

<http://support.automation.siemens.com/WW/view/en/5SY54107/all>

Image database (product images, 2D dimension drawings, 3D models, device circuit diagrams, ...)

http://www.automation.siemens.com/bilddb/cax_en.aspx?mlfb=5SY54107

CAX-Online-Generator

<http://www.siemens.com/cax>

Tender specifications

<http://ausschreibungstexte.siemens.com/tiplv>

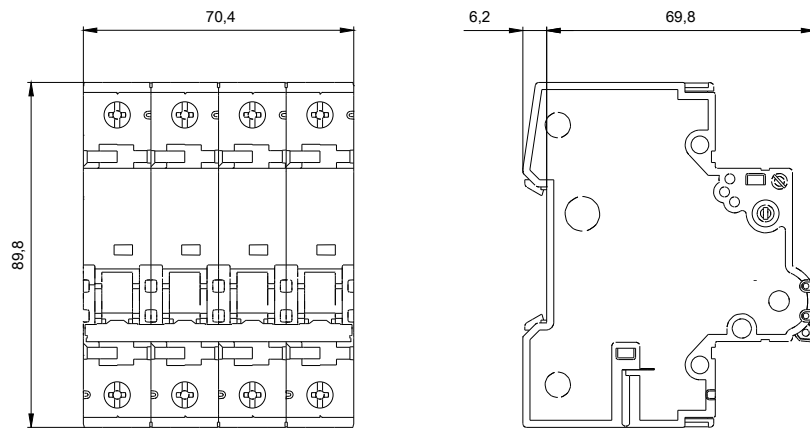

last modified:

11.03.2015