

Spur Gears Made From Plastic with Steel Core, Milled, Straight Teeth

Material: Plastic PA 12 G, white (natural color) or black.
Steel core: Choice of steel or stainless steel 1.4305 (AISI 303).



Tooth quality 8e25 DIN 3967.

Temperature range -60°C to +120° C, short periods 150° C.

- Special plastic with excellent material properties.
- Enables snugly fitting, high strength shaft-hub connection.
- Optimal force transmission due to cylindrical contact area.
- Light, silent and clean, with excellent dry running properties.

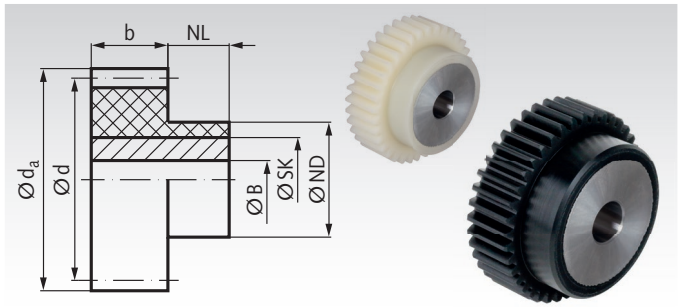

Ordering Details: e.g.: Product No. 218 550 25, spur gear, module 1.5, 25 teeth, white

Module 1.5 Tooth width b = 17 mm

Product No. Steel Core white	Product No. Steel Core black	Product No. Stainless Core white	Product No. Stainless Core black	Number of teeth	b mm	d _a mm	d mm	NL mm	ND mm	SK mm	BH7 mm	perm.MD* Nm	Weight g
218 550 25	218 552 25	218 950 25	218 952 25	25	17	40,5	37,5	13	33	25	10	2,1	112
218 550 30	218 552 30	218 950 30	218 952 30	30	17	48	45	13	35	25	10	3,2	122
218 550 32	218 552 32	218 950 32	218 952 32	32	17	51	48	13	35	25	10	3,7	125
218 550 36	218 552 36	218 950 36	218 952 36	36	17	57	54	13	45	35	10	4,9	238
218 550 40	218 552 40	218 950 40	218 952 40	40	17	63	60	13	50	40	10	6,3	312
218 550 45	218 552 45	218 950 45	-	45	17	70,5	67,5	13	50	40	10	8,3	325
218 550 48	-	218 950 48	-	48	17	75	72	13	55	45	10	9,0	407
218 550 50	218 552 50	218 950 50	218 952 50	50	17	78	75	13	55	45	10	9,4	413
218 550 56	218 552 56	218 950 56	-	56	17	87	84	13	65	55	15	10,6	582
218 550 60	218 552 60	218 950 60	218 952 60	60	17	93	90	13	70	60	15	11,4	695
218 550 64	-	218 950 64	-	64	17	99	96	13	70	60	15	12,2	710
218 550 70	-	218 950 70	-	70	17	108	105	13	70	60	15	13,4	735
218 550 72	-	218 950 72	-	72	17	111	108	13	80	70	15	13,8	967
218 550 80	218 552 80	218 950 80	-	80	17	123	120	13	85	75	20	15,3	1096
218 550 90	-	218 950 90	-	90	17	138	135	13	90	80	20	17,1	1281
218 551 00	-	218 951 00	-	100	17	153	150	13	110	90	20	19,0	1652
218 551 20	-	218 951 20	-	120	17	183	180	13	120	90	20	22,7	2114

Module 2 Tooth width b = 20 mm

Product No. Steel Core white	Product No. Steel Core black	Product No. Stainless Core white	Product No. Stainless Core black	Number of teeth	b mm	d _a mm	d mm	NL mm	ND mm	SK mm	BH7 mm	perm.MD* Nm	Weight g
231 550 18	231 552 18	231 950 18	231 952 18	18	20	40	36	15	31	25	10	2,1	127
231 550 20	231 552 20	231 950 20	231 952 20	20	20	44	40	15	35	25	10	2,7	135
231 550 24	231 552 24	231 950 24	231 952 24	24	20	52	48	15	40	30	10	4,2	189
231 550 25	231 552 25	231 950 25	231 952 25	25	20	54	50	15	45	35	10	4,6	271
231 550 28	-	231 950 28	231 952 28	28	20	60	56	15	45	35	15	6,1	254
231 550 30	231 552 30	231 950 30	231 952 30	30	20	64	60	15	50	40	15	7,2	338
231 550 32	231 552 32	231 950 32	231 952 32	32	20	68	64	15	50	40	15	8,4	345
231 550 35	-	231 950 35	231 952 35	35	20	74	70	15	55	45	15	10,4	444
231 550 36	231 552 36	231 950 36	231 952 36	36	20	76	72	15	55	45	15	11,1	448
231 550 40	231 552 40	231 950 40	231 952 40	40	20	84	80	15	65	55	20	14,3	631
231 550 45	231 552 45	231 950 45	231 952 45	45	20	94	90	15	70	60	20	17,6	774
231 550 48	-	231 950 48	-	48	20	100	96	15	70	60	20	19,0	792
231 550 50	231 552 50	231 950 50	231 952 50	50	20	104	100	15	75	65	20	19,8	930
231 550 56	-	231 950 56	-	56	20	116	112	15	80	70	20	23,8	1105
231 550 60	231 552 60	231 950 60	-	60	20	124	120	15	85	75	20	24,0	1280
231 550 64	-	231 950 64	-	64	20	132	128	15	90	80	20	25,7	1467
231 550 70	-	231 950 70	-	70	20	144	140	15	90	80	25	28,1	1469
231 550 72	-	231 950 72	-	72	20	148	144	15	90	80	25	28,8	1487
231 550 80	231 552 80	231 950 80	-	80	20	164	160	15	100	90	25	32,0	1905
231 550 90	-	231 950 90	-	90	20	184	180	15	110	90	25	36,1	2393
231 551 00	-	231 951 00	-	100	20	204	200	15	120	110	25	40,1	2933
231 551 20	-	231 951 20	-	120	20	244	240	15	130	120	25	47,8	3671

* Basis of calculations see page 235.

On request:

Other versions and components made from PA 6 G / PA 12 G without core or with aluminium core.

Plastic PA 12 G

Produced using the vertical casting process.
 High-molecular, high crystalline and almost stress free.
 Very low moisture absorption, excellent dimensional stability.
 High viscosity even at very low temperatures.
 Very good mechanical and chemical resistance.

Steel core

Core with cylindrical body surface, knurled, permanently cast-in.
 As standard made from normal steel or 1.4305.
 On request in aluminium.
 Bore tolerance H7, finished after casting.
 The steel core allows the transfer of high torque even for small shaft diameters and correspondingly small parallel key connections.