

85°C

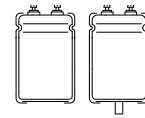

GM



SCREW TERMINALS

HIGH CV PRODUCT

LONG LIFE 8000 H @ 85 °C

■ FEATURES

- All internal contacts welded
- High capacitance
- High CV product
- Low inductance ESL

■ APPLICATIONS

- Computer
- Inverter/drives
- Traction
- Welding

RoHS compliant  
REACH compliant

■ GENERAL SPECIFICATIONS

Items	Characteristics
Rated capacitance range $C_R$	390... 3.300.000 $\mu$ F
Capacitance tolerance	$\pm 20\%$
Rated voltage range U	16 ... 500 V
Surge voltage $U_S$	$U_R \leq 315$ V: $U_S = 1,15 U_R$ ; $U_R > 315$ V: $U_S = 1,10 U_R$
Max. reverse voltage	2 V / 20 nH
Category temperature range	- 40°C ... + 85 °C
Leakage current $I_L$ after 5 min @ $U_R$	$\leq 0,008 * C_R [\mu F] * U_R [V] + 6 \mu A [\mu A]$
Useful life 8000 h @ 85 °C ; $U_R$ ; $I_R$	Requirements $\Delta C/C \leq 30\%$ of initial value ; ESR $\leq 300\%$ of specified ; limit $I_L \leq$ specified limit
Endurance test 4000 h @ 85 °C , $U_R$	Requirements $\Delta C/C \leq 20\%$ of initial value ; ESR $\leq 130\%$ of specified ; limit $I_L \leq$ specified limit
Climatic category IEC 60068	40/085/56
Voltage proof of the external insulation	$\geq 2500$ V AC
Sectional specification	IEC 60384-4

Different voltages and capacitance combinations are available on request. Also in small lots.

Stand: 12/2019



■ DRAWINGS FOR SERIES GMA AND GMB

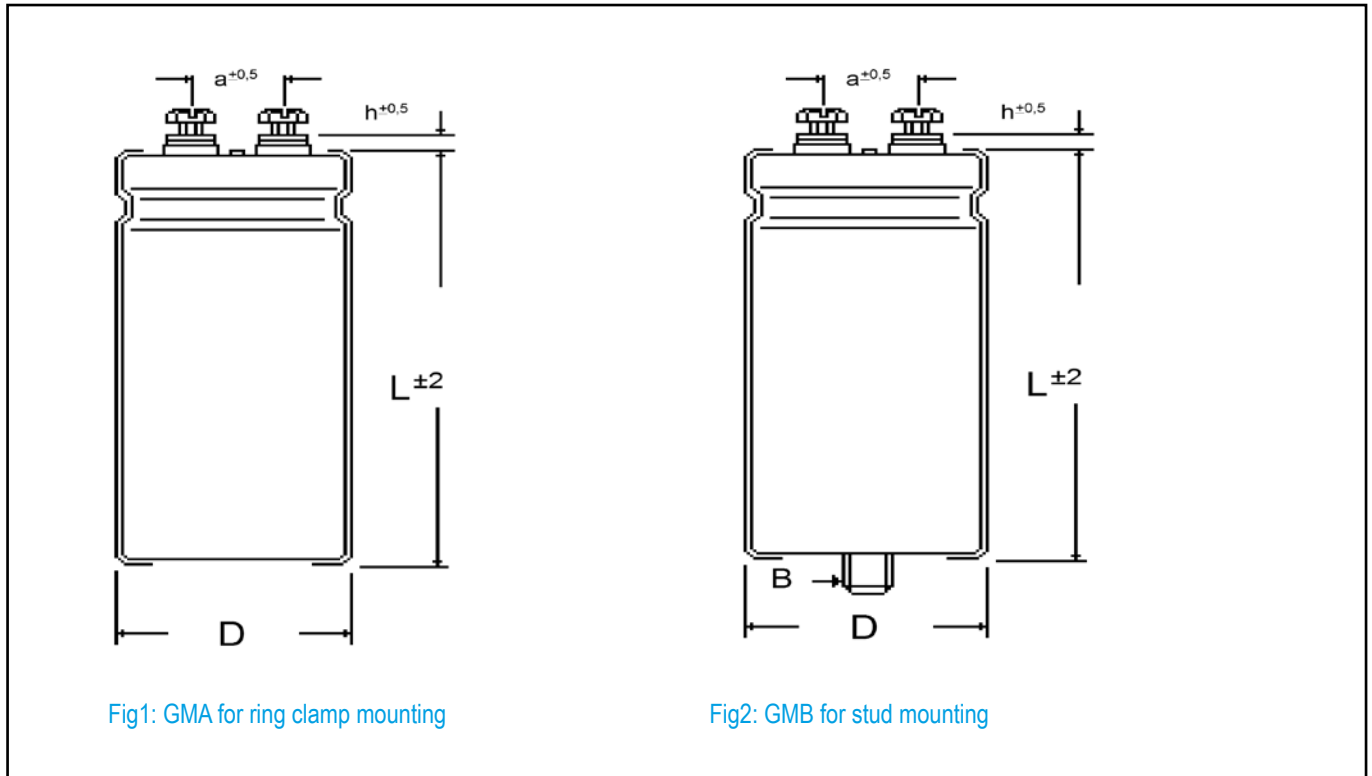

■ DIMENSIONS AND MECHANICAL DATA

Dimensions, case with insulation sleeve				Connecting terminals		Mounting stud, GMB only	
D [mm]	Case length L available in 5 mm [mm]	h [mm]	a [mm]	Thread	Max. torque [Nm]	B	Max. torque [Nm]
35	40 ... 120	6	13	M5	2,0	M8 x 12	4,0
40	40 ... 120	5	18	M5	2,0	M8 x 12	4,0
50	40 ... 120	5	22	M5	2,0	M12 x 16	10,0
65	40 ... 180	5	28,5	M5	2,0	M12 x 16	10,0
75	40 ... 230	5	31,7	M5 ; M6	2,0 ; 2,5	M12 x 16	10,0
90	40 ... 230	5	31,7	M6	2,5	M12 x 16	10,0

GMA: connecting screws M5 or M6

GMB: connecting screws M5 or M6 + mounting nut M8 or M12

Remarks: Further mounting accessoires like clamps, nylon cup nuts and insulation disks on request, see "accessory equipment".

Stand: 12/2019

85°C

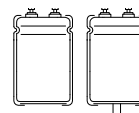

GM

ELECTRICAL DATA AND ORDERING CODE FOR SERIES GM

Rated voltage $U_R$ [V]	Rated cap. $C_R$ [μF]	Case size D x L [mm]	Typ. ESR 100 Hz, 20°C [mΩ]	Ripple current IR~ 100 Hz, 85°C [A]	Order code	
					Plain base: GMA...	
16	82000	35x55	6	9,0	82301635055	
	120000	35x70	4	12,0	12401635070	
	120000	40x55	4	11,1	12401640055	
	150000	35x80	3	14,2	15401635080	
	150000	40x70	3	13,7	15401640070	
	180000	35x100	3	17,0	18401635100	
	180000	40x80	3	15,8	18401640080	
	180000	45x70	3	15,0	18401645070	
	220000	40x100	2	19,1	22401640100	
	220000	50x70	2	17,7	22401650070	
	270000	45x100	2	21,1	27401645100	
	270000	50x80	2	20,6	27401650080	
	390000	50x100	1	27,0	39401650100	
	470000	65x80	1	35,6	47401665080	
	560000	65x100	1	42,1	56401665100	
	820000	65x130	1	56,5	82401665130	
	820000	75x100	1	44,1	82401675100	
	1000000	75x115	1	46,5	10501675115	
	1200000	75x145	1	50,8	12501675145	
	1500000	75x165	1	53,5	15501675165	
	1800000	90x148	1	57,3	18501690148	
	2200000	75x225	1	61,0	22501675225	
	2200000	90x170	1	60,4	22501690170	
	2700000	90x220	1	67,1	27501690220	
	3300000	90x230	1	68,3	33501690230	
	25	33000	35x55	14	5,9	33302535055
		47000	35x70	9	7,8	47302535070
		47000	40x55	9	7,2	47302540055
56000		35x80	8	9,0	56302535080	
68000		40x70	7	9,5	68302540070	
82000		35x100	5	11,9	82301635100	
68000		40x80	7	10,0	68302540080	
82000		45x70	5	10,5	82302545070	
68000		40x100	7	11,0	68302540100	
100000		50x70	4	12,3	10402550070	
120000		45x100	4	14,6	12402545100	
120000		50x80	4	14,2	12402550080	
150000		50x100	3	17,3	15402550100	
180000		65x80	3	22,4	18402565080	
270000		65x100	2	29,8	27402565100	
330000		75x100	1	28,5	33402575100	
330000		65x130	1	36,4	33402565130	
390000		75x115	1	32,6	39402575115	
560000		75x145	1	42,7	56402575145	
560000		75x165	1	45,0	56402575165	
820000		90x148	1	58,2	82402590148	
820000		75x225	1	62,0	82402575225	

Rated voltage $U_R$ [V]	Rated cap. $C_R$ [μF]	Case size D x L [mm]	Typ. ESR 100 Hz, 20°C [mΩ]	Ripple current IR~ 100 Hz, 85°C [A]	Order code	
					Plain base: GMA...	
25	820000	90x170	1	61,5	82402590170	
	1200000	90x220	1	82,6	12502590220	
	1500000	90x230	1	94,0	15502590230	
40	18000	35x55	21	4,7	18304035055	
	22000	40x55	17	5,3	22304040055	
	27000	35x70	14	6,4	27304035070	
	33000	35x80	12	7,4	33304035080	
	33000	40x70	12	7,2	33304040070	
	39000	35x100	10	8,9	39304035100	
	39000	40x80	10	8,2	39304040080	
	39000	45x70	10	7,8	39304045070	
	56000	50x70	7	10,0	56304050070	
	56000	40x100	7	10,8	56304040100	
	68000	50x80	6	11,6	68304050080	
	68000	45x100	6	11,8	68304045100	
	82000	50x100	5	13,8	82304050100	
	100000	65x80	4	18,3	10404065080	
	150000	65x100	3	24,4	15404065100	
	180000	75x100	2	23,1	18404075100	
	180000	65x130	2	29,6	18404065130	
	220000	75x115	2	26,9	22404075115	
	270000	75x145	1	32,6	27404075145	
	330000	75x165	1	38,0	33404075165	
	470000	90x148	1	48,5	47404090148	
	470000	75x225	1	51,6	47404075225	
	560000	90x170	1	55,8	56404090170	
	680000	90x220	1	68,3	68404090220	
	680000	90x230	1	69,6	68404090230	
	63	8200	35x55	35	3,7	82206335055
		12000	40x55	24	4,6	12306340055
		15000	35x70	19	5,5	15306335070
18000		35x80	16	6,3	18306335080	
18000		40x70	16	6,1	18306340070	
18000		35x100	16	6,9	18306335100	
22000		40x80	13	7,1	22306340080	
22000		45x70	13	6,8	22306345070	
27000		50x70	11	8,0	27306350070	
27000		40x100	11	8,6	27306340100	
33000		50x80	9	9,3	33306350080	
33000		45x100	9	9,5	33306345100	
39000		50x100	7	11,0	39306350100	
47000		65x80	6	14,5	47306365080	
68000		65x100	4	19,0	68306365100	
82000		75x100	3	18,0	82306375100	
100000		65x130	3	25,5	10406365130	
120000		75x115	2	22,9	12406375115	
150000		75x145	2	28,1	15406375145	

Stand: 12/2019

85°C

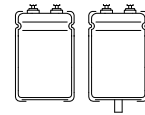

GM

Rated voltage $U_R$ [V]	Rated cap. $C_R$ [μF]	Case size D x L [mm]	Typ. ESR 100 Hz, 20°C [mΩ]	Ripple current IR~ 100 Hz, 85°C [A]	Order code	
					Plain base: GMA...	
					Stud mounting: GMB...	
63	180000	75x165	2	32,4	18406375165	
	220000	90x148	1	38,3	22406390148	
	220000	75x225	1	40,8	22406375225	
	270000	90x170	1	44,8	27406390170	
	330000	90x220	1	54,9	33406390220	
	390000	90x230	1	60,9	39406390230	
80	6800	35x55	47	3,2	68208035055	
	8200	40x55	39	3,8	82208040055	
	10000	35x70	32	4,2	10308035070	
	12000	35x80	27	4,6	12308035080	
	12000	40x70	27	4,7	12308040070	
	15000	35x100	21	6,0	15308035100	
	15000	40x80	21	5,6	15308040080	
	15000	45x70	21	5,3	15308045070	
	18000	40x100	18	6,2	18308040100	
	18000	50x70	18	6,2	18308050070	
	22000	45x100	14	7,9	22308045100	
	22000	50x80	14	7,2	22308050080	
	27000	50x100	12	8,7	27308050100	
	39000	65x80	8	12,6	39308065080	
	47000	65x100	7	15,0	47308065100	
	68000	65x130	5	15,7	68308065130	
	68000	75x100	5	19,7	68308075100	
	82000	75x115	4	18,0	82308075115	
	100000	75x145	3	21,7	10408075145	
	120000	75x165	3	25,1	12408075165	
	150000	90x148	2	30,0	15408090148	
	180000	75x225	2	35,0	18408075225	
	180000	90x170	2	34,7	18408090170	
	220000	90x220	1	42,6	22408090220	
	270000	90x230	1	48,0	27408090230	
	100	3300	35x55	48	3,1	33210035055
4700		35x70	34	4,1	47210035070	
4700		40x55	34	3,8	47210040055	
5600		35x80	28	4,7	56210035080	
5600		40x70	28	4,6	56210040070	
6800		35x100	23	5,7	68210035100	
6800		40x80	23	5,3	68210040080	
8200		45x70	19	5,5	82210045070	
10000		50x70	16	6,5	10310050070	
10000		40x100	16	7,1	10310040100	
12000		45x100	13	7,7	12310045100	
12000		50x80	13	7,5	12310050080	
15000		50x100	11	9,2	15310050100	
18000		65x80	9	12,1	18310065080	
22000		65x100	7	14,5	22310065100	
27000		75x100	6	13,9	27310075100	
33000		65x130	5	19,6	33310065130	
39000		75x115	4	17,6	39310075115	

Rated voltage $U_R$ [V]	Rated cap. $C_R$ [μF]	Case size D x L [mm]	Typ. ESR 100 Hz, 20°C [mΩ]	Ripple current IR~ 100 Hz, 85°C [A]	Order code	
					Plain base: GMA...	
					Stud mounting: GMB...	
100	47000	75x145	3	21,1	47310075145	
	56000	75x165	3	24,2	56310075165	
	68000	90x148	2	28,6	68310090148	
	82000	75x225	2	33,4	82310075225	
	82000	90x170	2	33,1	82310090170	
	120000	90x220	1	44,5	12410090220	
	120000	90x230	1	45,3	12410090230	
	160	1800	35x55	62	2,8	18216035055
2200		35x70	51	3,4	22216035070	
2200		40x55	51	3,1	22216040055	
2700		35x80	41	3,9	27216035080	
3300		40x70	34	4,2	33216040070	
3900		35x100	29	5,2	39216035100	
3900		40x80	29	4,8	39216040080	
3900		45x70	29	4,6	39216045070	
4700		40x100	24	5,4	47216040100	
4700		50x70	24	5,7	47216050070	
5600		50x80	20	6,1	56201605080	
6800		45x100	16	6,9	68216045100	
8200		50x100	14	8,1	82216050100	
8200		65x80	14	9,7	82216065080	
12000		65x100	9	12,8	12316065100	
18000		65x130	6	13,7	18316065130	
18000		75x100	6	17,1	18316075100	
18000		75x115	6	14,3	18316075115	
27000		75x145	4	19,1	27316075145	
27000		75x165	4	20,1	27316075165	
39000		90x148	3	25,9	39316090148	
47000		75x225	2	30,2	47316075225	
47000		90x170	2	30,0	47316090170	
56000		90x220	2	36,3	56316090220	
68000		90x230	2	40,7	68316090230	
250		1200	35x55	80	2,4	12225035055
	1500	35x70	64	3,0	15225035070	
	1500	40x55	64	2,8	15225040055	
	1800	35x80	53	3,5	18225035080	
	1800	40x70	53	3,3	18225040070	
	2200	40x80	43	4,1	22225040080	
	2700	35x100	35	4,4	27225035100	
	2700	45x70	35	4,1	27225045070	
	3300	40x100	29	4,9	33225040100	
	3300	50x70	29	5,2	33225050070	
	3900	50x80	24	5,5	39225050080	
	3900	45x100	24	5,7	39225045100	
	5600	50x100	17	7,2	56225050100	
	5600	65x80	17	8,7	56225065080	
	8200	65x100	12	11,4	82225065100	
	12000	65x130	8	12,1	12325065130	
	12000	75x100	8	15,1	12325075100	

Stand: 12/2019

85°C

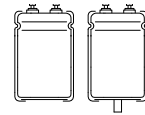

GM

Rated voltage $U_R$ [V]	Rated cap. $C_R$ [μF]	Case size D x L [mm]	Typ. ESR 100 Hz, 20°C [mΩ]	Ripple current IR~ 100 Hz, 85°C [A]	Order code
					Plain base: GMA...
					Stud mounting: GMB...
250	15000	75x115	6	14,1	15325075115
	18000	75x145	5	16,8	18325075145
	18000	75x165	5	17,7	18325075165
	27000	90x148	4	23,2	27325090148
	27000	75x225	4	24,7	27325075225
	27000	90x170	4	24,5	27325090170
	39000	90x220	2	32,7	39325090220
	39000	90x230	2	33,3	39325090230
350	680	35x55	141	1,8	68135035055
	1000	35x70	96	2,3	10235035070
	1000	40x55	96	2,4	10235040055
	1200	35x80	80	2,8	12235035080
	1200	40x70	80	2,7	12235040070
	1500	35x100	64	3,0	15235035100
	1500	40x80	64	3,4	15235040080
	1500	45x70	64	3,3	15235045070
	1800	40x100	53	3,6	18235040100
	1800	50x70	53	3,8	18235050070
	2200	50x80	43	4,2	22235050080
	2200	45x100	43	4,3	22235045100
	2700	50x100	35	5,0	27235050100
	3900	65x80	24	7,2	39235065080
	4700	65x100	20	8,6	47235065100
	5600	75x100	17	8,2	56235075100
	6800	65x130	14	11,5	68235065130
	6800	75x115	14	9,5	68235075115
	8200	75x145	12	11,4	82235075145
	10000	75x165	10	13,2	10335075165
12000	90x148	8	15,5	12335090148	
15000	75x225	6	18,4	15335075225	
15000	90x170	6	18,3	15335090170	
18000	90x220	5	22,2	18335090220	
18000	90x230	5	22,6	18335090230	
400	560	35x55	227	1,4	56140035055
	680	40x55	187	1,7	68140040055
	820	35x70	155	1,8	82140035070
	1000	35x80	127	2,2	10240035080
	1000	40x70	127	2,2	10240040070
	1200	35x100	106	2,5	12240035100
	1200	40x80	106	2,7	12240040080
	1200	45x70	106	2,4	12240045070
	1500	40x100	85	2,8	15240040100
	1500	50x70	85	3,0	15240050070
	1800	50x80	71	3,3	18240050080
	1800	45x100	71	3,3	18240045100
	2200	50x100	58	3,9	22240050100
	3300	65x80	39	5,8	33240065080
	3900	65x100	33	6,8	39240065100
	5600	65x130	23	7,1	56240065130

Rated voltage $U_R$ [V]	Rated cap. $C_R$ [μF]	Case size D x L [mm]	Typ. ESR 100 Hz, 20°C [mΩ]	Ripple current IR~ 100 Hz, 85°C [A]	Order code
					Plain base: GMA...
					Stud mounting: GMB...
400	5600	75x100	23	8,9	56240075100
	6800	75x115	19	8,2	68240075115
	8200	75x145	16	9,8	82240075145
	10000	75x165	13	11,4	10340075165
	12000	90x148	11	13,4	12340090148
	15000	75x225	8	16,0	15340075225
	15000	90x170	8	15,8	15340090170
	18000	90x220	7	19,2	18340090220
450	18000	90x230	7	19,6	18340090230
	470	35x55	237	1,4	47145035055
	560	35x70	199	1,7	56145035070
	560	40x55	199	1,7	56145040055
	680	35x80	164	2,0	68145035080
	820	40x70	136	2,1	82145040070
	820	35x100	136	2,2	82145035100
	1000	40x80	111	2,4	10245040080
	1000	45x70	111	2,3	10245045070
	1200	40x100	93	2,9	12245040100
	1200	50x70	93	2,7	12245050070
	1500	50x80	74	3,2	15245050080
	1500	45x100	74	3,3	15245045100
	1800	50x100	62	3,8	18245050100
	2200	65x80	51	5,0	22245065080
	2700	65x100	41	6,1	27245065100
	3900	65x130	29	8,1	39245065130
	3900	75x100	29	6,3	39245075100
	4700	75x115	24	7,3	47245075115
	5600	75x145	20	8,7	56245075145
6800	75x165	16	10,1	68245075165	
8200	90x148	14	11,9	82245090148	
10000	75x225	11	13,9	10345075225	
12000	90x170	9	15,1	12345090170	
500	15000	90x220	7	18,8	15345090220
	15000	90x230	7	19,1	15345090230
	390	35x55	286	1,3	39150035055
	470	40x55	237	1,5	47150040055
	560	35x70	199	1,7	56150035070
	680	35x80	164	2,0	68150035080
	680	40x70	164	1,9	68150040070
	820	35x100	136	2,2	82150035100
	820	40x80	136	2,2	82150040080
	820	45x70	136	2,1	82150045070
	1000	50x70	111	2,7	10250050070
	1200	40x100	93	2,7	12250040100
	1200	50x80	93	2,8	12250050080
	1200	45x100	93	2,9	12250045100
	1800	50x100	62	3,8	18250050100
	2200	65x80	51	5,0	22250065080
	2700	65x100	41	6,1	27250065100

Stand: 12/2019

85°C

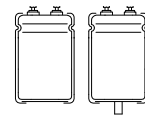

GM

Rated voltage $U_R$ [V]	Rated cap. $C_R$ [ $\mu$ F]	Case size D x L [mm]	Typ. ESR 100 Hz, 20°C [m $\Omega$ ]	Ripple current IR~ 100 Hz, 85°C [A]	Order code
					Plain base: GMA...
					Stud mounting: GMB...
500	3300	75x100	34	7,3	33250075100
	3900	65x130	29	6,4	39250065130
	4700	75x115	24	7,3	47250075115
	5600	75x145	20	8,7	56250075145
	6800	75x165	16	10,1	68250075165
	8200	90x148	14	11,9	82250090148
	10000	75x225	11	13,9	10350075225
	10000	90x170	11	13,8	10350090170
	15000	90x220	7	18,8	15350090220
	15000	90x230	7	19,1	15350090230

■ USEFUL LIFE AS A FUNCTION OF AMBIENT TEMPERATURE AND ACTUAL RIPPLE CURRENT

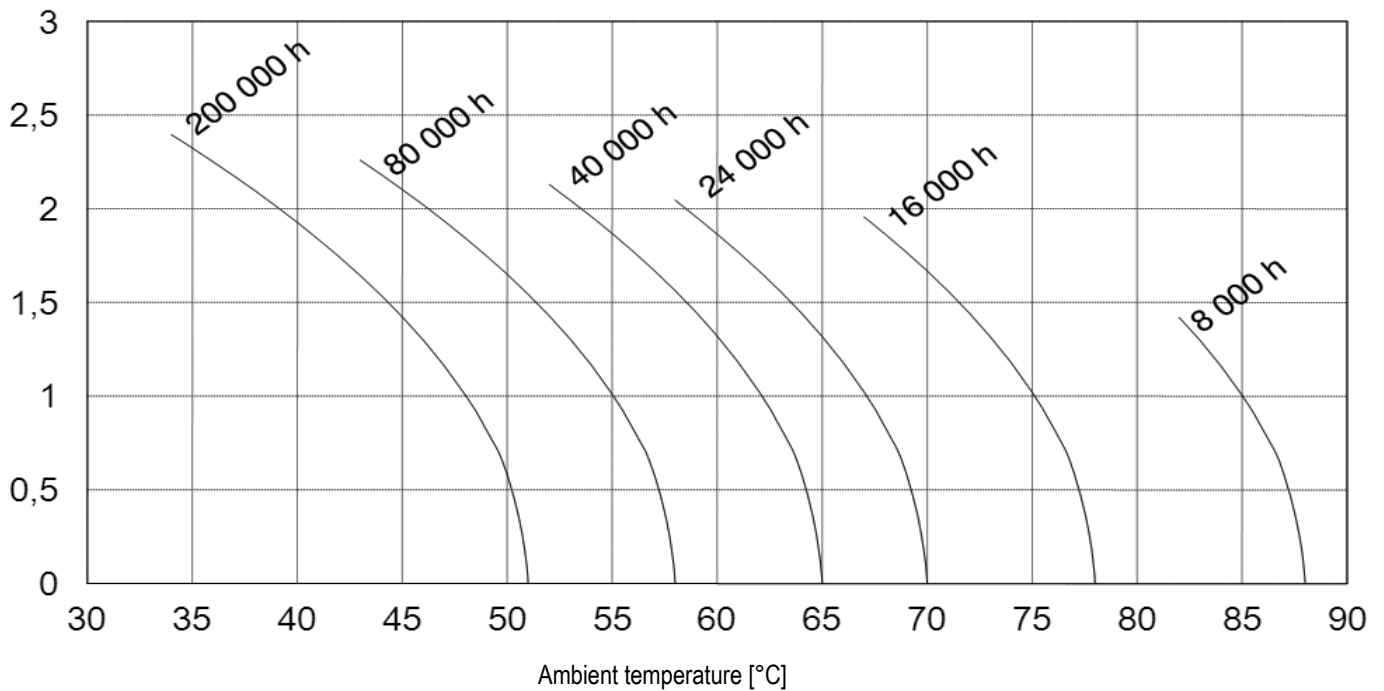

Stand: 12/2019