

# E37603

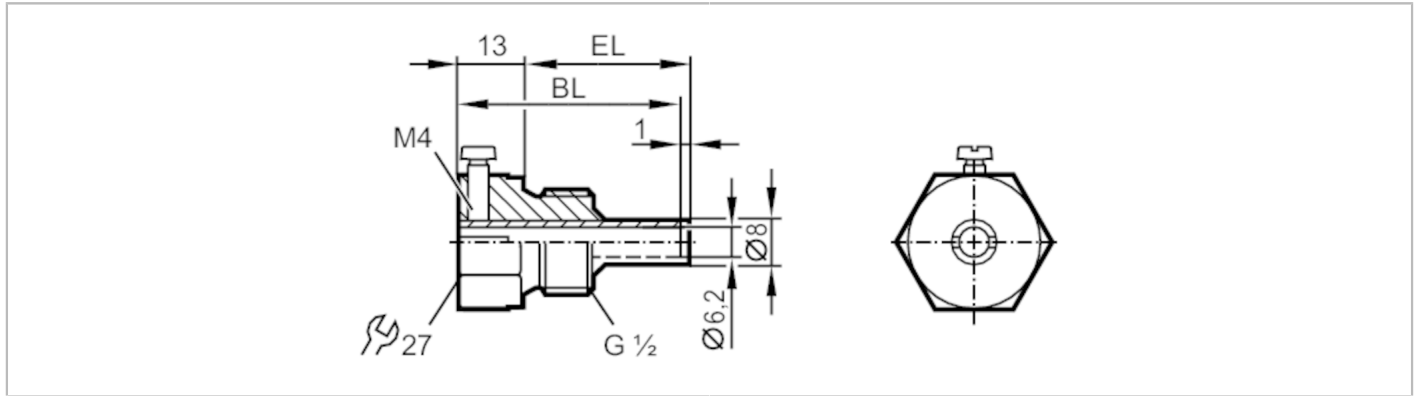

## Thermowell for temperature sensors

THERMOWELL, D6/ 6mm/L=50



### Application

Design	for temperature sensors EL = 50 mm
Pressure rating [bar]	100
Note on pressure rating	< 250 °C

### Mechanical data

Weight [g]	98
Materials	stainless steel (1.4571/316Ti)
Sensor connection	Ø 6 mm
Process connection	G 1/2
Installation length EL [mm]	33
Bore length BL [mm]	45

### Remarks

Pack quantity	1 pcs.
---------------	--------